

# ICSD

International Conference  
on  
Sustainable Development

## BOOK OF PROCEEDING

19 – 23 OCTOBER 2016

SKOPJE-MACEDONIA

ISBN: 978-605-66262-7-2

*ORGANIZED BY*



*SUPPORTED BY*



***Edited by***

***Prof. Dr. Özer Çınar***

***Published, 2016 info@icsd.eu***

*This work is subject to copyright. All rights are reserved, whether the whole or part of the material is concerned. Nothing from this publication may be translated, reproduced, stored in a computerized system or published in any form or in any manner, including, but not limited to electronic, mechanical, reprographic or photographic, without prior written permission from the publisher.*

*www.icsd.eu*

*info@icsd.eu*

*The individual contributions in this publication and any liabilities arising from them remain the responsibility of the authors. The publisher is not responsible for possible damages, which could be a result of content derived from this publication.*

**ISBN: 978-605-66262-7-2**

## SCIENTIFIC COMMITTEE

**Prof.Dr. Abdulrezzak Memon**  
*International University of Sarajevo*

**Prof.Dr. Adisa Parić**  
*University of Sarajevo*

**Prof.Dr. Adnan Çelik**  
*Selçuk University*

**Prof.Dr. Ana Vovk-Korže**  
*University of Maribor*

**Prof.Dr. Archie Caroll**  
*University of Georgia*

**Prof.Dr. Aslı YÜKSEL MERMÖD**  
*Marmara University*

**Prof.Dr. Birol Kovancilar**  
*Celal Bayar University*

**Prof.Dr. Blerim Reka**  
*South-East European University,  
Macedonia*

**Prof.Dr. Cumali Kınacı**  
*Istanbul Technical University*

**Prof.Dr. Dragan Vinterhalter**  
*University of Belgrade*

**Prof.Dr. Dragutin T. Mihailović**  
*University of Novi Sad*

**Prof.Dr. Ebru Çağlayan Akay**  
*Marmara University*

**Prof.Dr. Edina Muratović**  
*University of Sarajevo*

**Prof.Dr. Emine ÇOBANOĞLU**  
*Marmara University*

**Prof.Dr. Erkan Şahinkaya**  
*Istanbul Medeniyet University*

**Prof.Dr. Esad Prohic**

*University of Zagreb, Croatia*

**Prof. Dr. Fadbi Osmani**  
*Tetova State University*

**Prof.Dr. Flutura Kalemi**  
*Agricultural University of Tirana*

**Prof.Dr. Halil Hasar**  
*Firat University*

**Prof.Dr. Ilia Ninka**  
*Tetova State University*

**Prof.Dr. Ismail Bakan**  
*Kahramanmaraş Sutcu Imam  
University*

**Prof.Dr. Jasna Huremović**  
*University of Sarajevo*

**Prof.Dr. Lada Lukić Bilela**  
*University of Sarajevo*

**Prof.Dr. Lindita Milo (Lati)**  
*University of Tirana*

**Prof.Dr. Lukman Thalib**  
*Kuwait University*

**Prof.Dr. M. Asghar Fazel**  
*University of Environment*

**Prof.Dr. M. M. Sulphy**  
*University of Kerala in India*

**Prof.Dr. Mehmet Karataş**  
*Necmettin Erbakan University*

**Prof.Dr. Mustafa Erdoğan**  
*Marmara University*

**Prof.Dr. Mustafa Özbilgin**  
*Brunel University*

**Prof.Dr. Özer Çınar**  
*Yıldız Technical University*

**Prof.Dr. Phoebe Koundouri**  
*Ath. Uni. of Econ. and Business*

**Prof.Dr. Refika Bakoğlu**  
*Marmara University*

**Prof.Dr. Rifat Skrijelj**  
*University of Sarajevo*

**Prof.Dr. Samir Đug**  
*University of Sarajevo*

**Prof.Dr. Seniye Umit Firat**  
*Marmara University*

**Prof.Dr. Suad Bećirović –**  
*Int.University of Novi Pazar*

**Prof.Dr. Suzana Guxholli**  
*University of New York in Tirana*

**Prof.Dr. Šemsudin Plojović**  
*International University of Novi  
Pazar*

**Prof.Dr. Tanay Sitki Uyar**  
*Marmara University*

**Prof.Dr. Tanju Karanfil**  
*Clemson University*

**Prof.Dr. Thankom Arun**  
*Lancashire Business School*

**Prof.Dr. W.Kittilaksanawong**  
*Saitama University, Japan*

**Prof.Dr. Vullnet Ameti**  
*Tetova State University*

**Prof.Dr. Yahia Zoubir**  
*KEDGE Business School*

## SCIENTIFIC COMMITTEE (continue)

**Prof.Dr. Zehra Semra Can**

*Marmara University*

**Assoc. Prof.Dr. Agim Mamuti**

*University of New York in Tirana  
(UNYT)*

**Assoc. Prof.Dr. Ayla Öncer**

*Marmara University*

**Assoc. Prof.Dr. Christina Anne  
Stringer**

*The University of Auckland, New  
Zealand*

**Assoc. Prof.Dr. Elma Elfić-  
Zukorlić**

*International University of Novi  
Pazar*

**Assoc. Prof.Dr. Festim Halili**

*Tetova State University*

**Assoc. Prof.Dr. Mehmed Meta**

*International University of Novi  
Pazar*

**Assoc. Prof.Dr. Mehmet Alkan**

*Yıldız Technical University*

**Assoc. Prof.Dr. Mostafa Jafari**

*Res. Inst. of Forests and Rangelands*

**Assoc. Prof.Dr. Nuran  
Çıkcıkoğlu Yıldırım**

*Tunceli University*

**Assoc. Prof.Dr. Nusret  
Drešković**

*University of Sarajevo*

**Assoc. Prof.Dr. Olcay Bige  
Yıldırım**

*Marmara University*

**Assoc. Prof.Dr. Raman Ismaili**

*Tetova State University*

**Assoc. Prof.Dr. Senija Tahirović**

*International University of Sarajevo*

**Assist. Prof.Dr. Ahmad Talebi**

*University of Environment*

**Assist. Prof.Dr. Barış Yılmaz**

*Marmara University*

**Assist. Prof.Dr. Fouzi Tabet**

*German Biomass Research Center*

**Assist. Prof.Dr. Konstantinos  
Chalvatzis**

*Konstantinos Chalvatzis*

**Assist. Prof.Dr. Mark R. Murphy**

*The University of Scranton*

**Assist. Prof.Dr. Mehmet Ganić**

*International University of Sarajevo*

**Assist. Prof.Dr. Mostafa Panahi**

*Islamic Azad University*

**Assist. Prof.Dr. Sasan Rabieh**

*Shahid Beheshti University*

**Assist. Prof.Dr. Senad Busatlic**

*International University of Sarajevo*

**Assist. Prof.Dr. Ševkija Okerić**

*University of Sarajevo*

**Assist. Prof.Dr. Tuba Boz**

*International University of Sarajevo*

**ORGANIZATION COMMITTEE**

**Conference Chairs**

**Prof. Dr. Özer Çınar**

*Yıldız Technical University*

**Prof. Dr. Vullnet Ameti**

*Rector of Tetova State University*

**Members of the Committee**

**Prof. Dr. Refika Bakoğlu**

*Marmara University*

**Prof. Dr. M. Asghar Fazel**

*University of Environment*

**Prof. Dr. Lukman Thalib**

*Kuwait University*

**Assoc. Prof. Dr. Agim Mamuti**

*University of New York in Tirana (UNYT)*

**Assoc. Prof. Dr. Nusret Drešković**

*University of Sarajevo*

**Mr. Asst. Faton Shabani**

*Tetova State University*

**Mr. Asst. Hatibe Deari-Zeqiri**

*Tetova State University*

**Mr. Asst. Ibrahim Neziri**

*Tetova State University*

**Mr. Asst. Kushtrim Ahmeti**

*Tetova State University*

**Alma Ligata**

*Zenith Group*

**Ismet Uzun**

*Zenith Group*

**Musa Kose**

*Zenith Group*

**Shkurte Luma-Osmani**

*Tetova State University*

## **Welcome to ICSD 2016**

On behalf of the organizing committee, we are pleased to announce that the 2thInternational Conference on Sustainable Development (ICSD-2016) is held from October 19 to 23, 2016 in Skopje-MACEDONIA. ICSD 2016 provides an ideal academic platform for researchers to present the latest research findings and describe emerging technologies, and directions in Sustainable Development issues. The conference seeks to contribute to presenting novel research results in all aspects of Sustainable Development. The conference aims to bring together leading academic scientists, researchers and research scholars to exchange and share their experiences and research results about all aspects of Sustainable Development. It also provides the premier interdisciplinary forum for scientists, engineers, and practitioners to present their latest research results, ideas, developments, and applications in all areas of Engineering and Natural Sciences. The conference will bring together leading academic scientists, researchers and scholars in the domain of interest from around the world. ICSD 2016 is the oncoming event of the successful conference series focusing on Sustainable Development. The scientific program focuses on current advances in the research, production and use of Engineering and Natural Sciences with particular focus on their role in maintaining academic level in Engineering and Applied Sciences and elevating the science level. The conference's goals are to provide a scientific forum for all international prestige scholars around the world and enable the interactive exchange of state-of-the-art knowledge. The conference will focus on evidence-based benefits proven in clinical trials and scientific experiments.

**Best regards,**

**Chairman of Conference**

**Prof. Dr. Özer ÇINAR**

# INDEX

<b>PAPER NAME</b>	<b>PAGE</b>
<b>EFFECTS OF IRON CHLORIDE/ZEOLITE ON GST OF RAINBOW TROUT (ONCORHYNCHUS MYKISS)'S KIDNEY TISSUE</b> <i>(Gonca Alak, Arzu Ucar, Veysel Parlak, Muhammed Atamanalp)</i>	<b>1</b>
<b>EFFECTS OF CHLORPYRIFOS ON G6PD OF RAINBOW TROUT (ONCORHYNCHUS MYKISS)'S TISSUE</b> <i>(Muhammed Atamanalp, Veysel Parlak, Gonca Alak, Esat Mahmut Kocaman)</i>	<b>4</b>
<b>THE EFFECT OF AFFORESTATION SITE CONDITIONS IN MALATYA REGION ON GROWTH PERFORMANCE OF TAURUS CEDAR (CEDRUS LIBANI A. RICH.)</b> <i>(Atilla Atik)</i>	<b>7</b>
<b>MODIFIED SPWM TO REDUCE SWITCHING LOSSES IN STANDBY UPS SYSTEMS FOR SUSTAINABLE ENERGY</b> <i>(Mustafa Inci, Mehmet Buyuk, Mehmet Tumay)</i>	<b>11</b>
<b>A COMPREHENSIVE REVIEW OF POWER QUALITY PROBLEMS AND SOLUTION TECHNIQUES IN GRID CONNECTED WIND SYSTEMS</b> <i>(Mustafa Inci, Mehmet Buyuk, Mehmet Tumay)</i>	<b>18</b>
<b>THE PERFORMANCE IMPROVEMENT OF DVR BASED GRID CONNECTED WIND ENERGY SYSTEMS FOR SUSTAINABLE ENERGY</b> <i>(Mehmet Buyuk, Mustafa Inci, Adnan Tan, Mehmet Tumay)</i>	<b>24</b>
<b>IMPROVED SRF TO EXTRACT HARMONICS IN ACTIVE POWER FILTERS FOR SINGLE PHASE SYSTEMS</b> <i>(Mustafa Inci, Mehmet Buyuk, Mehmet Tumay)</i>	<b>30</b>
<b>FIELD CALIBRATION OF NEUTRON MOISTURE METER FOR MEASURING SOIL WATER CONTENT IN LOAMY SOILS</b> <i>(Halil Kirnak, Yasemin Akpınar, Ali Unlukara, Hasan Ali Irik)</i>	<b>35</b>
<b>EVALUATION OF ACCOUNTING EDUCATION OFFERED IN FORMAL EDUCATION IN TURKEY IN TERMS OF INFRASTRUCTURE AND HUMAN STANDARDS -A MODEL PRACTICE IN ERZURUM</b> <i>(Resat Karcioğlu, Sakir Dızman, Abdulkadir Kaya)</i>	<b>40</b>
<b>LINKING URBAN SECURITY AND REGIONAL DEVELOPMENT: OPERATIONALIZING SECURITY-DEVELOPMENT NEXUS WITHIN REGIONAL DEVELOPMENT AGENCIES</b> <i>(Ahmet Barbak)</i>	<b>46</b>
<b>EFFECTS OF ENERGY DRINKS WITH ALCOHOL CONSUMPTION</b> <i>(Mumin Polat, Serkan Koksoy, Canan Demir Barutcu, Gulcihan Aybike Dilek)</i>	<b>53</b>
<b>AN EVALUATION ON THE ATTRACTIVENESS OF TURKISH ECONOMY IN TERMS OF FOREIGN DIRECT INVESTMENTS</b> <i>(Ilhan Gullu, Nazife Ozge Kilic)</i>	<b>56</b>
<b>SINGLE AND COMBINED EFFECTS OF COPPER AND NICKEL ON NITRIFICATION ORGANISMS IN BATCH UNITS</b> <i>(Sukru Aslan)</i>	<b>66</b>
<b>THE EFFECTS OF BUILDING MATERIALS ON BUILDING BIOLOGY AND THE RESULTANT AIR QUALITY</b> <i>(Nil Kokulu, Seden Acun Ozgunler)</i>	<b>71</b>
<b>DATA RATE MEASURES FOR 4G NETWORKS IN ALBANIA</b> <i>(Julian Imami)</i>	<b>77</b>



<b>DESIGN OF A SUSTAINABILITY PROGRAM FOR HIGH SCHOOL STUDENTS AT THE UNIVERSITY OF GUADALAJARA</b> <i>(Daniel A. Herrera Bojórquez)</i>	<b>82</b>
<b>THE EFFECT OF SERVICE QUALITY IN TOURISM BUSINESSES ON CUSTOMER SATISFACTION</b> <i>(Murat Kocyigit, Ercan Aktan)</i>	<b>87</b>
<b>UNIVERSITY STUDENTS PROTECTING AND CONSERVATING SEA TURTLES IN THE SHORES OF MEXICO</b> <i>(Blanca A. B. Martínez, R. A. BCoronasánchez-M. Antonio Gómezramírez, D. A. HerreraBojórquez)</i>	<b>93</b>
<b>CHANGED CIRCUMSTANCES AS GROUND FOR NON-PERFORMANCE OF CONTRACTS (AN OVERVIEW OF MACEDONIAN CONTRACT LAW)</b> <i>(Faton Shabani)</i>	<b>101</b>
<b>AGRICULTURAL DIFFUSE POLLUTION AND SUSTAINABILITY IN ERGENE BASIN</b> <i>(Gokcen Bayrak Yilmaz, Damla Atik, Nuket Sivri)</i>	<b>104</b>
<b>IMPORTANCE OF SUSTAINABILITY AND DEVELOPMENT IN TERMS OF MAIZE (ZEA MAYS.L.) GROWN WITH DRIP IRRIGATION</b> <i>(Aybuke Kaya, Dilek Bostan Budak)</i>	<b>112</b>
<b>USER DIMENSION ON SOCIO-CULTURAL SUSTAINABILITY OF TRADITIONAL SETTLEMENTS: KALEICI/EDIRNE/TURKEY</b> <i>(Damla Atik, Gokcen Bayrak Yilmaz)</i>	<b>117</b>
<b>CHILDREN'S ECONOMIC ACTIVITIES IN AGRICULTURE IN TURKEY</b> <i>(Tuğçe Uğur, Kasım Eren Tuna, Nermin Bahsi)</i>	<b>125</b>
<b>INFLUENCE OF EARLY OTTOMAN URBAN PATTERN IN BURSA ON THE BALKAN CITIES: SKOPJE CASE</b> <i>(Alper Gonul, Selen Durak, Tulin Vural Arslan)</i>	<b>131</b>
<b>AN ANTI-COLONIAL APPROACH TO SUSTAINABLE DEVELOPMENT: ECONOMIC STRUCTURAL ADJUSTMENT AND WOMEN IN AGRICULTURE IN AFRICA</b> <i>(Asli Ege)</i>	<b>139</b>
<b>SOME PHYSICAL PROPERTIES OF CEMRE (TRITICUM AESTIVUM L.) AND SARICANAK-98 (TRITICUM DURUM DESF.) WHEAT SEEDS</b> <i>(Cevdet Saqlam, Necati Cetin)</i>	<b>145</b>
<b>SORGHUM IN PHYTOREMEDIATION</b> <i>(Ridvan Temizgul, Mahmut Kaplan, Semih Yilmaz)</i>	<b>153</b>
<b>INTERNET ACCESS AND DIGITAL SKEPTICISM: A PRELIMINARY ANALYSIS</b> <i>(Naciye Guliz Uğur, Merve Turkmen Barutcu)</i>	<b>157</b>
<b>BIOMETRIC SOLUTIONS FOR IS SECURITY</b> <i>(Naciye Guliz Uğur, Merve Turkmen Barutcu)</i>	<b>163</b>
<b>POTENTIAL MISTAKES MADE IN DESIGN OF NATURAL WASTEWATER TREATMENT SYSTEMS (CONSTRUCTED WETLANDS)</b> <i>(Zeki Gokalp, Sedat Karaman, Belgin Cakmak)</i>	<b>167</b>
<b>ANALYSIS OF SUSTAINABILITY REPORTING IN THE TURKEY AUTOMOTIVE SECTOR</b> <i>(Gulcin Yildirim, Tuğçe Uzun Kocamis, Emine Mukaddes Kistan)</i>	<b>174</b>
<b>EARTHQUAKES AND RURAL STRUCTURES</b> <i>(Sedat Karaman, Zeki Gokalp)</i>	<b>181</b>
<b>QUANTITATIVE AND QUALITATIVE ASPECTS OF REMITTANCES, COMPARATIVE ANALYSIS OF ALBANIA AND MACEDONIA</b> <i>(Aqim Mamuti, Mehmed Ganic)</i>	<b>186</b>

<b>EFFECTS OF DEFICIT IRRIGATION ON SOME PHYSIOLOGICAL PARAMETERS OF PUMPKIN SEED</b> <i>(Hasan Ali Irik, Halil Kirnak, Abdullah Ulas)</i>	192
<b>SOCIO-PSYCHOLOGICAL ISSUES AND THEIR CONSEQUENCE ON FARMERS' BEHAVIOURAL INTENTION TOWARDS SUSTAINABLE PRACTICES</b> <i>(Woldegebrial Zeweld, Guido Van Huylenbroeck, Girmaytesfay, Stijn Speelman)</i>	199
<b>EFFECTS OF NUTRITION EDUCATION ON GENERAL HEALTH AND NUTRITIONAL STATUS OF PREGNANT WOMEN</b> <i>(Meltem Soylu)</i>	204
<b>MINERAL CONTENTS OF WEED CROPS IN CENTRAL ANATOLIAN REGION</b> <i>(Mahmut Kaplan, KağanKokten Tuğay Ayasan, Alperen Meral)</i>	213
<b>A RESEARCH ON INTERNAL MARKETİNG AND MOTIVATION: EMPLOYEE EVALUTION OF TRAINİNG AND DEVELOPMENT PROGRAMMES İN BANKİNG SECTOR</b> <i>(Kenan Gullu, Onur Celik, Tuğçe Gullu, Hamdi Bayram)</i>	219
<b>EFFECT OF SOCIAL CAPITAL ON INNOVATIVE FORMATIONS AND INNOVATİVNESS ABILITY OF INSTITUTIONS: A RESEACRH ABOUT A STATE AND A FOUNDATION UNIVERSITY PROVIDE TRAINİNG İN KONYA</b> <i>(E.Nihan Cici Karaboğa, Nezahat Kocyiğit, A.Elif Yazğan, Kazim Karaboğa)</i>	225
<b>THE EFFECT OF THE PSYCHOLOGICAL CONTRACT PERCEPTION AND ITS BREACH ON THE ORGANIZATIONAL COMMITMENT: A RESEARCH İN A COMPANY OPERATING İN THE MANUFACTURING SECTOR</b> <i>(Nezahat Kocyiğit, E. Nihan Cici Karaboğa, A.Elif Yazğan)</i>	233
<b>SPATIAL DISTRIBUTION OF MEAN WAVE ENERGY FLUX OVER THE BLACK SEA</b> <i>(Adem Akpınar, Bilal Binqalbalı, HalidJafalı)</i>	241
<b>MANAGING SUPPLY CHAIN SUSTAINABILITY AND RISKS: A REAL CASE STUDY İN TURKEY</b> <i>(Sukran Seker)</i>	246
<b>EFFECTS OF ENSILING TIME ON CHEMICAL COMPOSITIONS OF MAIZE SILAGES</b> <i>(Ismail Ulqer, Mahmut Kaplan)</i>	250
<b>SOME FRUIT CHARACTERISTICS OF SUPERIOR WALNUT GENOTYPES COLLECTED FROM CAPPADOCIA REGION OF TURKEY</b> <i>(Aybey İmamoğlu, Aydın Uzun)</i>	253
<b>COMPARISON OF THE CALIBRATED SWAN MODELS' PERFORMANCES FORCING WITH DIFFERENT WINDS İN THE BLACK SEA</b> <i>(Adem Akpınar, Bilal Binqalbalı)</i>	257
<b>APPLICATION OF PRODUCT PLACEMENT AND FUNCTION OF ADVERTISERS İN TURKEY</b> <i>(Fikret Yazıcı, Vahit İlhan)</i>	266
<b>ALLELOPATHIC POTENTIAL OF SOME AROMATIC PLANT ESSENTIAL OILS ON CHENOPODIUM ALBUM L. SEED GERMINATION</b> <i>(Doğan Isik)</i>	270
<b>DETERMINATION OF WEED SPECIES İN GARLIC (ALLIUM SATIVUM L.) FIELDS İN TASKOPRU COUNTY İN KASTAMONU PROVINCE İN TURKEY</b> <i>(Doğan Isik)</i>	276
<b>THE İMPACT OF MACROECONOMIC AND BANK SPECIFIC FACTORS ON ALBANIAN NON-PERFORMING LOAN</b> <i>(Klejda Gabeshi)</i>	280
<b>ARE NATURAL DYES ENVIRONMENTALLY AND ECOLOGICALLY FRIENDLY ?</b> <i>(Ayşe Uygur)</i>	287

<b>THE FUTURE OF ORGANIC FIBERS</b> <i>(Ayse Uygur)</i>	<b>293</b>
<b>MIGRATION OF WOMEN FROM RURAL TO URBAN IN TURKEY</b> <i>(Nermin Bahs, Dilek Bostan Budak)</i>	<b>306</b>
<b>USE OF SOLAR ENERGY ON AGRICULTURAL LANDS IN TURKEY</b> <i>(Ufuk Gultekin, DilekBostanBudak)</i>	<b>305</b>
<b>A COLLABORATIVE STUDY ON THE PHSICAL AND SOCIAL MEANING OF DOORBELL: PROBLEMS AND SOLUTION SUGGESTIONS</b> <i>(OzanSoyupak, HumanurBaqli)</i>	<b>309</b>
<b>CLIMATE CHANGE AND IRRIGATION MANAGEMENT IN TURKEY</b> <i>(Belqin Cakmak, Zeki Gokalp, Sedat Karaman)</i>	<b>317</b>
<b>FORM BALCONY TO FRENCH WINDOW: EFFECTS OF URBAN TRANSFORMATION ON LOCAL PEOPLE OF SUADIYE AND BOSTANCI DISTRICTS</b> <i>(Ilayda Soyupak)</i>	<b>324</b>
<b>PHOSPHORUS LOSSES INFLUENCED BY IRRIGATION EFFICIENCY, TILLAGE, AND PHOSPHORUS RATE</b> <i>(Osman Sonmez)</i>	<b>330</b>
<b>EVALUATION OF DROUGHT MANAGEMENT IN TURKEY</b> <i>(Belqin Cakmak, ZekiGokalp,Sedat Karaman)</i>	<b>335</b>
<b>THE ROLE AND THE IMPACT OF DIGITAL CERTIFICATE AND DIGITAL SI)GNATURE IN IMPROVING SECURITY DURING DATA TRANSMISSION</b> <i>(Nexhibe Seifuli - Ramadani, Verda Misimi, Erenis Ramadani, Florim Idriz.)</i>	<b>340</b>
<b>BACILLUS THURINGIENSIS PARASPORINS AND THEIR USE IN CONTROLLING CANCER CELLS</b> <i>(Semih Yilmaz, Aysun Cetin, RidvanTemizgul)</i>	<b>345</b>
<b>COMPARİSON STUDIES OF E-LEARNING LMS'ES IN HIGHER EDUCATION INSTITUTIONS IN THE REPUBLIC OF MACEDONIA</b> <i>(Shkurte Luma-Osmani, Florim Idriziartrim Kjamilji)</i>	<b>350</b>
<b>AN ENGINEERING APPROACH TO DEVELOP A MATHEMATICAL MODEL FOR SUSTAINABLE POPULATION</b> <i>(Nukhet Sazak, Haldun Abdullah)</i>	<b>358</b>
<b>ENVIRONMENTAL POLLUTION OF COASTAL WATERS DURING VLORA-SARANDA AND EVALUATION OF LEVEL OF POLLUTION</b> <i>(Dr.Dafina Nazaj, Msc. Simo Ribaj)</i>	<b>361</b>
<b>SUSTAINABILITY IN HOSPITALITY INDUSTRY IN TURKEY: NATIONAL AND INTERNATIONAL APPLICATIONS</b> <i>(Huseyin Cetin, Zekeriya Yetis)</i>	<b>367</b>
<b>EMPIRICAL ANALYSIS ON THE RUNNING TIME OF A SEARCHING ALGORITHM, CHUNK ALGORITHM</b> <i>(Gazmend Xhaferi, Florinda Imeri, Flamure Sadiku, Aqon Memeti)</i>	<b>374</b>
<b>ETHNOMEDICINAL ASPECTS OF SOME WEEDS OF RAHOVES REGION, KOSOVO</b> <i>(Haxhi Halilaj, Pirrolcka, Avdyl Bajrami, Robert Damo)</i>	<b>380</b>
<b>EVULATION OF PHENOLOGICAL AND POMOLOGICAL CHARACTERS OF SOME ALMOND GENOTYPES AND CULTIVARS IN TURKEY</b> <i>(Hasan Pinar, Mustafa Bircan, Aydin Uzun, Omer Faruk Coskun· Mehmet Yaman)</i>	<b>385</b>

<b>A THREE-DIMENSIONAL MODEL OF SINGLE PEM FUEL CELL HAVING TRIPLE-SERPENTINE FLOW CHANNEL DEVELOPED WITH CFD</b> <i>(Elif Eker Kahveci, Imdat Taymaz)</i>	<b>389</b>
<b>YIELD AND QUALITY EFFECTS OF NITROGEN APPLIED AT DIFFERENT LEVELS AND PERIODS ON SUGARBEET</b> <i>(Fatma Gokmen Yilmaz, Sait Gezgin, Mustafa Harmakaya)</i>	<b>399</b>
<b>DATA MINING TECHNIQUES IN DATABASE SYSTEMS</b> <i>(Ledion Lico)</i>	<b>404</b>
<b>THE GUZELCEHISAR-BARTIN COASTAL LANDSCAPE HERITAGE PROJECT</b> <i>(Canan Cengiz, Bulent Cengiz)</i>	<b>411</b>
<b>A SPATIAL ANALYSIS OF A TRADITIONAL STREET IN AMASRA, TURKEY</b> <i>(Bulent Cengiz)</i>	<b>420</b>
<b>ADVANCES IN REFRACTANCE WINDOW DRYING OF FOODSTUFFS</b> <i>(Inci Cinar)</i>	<b>428</b>
<b>THE USE OF MEMBRANE PROCESSES TO PROMOTE SUSTAINABLE ENVIRONMENTAL PROTECTION PRACTICES</b> <i>(Abdullah Kizilet, Mehmet Akif Veral, Amar Cemanovic, Onur Isik, Majid Bahramian, Ozer Cinar)</i>	<b>432</b>
<b>SENSATIONS IN PEDIATRIC DEVELOPMENT</b> <i>(Mudriye Yildiz Bicakci, Hulya Tercan)</i>	<b>438</b>
<b>SOCIAL MEDIA USE OF LARGE CORPORATIONS: TURKEY FORTUNE 500 ANALYSIS</b> <i>(Merve Turkmen Barutcu, Naciye Guliz Ugur)</i>	<b>444</b>
<b>MOBILE BANKING ACCEPTANCE: A MODEL SUGGESTION</b> <i>(Naciye Guliz Ugur, Merve Turkmen Barutcu)</i>	<b>449</b>
<b>MOBILE AIR QUALITY INDEX MONITORING SYSTEM</b> <i>(Emilija Janchevska, Marin B. Marinov, Ivan Topalov, Georgi Nikolov)</i>	<b>456</b>
<b>AN ETHNOBOTANICAL STUDY OF PLANTS USED FOR TEA MAKING IN KOSOVO AND ALBANIA</b> <i>(Avdy/Bajrami, Pirrolcka, Robert Damo)</i>	<b>463</b>

# Effects of Iron Chloride/Zeolite on GST of Rainbow Trout (*Oncorhynchus mykiss*)'s Kidney Tissue

Gonca Alak<sup>1</sup>, Arzu Ucar<sup>1</sup>, Veysel Parlak<sup>1</sup>, Muhammed Atamanalp<sup>1</sup>

---

## Abstract

Aquatic ecosystems have been negatively affected by the contamination of ground and surface waters as a result of various activities. Due to the ferrous chloride (FeCl<sub>2</sub>), which is used as the reducing agent for the organic synthesis reactions in the contamination of water column and sediment, iron salts may be very toxic for some aquatic organisms. In order to minimize these effects, natural products such as zeolite have been widely used in recently years.

For this reason, rainbow trout were exposed to FeCl<sub>2</sub> and/or zeolite ((FeCl<sub>2</sub> (0.002 mg/l)(A), FeCl<sub>2</sub>+zeolite (0.002 mg/l+1 gr/l) (B), zeolite (1 gr/l) (C) and control (without FeCl<sub>2</sub> and/or zeolite (D)). for 28 days and their oxidative stress responses were investigated. At the end of the treatment period, glutathione-S-transferase (GST) activity was determined in the samples taken from kidney. GST values for kidney tissues were found statistically important in the control and treatment groups ( $p < 0.01$ ).

**Keywords:** Ferrous chloride; zeolite; fish; toxicity; oxidative stress; enzyme; detoxificant

---

## 1. INTRODUCTION

Fish are generally used as bio-indicators for the determination of the conditions and changes of the aquatic environment. Thus, the degree and the type of the responses that fish give to these changes in the ecosystem at different levels should be known [1,2].

Studies on the metabolic and enzymatic activities of aquatic organisms are substantial and essential in terms of the determination of the ecological effects of the contaminants in fresh water and marine environment. Particularly enzymes, as physiological biochemical indicators, are used for the determination of the health condition of aquatic organisms before seriously affected by these contaminants [3,4].

Ferrous molecule (Fe<sup>+2</sup>), which has important roles in the living organism system, are found in different forms in the nature and mostly taken in through drinking water and food. It is known that the increase of Fe molecule in the body increases the radical production and also has a role in the increment of the hydroxyl radical, which is effective particularly in the lipid peroxidation of FeCl<sub>2</sub>, and hydroxyl- like radicals. Interest for the natural products has increased in order to prevent the negative effects of materials such as iron and aluminium in the regulation of water quality parameters, and studies on the utilization of alternative products have intensified. Among these products zeolites, which are found in large reserves in nature, are widely used for the elimination of heavy materials in water thanks to their sodium aluminosilicate and clay minerals, their ability of ion exchange and detraction of cations and their low cost [5-7].

Despite numerous studies on the usage of natural or synthetic products in the contamination, there is no study focusing on the materials of both group and on the determination of the oxidative stress response in the organism of aquatic system. The present study was modelled on rainbow trout, a locomotive specie of culture fishing, in an attempt to scrutinise the topic in question and to constitute a reference for the future studies.

## 2. MATERIAL AND METHOD

This research was obtained from Ataturk University, Faculty of Fisheries, Inland Water Fish Application and Research Center and the study was conducted at Fisheries Application and Research Center's Toxicology Experiment Unit during 28 days. Fiberglass tanks of 1 m diameter and 1 m depth with inclined tube drainage system and 40 rainbow trout (*Oncorhynchus mykiss*) of two years old and 165±25 g weight were utilized in the research. Filtered water was distributed to the tanks as no less than 0,5 l/min for kg fish. During the research, water temperature was measured as 11.5±2.5°C and dissolved oxygen was 9.1 mg/l. fish were randomly distributed to 8 tanks with 5 fish per tank. Two of the tanks were determined as control and the other 6 tanks were the treatment groups. FeCl<sub>2</sub> application dose LC5096 value was utilised and ½ (0.002 mg/l) of this dose was applied to tanks Billard and Roubaud [8]. Stock solutions of FeCl<sub>2</sub>, obtained from a company (Sigma), were prepared with ultra distilled water and were applied to the tanks with determined water volume according to the experiment procedure of renewed environment in the concentration to form this dose once every 12 hours. Zeolite was determined as 1 g/l covering the tank floor [5]. Control and treatment groups were designed as (FeCl<sub>2</sub> (0.002 mg/l)(A), FeCl<sub>2</sub>+zeolite (0.002 mg/l+1 gr/l) (B), zeolite (1 gr/l) (C) and control (without FeCl<sub>2</sub> and/or zeolite (D). Enzyme activities of GST were determined in kidney tissues for all groups.

### 2.1. Enzyme Analyses

---

<sup>1</sup> Corresponding author: Department of Aquaculture, Faculty of Fisheries, Ataturk University, TR-25240 Erzurum, Turkey.  
[galak@atauni.edu.tr](mailto:galak@atauni.edu.tr)

At the end of the trial, treatment and control group fish were euthanized by cervical section, their kidney tissues were taken and frozen in liquid nitrogen, and then kidney tissue samples were waited at -86 °C. Afterwards, weighted on a precision scale between the range of 0.5-1 g and completely washed in 0.9% NaCl solution. KH<sub>2</sub>PO<sub>4</sub> buffer solution of three times weight of the sample was added on the tissue samples splintered into small pieces. Samples were homogenised and centrifuged at 13000 rpm for an hour at 4 °C. Supernatants were taken and their enzyme activities were measured [9]. GST activity was evaluated using 1-chloro-2, 4 dinitrobenzene (CDNB) (Sigma) as substrate, as previously described by Habig et al. [10]. Change in absorbance at 340 nm was measured.

## 2.2. Statistical Analysis

The SPSS 20.0 software was used to perform all analyses and was assessed by Duncan. The data are expressed as the mean ± SD. Significant difference was acknowledged when  $p \leq 0.01$ .

## 3. RESULTS AND DISCUSSION

Heavy metals generally adhere to the functional groups of proteins such as imidazole, sulfhydryl, carboxyl, amino and peptide groups. In the enzyme-metal toxicity, toxic metal displaces a beneficial metal in the active area of the enzyme and becomes effective by binding to the inactive area of the metal [7].

The effect of FeCl<sub>2</sub> and zeolite applications on the fish antioxidant enzyme activities is given in Figure 1. It was determined that there were statistically important differences ( $p < 0.01$ ) between de treatment and control groups in terms of GST enzyme activities.

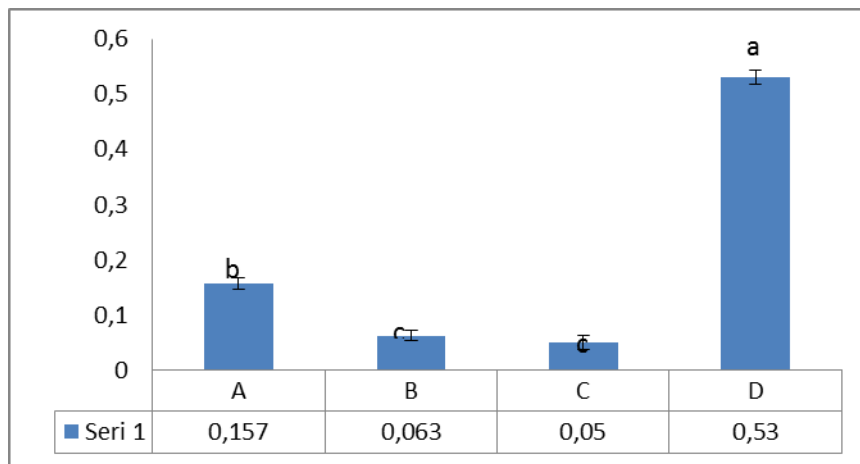

Figure.1. Lowercase superscripts (a, b) indicate significant differences among different tissue within each experimental treatment group, whereas superscripts in uppercase show significant differences among dosage. Each value is the mean±S.D. of ten individual observations. For treatment groups ((FeCl<sub>2</sub> 0.002 mg/l)(A), FeCl<sub>2</sub>+zeolite (0.002 mg/l+1 gr/l) (B), zeolite (1 gr/l) (C) and control (without FeCl<sub>2</sub> and/or zeolite) (D)). \*\*  $p < 0.01$  GST enzyme is EU mg protein<sup>-1</sup>

All organisms have systems for protecting themselves against the damaging effects of biotic and abiotic ROS [11]. In the present study, GST activities in the kidney altered after treatment (Figure 1)( $p < 0,01$ ). Especially in C, GST activities decreased in all groups. In the study, groups with zeolite showed a decrease in enzyme activities compared to control and groups with FeCl<sub>2</sub>, and this was attributed to the ion exchange ability of zeolite. Similarly, in a study on the protective effect of zeolite, it was reported that there were increases in the levels of some parameters (protein, RNA and glycogen level) and zeolite showed a protective effect [12].

As a result of the study, regular follow up of the contamination in natural water environments has been deemed necessary based on the obtained data. Moreover, effect mechanisms of the alternative natural products used and their effects on aquatic organisms should be determined by biochemical and molecular based studies, thus generate a database. Based on the study results, zeolite can be said to show a protective effect. However, although there are studies in the literature that we can compare our research results, there is no study about the effect of zeolite on the antioxidant systems of fish. This study, in which single and combinational usage of two products used in water purification (FeCl<sub>2</sub> and zeolite) constitutes a substantial reference for future studies.

## REFERENCES

- [1] M.S. Adams, Biological Indicators of Aquatic Ecosystem Stress, American Fisheries Society, Bethesda, Maryland, pp. 644, 2002.

- [2] D.L. Fabacher, and E.E. Little, Diversity of Fish, Early Observations and Descriptions, Fish in Experimentation G.K. Ostrander , Jr., Ed. The Laboratory Fish. Academic Press, London, 2000
- [3] J.A. Almeida, R.E. Barreto, E.L.B. Novelli, F.J. Castro, and S.E. Moron, "Oxidative stress biomarkers and aggressive behavior in fish exposed to aquatic cadmium contamination", *Neotropical Ichthyology*, vol.7(1), pp.103-108, 2009.
- [4] G. Alak, A.Y. Sönmez, and O. Hisar, "Effect of some pesticide on antioxidant enzyme activity of fish", *Journal of Agricultural Faculty of Atatürk University*, vol. 42 (1), 91-93, 2011.
- [5] M. Nicula, I. Bănăţean-Dunea, I. Gergen, M. Hărmănescu, E. Simiz, S. Pătruică, T. Polen, A. Marcu, M. Lunca and S. Szucs, "Effect of natural zeolite on reducing tissue bioaccumulation and cadmium antagonism related to some mineral micro- and macronutrients in Prussian carp (*Carassius gibelio*)", *AACL Bioflux*, vol. 3(3),171-179, 2010.
- [6] A. Dayangaç, A. Özkaya, M. Bahşi, B. Çiftçi, G. Akyıldız, and Ö. Yılmaz, "Linalool protects some unsaturated fatty acids in the rat liver and kidney against FeCl<sub>2</sub>-induced damage", *Düzce Üniversitesi Sağlık Bilimleri Enstitüsü Dergisi*, vol. 1(1), 12-17, 2011.
- [7] H.Y. Çoğun, and M. Şahin, "The effect of zeolite on reduction of lead toxicity in nil tilapia (*Oreochromis niloticus* Linnaeus, 1758) ", *Kafkas Univ Vet Fak Derg.*, vol. 18 (1), 135-140, 2012.
- [8] R. Billard, and P. Roubaud, "The effect of metals and cyanide on fertilization in rainbow trout (*Salmo gairdneri*) ", *Water Res.*, vol. 19(2), 209 – 214, 1985.
- [9] G. Alak, M. Atamanalp, A. Topal, H. Arslan, E. Oruç, and S. Altun, "Histopathological and biochemical effect of humic acid against cadmium toxicity in brown trout gills and muscle", *Turkish Journal of Fisheries and Aquatic Sciences*, 315-320, 2013.
- [10] W.H. Habig, M.J. Pabst, and W.B. Jakoby, "Glutathione s-transferases. the first enzymatic step in mercapturic acid formation", *J Biol Chem*, vol. 249(25), 7130-7139, 1974.
- [11] H. Xing, X. Wang, G. Sun, X. Gao, and S. Xu, "Effects of atrazine and chlorpyrifos on activity and transcription of glutathione S-transferase in common carp (*Cyprinus carpio L.*)", *Environ Toxicol Pharmacol*, vol. 33, 233–244, 2012
- [12] J. BalasuBramanian, and A. Kumar, "Effect of sodium arsenite on liver function related enzymes of cat fish *Heteropneustes fossilis* and its chelation by zeolite", *Ecotoxicol. Environ. Contam*, vol. 8(2), 53-58, 2013.

### Biography

Gonca Alak was born in Erzurum, Turkey, in 1981. She received the agricultural engineering degree in agriculture faculty from the University of Atatürk, Turkey, in 2004 and the master and Ph.D. degrees in agricultural engineering from the Agriculture Faculty of Atatürk University, Erzurum, Turkey, in 2007 and 2011, respectively. She was an Associate Professor in 2013. Her current research interests include fish processing, aquatic toxicology, and molecular biology.

# Effects of Chlorpyrifos on G6PD of Rainbow Trout (*Oncorhynchus mykiss*)'s Tissue

Muhammed Atamanalp<sup>1</sup>, Veysel Parlak<sup>1</sup>, Gonca Alak<sup>1</sup>, Esat Mahmut Kocaman<sup>1</sup>

---

## Abstract

Chlorpyrifos (CPF) is one of the most widely used type of insecticide and it causes toxic effects in non-target aquatic organisms, especially fish. In this study the responses of mature rainbow trout *Oncorhynchus mykiss* exposed to 2 µg/l CPF concentrations for periods of 21 days. The following oxidative stress marker Glucose-6- phosphate dehydrogenase (G6PD) was measured in the samples taken from gill, liver and kidney. G6PD decreased in all tissue ( $p < 0.01$ ). These results indicate a close relationship between G6PD inhibition in rainbow trout exposed to CPF at environmentally realistic concentrations.

**Key Words:** Oxidative stress responses, rainbow trout, pesticide, fish, G6PD

---

## 1. INTRODUCTION

Pesticide pollution is a threat to the aquatic ecosystems, which has drawn attention towards ecotoxicological research. Contamination from pesticides is now widespread in streams and ground water throughout agricultural and urban areas [1,2]. Chlorpyrifos (CPF, (O,O-dyethyl O-3,5,6-trichloro-2-pyridyl phosphorothioate)), which contains a phosphorothiol functional moiety, has been widely used in agricultural practices to increase crop yields throughout world [3-4,1]. (Recently, there are fishes studies that show that CPF could cause oxidative stress, biochemical and histopathological changes in the immune organ of fish [5-7,3,4,8, 2]. Aquatic organisms especially fish can also serve as a sensitive bioindicator of environmental contaminants, including the presence of xenobiotics, toxins, and other alterations in natural water quality parameters [9]. The present study investigates the effects of chlorpyrifos exposures on G6PD antioxidan enzyme activity in mature trout.

## 2. MATERIALS AND METHODS

### 2.1. Fish Maintenance And Experimental Design

Rainbow trout (*O. mykiss*) and (average weight  $200 \pm 15$  g) were obtained from Ataturk University, Faculty of Fisheries, Inland Water Fish Application and Research Center and the study was conducted at Fisheries Application and Research Center's Toxicology Experiment Unit. The experiment was conducted for 21 days in fiberglass tanks with 44 trouts (*O. mykiss*). The water has been distributed to the tanks with a minimum flow of 0.5 l/min per kg of fish. Water temperature  $11.5 \pm 2.5$  °C, dissolved oxygen 9,1 mg/l and pH 7.4 oxygen has been measured during the study. 11 fish have been distributed per tank for a total of 4 tanks. 2 of the tanks have been set aside as the control group and the other 2 tanks have been defined as the treatment groups.

Chlorpyrifos was obtained from a distributor company (Turkey) as commercial formulation. Chlorpyrifos's stock solution were solubilized in reagent grade acetone. CPF concentrations were calculated for rainbow trout of chlorpyrifos was 2 µg/l (FAO). As per the trial procedure for defined volume retrials, the concentrations have been reapplied every 12 hours in order to recreate the dose. Following experiment period, control and all exposed fish were chosen from each tank randomly and were sampled at the end of the trail period.

### 2.2. Determination Of Antioxidan Enzyme Activities

Fish were immediately sacrificed by cervical dislocation and dissected promptly. Liver, gill and kidney tissues were snap frozen in liquid nitrogen. All samples were then stored at -80°C until analyses [10]. Extracts from each tissue (gill, liver and kidney) were prepared from each individual in according to Alak et al. [11] with a little modification. The samples were homogenized by  $\text{KH}_2\text{PO}_4$  (30mM, pH=7.3) buffer. And then homogenates were centrifuged at 13000 rpm, 1 hours at 4 °C. These supernatants were used for the determination of the enzymatic activities. All results were referred to the protein content in the samples. G6PD; activity was assayed according to Beutler [12]. This activity measurement was performed at 340 nm spectrophotometrically. The assay system contained 1 M Tris-HCl, 5 mM EDTA buffer (pH 8.0), 0.1 M  $\text{MgCl}_2$ , 2 mM NADP<sup>+</sup>, 6 mM G6P, distilled water and tissue homogenate

### 2.3. Statistical Analysis

---

<sup>1</sup> Corresponding author: Department of Aquaculture, Faculty of Fisheries, Ataturk University, TR-25240 Erzurum, Turkey.  
[galak@atauni.edu.tr](mailto:galak@atauni.edu.tr)



The SPSS 20.0 software was used to perform all analyses. The data are expressed as the mean  $\pm$  SD. Significant difference was acknowledged when  $p \leq 0.05$ .

### 3. RESULTS AND DISCUSSION

Since water environments are the primary receiving environments for domestic, industrial and agricultural waste, as a result aquatic organisms are directly under the influence of pollutants. Organic and inorganic pollutants will accumulate in the tissues and organs of fish and above a certain threshold they will result in mortality, stress and reduction in fertility. Furthermore, they can cause changes in the metabolic and physiological events. Hence, it is essential to determine the oxidative stress in water organisms (which are under the influence of pollutants), as it reflects the level of pollution in the environment [13]. The effect of CPF oxidative stress response of rainbow trout on gill, liver and kidney tissues were showed by in vivo studies. CPF exposure to caused significant change in the all tissues G6PD enzyme activities of rainbow trout (Table 1)

Table 1. The effect of different concentrations of CPF on gill, liver and kidney G6PD enzyme activity of rainbow trout (*O. mykiss*)

Group	Tissue	Mean $\pm$ SD
Control <sup>A</sup>	Gill	0.47 $\pm$ 0.02 <sup>b</sup>
	Liver	0.27 $\pm$ 0.01 <sup>c</sup>
	Kidney	0.48 $\pm$ 0.04 <sup>a</sup>
Treatment <sup>B</sup>	Gill	0.27 $\pm$ 0.02 <sup>b</sup>
	Liver	0.20 $\pm$ 0.01 <sup>c</sup>
	Kidney	0.42 $\pm$ 0.01 <sup>a</sup>

Liver, placed at an important place between the general circulatory system and digestive tract, helps the foodstuffs to be properly metabolised and is provided with a group of mechanism that disposes potential harmful substances and detoxifies them. This organ also includes highly specific and selective transport mechanisms for necessary foodstuffs, and these foodstuffs not only provide the necessary energy but also supply physiologically important substances for the systemic necessities of the organism [14].

All organisms have systems for protecting themselves against the damaging effects of biotic and abiotic ROS [15]. In the present study, G6PD activities in the gill, liver and kidney altered after CPF exposure (Figure 1)( $p < 0.01$ ).

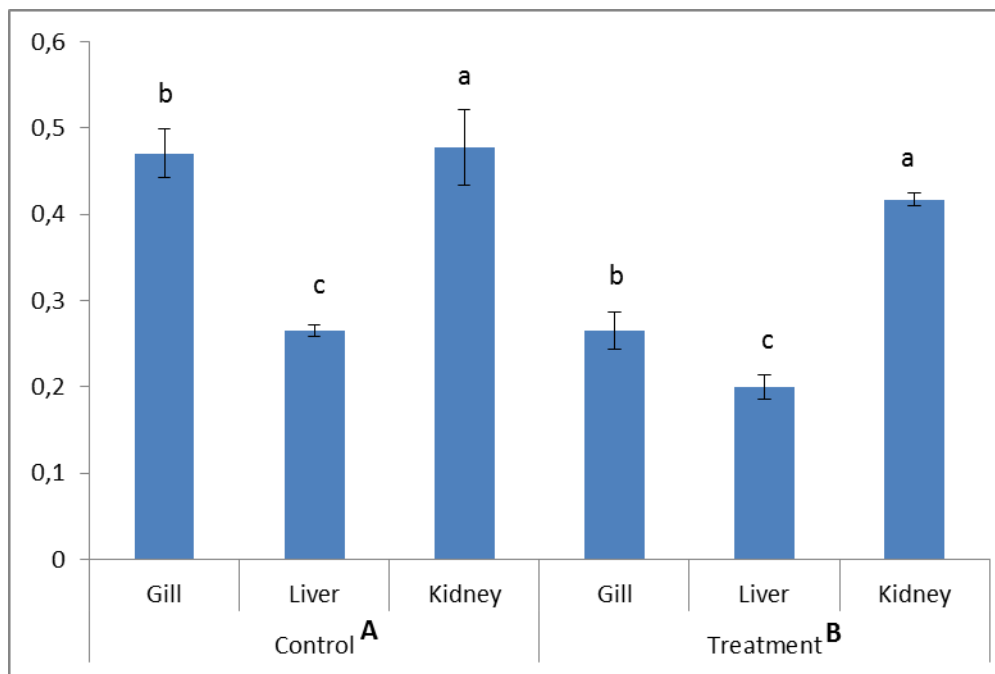

Fig.1. Lowercase superscripts (a, b) indicate significant differences among different tissue within each experimental treatment group, whereas superscripts in uppercase show significant differences among dosage. Each value is the mean  $\pm$  S.D. of eleven individual observations. For treatment groups: Control (no treatment), 2  $\mu$ g/l, \*\*  $p < 0.01$  G6PD enzyme is EU mg protein<sup>-1</sup>

The data provide evidence for induction of oxidative stress on CPF exposure. There are many studies relationships with pesticide and G6PD activities in different species in the literature [16-21]. But, there is no study with chlorpyrifos and G6PD activity of trout. In present study, a decrease in G6PD activity was observed in all tissues after 2  $\mu$ g/l concentration of

chlorpyrifos. In these changes, O<sub>2</sub> production and inhibition effects on the enzyme activity of some substance such as pesticide may be effected [22]. The data of this study will help in understanding the biochemical basis of response of trouts exposed to pesticides. More investigations must be performed to better understand the specific oxidative stress response of trouts of CPF toxicity.

## ACKNOWLEDGMENTS

This study was supported Ataturk University, Turkey.

## REFERENCES

- [1] V.C. Renick, T.W. Anderson, S.G. Morgan and G.N. Cherr, "Interactive effects of pesticide exposure and habitat structure on behavior and predation of a marine larval fish", *Ecotoxicology*, vol.24, 391–400, 2015.
- [2] H. Xing, T., LiuZhang, Z. Wang, and S. Xu, "Acute and subchronic toxic effects of atrazine and chlorpyrifos on common carp (*Cyprinus carpio L.*)", *Immunotoxicity assessments*, vol. 45(2), 327–333, 2015.
- [3] K.J.G. Díaz-Resendiz, and M.I. Girón-Pérez, "Effect of chlorpyrifos on the immune response of Nile tilapia (*Oreochromis niloticus*)", *Revista Bio Ciencias*, vol.3(1), 59-64, 2014.
- [4] H.J. Jeon, Y. Lee, H. Mo, M. Kim, M.I. Al-Wabel, Y. Kim, K. Cho, T. Kim, Y.S. Ok, and S. Lee, "Chlorpyrifos-induced biomarkers in Japanese medaka (*Oryzias latipes*)", *Environ Sci Pollut Res*, DOI 10.1007/s11356-015-4598-0, 2015.
- [5] M.E. Yonar, S.M. Yonar, M.Ş. Ural, S. Silici, and M. Düşükcan, "Protective role of propolis in chlorpyrifos-induced changes in the haematological parameters and the oxidative/antioxidative status of *Cyprinus carpio carpio*", *Food and Chemical Toxicology*, vol.50, 2703–2708, 2012.
- [6] H. Xing, H. Wu, G. Sun, Z. Zhang, S. Xu, and S. Li, "Alterations in activity and mRNA expression of acetylcholinesterase in the liver, kidney and gill of common carp exposed to atrazine and chlorpyrifos", *Environ Toxicol Pharmacol*, vol.35,47–54, 2013.
- [7] S. Wang, S. Zhang, L.C. Liou, Z. Zhang, G.A. Caldwell, K.A. Caldwell, and S.N. Witt, "Phosphatidylethanolamine deficiency disrupts  $\alpha$ -synuclein homeostasis in yeast and worm models of Parkinson disease", *Proc Natl Acad Sci U S A*. doi:10.1073/pnas.1411694111, 2014.
- [8] A. Topal, M. Şişecioglu, M. Atamanalp, A. Işik, and B. Yılmaz, "The in vitro and in vivo effects of chlorpyrifos on acetylcholinesterase activity of rainbow trout brain", *Journal of Applied Animal Research*, <http://dx.doi.org/10.1080/09712119.2015.1031776>, 2015.
- [9] R. Oost, J. Beyer, and N.P.E. Vermeulen, "Fish bioaccumulation and biomarkers in environmental risk assessment: a review", *Environmental Toxicology and Pharmacology*, vol.13, 57-149, 2003.
- [10] E.S. Botté, D.R. Jerry, S. Codi King, C. Smith-Keune, and A.P. Negri, 2012. "Effects of chlorpyrifos on cholinesterase activity and stress markers in the tropical reef fish *Acanthochromis polyacanthus*", *Marine Pollution Bulletin*, vol.65, 384–393
- [11] G. Alak, M. Atamanalp, A. Topal, H. Arslan, E. Oruç, and S. Altun, "Histopathological and biochemical effect of humic acid against cadmium toxicity in brown trout gills and muscle", *Turkish Journal of Fisheries and Aquatic Sciences*, 315-320, 2013.
- [12] E. Beutler, *Red Cell Metabolism: A Manual of Biochemical Methods*, 2nd ed., Grune and Starton, New York : 1984.
- [13] M.E. Özslan, "Determination of sera glucose, electrolite, hematocrite and some blood parameters of *Clarias gariepinus* from drainage channels of lower seyhan plains",. Dissertation, University of Cukurova, 2008.
- [14] M. Yılmaz, "The effects of some pesticides on acetylcholinesterase, antioxidant enzyme activities and the malondialdehyde level in tissues of rats",. Dissertation, University of Çukurova, 2010.
- [15] H. Xing, X. Wang, G. Sun, X. Gao, and S. Xu, "Effects of atrazine and chlorpyrifos on activity and transcription of glutathione S-transferase in common carp (*Cyprinus carpio L.*)", *Environ Toxicol Pharmacol*, vol.33, 233–244, 2012.
- [16] M. Şentürk, S.B. Ceyhun, O. Erdoğan, and İ.Ö. Küfrevioğlu, "In vitro and in vivo effects of some pesticides on glucose-6-phosphate dehydrogenase enzyme activity from rainbow trout (*Oncorhynchus mykiss*) erythrocytes", *Pesticide Biochem. and Physiol.*, vol.95, 95-99, 2009.
- [17] S. Woo, S. Yuma, D. Kimb, and H. Park, "Transcripts level responses in a marine medaka (*Oryzias javanicus*) exposed to organophosphorus pesticide", *Comparative Biochemistry and Physiology Part C: Toxicology & Pharmacology*, vol.149 (3), 427–432, 2009.
- [18] M.Ş. Yıldız, Y.S. Arnyürek, and K. Aksoy, "Detection of mediterranean mutation in the glucose-6-phosphate dehydrogenase gene with microarray technique", *Turkish Journal of Biochemistry*, vol.35 (1), 63-66, 2010.
- [19] E. Hopa, S. Sinan, and Y. Turan, "The inhibitory effects of some pesticides on human erythrocyte glucose-6-phosphate dehydrogenase activity (in vitro)", *Fresenius Environmental Bulletin*, vol.20(5a), 1314-1319, 2010.
- [20] M. Guler, M.R. Kivanc, V. Turkoglu, Z. Basi, and H. Kivrak, "In vitro determination of 6PGD enzyme activity purified from Lake Van fish (*Chalcalburnus tarichii* Pallas, 1811) liver exposed to pesticides", *Bull. Environ. Contam. Toxicol.*, vol.91 (5), 560–564, 2013.
- [21] E. Hopa, S. Sinan, and E. Sevindik, "The effects of deltamethrin and diazinon chemicals on human erythrocyte glucose-6-phosphate dehydrogenase enzyme", *Journal of Applied Biological Sciences*, vol. 9 (1), 31-35, 2015.
- [22] Topal, M. Atamanalp, E. Oruç, M. Kırıcı, and E.M. Kocaman, "Apoptotic effects and glucose-6-phosphate dehydrogenase responses in liver and gill tissues of rainbow trout treated with chlorpyrifos", *Tissue and Cel.*, vol.46(6), 490–496, 2014.

## Biography

Muhammed Atamanalp was born in Erzurum, Turkey, in 1971. He received the agricultural engineering degree in Agriculture Faculty from the University of Atatürk, Turkey, in 1993 and the master and Ph.D. degrees in agricultural engineering from the Fisheries Department of Atatürk University, Erzurum, Turkey, in 1996 and 2000, respectively. In 1993, he joined the Department of Aquaculture, University of Atatürk, as a Lecturer, and in 2001 became an Assistant Professor. In 2004 an Associate Professor, a Professor in 2009 and dean of the Fisheries Faculty of Atatürk University 2010. His current research interests include fish breeding, aquatic toxicology, fisheries and environment. Dr. Atamanalp is a member of the World Aquaculture Society.

# The Effect of Afforestation Site Conditions in Malatya Region on Growth Performance of Taurus Cedar (*Cedrus libani* A. Rich.)

Atilla Atik<sup>1</sup>

---

## Abstract

Tree plantation and/or afforestation works are a combination of activities requiring intensive labor and cost. The results of these activities can be explained by the effects of several factors with varying impact across time and space. Some of these factors are abiotic, such as geographic, edaphic and climatic characteristics, while others are biotic, such as decomposer characteristics of activity of microorganisms and fungi.

The present study was conducted to determine the effect of site conditions on the growth performance of cedar seedlings (*Cedrus libani*) planted on a tree plantation in Malatya province, Eastern Turkey.

In total, 93 experimental areas were chosen systematically at the end of second vegetation period in the plantation area. Then, various parameters were measured in the experimental areas. A factor analysis was carried out to determine the most critical factors influencing the percent of height and root collar diameter. These parameters were found to be most affected by Organic Substance Rate, Inorganic Substance Rate (I), Soil Texture Type, Lime (CaCO<sub>3</sub>) Content, Elevation, and Inorganic Substance Rate (II).

**Keywords:** Afforestation, Growth, *Cedrus libani*, Malatya.

---

## 1. INTRODUCTION

The cedar tree has played an important role in social and cultural life in Anatolia and surrounding areas. It is one of the important genera of Pinaceae family, and its four distinct subspecies are prevalent in North Africa, Southern Anatolia, Lebanon, Cyprus and Himalayas. These subspecies are *Cedrus libani* A. Rich., *Cedrus deodora* Loud, *Cedrus brevifolia* Hen. and *Cedrus atlantica* Manetti. Of these species, only *Cedrus libani* grows naturally in Turkey, and it is known as Taurus Lebanon cedar [1-3].

Due to its high adaptive capability and economic value of its wood, *C. libani* is one of the most common forest tree in plantations in several countries, such as Turkey[4], Italy [5,6], Iran [7] and Bulgaria[8].

Forest establishment activities are a group of time consuming, costly and attention-heavy activities including preparing land, choosing appropriate species for growth conditions the area, planting and maintaining seedling after planting. It is only possible for the planted seedlings to be successful by adapting different environmental conditions with a variety of stress factors. The basis of the adaptation capacity of a living organism is its resistance to the impact of environmental stress factors and the survival of structural integrity. There is a strong and positive relationship between the resistance of plants to biotic and abiotic stress factors and the biochemical and physiological plant processes that make up the fundamentals of plant metabolism, such as photosynthesis, respiration, and transpiration. When this relationship is broken, the growth rate of plants may slow, the plant may weaken and it could die. Therefore, it is extremely important to choose appropriate tree species for planting on the selected land.

Present study aims to determine the potential effects of geographic and edaphic abiotic factors on the growth and adaptation capability of *Cedrus libani*. To achieve this objective, *Cedrus libani* plantation sites were chosen as the study areas. The plantations were located on the right coast of Karakaya Dam Watershed in Malatya province, east of Turkey.

## 2. MATERIALS AND METHODS

Data used in the study was obtained from *Cedrus libani* plantation sites in the project area, which was the right coast of Karakaya Dam Watershed in Malatya province, east of Turkey (Figure 1).

---

<sup>1</sup>Corresponding Author: atikatilla@hotmail.com

Inonu University Faculty of Fine Arts and Design Department of Landscape Architecture, 44280, Malatya-Turkey.

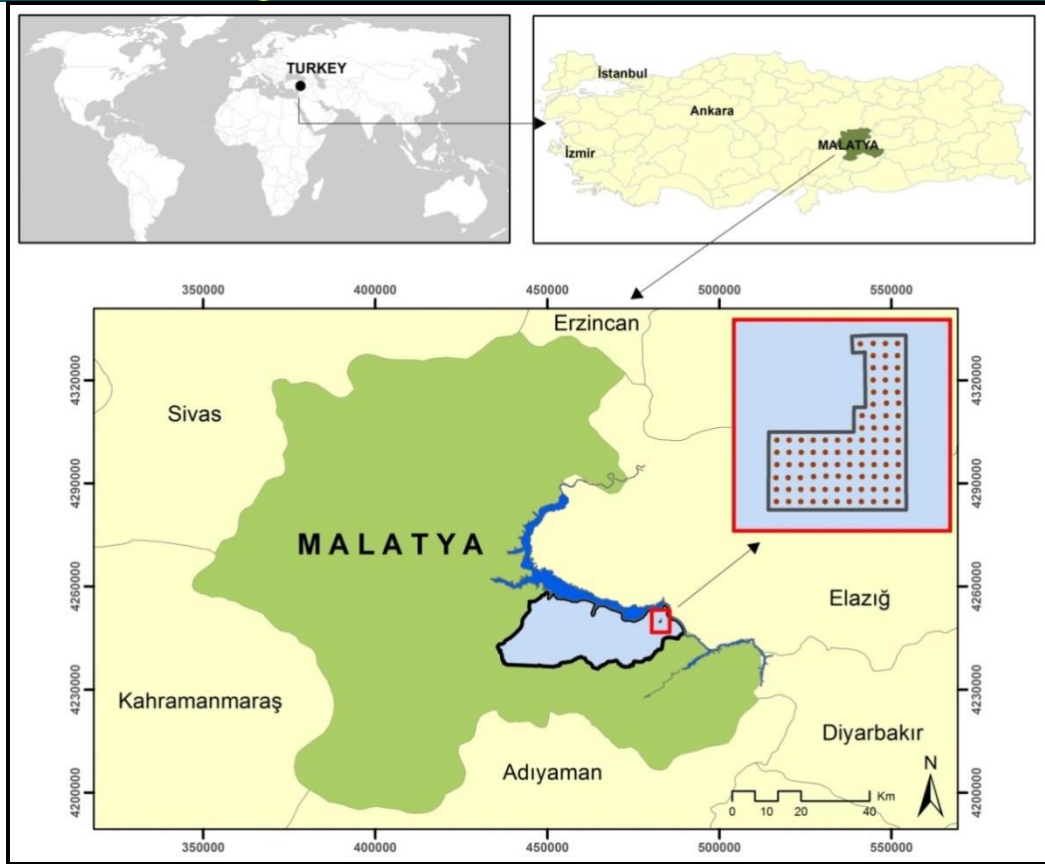

Figure 1. Map of the study area.

A block of 93 ha pure *C. libani* plantation area was transferred into GIS on a 1/25000 scale map of the coastal plantation project area of Karakaya Dam Watershed. One-hectare experimental sites including the border of the plantation area were systematically marked on a map leaving a 100 – m gaps between each site. In total, 93 experimental sites in the study area were selected, and their coordinates were recorded.

In each experimental plot, seedling height and root collar diameter were measured, which are considered to be important morphological parameters by several authors [9-16].

Geographic data was obtained from the field measurements by processing with GIS. Edaphic data was measured at experimental sites by collecting and analyzing soil samples from 0 to 30 cm depth. Quantities of sand, dust and clay were determined through physical soil analyses, while pH value was calculated through the NaOH method. Quantities of organic materials were determined by burning samples at 790 °C for two hours according to a burning method, while inorganic compound rate was calculated using the XRF method.

Multidimensional statistical analysis was conducted to determine the common effect of several different but related variables. A total of 18 geographic and edaphic variables were calculated, which were thought to affect seedling development. Parameters that affected seedling height and root collar diameter were determined through principal component analysis.

Factor analyses [17] were used to evaluate all variables simultaneously and to determine the most important factors affecting seedling height, root collar diameter and seedling vitality percentage. For factor analyses, a data matrix with  $N \times n$  ( $93 \times 18$ ) dimensions was input into a principal component model using the Varimax criterion and Kaiser Normalization [18].

### 3. RESULT AND DISCUSSION

At the first stage of data analysis, principal component analysis was used to divide variables into groups to determine the most important factors affecting seedling height and root collar diameter. Among 18 variables, 6 components or factors whose variance was greater than 1 were extracted (the Kaiser Criterion). Thus, 18 variables were reduced to 6 factors with 26% data loss. According to the results of the principal component analysis with rotation, 74% of total variance among 18 variables was explained by these 6 factors.

The most important factors affecting seedling growth and the variables representing them are shown in Table I. These factors explain 74.095% of seedling growth.

Table I. Factors affecting on seedling growth.

Factor No	Name of Factor	Weight of Factor (%)	Indicator Variable of Factor	Weight of Variable
1	Organic Substance Rate	19.366	ORG	-0.813
2	Inorganic Substance Rate (I)	13.867	Al <sub>2</sub> O <sub>3</sub>	0.929
3	Soil Texture Type	12.957	SAND	0.936
4	Lime (CaCO <sub>3</sub> ) Contents	10.788	CaCO <sub>3</sub>	0.911
5	Elevation	8.954	ELV	-0.774
6	Inorganic Substance Rate (II)	8.165	Fe <sub>2</sub> O <sub>3</sub>	0.889
<b>Total</b>		<b>74.095</b>		

The effects of the most important six factors (independent variables) determined as the result of the factor analysis *Cedrus libani* height and root collar diameter development (dependent variables) was calculated using multiple regression analyses (Tables II-III).

Table II. Results of multiple regression analyses explaining variation in seedling height growth.

Independent Variables	Coefficients	Std. Error	Sig.	R <sup>2</sup>	F-statistic
(Constant)	34.891	13.716	0.013		
Organic Substance Rate	5.702***	0.802	0.000		
Inorganic Substance Rate (I)	-0.064	0.241	0.793		
Soil Texture Type	0.024	0.149	0.873	0.524	15.756*
Lime (CaCO <sub>3</sub> ) Contents	-0.534	0.440	0.228		
Elevation	-0.024***	0.005	0.000		
Inorganic Substance Rate (II)	0.649	0.340	0.059		

\*Significant at the 0.05 level ( $p < 0.001$ ).

According to Table II, where the dependent variable seedling height growth, 52.4% ( $R^2=0.524$ ) of seedling height growth is explained by these 6 factors. The most important of these factors are organic content of soil and elevation, which have positive and negative effects, respectively on height growth of *Cedrus libani* seedlings at confidence interval of 99%. According to these results, a multiple regression model of seedling height growth and 6 factors can be written as follows:

$$Y(\text{SEEDLING HEIGHT GROWTH}) = 34.891 + 5.702X(\text{ORGANIC SUBSTANCE RATE}) - 0.064X(\text{INORGANIC SUBSTANCE RATE (I)}) + 0.024X(\text{SOIL TEXTURE TYPE}) - 0.534X(\text{LIME (CaCO}_3\text{ CONTENTS)}) - 0.024X(\text{ELEVATION}) + 0.649X(\text{INORGANIC SUBSTANCE RATE (II)})$$

Table III. Results of multiple regression analyses explaining variation in seedling root collar diameter growth.

Independent Variables	Coefficients	Std. Error	Sig.	R <sup>2</sup>	F-statistic
(Constant)	13.020	5.091	0.012		
Organic Substance Rate	2.116***	0.298	0.000		
Inorganic Substance Rate (I)	-0.026	0.090	0.769		
Soil Texture Type	0.008	0.055	0.885	0.523	15.717*
Lime (CaCO <sub>3</sub> ) Contents	-0.200	0.163	0.224		
Elevation	-0.009***	0.002	0.000		
Inorganic Substance Rate (II)	0.241	0.126	0.060		

\*Significant at the 0.05 level ( $p < 0.001$ ).

According to Table III, where the dependent variable is seedling root collar diameter development, 52.3% ( $R^2=0.523$ ) of seedling root collar diameter growth is explained by these 6 factors. Most important of these factors are organic content of soil and elevation, which have positive and negative effects, respectively, on seedling root collar diameter development of *C. libani* seedlings at confidence interval of 99%. According to these results, a multiple regression model of root collar diameter development with 6 factors can be written as follows:

$$Y(\text{SEEDLING ROOT COLLAR DIAMETER GROWTH}) = 13.020 + 2.116X(\text{ORGANIC SUBSTANCE RATE}) - 0.026X(\text{INORGANIC SUBSTANCE RATE (I)}) + 0.008X(\text{SOIL TEXTURE TYPE}) - 0.200X(\text{LIME (CaCO}_3\text{ CONTENTS)}) - 0.009X(\text{ELEVATION}) + 0.241X(\text{INORGANIC SUBSTANCE RATE (II)})$$

#### 4. CONCLUSIONS

In the scope of the present study, factors impacting the success of *Cedrus libani* plantation and the magnitude of their effect were assessed by studying a project implemented in the Karakaya Dam Watershed, Malatya Province, eastern part of Turkey. The findings of the study showed that the most important factors affecting height and root collar diameter of seedlings are elevation and organic content of soil.

There was a very strong relationship between height and root collar diameter development of *Cedrus libani* seedlings in experimental areas and organic content of soil (positive) and elevation (negative).

Although the results of the present study provide information about the factors important locally on the adaptation and development of *C. libani* seedlings, they cannot be applied to make a definitive statement at the linear and comprehensive levels. To obtain more general results, similar studies and evaluations need to be carried out in the plantation areas with different geographic, edaphic and climatic characteristics, using seedlings of different origins and ages and different land preparation, plantation and maintenance methods.

Measurement and evaluation of tree plantations comes with the cost and labor of long term monitoring and observation. To make a concrete assertion on the success after plantation, a longer time period than the average human life is required. Thus, the ultimate success evaluation and conclusion may not be possible because the results of the study represent only two vegetation periods. However, ultimate success, the factors affecting this success, and the temporal effects of abiotic ecological factors on the success could be determined through a long-term field monitoring study.

## ACKNOWLEDGEMENTS

This study was compiled from article which published in *Energy&Environment*[2015, 26(3):369-389] whose presented by Authors (Atilla Atik and Fűrüzan Aslan).

## REFERENCES

- [1] M.Seamaan andR. Haber, "In situ conservation of *Cedrus libani* in Lebanon,"*Acta Hort (ISHS)*, 615: 415-417, 2003.
- [2] M.Boydak andM.Çalikođlu,"Biology and silviculture of Lebanon cedar (*Cedrus libani* A. Rich.)," OGEM-VAK, Ankara, p. 228 (in Turkish), 2008.
- [3] A.Kavgacı, S.Başaran andMA.Başaran,"Cedar forest communities in Western Antalya (Taurus Mountains, Turkey),"*Plant Biosystems* 144(2): 271-287, 2010.
- [4] M.Boydak,"Regeneration of Lebanon cedar (*Cedrus libani* A. Rich.) on karstic lands in Turkey,"*Forest Ecology and Management*, 178(2003): 231-243, 2003.
- [5] E. Fusaro,"Characteristics and distribution of cedar afforestation in Italy,"*In: Proceedings of the International Cedar Symposium (Muhtelif Yayınlar No. 59)*. Antalya: Ormancılık Araştırma Enstitüsü Yayınları. pp. 273-285,1990.
- [6] R. Morandini and R. Mercurio,"Atlas cedar (*Cedrus atlantica* Man.) in Italy,"*In: Proceeding of the International Cedar Symposium (Muhtelif Yayınlar No. 59)*. Antalya: Ormancılık Araştırma Enstitüsü Yayınları. pp. 302-307,1990.
- [7] F. Assadollahi andMA.Hedayeti. "Cedrus plantation experiments in Iran,"*In: Proceedings of the International Cedar Symposium (Muhtelif Yayınlar No. 59)*. Antalya: Ormancılık Araştırma Enstitüsü Yayınları. pp. 266-272, 1990.
- [8] TS.Tsanov, Y. Naidenov andK.Kalmoukov,"Le Cedre (*Cedrus*) en Bulgarie etat et perspectives,"*In: Proceedings of the International Cedar Symposium (Muhtelif Yayınlar No. 59)*. Antalya: Ormancılık Araştırma Enstitüsü Yayınları. pp. 308-324,1990.
- [9] Y.Şimşek,"Problems of quality seedling usage in afforestation,"*Journal of Forestry Research Institute*, 65: 5-29,1987.
- [10] H. Dirik,"Relations between some important seedling characteristic and success of planting in Calabrian pine (*Pinus brutia* Ten.)," Ph. D. thesis, Department of Silviculture, Institute of Science, İstanbul University, İstanbul pp. 10-24,1991.
- [11] S.Ürgenç, CÜ. Alptekin CÜ and H. Dirik,"Produce and quality problems in our forest nursery." *I. Seedling Symposium in Turkey*. Ankara pp. 325-331, 1991.
- [12] Ö.Görücü andS.Çađlar,"Root renovating (regeneration) on deciduous seedlings after replaced,"*Journal of Poplar and Fast Growing Exotic Forest Trees Research Institute*, 210(23): 1-1, 1996.
- [13] EL.Graham, MJ.Graham andWL.Wilcox,"Plant biology," Ankara: Palme Publication. p. 427, 2004.
- [14] B.Avanođlu, S.Ayan,N.Demirciođlu, A.Sivaciođlu,"Evaluation of two years old seedlings of the Anatolian black pine (*Pinus nigra* Arnold. subsp. *pallasiana* (Lamb.) Holmboe.) raised in Kastamonu-Taskopru Forest Nursery as to TSI quality classification,"*Journal of Engineering and Natural Sciences*, 5: 73-83, 2005.
- [15] A. Atik,"Effect of different concentrations of effective microorganisms (Baikal EM1) on the root collar diameter and height growth in the seedlings of Anatolian black pine [*Pinus nigra* Arnold. subsp. *pallasiana* Lamb. (Holmboe)],"*International Journal of Food, Agriculture & Environment*, 11(2): 1300-1304, 2013a.
- [16] A.Atik,"Effects of planting density and treatment with vermicompost on the morphological characteristics of oriental beech (*Fagus orientalis* Lipsky.),"*Compost Science & Utilization*, 21(2): 87-98, 2013b.
- [17] HH.Harman,"Modern factor analysis," 2<sup>nd</sup> ed. University of Chicago Press, Chicago, Illinois p. 474, 1967.
- [18] JF.Hair, RE.Anderson, RL.Tatham and WC. Black, "Multivariate data analysis with readings," 3<sup>rd</sup> edn. Macmillan, New York, 1992.

## Modified SPWM to reduce switching losses in Standby UPS Systems for Sustainable Energy

*Mustafa Inci<sup>1</sup>, Mehmet Buyuk<sup>1</sup>, Mehmet Tumay<sup>1</sup>*

### Abstract

The sustainable energy transmission plays an important role for all energy generation methods such as wind energy, solar cell and hydroelectric stations. The environmental effects in electrical energy systems create serious voltage variations. The variations in voltage magnitude of electrical grids affect the operations of electrical devices and lead to losses and malfunction with negative effects of the devices. Electronic-based devices called as "uninterruptible power supplies (UPS)" are used to fulfill stability operation of electrical appliances without being the affected by the voltage variations. The most well-known and simple system topology is Standby UPS used for sustainable energy operation. In Standby UPS, Sinusoidal PWM (SPWM) is the most commonly used technique to generate switching signals. However, SPWM based UPS causes high switching losses due to continuous operation, and this condition influences the battery life and discharging time. In order to reduce the switching losses in these systems, modified SPWM is performed in UPS. In this study, the operation principle and analysis of modified SPWM based UPS are also introduced by modeling of simulation study. The proposed system is designed according to convenient values such as 220 Vrms/50 Hz and 1 kVA. Besides, the performance results for different case studies are analyzed by using PSCAD/EMDT 4.2.1.

**Keywords:** Modified PWM, Standby UPS, Sustainable energy, Voltage variations

### 1. INTRODUCTION

Power quality problems are defined as deviations in current and voltage which cause economical loss and malfunctions of equipments in electrical systems. The most wide spread power quality problems in electrical grids are voltage interruptions and voltage sags. Voltage interruptions are defined as large decrease in voltage magnitude or completely loss of electricity [1-3]. Voltage sags are the reduction of voltage magnitude between 0.1 pu and 0.9 pu. The duration of voltage disturbances are described from half period to 1 minute which expressed in IEEE 519-1992 standards [4]. The voltage waveforms of voltage sags and interruptions are presented in Figure 1. In order to prevent the negative effects of these voltage variations occurred in electrical grids, custom power devices called as Uninterruptible Power Supplies (UPS) are used in domestic applications [5-8]. UPS provides an alternative energy to maintain voltage stability for smooth operation of electricity applications during voltage disturbances. With the technological developments, electrical demand continuously increases. Especially, electrical demand is one of the most important requirements in hospitals, airports, schools and industrial areas.

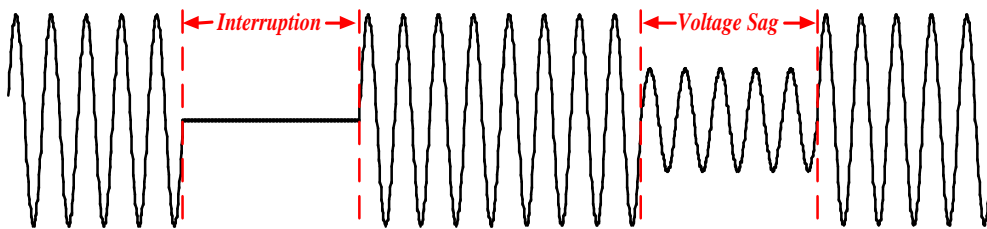

Figure 1. The voltage waveforms of voltage interruptions and sags

The utilization of UPS is a requirement which provides the continuous and accurately operation of all sensitive devices. Usually, UPSs connected to computers in homes and schools are called as Standby UPS. Standby UPS is a preferable device which has advantages such as simple structure, low-cost and no-noise operation [9]. At the same time, these systems have high switching losses and low battery life for applications. Sinusoidal PWM (SPWM) is the most common technique to generate

<sup>1</sup>Corresponding author: Çukurova University, Department of Electrical and Electronics Engineering, 01330, Balcalı, Sarıçam/Adana, Turkey. [minci@cu.edu.tr](mailto:minci@cu.edu.tr)

switching signals in these systems. But, this method cause high switching losses due to continuous switching process. In order to reduce losses and increase battery life, modified SPWM is implemented in Standby UPS.

In this paper, the operation and working principles of a Standby UPS are explained in detailed. Then, modified SPWM is performed to reduce switching losses in inverter of Standby UPS topology. The performance results of proposed system is modeled and simulated by using PSCAD/EMDT program.

## 2. STANDBY (OFFLINE) UPS

### 2.1. Structure

Standby UPS is also known as “Off-line UPS”. Standby UPS is preferred in low power applications such as computers. The working principle of this UPS is introduced in Figure 2. In electrical systems, ac voltage is transmitted in grids. Therefore, UPS is designed to generate ac voltage at its outputs during voltage interruptions and sags.

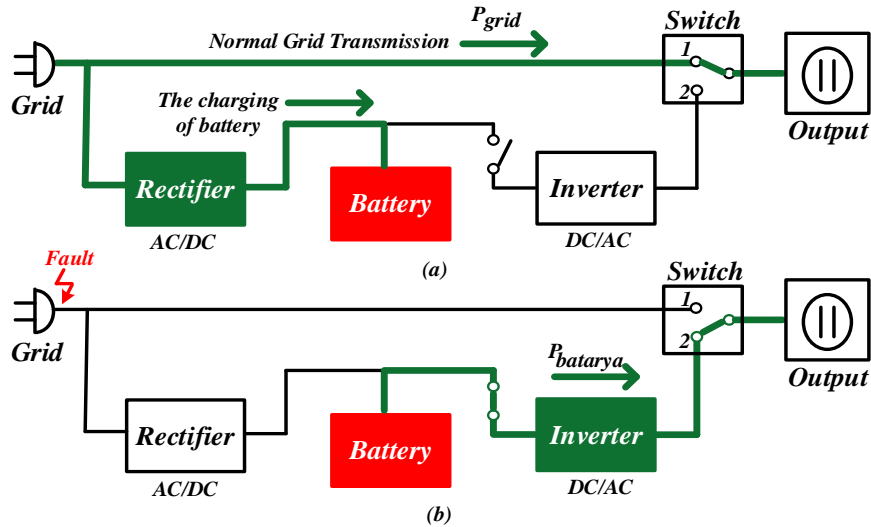

Figure 2. Standby (Off-line) UPS

The main components of a Standby UPS are charging circuit, battery and inverter. Rectifier is also known as charging circuit, and it converts AC voltage to DC voltage to charge battery. In steady-state conditions, the supplying of dc voltage in inputs of battery is to keep battery voltage at full-value (Figure 2.a). During fault conditions, battery is performed to keep voltage magnitude constant at output. Therefore, inverter is switched to generate ac voltage by using dc voltage of battery (Figure 2.b). In final process, the generated voltages are filtered and supplied to sensitive loads. LC filter is used to eliminate high frequency voltage distortions due to switching in inverter.

### 2.2. Working Principle

According to the working principles of Standby UPS, grid is directly connected to sensitive load during normal situation, and there is no electrical interconnection between UPS and load. In normal situation, a small current fed from battery is used to charge the battery and keep the battery at full level. The grid side voltage is defined in (1):

$$V_{grid} = V_m \sin(\omega t) \tag{1}$$

Where,  $V_m$  is voltage magnitude,  $\omega$  is angular frequency and  $t$  is time.

The output voltage of charging circuit is equal to the magnitude of voltage:

$$V_{battery} = V_m \tag{2}$$

### 2.3. Generation of Switching Signals

In electrical interruptions or voltage sag conditions, the switch position changes to keep output side voltage constant, and output power is supplied from UPS. Sensitive loads are not affected negatively from transition of switch because of the speed of switching is lower than a quarter period (5 ms). Power flow conditions are expressed in (3-4) for switch conditions.

$$\text{Switch Position : 1} \quad P_{load} = P_{grid} \tag{3}$$



$$\text{Switch Position : 2} \quad P_{load} = P_{battery} \quad (4)$$

UPS becomes active when switch condition changes from position-1 to position-2 in voltage sag/interruptions. For active condition, inverter generates ac voltage by using energy storage in battery at output-side load. The output voltage of inverter is defined by using Fourier Series [10]:

$$V_{inverter} = \sum_{n=1,3,5}^{\infty} \frac{4V_{battery}}{n\pi} \sin(n\omega t) = \sum_{n=1,3,5}^{\infty} \frac{4V_m}{n\pi} \sin(n\omega t) \quad (5)$$

Where,  $V_m$  is the amplitude of grid side voltage,  $n$  is the order of voltage components,  $\omega = 2\pi f$  is unit dependent to frequency and  $t$  is time in seconds.

SPWM is the most common PWM technique to generate switching signals in UPS. But, the continuous switching in SPWM causes the high losses in switches of inverter. In this paper, Modified SPWM is performed to reduce the switching of components in UPS. Figure 3 presents the controller scheme of Modified SPWM which pulse widths don't change significantly nearer the peak of switching signals. This is achieved by modification of carrier signal which applied during first and last  $60^\circ$  intervals per half-cycle [10]. Switching signals are generated with comparison of modified carrier and reference sine signal, as shown in waveforms.  $A_c$  and  $A_r$  indicates the amplitudes of carrier and reference signals, respectively.  $A_r/A_c$  is control is defined as modulation index. The width of pulse signal is determined according to modulation index.

$$M = \frac{A_r}{A_c} \quad (6)$$

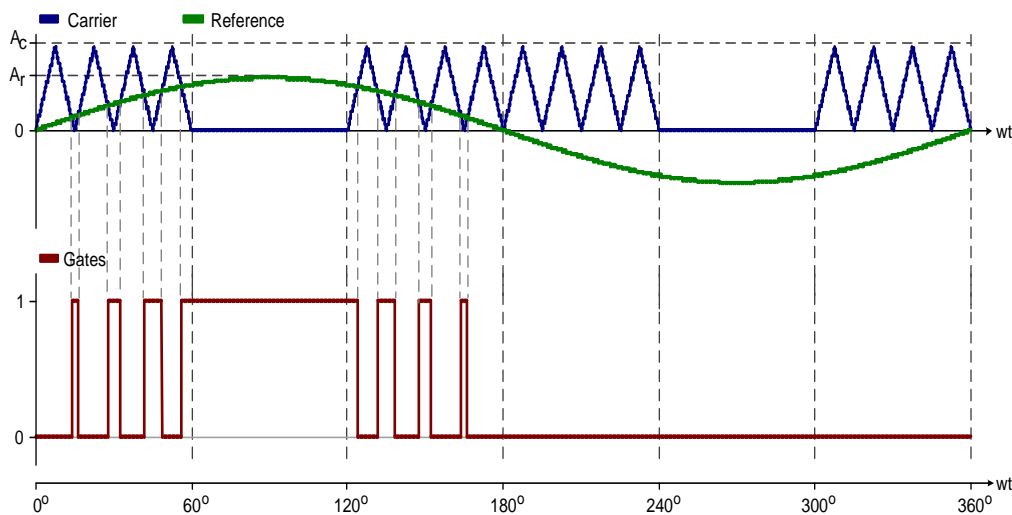

Figure 3. Modified SPWM

### 3. MODELING

The modeling and performance results of Standby UPS are tested by using PSCAD/EMDTTC 4.2.1 program. In testing, grid side voltage is selected as 220 Vrms, and sensitive load is 50  $\Omega$  (1 kVA). The system model of topology is presented in Figure 4.

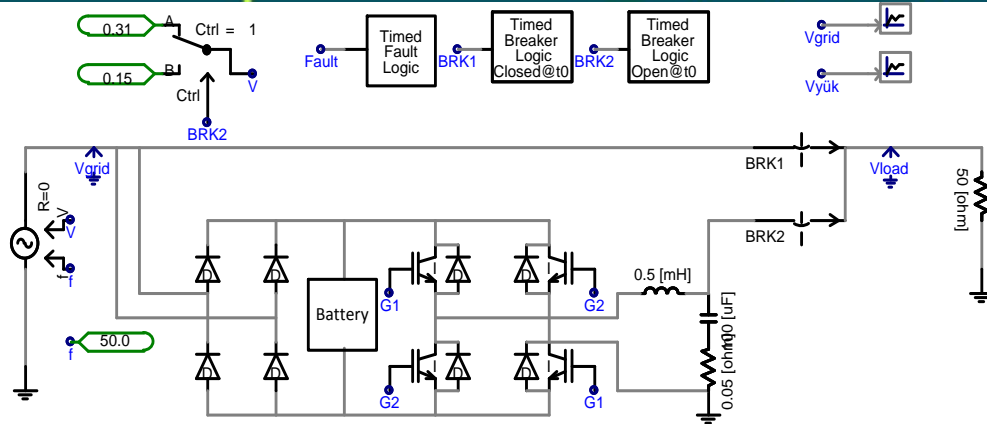

Figure 4. The scheme of Standby UPS constructed in PSCAD

The system parameters are given in Table 1.

Table 1. System parameters

System	Parameter	Value
Grid	Voltage	220 Vrms
	Frequency	50 Hz
Load	Resistor	50 ohm
	Power	1 kVA
UPS	Filter	L:0.5 mH, C: 100 uF
	Battery Voltage	300 V
	Inverter Switching Frequency	3 kHz
	Modulation Technique	SPWM

The performance results are tested according to 100% voltage interruption and 50% voltage sag conditions. In first case study of performance results, grid side voltage is interrupted for four cycles. The voltage waveforms of grid-side, output and battery are illustrated in Figure 5. Considering voltage waveforms, switch position changes from position-1 to position-2 during voltage interruptions. Owing to this transition, voltage level is maintained in instant interruptions. The waveforms of switch position for voltage interruption and normal condition are shown in Figure 6. A reduction in battery voltage seems during this period due to energy demand.

The second case study presents 50% voltage sag condition as shown in Figure 7. It shows the voltage waveforms of grid-side, load-side and battery. In case of voltage sag, the voltage magnitude reduces to 110 Vrms from 220 Vrms with 50% drop. At  $t=8.0$  s, UPS becomes active while voltage sag occurs at grid-side. As illustrated in Figure 8, the switch position passes to second condition to keep voltage magnitude constant.

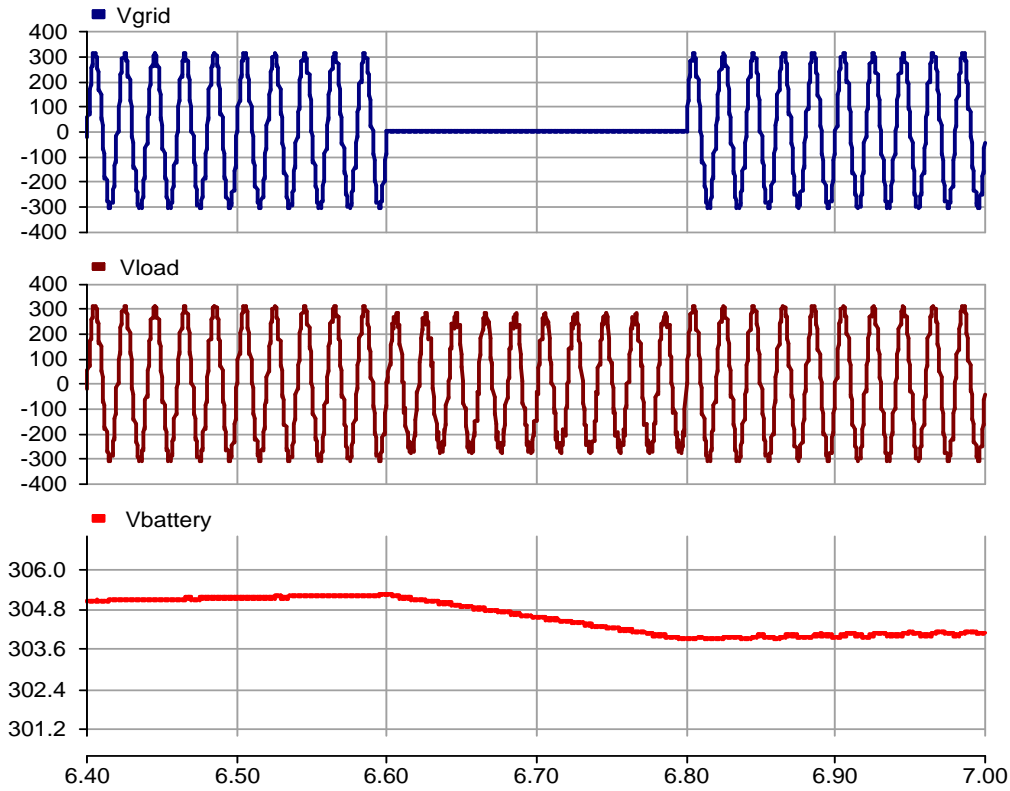

Figure 5. Grid, load and battery voltages during voltage interruptions

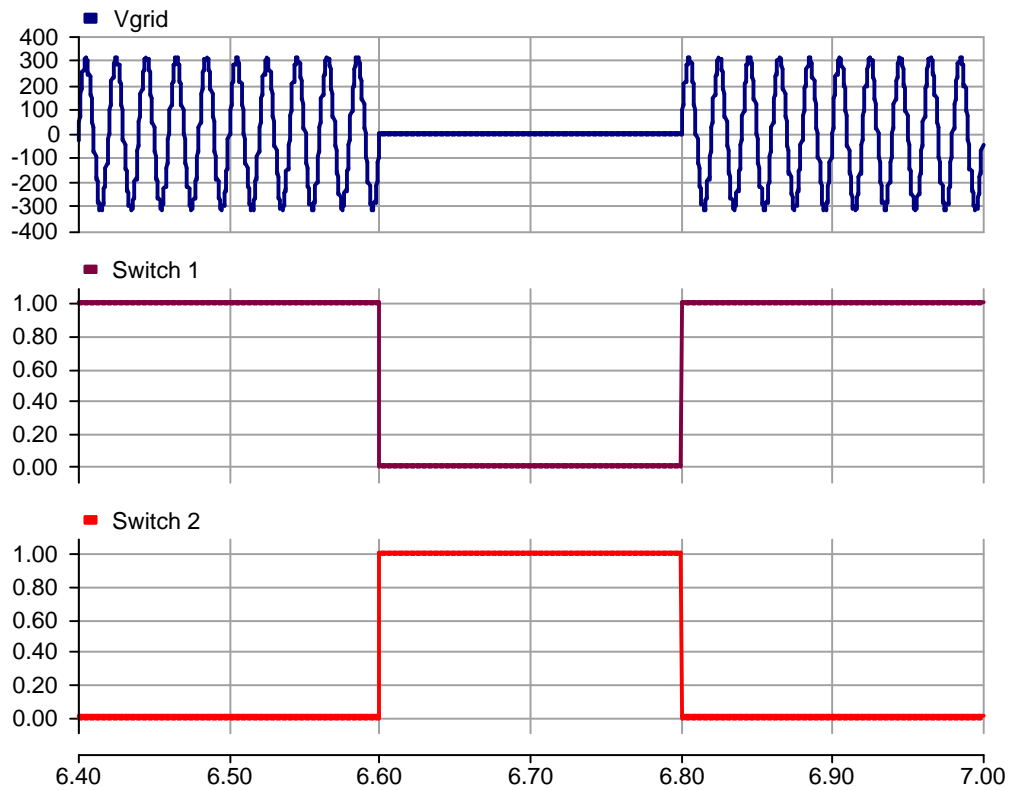

Figure 6. The switching conditions during voltage interruptions (0=Open, 1=Closed)

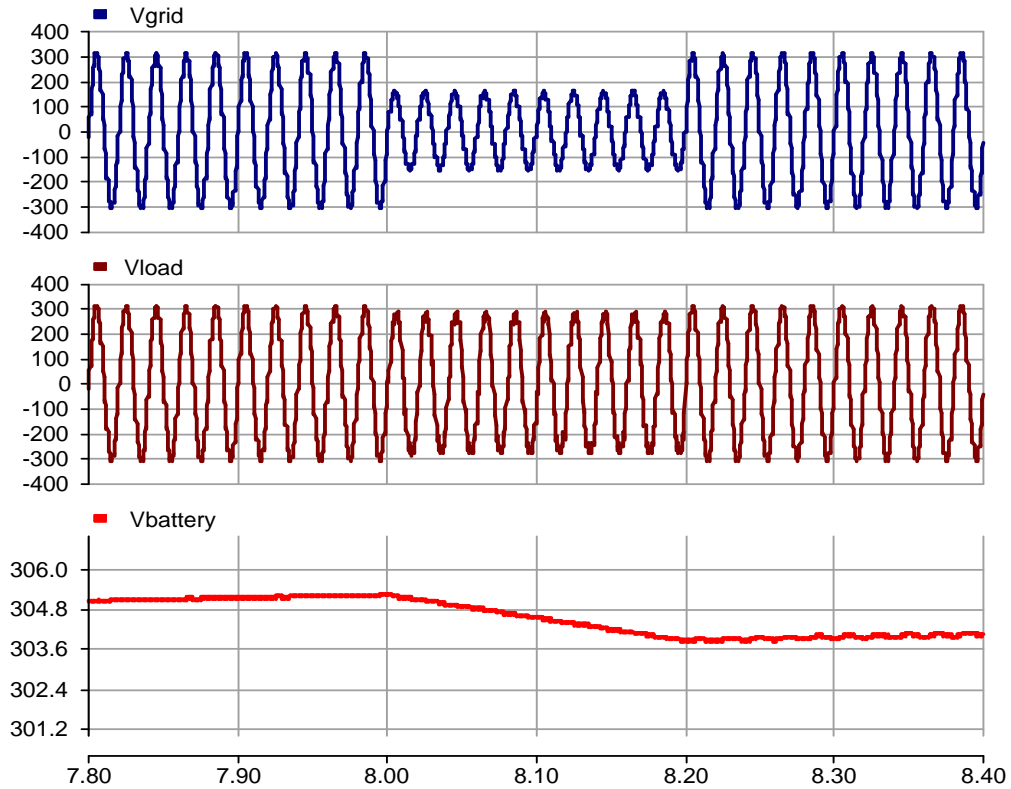

Figure 7. Grid, load and battery voltages during voltage sags

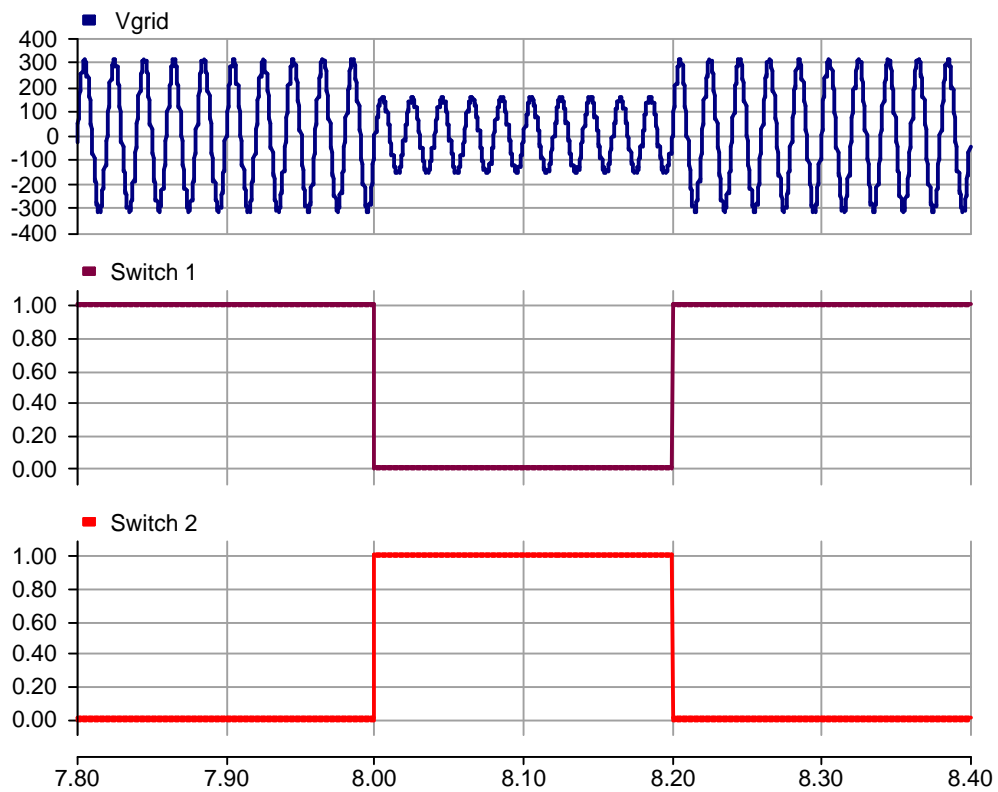

Figure 8. The switching conditions during voltage sags (0=Open, 1=Closed)

#### 4. CONCLUSION

In this paper, the case studies of Modified SPWM based Standby Ups are performed and tested to reduce switching losses in a conventional UPS. The proposed system is designed according to convenient values such as 220 Vrms/50 Hz and 1 kVA. The performance results for different case studies are presented by using PSCAD/EMDTC program. The results are performed for full interruption and 50% voltage sag conditions.

#### REFERENCES

- [1] J. V. Milanovic and C. P. Gupta, "Probabilistic assessment of financial losses due to interruptions and voltage sags-part I: the methodology," *IEEE Transactions on Power Delivery*, vol. 21, pp. 918-924, 2006.
- [2] S. Ouyang, P. Liu, L. Liu, and X. Li, "Test and analysis on sensitivity of low-voltage releases to voltage sags," *IET Generation, Transmission & Distribution*, vol. 9, pp. 2664-2671, 2015.
- [3] M. İnci, T. Köroğlu, K. Ç. Bayındır, and M. Tümay, "Şebeke Gerilim Değişimlerini Sezme Amaçlı Kontrol Metodlarının İncelenmesi ve Performanslarının Değerlendirilmesi," presented at the V. Enerji Verimliliği ve Kalitesi Sempozyumu, Kocaeli, 2013.
- [4] I. Standards, "IEEE Recommended Practices and Requirements for Harmonic Control in Electrical Power Systems," in *IEEE Std 519-1992*, ed, 1993, pp. 1-112.
- [5] M. A. Abusara, J. M. Guerrero, and S. M. Sharkh, "Line-Interactive UPS for Microgrids," *IEEE Transactions on Industrial Electronics*, vol. 61, pp. 1292-1300, 2014.
- [6] K. Bong-Hwan, C. Jin-Ha, and K. Tae-Won, "Improved single-phase line-interactive UPS," *IEEE Transactions on Industrial Electronics*, vol. 48, pp. 804-811, 2001.
- [7] Y. H. Chen and P. T. Cheng, "Flux Estimation Techniques for Inrush Current Mitigation of Line-Interactive UPS Systems," *IEEE Transactions on Industry Applications*, vol. 47, pp. 901-911, 2011.
- [8] F. Kamran and T. G. Habetler, "A novel on-line UPS with universal filtering capabilities," *IEEE Transactions on Power Electronics*, vol. 13, pp. 410-418, 1998.
- [9] S. A. Hamed and Y. Al-Shiboul, "Off-line UPS system with optimum utilization of power elements," in *Opportunities and Advances in International Electric Power Generation, International Conference on (Conf. Publ. No. 419)*, 1996, pp. 150-153.
- [10] M. H. Rashid, *Power Electronics: Circuits, Devices & Applications (3rd Edition)*: Prentice Hall of India; 3rd Edition edition (2008), 2008.

## A Comprehensive Review of Power Quality Problems and Solution Techniques in Grid Connected Wind Systems

Mustafa Inci<sup>1</sup>, Mehmet Buyuk<sup>1</sup>, Mehmet Tumay<sup>1</sup>

### Abstract

In this study, a comprehensive review of power quality (PQ) problems shown in grid connected wind energy systems (GCWESs) are presented and discussed. In GCWES, grid connection is an important issue which causes problems together with increasing higher power ratings of wind turbines. However, the integration of electrical grid and wind turbine in high power ratings creates serious problems, and affects stability of the wind system. The influence between grid and wind turbine in grid-tied wind systems significantly effects the PQ of turbine generator. PQ problems cause damage of power equipments, losses in electrical components, malfunction of devices and instability problems in systems. In addition to the sources and effects of these problems, standards and solution techniques for compensation are also explained in detailed.

**Keywords:** Grid connected wind energy systems, PQ problems, Solution techniques, Stability

### 1. INTRODUCTION

Wind energy industry has become one of the most important renewable energy sources with the development of technology and reduction of fossil fuels. Wind energy systems are being connected to the electrical systems, called as grid connected wind energy systems (GCWESs), are utilized to reduce the demand of utility-fed electricity for machines, illumination, heating and refreshment. The power ratings of these systems have demonstrated significant increment in renewable energy industry, which has started to improve in 1980s. But, the connection to the grid has become a serious problem due to high power ratings of wind turbines. The deviations and waveform distortions of physical and characteristics properties in electric grids that cause equipment failure, economical loss and several negative effects are defined as power quality (PQ) problems. In GCWESs, the PQ problems occurred at grid-side significantly affect power system stability of wind energy systems during interaction between grid and turbine [1]. In grid connected wind energy systems, it is characterized in expressions of voltage and frequency. The most hazardous voltage problems which affects the stability of wind turbine are voltage variations. Flickers, Harmonics and transients are different voltage problems at GCWESs. In addition to voltage problems, frequency variations are another PQ problems which affects the efficiency of wind system.

The PQ standards and grid requirements of grid connected systems are specified by IEC Standard 61400-21 of IEC-Technical Committee 88. In this paper, survey of PQ problems at GCWESs are proposed. The PQ problems are categorized in Section II, and the definitions/effects of these problems are detailed.

### 2. PQ PROBLEMS

Figure 1 illustrates the classification of PQ problems in GCWESs.

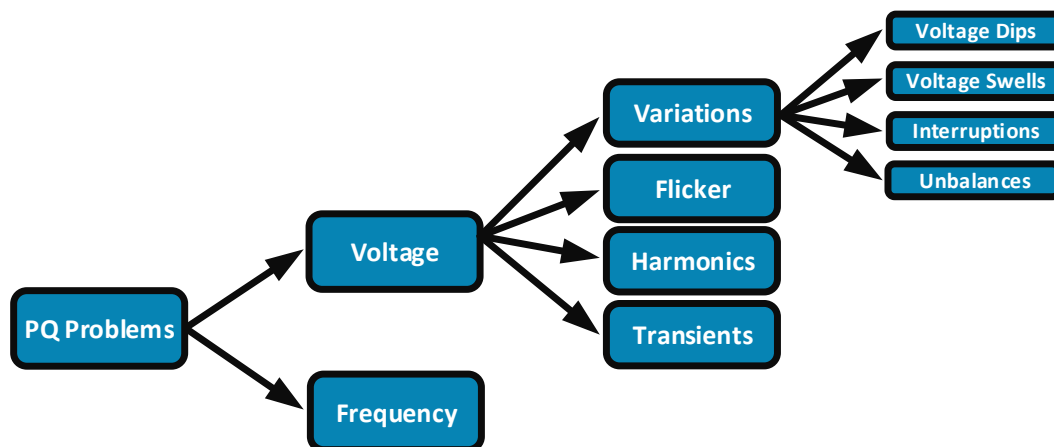

<sup>1</sup>Corresponding author: Çukurova University, Department of Electrical and Electronics Engineering, 01330, Balcalı, Sarıçam/Adana, Turkey. [minci@cu.edu.tr](mailto:minci@cu.edu.tr)

Figure 1. PQ problems in grid connected wind systems

## 2.1. Voltage Problems

Voltage problems are known as changes in the magnitude of voltage signals in a time duration from half period to minutes. These problems at grid-side significantly affect power system stability of wind energy systems during the interaction with grid. The most well-known PQ problems are known as variations, flicker, harmonics and transients.

### 2.1.1 Voltage Variations

Voltage variations at grid-side are mainly caused by changes in loads and power generation units [1]. Among voltage variations, voltage dips are defined as short duration reduction in rated voltage magnitude between 10% and 90%. Figure 2 presents the voltage waveform of voltage dip problem in electrical systems. This problem cause high generator currents and electrical torque by losing voltage stability in GCWESs [2, 3]. After occurrence of voltage dips, wind turbines are required to remain grid connected during voltage variations and to prevent high stator/rotor currents and power losses without losing the voltage stability of turbine. This condition is defined as low voltage ride through (LVRT) capability. The second voltage variations are defined as voltage swells. These are determined as short duration rise in magnitude to 110% and 190% of its rated value, as shown in Figure 3. Grid voltage swell causes a transient dc flux component on generator stator winding even stronger than grid voltage dip, resulting in a much more serious stator, rotor current, and torque oscillation [4]. In power electronics converter based wind energy generation systems, the reactive power will be absorbed by the power converter system from the grid during swell period [5]. In order to prevent the negative influences of voltage swells, over voltage withstanding capability of wind turbine is defined as high voltage ride through (HVRT) capability [6]. The duration of voltage dip/swell varies from half-period to 1 minute in IEEE 519 standards [7]. In electrical systems, voltage sag/swell is defined as according to (1-2):

$$\text{Magnitude} \leq 0.9pu \text{ for sag condition} \tag{1}$$

$$\text{Magnitude} \geq 1.1pu \text{ for swell condition} \tag{2}$$

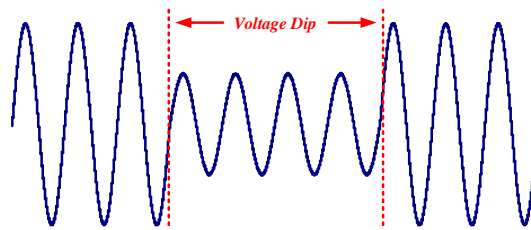

Figure 2. Voltage dip

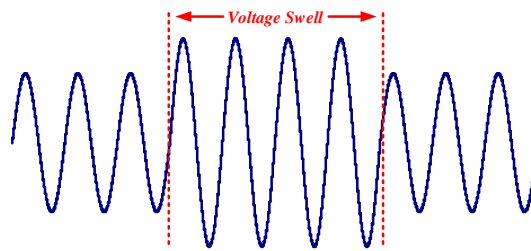

Figure 3. Voltage Swell

Voltage interruption is defined as the completely loss of grid side voltage [8], as shown in Figure 4. According to its time interval, it can be classified as instantaneous, momentary, temporary and sustained [9, 10].

- Instantaneous - 0.5 to 30 cycles
- Momentary - 30 cycles to 2 seconds
- Temporary - 2 seconds to 2 minutes
- Sustained - greater than 2 minutes

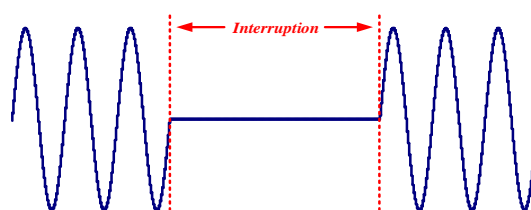

Figure 4. Interruption

In a three phase system, if the magnitudes of phase voltages and/or phase angles are different, this condition is called as voltage unbalance [11]. The waveforms of voltage unbalance situation is shown in Figure 5. The main sources of this problem are high-rated unbalanced loads in electrical systems [12]. This unbalance condition creates negative sequence currents in electrical machines which cause unequal overheating and torque in stator windings of generator [12, 13].

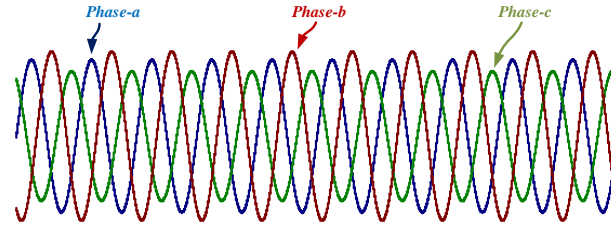

Figure 5. Voltage unbalances in a three phase system

### 2.1.2. Flicker

The voltage flickers are dynamic variations in the network caused by wind turbine or by varying load [14, 15]. The voltage flickers are caused due to switching operation, pitch error, yaw error and fluctuation of wind speed [16]. The power fluctuations from wind turbine continuously occur in the course of operation. The amplitude of voltage fluctuation depends on grid strength, network impedance, phase-angle and power factor of the wind turbines, and the fluctuation of voltage flicker is in a frequency 10-35 Hz [14]. The measurement of PQ at GCWESs is defined by IEC 61400-21 and voltage fluctuation should be within +/-5% of nominal value in approximately 10 (ten) minutes [16, 17].

### 2.1.3 Harmonics

Voltage harmonics is defined as a distortion due to integer multiple components of the fundamental sinusoidal voltage waveform alternating at 50/60 Hz and repeats every cycle. Figure 6 shows a voltage waveform with harmonics which consists of fundamental and selective harmonics (3rd). Nonlinear loads, power electronic loads, rectifiers and inverters are well-known sources of harmonics [1]. These problems cause over heating of transformer/generators, fault operation of protective equipments and an increase in currents through shunt capacitors which lead to failure of such capacitors [12, 18].

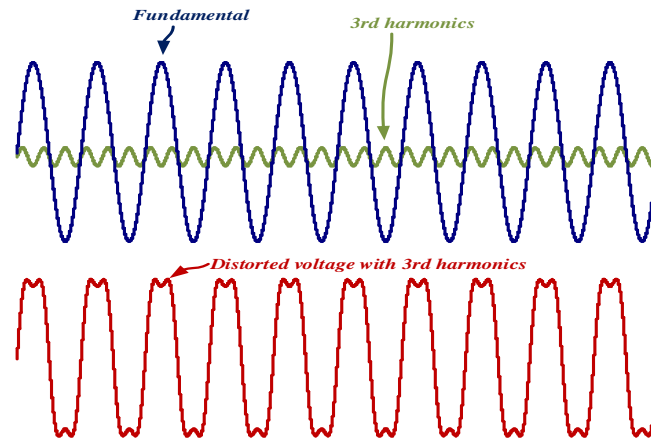

Figure 6. Waveforms of fundamental voltage, individual harmonics and distorted voltage with harmonics

The individual voltage components are used to calculate total harmonic distortion (THD) in percentage. THD limits are defined by using IEEE-519 standards [19]. The THD of a voltage ( $THD_V$ ) is defined as:

$$THD_V = \frac{\sqrt{\sum_{h=2} V_h^2}}{V_1} \times 100\% \quad (3)$$

Where,  $V_h$  is individual harmonic component of  $h^{th}$  component and  $V_1$  is fundamental component of a voltage.

### 2.1.4. Transients



Transients are known as sudden rises in voltage signals. Voltage Transients occur due to switching of capacitors using mechanical switches which provides reactive power compensation in wind energy generation systems [1, 12]. These problems can damage to sensitive electronic devices in control systems of wind systems [12].

### 2.1.5. Frequency Variations

Frequency variation can be expressed as a change in fundamental frequency of the utility from its defined nominal value (50 or 60 Hz) and the steady-state power system frequency is directly related to the rotational speed of the generators on the system [9, 20]. The frequency variations affects the power generation, non-optimal tip speed ratio and aerodynamic efficiency in a wind system [12, 21]. This condition causes less energy capture and lower power output for wind generation [21].

## 3. PQ STANDARDS

The development of wind energy requires to improve the PQ issue. The international standards specify the characteristics of PQ issue in GCWESs. These standards are defined by working group of Technical Committee-88 of the International Electrotechnical Commission (IEC) [14]. These standards consist of the following parts under the general titled as IEC-61400 [22, 23]:

- Part 1: Design requirements
- Part 2: Design requirements for small wind turbines
- Part 11: Acoustic noise measurement techniques
- Part 12: Wind turbine power performance testing
- Part 13: Measurement of mechanical loads
- Part 14: Declaration of apparent sound power level and tonality values
- Part 21: Measurement and assessment of PQ characteristics of GCWESs
- Part 23: Full-scale structural testing of rotor blades
- Part 24: Lightning protection

## 4. SOLUTION TECHNIQUES

There are several solution techniques to solve voltage problems in literature, as shown in Figure 7. It can be categorized as protection circuits, reactive power injection devices and control approaches. Crowbars [24, 25] and fault current limiters [26-28] are the most common and simple protection circuits in order to limit the high generator currents during fault. Dynamic voltage restorers [29-31] and Static Compensators [32, 33] are inverter based custom power devices which keep voltage magnitude at point common coupling. These inverter based devices are more expensive and complex compared to simple protection circuits. In addition, different control approaches [34] such as modified vector control structure, hysteresis control approach, sliding mode and fuzzy logic controllers are alternative ways to reduce the negative impacts of PQ problems.

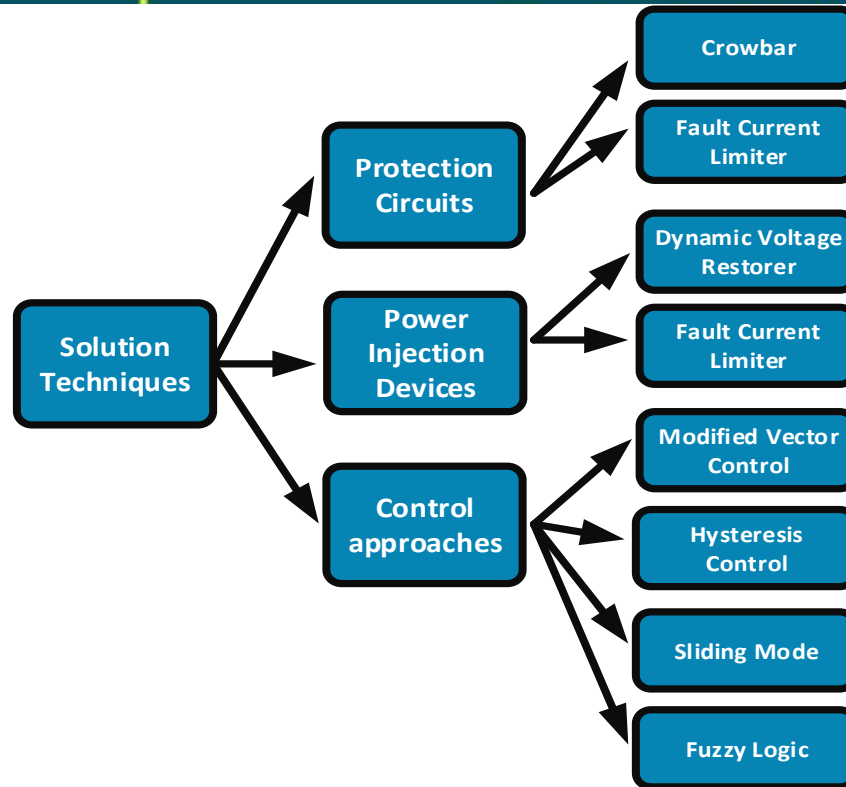

Figure 7. Solution Techniques for voltage problems

## 5. CONCLUSION

A comprehensive review of PQ problems in GCWESs are presented and discussed in this work. The PQ problems in grid connected systems are specified by IEC Standard 61400-21 of IEC-Technical Committee 88. These problems are classified according to voltage and frequency. The most hazardous voltage problems which affects the stability of wind turbine are voltage variations. Flickers, Harmonics and transients are different voltage problems at GCWESs. In addition to voltage problems, frequency variations are another PQ problems which affects the efficiency of wind system. In order to prevent the unfavorable influences of these problems, solution techniques are introduced in this paper.

## ACKNOWLEDGMENT

The authors would like to acknowledge the TÜBİTAK (Project Number: 115R304) for full financial support.

## REFERENCES

- [1] A. Larsson, "The power quality of wind turbines," PhD Thesis, Department of Electric Power Engineering, Chalmers University of Technology, Göteborg, Sweden, 2000.
- [2] N. S. Chouhan, "Doubly fed induction generator with integrated energy storage system for smoothening of output power," Master Science, Electrical and Computer Engineering, Missouri University of Science and Technology, Missouri, USA, 2010.
- [3] A. D. Hansen and G. Michalke, "Fault ride-through capability of DFIG wind turbines," *Renewable Energy*, vol. 32, pp. 1594-1610, Jul 2007.
- [4] Z. Xie, X. G. Zhang, X. Zhang, S. Y. Yang, and L. X. Wang, "Improved Ride-Through Control of DFIG During Grid Voltage Swell," *Ieee Transactions on Industrial Electronics*, vol. 62, pp. 3584-3594, Jun 2015.
- [5] A. Ahmad and R. Loganathan, "Development of LVRT and HVRT control strategy for DFIG based wind turbine system," in *Energy Conference and Exhibition (EnergyCon), 2010 IEEE International*, 2010, pp. 316-321.
- [6] Z. Zheng, G. Yang, and H. Geng, "High Voltage Ride-through Control Strategy of Grid-side Converter for DFIG-based WECS," *39th Annual Conference of the Ieee Industrial Electronics Society (Iecon 2013)*, pp. 5282-5287, 2013.
- [7] A. K. Sadigh and K. M. Smedley, "Fast and precise voltage sag detection method for dynamic voltage restorer (DVR) application," *Electric Power Systems Research*, vol. 130, pp. 192-207, Jan 2016.
- [8] R. R. S. Manoj Kumar Swain, Balaram Das, Rakesh Sahu, "Enhancement of Power Quality for Grid Connected Wind Energy System using Smart-STATCOM," *International Journal of Emerging Technology and Advanced Engineering*, vol. 3, pp. 232-235, 2013.
- [9] "IEEE Recommended Practice for Monitoring Electric Power Quality," in *IEEE Std 1159-2009 (Revision of IEEE Std 1159-1995)*, ed, 2009, pp. c1-81.
- [10] "IEEE Recommended Practice for Monitoring Electric Power Quality," in *IEEE Std 1159-1995*, ed, 1995, p. i.
- [11] P. Pillay and M. Manyage, "California Electricity Situation," *IEEE Power Engineering Review*, vol. 21, pp. 10-12, 2001.
- [12] M. G. Sugirtha and P. Latha, "Analysis of power quality problems in grid connected wind power plant," in *Recent Advancements in Electrical, Electronics and Control Engineering (ICONRAEeCE), 2011 International Conference on*, 2011, pp. 19-24.

- [13] R. V. R. Raju, A. Karthikeyan, and C. Nagamani, "Enhanced decoupled power control of wind turbine driven DFIG using DVR under unbalanced grid voltage," in *Advances in Power Conversion and Energy Technologies (APCET), 2012 International Conference on*, 2012, pp. 1-5.
- [14] S. W. Mohod and M. V. Aware, "A STATCOM-Control Scheme for Grid Connected Wind Energy System for Power Quality Improvement," *IEEE Systems Journal*, vol. 4, pp. 346-352, 2010.
- [15] Z. Chen, "Issues of Connecting Wind Farms into Power Systems," in *2005 IEEE/PES Transmission & Distribution Conference & Exposition: Asia and Pacific*, 2005, pp. 1-6.
- [16] T. P. Sunil and N. Loganathan, "Power quality improvement of a grid-connected wind energy conversion system with harmonics reduction using FACTS device," in *Advances in Engineering, Science and Management (ICAESM), 2012 International Conference on*, 2012, pp. 415-420.
- [17] H. Emanuel, M. Schellschmidt, S. Wachtel, and S. Adloff, "Power quality measurements of wind energy converters with full-scale converter according to IEC 61400-21," in *2009 10th International Conference on Electrical Power Quality and Utilisation*, 2009, pp. 1-7.
- [18] W. E. Reid, "Power quality issues-standards and guidelines," in *Pulp and Paper Industry Technical Conference, 1994., Conference Record of 1994 Annual*, 1994, pp. 108-115.
- [19] "IEEE Recommended Practices and Requirements for Harmonic Control in Electrical Power Systems," in *IEEE Std 519-1992*, ed, 1993, pp. 1-112.
- [20] "IEEE Trial-Use Recommended Practice for Voltage Sag and Short Interruption Ride-Through Testing for End-Use Electrical Equipment Rated Less than 1000 V," in *IEEE Std 1668-2014*, ed, 2014, pp. 1-92.
- [21] C. S. S. S. Tripathi, "Power Quality Improvement in Wind Grid Energy System using STATCOM With BESS -Control Scheme," *International Journal of Innovation and Scientific Research*, vol. 9, pp. 237-245, September, 2014 2014.
- [22] "Wind turbines – Part 1: Design requirements," in *International Standard IEC 61400-1*, ed. Geneva, Switzerland: International Electrotechnical Commission, 2005, pp. 1-92.
- [23] V. Yuvaraj, E. P. Raj, A. Mowlidharan, and L. Thirugnanamoorthy, "Power quality improvement for grid connected wind energy system using FACTS device," in *Proceedings of the Joint INDS'11 & ISTET'11*, 2011, pp. 1-7.
- [24] S. Li-ling, Y. Pu, and W. Yi, "Simulation research for LVRT of DFIG based on rotor active crowbar protection," in *Sustainable Power Generation and Supply (SUPERGEN 2012), International Conference on*, 2012, pp. 1-7.
- [25] W. Maoze, X. Wei, H. Jia, and Y. Xinghuo, "A new control system to strengthen the LVRT capacity of DFIG based on both crowbar and DC chopper circuits," in *IEEE PES Innovative Smart Grid Technologies*, 2012, pp. 1-6.
- [26] S. Divya and T. Krishna Kumari, "Combination of super capacitor-switch type fault current limiter for LVRT enhancement of DFIG wind turbines," in *2015 International Conference on Control Communication & Computing India (ICCC)*, 2015, pp. 343-348.
- [27] W. Guo, L. Xiao, S. Dai, Y. Li, X. Xu, W. Zhou, *et al.*, "LVRT Capability Enhancement of DFIG With Switch-Type Fault Current Limiter," *IEEE Transactions on Industrial Electronics*, vol. 62, pp. 332-342, 2015.
- [28] W. Guo, L. Xiao, and S. Dai, "Fault current limiter-battery energy storage system for the doubly-fed induction generator: analysis and experimental verification," *IET Generation, Transmission & Distribution*, vol. 10, pp. 653-660, 2016.
- [29] C. Wessels, F. Gebhardt, and F. W. Fuchs, "Fault Ride-Through of a DFIG Wind Turbine Using a Dynamic Voltage Restorer During Symmetrical and Asymmetrical Grid Faults," *Ieee Transactions on Power Electronics*, vol. 26, pp. 807-815, Mar 2011.
- [30] D. Ramirez, S. Martinez, C. A. Platero, F. Blazquez, and R. M. de Castro, "Low-Voltage Ride-Through Capability for Wind Generators Based on Dynamic Voltage Restorers," *Ieee Transactions on Energy Conversion*, vol. 26, pp. 195-203, Mar 2011.
- [31] N. Amutha and B. K. Kumar, "Improving fault ride-through capability of wind generation system using DVR," *International Journal of Electrical Power & Energy Systems*, vol. 46, pp. 326-333, Mar 2013.
- [32] A. F. Abdou, A. Abu-Siada, and H. R. Pota, "Application of STATCOM to improve the LVRT of DFIG during RSC fire-through fault," in *Universities Power Engineering Conference (AUPEC), 2012 22nd Australasian*, 2012, pp. 1-6.
- [33] J. I. Y. Ota, Y. Shibano, and H. Akagi, "Low-voltage-ride-through (LVRT) capability of a phase-shifted-PWM STATCOM using the modular multilevel cascade converter based on single-star bridge-cells (MMCC-SSBC)," in *2013 IEEE Energy Conversion Congress and Exposition*, 2013, pp. 3062-3069.
- [34] J. J. Justo, F. Mwasilu, and J.-W. Jung, "Doubly-fed induction generator based wind turbines: A comprehensive review of fault ride-through strategies," *Renewable and Sustainable Energy Reviews*, vol. 45, pp. 447-467, 5// 2015.

# The Performance Improvement of DVR Based Grid Connected Wind Energy Systems for Sustainable Energy

*Mehmet Buyuk<sup>1</sup>, Mustafa Inci<sup>2</sup>, Adnan Tan<sup>2</sup>, Mehmet Tumay<sup>2</sup>*

---

## Abstract

*The most well-known custom power devices are Dynamic Voltage Restorers (DVR) to fulfil voltage stability in grid connected wind systems. DVRs are series electronics devices located between grid and wind turbine. During voltage dip, DVR generates and injects controlled voltage to grid for system stability. However, the injected voltage must be sinusoidal and low harmonic distortion. In conventional DVRs, LC filter is used to eliminate harmonic distortions. But, switching ripples are observed at voltage waveforms of these conventional structures. This condition distorts the quality of injected voltage and stability of system. In this paper, the improvement of injected voltages is proposed by using LCL filters in DVR so as to eliminate the disadvantages of LC filters. In order to verify the effectiveness of LCL filter, the performance results are analysed and compared with LC filter based DVR system.*

**Keywords:** *Dynamic Voltage Restorer, Grid connected wind energy systems, LCL filter, Renewable energy*

---

## 1. INTRODUCTION

Grid connected wind energy systems become an important renewable energy source to reduce the demand of electricity usage with the development of technology and reduction of fossil fuels. In grid connected wind systems, the interaction of grid and wind system influences all system parameters and causes serious problems at generator side of wind turbine which affects the stability [1, 2]. Among these problems, voltage dips are the most important problems which must be compensated to provide voltage stability. Voltage dips are defined as reduction of voltage magnitude for a short duration [3]. This voltage disturbance at grid-side induces high stator/rotor currents with losing the stability of generator. In order to mitigate the negative effects of voltage dips, custom power devices are used to keep grid-side voltage constant. The most well-known custom power devices are Dynamic Voltage Restorers (DVR) to fulfil voltage stability in grid connected wind systems [1, 4-6]. DVRs are series electronics devices located between grid and wind turbine [7]. During voltage dips, DVR generates and injects controlled voltage to grid for system stability [8]. However, the injected voltage must be sinusoidal and low harmonic distortion. In conventional DVRs, LC filter is used to eliminate harmonic distortions [9]. But, switching ripples are observed at voltage waveforms of these conventional structures. Ripple mitigation performance of LC filter is insufficient. This condition distorts the quality of injected voltage and stability of system. In this paper, the The Performance Improvement of injected voltages is proposed by using LCL filters in DVR so as to eliminate the disadvantages of LC filters and ensure better attenuation of oscillations. In order to verify the effectiveness of LCL filter, the performance results are analysed and compared with LC filter based DVR system. The overall system shown in Fig.1 is constructed and tested in PSCAD simulation environment.

---

<sup>1</sup>Corresponding author: Çukurova University, Department of Electrical-Electronics Engineering, 01030, Sarıçam/Adana, Turkey.  
[mbuyuk@cu.edu.tr](mailto:mbuyuk@cu.edu.tr)

<sup>2</sup>Çukurova University, Department of Electrical-Electronics Engineering, 01030, Sarıçam/Adana, Turkey,  
[minci@cu.edu.tr](mailto:minci@cu.edu.tr), [atan@cu.edu.tr](mailto:atan@cu.edu.tr), [mtumay@cu.edu.tr](mailto:mtumay@cu.edu.tr)

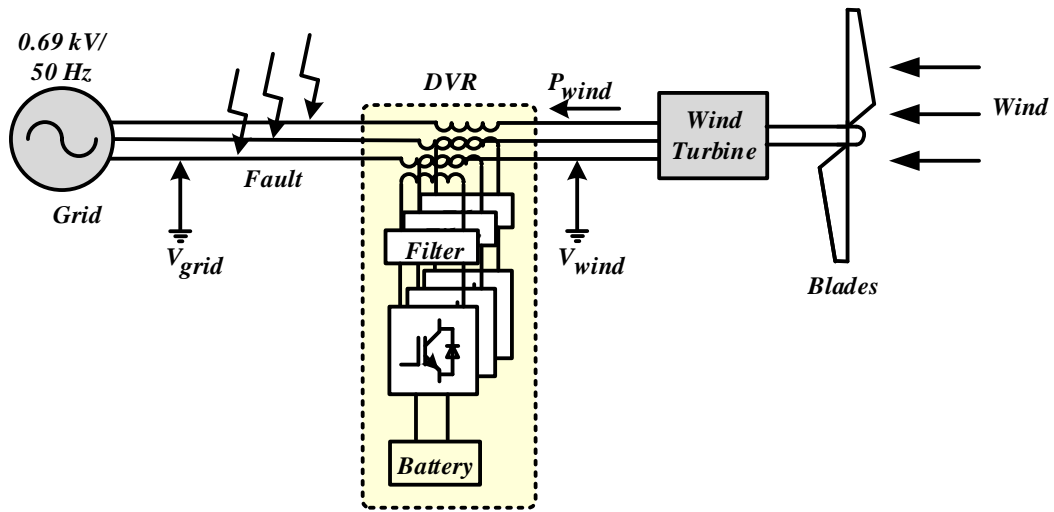

Figure 1. DVR located between grid and turbine

## 2. DVR with LCL FILTER

The single-phase circuit diagrams of DVR with LC filter and LCL filter is illustrated in Fig. 2, where it consists of an inverter, energy storage unit, LC filter or LCL filter and injection transformer.

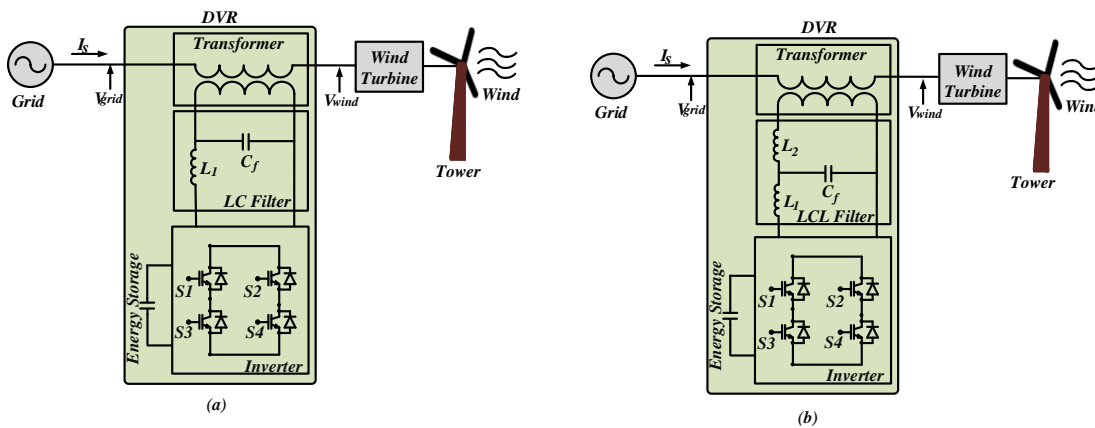

Figure 2. DVR system based on (a) LC filter, (b) LCL filter

The equivalent circuit diagram of LCL filter is shown in Fig. 3, where the injection transformer is considered as single inductance series with grid-side inductance of LCL filter.  $V_{dvr}$  and  $V_i$  denote DVR output voltage and inverter output voltage, respectively.  $L_1$ ,  $C_f$ ,  $L_2$  and  $L_{tr}$  represent inverter-side inductance, filter capacitance, grid-side inductance and transformer equivalent leakage inductance, respectively. The equivalent series resistances of inductances are assumed as zero for simplifying the analysis.

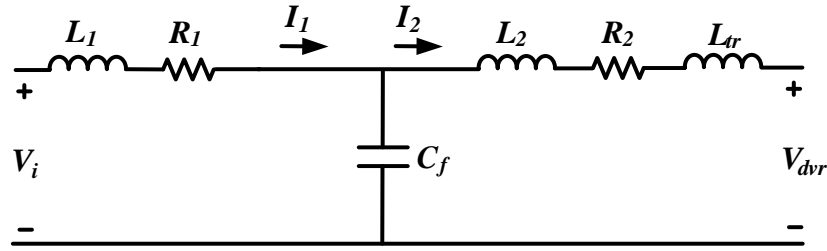

Figure 3. Single-phase circuit scheme of LCL filter

By assuming the inductances as ideal, the transfer function of LCL filter is then derived as,

$$H(s) = \frac{1}{L_1 C_f (L_2 + L_{tr}) s^3 + (L_1 + L_2 + L_{tr}) s} \quad (1)$$

Accordingly, the resonance frequency can be obtained as,

$$\omega_{res} = \sqrt{\frac{L_1 + L_2 + L_{tr}}{L_1 C_f (L_2 + L_{tr})}} \quad (2)$$

The frequency characteristics of the LC filter and LCL filter are demonstrated in Fig. 4. It can be seen that LCL filter has -60 dB/decade attenuation at high frequencies which is better than -40 dB/decade LC filter attenuation [10]. However, it can be seen that both filters have resonant peak which comprises the system stability. In order to prevent the system from instability, simple resistor is connected in series with the filter capacitor to damp the resonance [11].

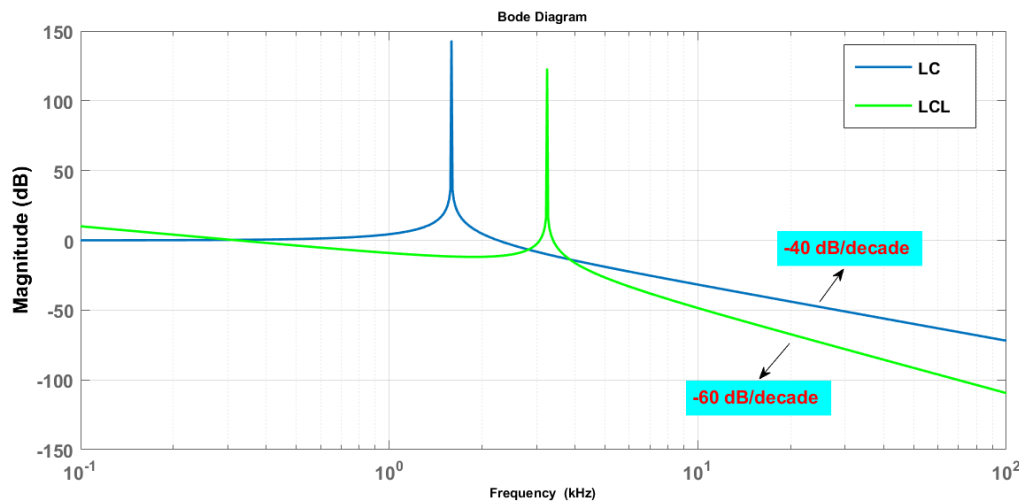

Figure 4. LCL filter frequency characteristic

### 3.LCL FILTER DESIGN RULES

Some considerations should be taken into account while the design of LCL filter for grid-tied PWM inverter [12-15]. These rules can be summarised as below;

- The voltage drop caused from the filter inductance should be limited to be under 10% of the supply voltage.
- The impedances of capacitor and grid-side inductance of the filter at the  $\omega_{sw}$  should ensure  $X_c(\omega_{sw}) = 0.1 \sim 0.2 X_L(\omega_{sw})$ .
- The resonance frequency ( $\omega_{res}$ ) should be  $10\omega_1 < \omega_{res} < 0.5\omega_{sw}$ , where  $\omega_1$  and  $\omega_{sw}$  are supply fundamental frequency and inverter switching frequency, respectively.
- The filter capacitance should be limited so that the reactive power absorbed by the capacitor will be less the system rated active power.

$$C_f \leq \frac{0.05P_{rated}}{3\omega_1 V_s}$$

- The damping resistor value should be at least selected one-third of the filter capacitance at resonance frequency.

#### 4.SIMULATION RESULTS

This section introduces the simulation results of LC filter and LCL based DVR for grid connected wind energy system. In order to verify the system shown in Fig. 1, the system is constructed in PSCAD, where Table I shows the system rated values. The grid voltage and frequency are 690 V and 50 Hz, respectively. The wind turbine rating is 1 MVA. The DVR rating is designed so to compensate 30 % voltage dip, which is 300 kVA.

Table I. Rating values of the simulated system

Parameter	Value
Grid Voltage	0.69 kV (rms)
Grid Frequency	50 Hz
Wind Turbine Rating	1 MVA
DVR Rating	300 kVA
Switching Frequency	5 kHz

The voltage dip is formed by a sag generator, which is 30 % of the grid voltage. The performance of DVR is tested with both LC filter and LCL filter separately. The values used for LC and LCL filters are demonstrated in Table II. The total inductances of both filter is same.

Table II. Parameter values of LC filter and LCL filter

Filter Type	LC Filter			LCL Filter			
	L1	Cf	Rd	L1	L2	Cf	Rd
Values	0.5 mH	20 uF	0.25 Ω	0.3 mH	0.2 mH	20 uF	0.25 Ω

Fig. 5 and Fig. 6 illustrate the simulation results of the system when LC filter and LCL filter are used, respectively. Three-phase symmetrical voltage dip starts at 0.3 seconds and continues 4-cycles. The rms values of each phase drops to 483 V from 690 V. It can be seen from Fig. 5 and Fig. 6 that DVR system with LCL filter has purer injected voltage waveform in comparison with DVR system with LC filter. The THD values of LC and LCL filter based DVRs are 2.13% and 1.42%, respectively. Thus, the waveforms of wind side voltage have lower THD value once LCL filter is applied with DVR.

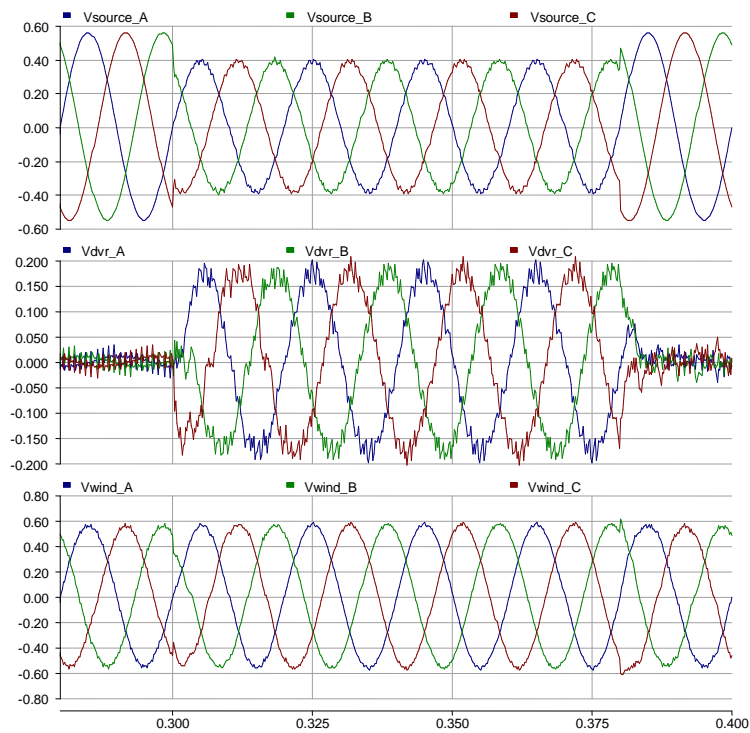

Figure 5. Performance results for LC filter based DVR

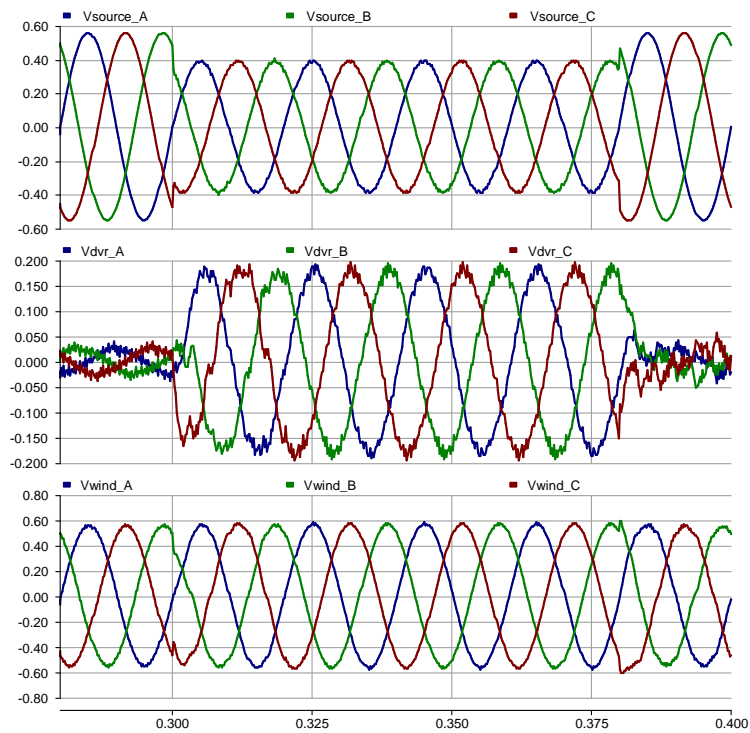

Fig. 6. Performance results for LCL filter based DVR



## 5. CONCLUSION

In this paper, LCL filter based DVR in wind energy system has presented and compared with LC filter system. The frequency characteristics of both filters are demonstrated. Besides, the design of LCL filter for DVR is given, and limits for the filter parameters are explained. The effectiveness of the proposed system is tested and compared with conventional system. According to simulation results, the THD value of the wind-side voltage of the proposed system is 1.42% while the THD of the conventional system is 2.13%, which ensures better stability condition for wind energy system.

## ACKNOWLEDGMENT

This study is financially supported by the Scientific Research Project Unit at Çukurova University (Project Number: FBA-2016-6699).

## REFERENCES

- [1] A. E. Leon, M. F. Farias, P. E. Battaiotto, J. A. Solsona, and M. I. Valla, "Control Strategy of a DVR to Improve Stability in Wind Farms Using Squirrel-Cage Induction Generators," *Ieee Transactions on Power Systems*, vol. 26, pp. 1609-1617, Aug 2011.
- [2] S. I. Gkavanoudis and C. S. Demoulias, "Fault ride-through capability of a DFIG in isolated grids employing DVR and supercapacitor energy storage," *International Journal of Electrical Power & Energy Systems*, vol. 68, pp. 356-363, Jun 2015.
- [3] W. Dong-Jun, A. Seon-Ju, C. Il-Yop, K. Joong-Moon, and M. Seung-Il, "A new definition of voltage sag duration considering the voltage tolerance curve," in *Power Tech Conference Proceedings, 2003 IEEE Bologna*, 2003, p. 5 pp. Vol.3.
- [4] N. H. Saad, A. A. Sattar, and A. E.-A. M. Mansour, "Low voltage ride through of doubly-fed induction generator connected to the grid using sliding mode control strategy," *Renewable Energy*, vol. 80, pp. 583-594, 8/ 2015.
- [5] C. Wessels, F. Gebhardt, and F. W. Fuchs, "Fault Ride-Through of a DFIG Wind Turbine Using a Dynamic Voltage Restorer During Symmetrical and Asymmetrical Grid Faults," *Ieee Transactions on Power Electronics*, vol. 26, pp. 807-815, Mar 2011.
- [6] J. J. Justo, F. Mwasilu, and J. W. Jung, "Doubly-fed induction generator based wind turbines: A comprehensive review of fault ride-through strategies," *Renewable & Sustainable Energy Reviews*, vol. 45, pp. 447-467, May 2015.
- [7] D. Somayajula and M. L. Crow, "An Ultracapacitor Integrated Power Conditioner for Intermittency Smoothing and Improving Power Quality of Distribution Grid," *IEEE Transactions on Sustainable Energy*, vol. 5, pp. 1145-1155, Oct 2014.
- [8] B. J. Quirl, B. K. Johnson, and H. L. Hess, "Mitigation of Voltage Sags with Phase Jump Using a Dynamic Voltage Restorer," in *2006 38th North American Power Symposium*, 2006, pp. 647-654.
- [9] S. S. Choi, B. H. Li, and D. M. Vilathgamuwa, "Design and analysis of the inverter-side filter used in the dynamic voltage restorer," *Ieee Transactions on Power Delivery*, vol. 17, pp. 857-864, Jul 2002.
- [10] M. Büyük, A. Tan, M. Tümay, and K. Ç. Bayındır, "Topologies, generalized designs, passive and active damping methods of switching ripple filters for voltage source inverter: A comprehensive review," *Renewable and Sustainable Energy Reviews*, vol. 62, pp. 46-69, 9// 2016.
- [11] M. Liserre, F. Blaabjerg, and S. Hansen, "Design and control of an LCL-filter-based three-phase active rectifier," *IEEE Transactions on Industry Applications*, vol. 41, pp. 1281-1291, 2005.
- [12] B. G. Cho, S. K. Sul, H. Yoo, and S. M. Lee, "LCL filter design and control for grid-connected PWM converter," in *Power Electronics and ECCE Asia (ICPE & ECCE), 2011 IEEE 8th International Conference on*, 2011, pp. 756-763.
- [13] H. R. Karshenas and H. Saghafi, "Basic Criteria in Designing LCL Filters for Grid Connected Converters," in *2006 IEEE International Symposium on Industrial Electronics*, 2006, pp. 1996-2000.
- [14] F. Liu, X. M. Zha, Y. Zhou, and S. X. Duan, "Design and Research on Parameter of LCL Filter in Three-Phase Grid-Connected Inverter," *2009 Ieee 6th International Power Electronics and Motion Control Conference, Vols 1-4*, pp. 1224-1227, 2009.
- [15] A. Papavasiliou, S. A. Papathanassiou, S. N. Manias, and G. Demetriadis, "Current Control of a Voltage Source Inverter Connected to the Grid via LCL Filter," in *2007 IEEE Power Electronics Specialists Conference*, 2007, pp. 2379-2384.

# Improved SRF to Extract Harmonics in Active Power Filters for Single Phase Systems

Mustafa Inci<sup>1</sup>, Mehmet Buyuk<sup>1</sup>, Mehmet Tumay<sup>1</sup>

---

## Abstract

*In this paper, SRF technique is improved to extract harmonics signals in single phase systems. Traditional SRF Theory is the most widespread harmonics extraction method in three phase systems. The main drawback of this method is not applicable for single phase systems. To eliminate the drawback of traditional SRF, this study proposes improved SRF (ISRF) to extract voltage harmonics in both single phase and unbalanced three phase systems. The proposed method is tested in series APF to compensate the voltage harmonics at load voltage. THD level is reduced to 2.37% from 13.14% which is fairly lower explained in IEEE 1159-2009 standards. The performance results verify the efficacy and accuracy of proposed controller by using PSCAD/EMTDC.*

**Keywords:** Improved SRF; Series APF; Single phase system; Voltage harmonics

---

## 1. INTRODUCTION

Recently, power quality problems have become a serious issue with the increase of nonlinear loads. Among power quality problems, voltage harmonics is an important disturbance which distorts the waveform due to integer multiple components of fundamental voltage frequency. These disturbances cause several serious problems which are equipment failure and economical loss in industrial/commercial consumers [1–3]. There are several power electronics based devices called as custom power devices for compensation process. The most effective way to eliminate voltage harmonics is the installation of a series active power filter (APF) in the system. Series APF is connected in series between nonlinear load and grid to compensate voltage harmonics in distribution system.

In distribution systems, instantaneous voltage signals at load-side are required to be measured for the achievement of voltage harmonics compensation. Then, the measured signals are used to generate reference signals of voltage harmonics in controller process. In the controller algorithm of Series APF, the reference compensation voltage is calculated, and the reverse of voltage harmonics is injected in phase to system for compensation [4], [5]. The most common extraction method in literature is Synchronous Reference Frame (SRF). SRF is the most effective method to extract the harmonics in three phase systems. But, conventional SRF theory calculates the average value of three phase voltage signals, and it is not applicable for single phase and unbalanced three phase systems [6–10]. Therefore, SRF theory is improved for single phase systems in this study. The improved controller is applicable in both single phase and unbalanced three phase systems.

## 2. PROPOSED METHOD FOR HARMONICS EXTRACTION

Figure 1 shows the structure of 5-level cascaded multilevel inverter based Series APF. Series APF is series connected between load and grid, and it is applied to compensate voltage harmonics at load-side [11–14]. The main aim of series APF is to mitigate the negative effects of voltage harmonics and to obtain pure sine waveform at source-side by injecting reverse voltage of harmonics. The most important issues in APF are measurement of voltage signals and reference signal generation of voltage harmonics. SRF is the most common and effective method to produce harmonic references in three phase electrical grids. The conventional SRF method employs three phase voltage ( $V_a, V_b, V_c$ ) to convert d- and q- components for three phase systems.

---

<sup>1</sup>Corresponding author: Çukurova University, Department of Electrical and Electronics Engineering, 01330, Balcalı, Sarıçam/Adana, Turkey. [minci@cu.edu.tr](mailto:minci@cu.edu.tr)

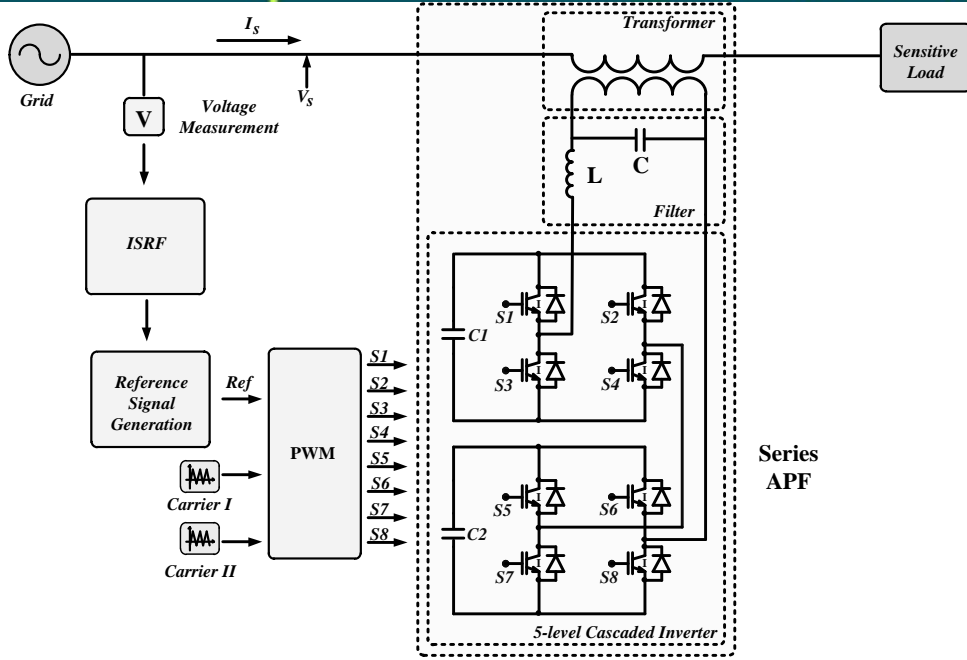

Figure 1. 5-level H-bridge multilevel inverter based series apf and its controller algorithm

In order to eliminate the shortcomings of SRF method, an improved SRF (ISRF) is developed and explained in this study. The study proposes improved SRF method which is applicable in both single phase and three-phase systems for APF applications. Proposed controller extracts the harmonics of a single phase voltage in this study. Besides, it is also feasible for three phase systems.

There is only one voltage signal measurement in single phase systems. In ISRF method, three phase symmetric voltages for input\_2 and input\_3 in dq transformation are constructed using the known phase information[15]. According to balanced three phase system, there is  $120^\circ$  phase difference between following two phases. Relationship in balanced three phase voltages is presented in (1) to (3). In this way, a single phase system is considered as three phase system. Thus, reference signals for input\_2 and input\_3 are derived using mathematical expression which clarified in (1-3).

$$input\_1 = V_{sa} \angle(0) \quad (1)$$

$$input\_2 = V_{sa} \angle(-\frac{2\pi}{3}) \quad (2)$$

$$input\_3 = V_{sa} \angle(\frac{2\pi}{3}) \quad (3)$$

According to above expression, reference signals for input\_2 and input\_3 are rewritten in phasor form. Because of  $\angle\pi = -1$ , the value of input\_2 is to be delay  $\pi/3$  multiplying by (-1). In a balanced system, the sum of phasor voltages is zero ( $input\_1 + input\_2 + input\_3 = 0$ ). As a result of this supposition, the value of input\_3 becomes the negative of the sum of input\_1 and input\_2 due to  $input\_3 = -(input\_1 + input\_2)$ . The expressions of input\_2 and input\_3 in phasor form are explained in (4)

$$input\_3 = -(input\_1 + input\_2) = -V_s + V_s \angle(\frac{\pi}{3}) \quad (5)$$

Figure 2 shows the ISRF based series APF controller for a single phase (for example phase-a). In d-q transform process of controller method as shown, phase voltage and its symmetric reference signals are firstly transformed to  $\alpha$  and  $\beta$  components for single phase:

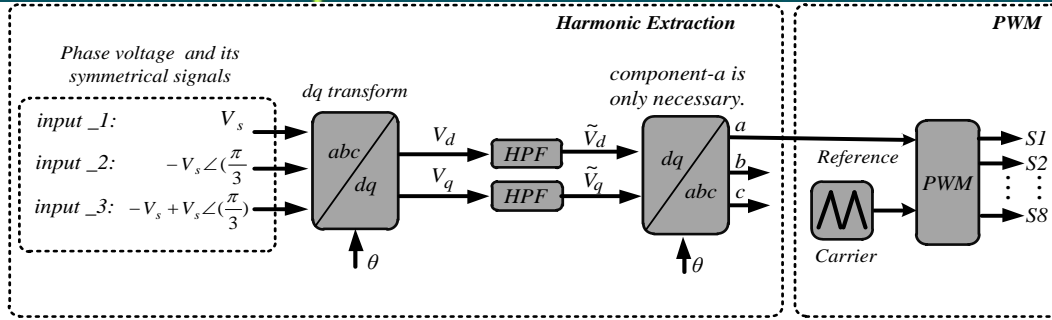

Figure 2. Improved SRF based controller to extract voltage harmonics for a single phase system

$$\begin{bmatrix} V_\alpha \\ V_\beta \end{bmatrix} = \sqrt{\frac{2}{3}} \begin{bmatrix} 1 & -\frac{1}{2} & -\frac{1}{2} \\ 0 & \frac{\sqrt{3}}{2} & -\frac{\sqrt{3}}{2} \end{bmatrix} \begin{bmatrix} V_s \\ -V_s \angle(\pi/3) \\ -V_s + V_s \angle(\pi/3) \end{bmatrix} \quad (6)$$

Then,  $\alpha$ - $\beta$  to dq transform is realized in (7).

$$\begin{bmatrix} V_d \\ V_q \end{bmatrix} = \begin{bmatrix} \cos(\omega t) & \sin(\omega t) \\ -\sin(\omega t) & \cos(\omega t) \end{bmatrix} \begin{bmatrix} V_\alpha \\ V_\beta \end{bmatrix} \quad (7)$$

In harmonic reference signal generation, high pass filter is used to extract the harmonic components in dq coordinates. As a result of this process, the harmonic components are separated from fundamental component. Then, these signals are applied again to dq-abc, and harmonics reference signals are generated for each phase.

$V_d$  and  $V_q$  consist of fundamental and harmonic components[16]. Harmonics components behave as AC components while the fundamental component is in DC form. AC and DC components in dq frame are defined in (8).

$$\begin{bmatrix} V_d \\ V_q \end{bmatrix} = \begin{bmatrix} \bar{V}_d + \tilde{V}_d \\ \bar{V}_q + \tilde{V}_q \end{bmatrix} \quad (8)$$

Where  $\bar{V}_d$  and  $\bar{V}_q$  are dc components,  $\tilde{V}_d$  and  $\tilde{V}_q$  are AC components.  $\tilde{V}_d$  and  $\tilde{V}_q$  are separated from  $V_d$  and  $V_q$  using high pass filter. After that,  $\tilde{V}_d$  and  $\tilde{V}_q$  are converted to  $\alpha$ - $\beta$  components expressed in (9).

$$\begin{bmatrix} \tilde{V}_\alpha \\ \tilde{V}_\beta \end{bmatrix} = \begin{bmatrix} \cos(\omega t) & -\sin(\omega t) \\ \sin(\omega t) & \cos(\omega t) \end{bmatrix} \begin{bmatrix} \tilde{V}_d \\ \tilde{V}_q \end{bmatrix} \quad (9)$$

To generate single phase reference signal of harmonic voltage, only component-a is necessary in inverse dq transform.

$$V_{harmonics} = \sqrt{\frac{2}{3}} \tilde{V}_\alpha \quad (10)$$

### 3.PERFORMANCE RESULTS

In this section, the performance results of ISRF controlled single phase Series APF are presented. The system specifications of simulation model are 690V<sub>LL</sub> grid voltage and 50 kVA nonlinear load with THD<sub>v</sub>=13.14%. The study is proposed to compensate up to voltage harmonics with 15% THD. The controller algorithm and system configuration is performed by using PSCAD/EMTDC program.

In case study, the compensation of single phase voltage harmonics is analyzed in the system. Figure3 illustrates the voltage waveforms of load, APF and grid voltages. THD value at load-side voltage is equal to 13.14%. When APF is in operation, it compensates voltage harmonics at source-side. As shown in Figure 4, THD level is reduced from 13.14% to 2.37% which satisfies IEEE 1159-2009 requirements.

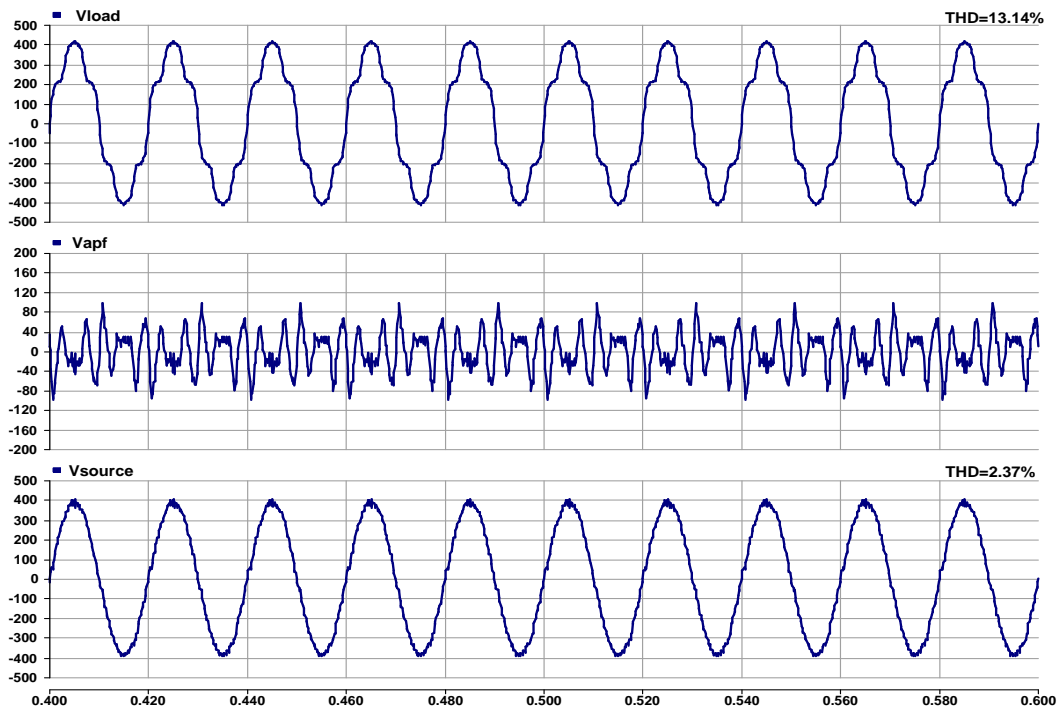

Figure 3. The voltage waveforms for case study

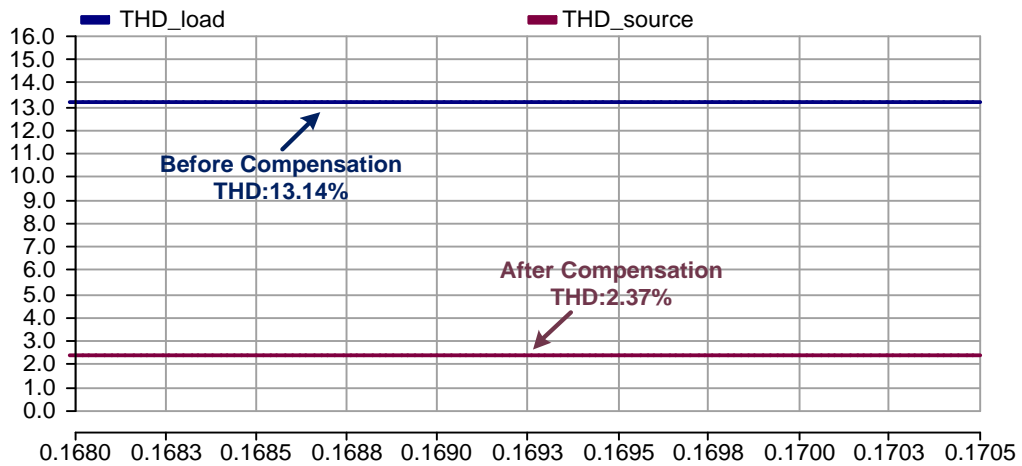

Figure 4. THD values (%) before/after compensation

## 4. CONCLUSION

In this paper, SRF technique is improved to extract harmonics signals in single phase active power filters. Traditional SRF Theory is the most widespread harmonics extraction method in three phase systems. The main drawback of traditional SRF is not applicable for single phase systems. To eliminate the drawback of traditional SRF, this study proposes improved SRF (ISRF) to extract voltage harmonics in both single and unbalanced three phase systems. The proposed method is tested in series APF to compensate the voltage harmonics at load voltage. THD level is reduced to 2.37 from 13.14 which is fairly lower explained in IEEE 1159-2009 standards. The performance results verify the efficacy and accuracy of proposed controller by using PSCAD/EMTDC.

## REFERENCES

- [1] M. Kiani and W. J. Lee, "Effects of voltage unbalance and system harmonics on the performance of doubly fed induction wind generators," IEEE Trans. Ind. Appl., vol. 46, no. 2, pp. 562–568, 2010.

- [2] M. Shareghi, B. T. Phung, M. S. Naderi, T. R. Blackburn, and E. Ambikairajah, "Effects of current and voltage harmonics on distribution transformer losses," *Proc. 2012 IEEE Int. Conf. Cond. Monit. Diagnosis*, C. 2012, no. September, pp. 633–636, 2012.
- [3] W. Wu, Y. Sun, M. Huang, X. Wang, H. Wang, F. Blaabjerg, M. Liserre, and H. S. H. Chung, "A robust passive damping method for LLCL-filter-based grid-tied inverters to minimize the effect of grid harmonic voltages," *IEEE Trans. Power Electron.*, vol. 29, no. 7, pp. 3279–3289, 2014.
- [4] G. A. D. A. Carlos and C. B. Jacobina, "Series Compensator Based on Cascaded Transformers Coupled with Three-Phase Bridge Converters," in *Energy Conversion Congress and Exposition (ECCE)*, 2015 IEEE, 2015, pp. 3414–3421.
- [5] A. Reinhold and H. Leipzig, "AC- and DC-Power Quality improvement of diode rectifiers due to parallel-series active filtering The proposed active power filter," in *PCIM Europe 2015; International Exhibition and Conference for Power Electronics, Intelligent Motion, Renewable Energy and Energy Management; Proceedings of*, 2015, no. May, pp. 19–21.
- [6] M. T. Associate, E. Engineering, and S. Sai, "Modeling and Simulation of Various Srf Methods for Shunt Active Power Filter and Application To," *Int. J. Adv. Eng. Res. Stud.*, vol. 1, no. 4, pp. 18–22, 2012.
- [7] S. A. O. Da Silva and R. A. Modesto, "A comparative analysis of SRF-based controllers applied to active power line conditioners," in *Proceedings - 34th Annual Conference of the IEEE Industrial Electronics Society, IECON 2008*, 2008, pp. 405–410.
- [8] J. Modarresi, M. Fallah, and E. Gholipour, "Improving the SRF method to compensate low-order harmonics under nonsinusoidal network voltages," pp. 1–15, 2013.
- [9] S. R. Prusty, S. K. Ram, B. D. Subudhi, and K. K. Mahapatra, "Performance analysis of adaptive band hysteresis current controller for shunt active power filter," in *2011 International Conference on Emerging Trends in Electrical and Computer Technology*, 2011, pp. 425–429.
- [10] J. Vijayasree, B. Vijayakrishna, and Y. R. Babu, "Implementation of SRF based Multilevel Shunt Active Filter for Harmonic Control," *Int. J. Eng. Res. Dev.*, vol. 3, no. 8, pp. 16–20, 2012.
- [11] M. S. Hamad, M. I. Masoud, and B. W. Williams, "Medium-voltage 12-pulse converter: Output voltage harmonic compensation using a series APF," *IEEE Trans. Ind. Electron.*, vol. 61, no. 1, pp. 43–52, 2014.
- [12] S. P. Litrán and P. Salmerón, "Analysis and design of different control strategies of hybrid active power filter based on the state model," *IET Power Electron.*, vol. 5, no. 8, p. 1341, 2012.
- [13] J. Tian, Q. Chen, and B. Xie, "Series hybrid active power filter based on controllable harmonic impedance," *IET Power Electron.*, vol. 5, no. 1, pp. 142–148, 2012.
- [14] A. Varschavsky, J. Dixon, M. Rotella, and L. Moran, "Cascaded nine-level inverter for hybrid-series active power filter, using industrial controller," *IEEE Trans. Ind. Electron.*, vol. 57, no. 8, pp. 2761–2767, 2010.
- [15] W. Jianwei, H. Xiaoguang, and C. Songsong, "Research on detection algorithm of voltage sag characteristics," in *7th IEEE Conference on Industrial Electronics and Applications (ICIEA)*, 2012, pp. 313–318.
- [16] L. B. G. Campanhol, A. Goedel, S. A. O. Silva, and C. F. Nascimento, "Neural-Networks and Synchronous Reference Frame Applied in the Harmonic Compensation with a Three-Phase Parallel Active Power Filter," in *International Conference on Renewable Energies and Power Quality (ICREPQ'12)*, 2012, pp. 1–6.

# Field Calibration Of Neutron Moisture Meter For Measuring Soil Water Content In Loamy Soils

Halil Kırnak<sup>1</sup>, Yasemin Akpınar<sup>1</sup>, Ali Unlukara<sup>1</sup>, Hasan Ali Irik<sup>1</sup>

---

## Abstract

Increasing of water-use efficiency in agriculture requires a precise measurement of soil water content in root zone. Soil moisture sensors provide a great opportunity to achieve efficiency improvements. In this study, a performance evaluation of a single neutron moisture meter's calibration equation in loamy soil was studied for varying soil moisture and different soil depth conditions under field conditions in Turkey. Measured soil water content values were compared with corresponding values derived from gravimetric samples. Experimental data were collected in a drip irrigated pumpkin (*Cucurbita pepo* L.) field in 2015. The accuracy of neutron moisture meter would change based on soil depth. The measurements in 20 cm soil depth gave the worst regression coefficient ( $R^2 = 0.85$ ) while RMSE value of measurements in 100 cm soil depth was lower. The *t* statistic between predicted values obtained from soil moisture sensing device and observed values obtained from gravimetric procedures at  $p < 0.05$  level was insignificant for all depths. Results showed that the neutron probe technique with a single calibration equation in loamy soil could be used under varying soil moisture conditions.

**Keywords:** Neutron moisture meter, soil moisture, calibration, performance

---

## 1. INTRODUCTION

Water resources are the critical component of sustainable agricultural development policies. Significance of limited resources is ever-increasing together with current climate change and global warming concerns especially in dry climates. Agricultural sector is in a great competition with domestic and industrial sectors in water demands. Such a competition for limited water resources enforces freshwater users to use water efficiently. Agriculture is the largest water consuming sector (around 74%) in Turkey as it was in all around the world. Soil moisture measurement is vital for assessing the effect of irrigation management on agricultural crops. A precise determination of soil moisture in the root zone is crucial for sustainable agriculture since it directly affects irrigation scheduling, protection and management of soil-water sources as well as protecting environment. Therefore, new technologies over the measurement of soil moisture should be appreciated.

A variety of methods are available for determining soil moisture content. In general, soil moisture content can be measured either destructive (gravimetric, direct) or non-destructive methods (soil moisture sensors, indirect). Today, there are many soil moisture sensors available such as neutron probe, TDR, FDR, porous blocks, tensiometers. In irrigation scheduling studies, use of gravimetric methods are mostly defined as time consuming and labour intensive [1]. Accuracy, simplicity, laborintensity, possible health hazard and cost are the main factors at the selection of the soil moisture sensors [2].

The neutron moisture meter (neutron probe technology) consists of a source of fast, high energy neutrons and slow (thermal) neutron detector under the soil surface and an electron counting system connected by an electronic cable at the upper soil surface (Figure 1). The fast moving neutrons are released into the soil from the radioactive source and the neutrons are slowed down by hydrogen atoms present in the water molecules in the soil. Then, slow neutrons are counted by an electronic counting scale. The neutron probe technology requires a trained operator because of radioactive source and its potential hazardous to human health. With this equipment, soil moisture can be estimated as a volumetric in the desired depth in the soil [3],[4].

Reference [4] indicated that the calibration of the neutron moisture meter should be done using dry/wet site method and details of this procedure were given in [5], [6]. Reference [5] calibrated the neutron moisture meter for six soil types in Uzbekistan and concluded that the calibration equation could change based on soil texture and depth. The objective of this study was to test accuracy of the neutron moisture meter's calibration equation developed by both dry and wet sites in loamy soil at varying soil moisture and depths under drip irrigated pumpkin field.

---

<sup>1</sup>Corresponding author: Erciyes University, Department of Biosystems Engineering, 38038, Melikgazi/Kayseri, Turkey. [hkirnak@yahoo.com](mailto:hkirnak@yahoo.com)

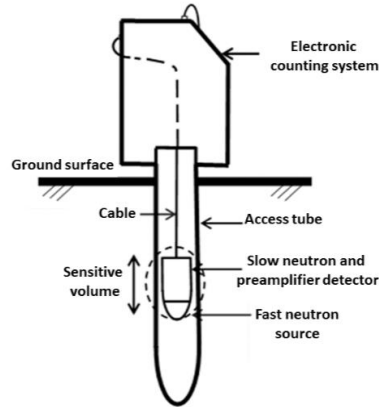

Figure 1. The schematic drawing of a neutron moisture meter

## 2.MATERIALS AND METHODS

Experiments were conducted in the years of 2015 at the Agriculture Research Station of University of Erciyes, Kayseri, Turkey (1094 m, 38° 18' N and 34° 56' E) under drip irrigated pumpkin field. Irrigation water was supplied from a deep well with quality classified C<sub>1</sub>S<sub>1</sub>, and pH and EC values of irrigation water was 7.60 and 0.242 dS m<sup>-1</sup> respectively. The study site had 6 different irrigation treatments starting from dry to full irrigation. Amount of water applied to treatments were increased from treatment 1 to treatment 6. The treatment 1 shows the dry condition while the treatment 6 shows the full irrigation. Irrigation was initiated on 19th of June in 2015 and stopped on 6th of August. The test was repeated under different soil moisture levels with drip irrigated pumpkin on varying dates. The soil properties of the site were given in Table 1. The used neutron probe in the experiment was CPN 503 DR Hydroprobe (Figure 2).

The calibration of the neutron moisture meter was performed using methods described in [4],[5]. To do so, a PVC access tube in both dry and wet sites in the experimental field in late September of 2014 were installed to 1.2 m depth. The wet site with mulches was allowed to drain to field capacity of the soil (i.e., approximately three days) before reading. Standard counts were taken until reaching  $\chi^2$  (ki-square) values between 0.95 and 1.05 with the neutron moisture meter mounted at 85 cm above the soil surface on a depth control stand described in [6]. The neutron probe was in its shield while taking standard counts. The device gave the count ratio (CR) automatically by dividing each access tube count to the mean of the standard counts. After readings CR from each access tubes, a four volumetric soil samples at the around of each depth were taken using 100-cm<sup>3</sup> sampling cylinders. A calibration equation was then calculated using a linear regression of the CR vs. gravimetric base volumetric water content. The obtained calibration equation was  $P_v = 29 \times CR - 8.3$  and then this estimated volumetric moisture content by the neuron moisture meter was compared with gravimetric moisture under varying moisture conditions in the field.

In each irrigation treatment the access tube was installed roughly 0.10 m apart from the dripper of the lateral. Data collection began in the late June and continued till beginning of August. In order to avoid damaging soil around the access tube, the gravimetric samples had to be always taken from different locations but at the same positions of access tubes in the same parcel using a soil auger method. After each sensor reading, soil gravimetric samples were taken at the same time. The sensor measurements were made at five different soil depths (20, 40, 60, 80 and 100 cm) under different irrigation regimes. A calibration equation for each soil depths was obtained.



Figure 2. Measurements of soil moisture by a neutron probe under different dates



Table 1. Soil properties of study site

Depth (cm)	Texture	pH	EC (mmhos cm <sup>-1</sup> )	FC <sub>w</sub> (%)	PWP <sub>w</sub> (%)	Organic matter (%)	Bulk density (g cm <sup>-3</sup> )
0-20	Loam	8.13	0.226	23.2	9.2	0.98	1.27
20-40	Loam	8.17	0.214	25.8	10.2	1.25	1.28
40-60	Loam	8.18	0.173	26.4	11.3	1.05	1.24
60-80	Clay-Loam	8.14	0.258	26.2	9.3	0.69	1.22
80-100	Loam	8.23	0.191	25.6	9.4	0.73	1.28

The standard procedures was applied over the gravimetric samples to determine the gravimetric soil moisture content. In order to convert the gravimetric soil moisture into volumetric soil moisture content (VWC), the soil bulk density was considered. During the times of gravimetric sampling, soil temperatures ranged from 22-35°C in dry treatment, 23-28°C in treatment 1, 22-30°C in treatment 2, 22-28°C in treatment 3, 21-68°C in treatment 4 and 22-25°C in treatment 5.

The statistical parameters were used to compare predicted (Pi) data from the neutron probe measurements with the observed (Oi) gravimetric samples (n). The statistical measures were the coefficient of determination (R<sup>2</sup>) and root mean square error (RMSE) as defined by [7]. Paired-sample t test was also applied to present statistical significance of differences between neutron probe measured VWC and actual VWC determined by gravimetric process.

$$RMSE = [n^{-1} \sum_{i=1}^n (P_i - O_i)^2]^{0.5} \tag{1}$$

### 3.RESULTS AND DISCUSSION

The statistical analysis showed that soil moisture values from neutron probe (Neutron<sub>20cm</sub>, Neutron<sub>40cm</sub>, Neutron<sub>60cm</sub>, Neutron<sub>80cm</sub> and Neutron<sub>100cm</sub>) and corresponding gravimetric soil moisture contents at the same soil depths were close to each other. The paired-sample t test indicated that the difference between neutron probe and gravimetric method at different soil depths was insignificant at p< 0.05 level. The changes of VWC obtained from gravimetric method and neutron probe are given in Figure 3. When the R<sup>2</sup> values in Figure 3 were analyzed, it could be realized that R<sup>2</sup> values obtained from top (20 cm) and deep (100 cm) soil horizons were lower than middle soil horizons (40-60 cm). This obviously shows that the performance and accuracy of the neutron probe can vary based on soil depths. This also agrees with the findings of [5].The changes of VWC obtained from gravimetric method and neutron probe are given in Fig. 4. The Fig. 4 shows a very close relationship in VWC between the neutron probe technique and gravimetric method.

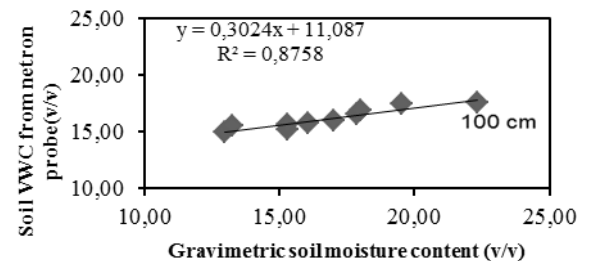
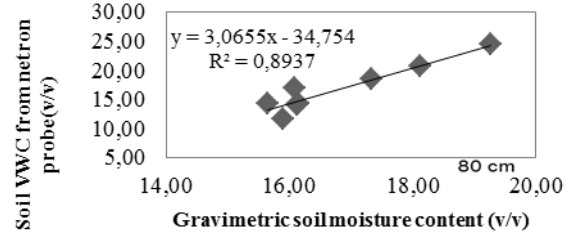
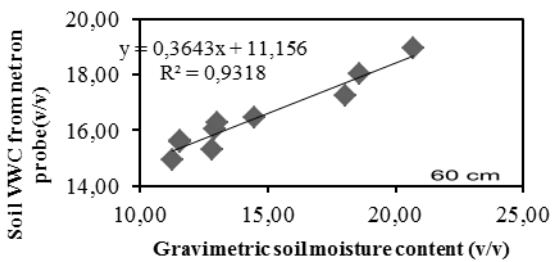
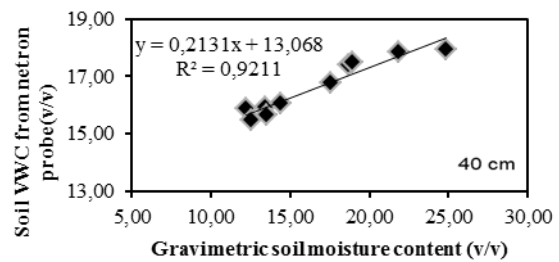
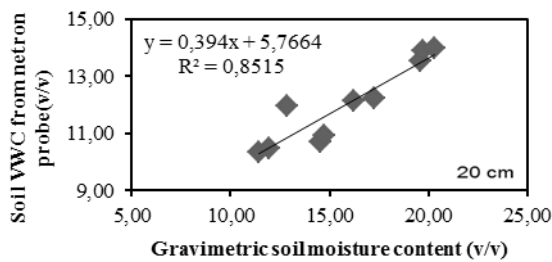
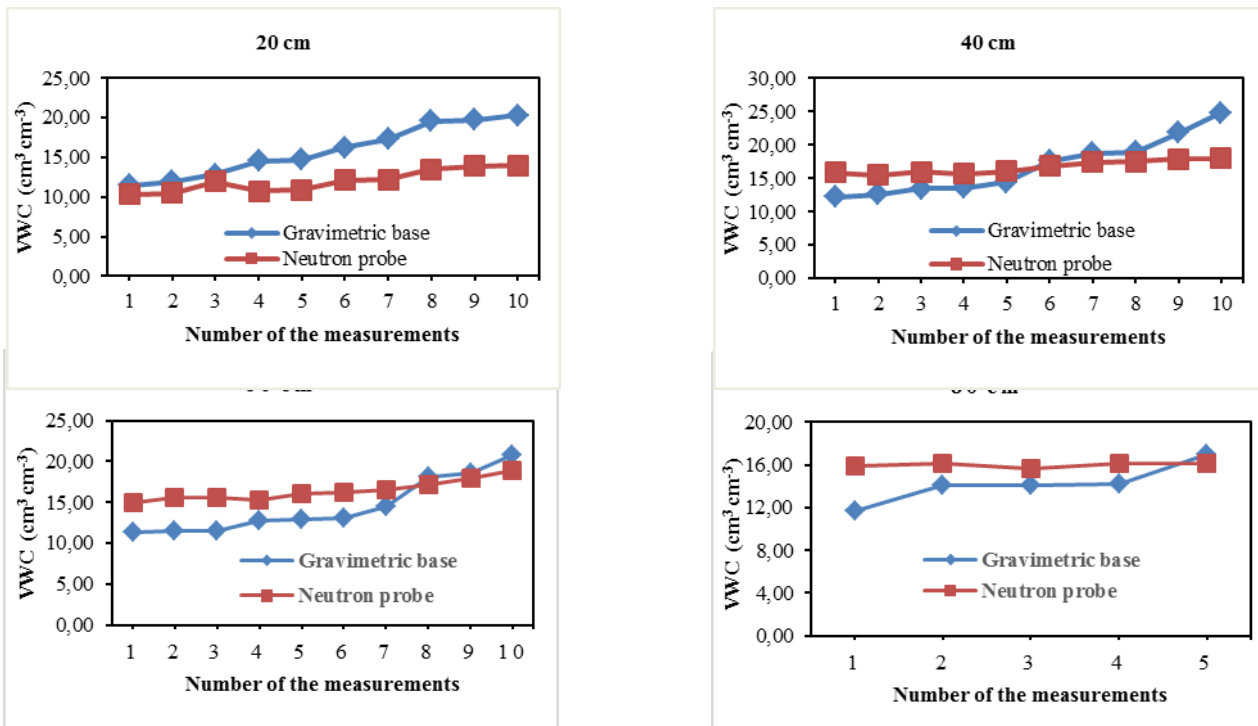

Figure 3. Comparison of measured VWC from the gravimetric procedure versus neutron probe

The RMSE values at the different soil depths are given in Table 2. The calculated RMSE values were between 2.0 and 4.32 based on soil depths. The worst RMSE value was obtained from top (20 cm) soil. Reference [5] stated that the RMSE of the calibration equation ranged from 0.009 to 0.025 m<sup>3</sup> m<sup>-3</sup> and R<sup>2</sup> values were between 0.91 and 0.99 for soil types under different carbonate accumulation in Uzbekistan. Our experimental results were a little bit worse than reference [5] results. It could be due to locations of the gravimetric sampling and also characteristics of the soil studied. In our experiment, the gravimetric sampling was not taken near the access tube to avoid soil disturbance outside the access tube. Instead, the gravimetric soil samples were taken from different locations of the same parcel but away from the access tubes under similar soil moisture conditions.

Table 2. RMSE values for different soil depths

Depth	RMSE
Neutron-20cm	4.32
Neutron-40cm	3.23
Neutron-60cm	2.82
Neutron-80cm	2.80
Neutron-100cm	2.00



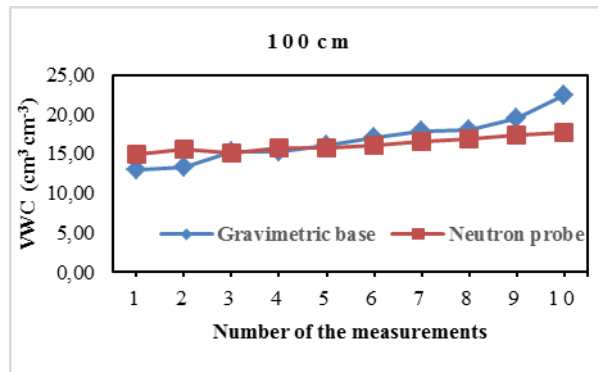

Figure 4. Changes of VWC obtained from gravimetric method and neutron probe

#### 4. CONCLUSIONS

The field results showed that neutron moisture meter's calibration equations developed according to [4], [6] in loamy soil could be securely used under different irrigation regimes at varying soil depths. The t-test between neutron probe technique and gravimetric method showed that there was no statistical difference at  $p < 0.05$  level. The regression coefficient was between 0.85-0.93 based on soil depths. However, more studies should be done under different soil type and soil-water management conditions. The neutron probe technique with calibration equations obtained with wet/dry site technique could be used under different soil moisture conditions in loamy soil.

#### ACKNOWLEDGMENT

The authors would like to thank the Turkish Scientific and Technical Research Council (TUBITAK) and University of Erciyes for financial support to the project of TOVAG-114 O 225 and BAP FYL-2015-5878, respectively.

#### REFERENCES

- H. Kırnak and Y. Akpınar, "Performance Evaluation of TDR Soil Moisture Sensor", *Agronomy Research* 14 (2), 428-433, 2016.
- B.G. Leib, D. Joy, and G.R. Mattheurs, "Field Evaluation and Performance Comparison of Soil Moisture Sensors", *Soil Science*, 168(6):396-408, 2013.
- S. Fityus, T. Wells, and W. Huang, "Water Content Measurement in Expansive Soils Using The Neutron Probe", *Geotechnical Testing Journal*, 34(3), 1-10, 2011.
- S.R. Evett, "Soil water measurement by neutron thermalization" *Encyclopedia of Water Science*, 889-893, Marcel Dekker Inc., NY, 2003.
- S. Evett, N. Ibragimov, B. Kamilov, Y. Esanbekov, M. Sarimsakov, J. Shadmanov, R. Mirhashimov, R. Musaev, T. Radjabov and B. Muhammadiev, "Neutron moisture meter calibration in six soils of Uzbekistan affected by carbonate accumulation" *Vadose Zone Journal*, 6:406-412, 2007.
- S. Evett, *Soil Water and Monitoring Technology*, In: Laskano R.J., Sojka R.R (Eds), Irrigation of Agricultural Crops. American Society of Agronomy, Madison, 2007.
- J.L. Chaves, J.L. Varble, and A.A. Andales, "Performances evaluation of selected soil moisture sensors". In: *Proceedings of the 23<sup>rd</sup> annual central plains irrigation conference*. Kansas, USA, 29-37, 2011.

# Evaluation of Accounting Education Offered in Formal Education in Turkey in Terms of Infrastructure and Human Standards -A Model Practice in Erzurum-

*Resat Karcioğlu<sup>1</sup>, Sakir Dızman<sup>1</sup>, Abdulkadir Kaya<sup>1</sup>*

---

## *Abstract*

*With the new Turkish Trade Act, which was introduced in 2011 in Turkey, organisation of accounting records and financial statements must be based on the International Accounting and Financial Reporting Standards. These standards are constituted and accepted on a global scale. In order to practice standards and make it the foundation for desired right evaluations, it is very important to organise accounting records and financial statements according to these standards. Ensuring compliance with standards on a global scale will allow comparable and objective accounting records and financial data to be created in the world. As a result, it will be possible to base financial and economical evaluations on right foundations. Schools' physical infrastructure, students' educational infrastructure and competency of human factors that provide and support accounting education is critically important in order to be able to provide education in compliance with these standards. In this study, we tried to determine how students, who receive accounting education in Turkey's formal education institutions, receive this education in terms of educational infrastructure and competency in humane standards by conducting a survey. With the pilot application in Erzurum city, how the competency in terms of infrastructure of accounting education and human standards is perceived in all formal education levels by people who receive this education. The survey was conducted among students who received accounting courses in high school, college, faculty, master's and doctoral level. Thus, perceptions of students, who have received accounting course in every level of formal accounting education, educational infrastructure and physical infrastructure and competency in terms of human standards were measured.*

**Key Words:** *Accounting, Financial Statements, Accounting Education, IAS, IFRS.*

---

## 1. INTRODUCTION

With the introduction of new Turkish Trade Act in 2011, compliance with the International Accounting and Financial Reporting Standards became compulsory in accounting records and organising financial statements. Compliance with these standards will allow accounting records and financial data to be more comparable and lead to more accurate evaluations at a national and global level. Ensuring compliance with these standards, educational infrastructure, the physical infrastructures of institutions where accounting education is offered, and standards of human factors which affect the accounting education offered directly and indirectly, are important. Students' educational infrastructure in the beginning of the accounting education, the suitability of accounting content to the level of education of students, efficiency of physical infrastructure of the educational institution and more importantly, competency of human factors that have direct and indirect effects on accounting education offered are important.

Achieving a high level of success in an education system depends on using several factors together and accurately. Use of all factors that produce success in education will increase the overall quality. It is the same for accounting education.

For the success of accounting education, it is important to create course content in compliance with these standards, students' infrastructures in the beginning of education and the physical infrastructure of education institutions in addition to other factors. The quality and efficiency of educators, administrators and other support staff in providing services have important effects on the quality of education. For these reasons, previous education background of students who are receiving accounting education and physical infrastructure of institutions where accounting education is offered, competency of educators and other personnel and their performance in providing services have a high impact on the quality of accounting education.

## 2. APPLICATION OF INTERNATIONAL ACCOUNTING AND FINANCIAL REPORTING STANDARDS IN TURKEY

---

<sup>1</sup> Prof. Dr., Atatürk University, Faculty of Economic and Administrative Sciences, Department of Accounting and Finance, Erzurum, Turkey, [rkarci@atauni.edu.tr](mailto:rkarci@atauni.edu.tr) [sakir.dizman@erzurum.edu.tr](mailto:sakir.dizman@erzurum.edu.tr)

With the introduction of new Turkish Trade Act in 2011, compliance with the International Accounting and Financial Reporting Standards became compulsory in accounting records and organising financial statements (TTA, article 64, 68, 69, and 1534). These standards are the International Accounting and Financial Reporting Standards. These standards were translated into Turkish and are accepted as Turkish Accounting Standards and Turkish Financial Reporting Standards (Akdogan, Sevilengul, 2007, 31). International accounting and financial reporting standards published within this context are translated into Turkish and published as national standards and application of these standards are obligatory since 2013. Accounting education at the high school and associate degree level are conducted within the scope of "Vocational and Technical Training Regulations" and the other legislation regarding education ([www.tesk.org.tr](http://www.tesk.org.tr)). Accounting education at the undergraduate and graduate level is conducted within the scope of the other legislation of Higher Education and the regulations of associate, undergraduate and graduate education (Dizman, 2015, 16). Accounting education is generally offered in high school, associate, undergraduate and graduate institutions specified in the Law number 1739, Article 36. Education offered in regards to accounting standards will improve accounting applications (Yukcu et al., 1997, 20).

### **3. STUDENTS' EDUCATIONAL BACKGROUND IN THE BEGINNING OF ACCOUNTING TRAINING**

The starting point of the accounting training in formal education in Turkey is the education offered in vocational high schools and high schools with multiple programs that are specified in the article 29 in the law number 1739. Previous education level of students is important for the success of accounting training because when the accounting training is given to students with strong background, the efficiency reaches to a higher level. Therefore, students' previous education background will impact the quality of education.

### **4. PHYSICAL INFRASTRUCTURE OF INSTITUTIONS WHERE ACCOUNTING TRAINING IS PROVIDED**

Schools and places in these schools where accounting training is provided have impact on the quality of education. Physical characteristics and equipment of these places impact the quality of education. Classrooms and other units where education is provided (labs etc.) need to be designed accordingly with structure and student capacity. The number of students should be appropriate and the physical capacity needs to be adjusted according to the number of students.

### **5. HUMAN STANDARDS IN ACCOUNTING EDUCATION**

As in education in general, in accounting education both students receiving the education, educators who are providing it, administrators and other support personnel need to have certain standards.

These standards are the education that students received previously to gain competency in order to be able to receive accounting training. In other words, students need to receive formal education previously and this education needs to have certain standards in order for the student to receive accounting training.

Educators need to have the formation, education background and up-to-date-information to offer the accounting education accurately. Educators need to be competent enough to provide accounting training by using the most accurate methods, techniques and technologies.

Administrators and other support personnel need to be supportive for the accounting training to be provided under the most suitable conditions. Administrators have the highest responsibility to create the infrastructure needed for training to be offered in suitable conditions. Administrators who undertake these responsibilities successfully in terms of physical infrastructure and equipment increase the quality of accounting education.

Technical and other support personnel have an impact on the increase of the quality of accounting training by supportive works they do. For instance, in computerized accounting classes, having computers ready for class in terms of equipment and software, providing cleaning services on a timely and accurate manner.

### **6. A MODEL PRACTICE IN THE CITY OF ERZURUM WHICH COVERS ALL STAGES OF FORMAL ACCOUNTING EDUCATION**

#### **6.1. Research Objective**

The research objective is to determine the competency of previous education background of students who had taken accounting courses, the competency of the infrastructure of schools where accounting training is provided, the competency of accounting instructors, administrators and other support personnel, and to provide solutions.

#### **6.2. The Scope of Research**

The research is a survey application for students who have taken accounting courses in 2 Trade Vocational Schools, 2 Colleges, Faculty of Economics and Administrative Sciences of 2 universities and in master's and doctoral programs of a university in Erzurum.

#### **6.3. Methodology of the Research**

In this research, students were asked 10 survey questions about education background, school infrastructure, competencies of educators and other personnel. They were asked to answer these questions in a 5 point Likert scale.

## 6.4. Results of Survey Evaluations

Students were asked to answer 10 questions in 5 point Likert scale. Answer options for the questions and the percentages of answers (%) are provided below.

1 Strongly Agree 2 Agree 3 Neutral 4 Disagree 5 Strongly Disagree

Infrastructure of Accounting Education and Human Standards Survey Results (%)

Table 1. Physical environments where accounting training is done are appropriate for this training. (%)

Options	1	2	3	4	5	Total
High Schools	17	35	34	10	4	100
Colleges	14	31	32	14	9	100
Faculties	10	32	29	19	10	100
Master	10	30	40	20	0	100
Doctorate	0	10	40	40	10	100
Total	51	138	165	103	33	500
Average %	10	28	33	21	8	100

Table 2. The number of students per classrooms where accounting training is done is appropriate for this training. (%)

Options	1	2	3	4	5	Total
High Schools	19	40	26	13	2	100
Colleges	6	39	33	14	8	100
Faculties	9	35	25	20	11	100
Master	10	20	20	40	10	100
Doctorate	10	20	20	40	10	100
Total	54	154	124	127	41	500
Average %	11	31	25	25	8	100

Table 3. Formal education we receive before accounting training is sufficient to understand accounting classes. (%)

Options	1	2	3	4	5	Total
High Schools	17	42	30	9	2	100
Colleges	18	27	33	17	5	100
Faculties	6	28	29	23	14	100
Master	0	30	40	20	10	100
Doctorate	0	40	0	30	30	100
Total	41	167	132	99	61	500
Average %	8	33	27	20	12	100

Table 4. The content of accounting classes provided are appropriate to my education level. (%)

Options	1	2	3	4	5	Total
High Schools	23	43	23	6	5	100
Colleges	6	37	37	14	6	100
Faculties	8	33	29	22	8	100
Master	10	40	20	20	10	100
Doctorate	10	40	20	20	10	100
Total	57	193	129	82	39	500
Average %	11	39	26	16	8	100

Table 5. Accounting training is done in accordance with methods and techniques that make learning easier. (%)

Options	1	2	3	4	5	Total
High Schools	19	36	31	9	5	100
Colleges	9	34	37	13	7	100
Faculties	7	27	31	22	13	100
Master	0	20	20	40	20	100
Doctorate	10	30	10	30	20	100
Total	45	147	129	114	65	500
Average %	9	29	26	23	13	100

Table 6. The accounting knowledge of accounting instructors is sufficient. (%)

Options	1	2	3	4	5	Total
High Schools	18	36	29	12	5	100
Colleges	11	35	31	16	7	100
Faculties	9	36	27	18	10	100
Master	10	40	10	30	10	100
Doctorate	0	20	40	30	10	100
Total	48	167	137	106	42	500
Average %	10	33	27	21	9	100

Table 7. Teaching of accounting instructors is understandable and effective. (%)

Options	1	2	3	4	5	Total
High Schools	21	38	29	8	4	100
Colleges	5	37	37	15	6	100
Faculties	10	32	28	17	13	100
Master	0	20	30	30	20	100
Doctorate	0	30	10	40	20	100
Total	36	157	134	110	63	500
Average %	7	31	27	22	13	100

Table 8. Our administrators have the necessary elements ready on a timely manner and at a sufficient level. (%)

Options	1	2	3	4	5	Total
High Schools	21	37	25	12	5	100
Colleges	9	26	39	17	9	100
Faculties	7	27	31	24	11	100
Master	10	40	20	20	10	100
Doctorate	10	20	20	30	20	100
Total	57	150	135	103	55	500
Average %	11	30	27	21	11	100

Table 9. Technical personnel keep necessary equipment for accounting training ready in a timely manner consistently. (%)

Options	1	2	3	4	5	Total
High Schools	25	35	28	9	3	100
Colleges	5	37	31	19	8	100
Faculties	7	32	31	18	12	100
Master	0	30	20	40	10	100
Doctorate	0	10	20	30	40	100
Total	37	144	130	116	73	500
Average %	7	29	26	23	15	100

Table 10. Other personnel (officers, attendant, etc) do the necessary work consistently and at a sufficient level in order for the accounting training to be provided under appropriate conditions.

Options	1	2	3	4	5	Total
High Schools	24	31	27	10	8	100
Colleges	5	30	38	18	9	100
Faculties	6	30	33	21	10	100
Master	10	10	30	30	20	100
Doctorate	10	10	40	30	10	100
Total	55	111	168	109	57	500
Average %	11	22	34	22	11	100

Table 11. All Schools (%)

Options	1	2	3	4	5	Total
High Schools	21	37	27	10	5	100
Colleges	9	33	35	16	7	100
Faculties	8	31	30	20	11	100
Master	6	28	25	29	12	100
Doctorate	5	23	22	32	18	100
Total	49	152	139	107	53	500
Average %	10	30	28	21	11	100

Survey questions in high schools were accepted at a high level. In terms of all the survey questions, “strongly agree” suggestion received the highest support in high schools with 21%. Again, the support for “Agree” suggestion occurred the most in high schools with 37%. The support ratio to survey suggestions in colleges is lower than high schools. The support ratio to suggestions in faculties is lower than colleges. Master’s and Doctoral education show the same decrease. The higher the level of accounting education, the lower the support ratio in survey suggestions. This shows that as the education level of students who receive this education goes higher the ratio of their satisfaction decreases in accounting education in terms of infrastructure and human standards. As the level of infrastructure and human standards increase, they are seen as more incompetent by students. Generally the support average to the survey suggestions were evaluated with all schools together, “Strongly Agree” received 10% and “Agree” received 30% support. In other words, survey suggestions are supported by 40% of students. The percentage of neutrals is 28%. When this ratio is distributed based on the ratio supported by the suggestions, the support ratio is 55.5%. The percentage of students who answered the questions as “Strongly Disagree” is 11%. The ratio of “Disagree” is 21%. The ratio of the students who did not support the suggestions is a total of 32%. When neutrals are added based on the ratio of who did not support the suggestions, the ratio of students who did not support the suggestions is 44.5%. In other words, competencies in infrastructure and human standards included in the survey suggestions were supported by 55.5% of participants while found incompetent by 45.5%. The highest support rate was found in high schools while the lowest is in doctoral education. In other words, the satisfaction rate in universities decreases as the stage of education increases.

## 7. CONCLUSION

The results of this study which evaluated the accounting training in terms of infrastructure and human standards, showed that 55.5% of students who received accounting training find the education competent in terms of infrastructure and human standards while 45.5% find it incompetent. With these ratios, the ratio of students who supported the suggestions is 10% more than the ones who did not support, it should be seen as competent. The highest support for the survey suggestions came from high schools. In other words, students who find the accounting education positive in terms of infrastructure and human standards are high school students in a high ratio because when neutrals are distributed in proportion to the students who supported the suggestions, total support reaches to 79% in high schools. In other education stages, this ratio decreases. In college, faculty, master’s and doctoral stages the ratio tends to decrease respectively. The lowest ratio is in doctoral education. The total support ratio in this education level is 28%. When neutrals are distributed based on the support, the total support ratio goes up to 36%. This ratios shows that doctoral students find accounting education incompetent in terms of infrastructure and human standards.



**REFERENCES**

- [1] Akdoğan Nalan, Sevilengül Orhan. (2007), Turkey To Harmonize Accounting Standards Should Be Made Uniform Account Plan Changes, Mali Çözüm, Issue: 84.
- [2] Dızman Şakir. (2015), According to the Formal Education System Provided Efficiency Transformation in Turkey and Accounting within This Transformation Of re-be Configured, Ekin Publisher.
- [3] <http://www.tesk.org.tr/tr/mevzuat/mesleki.pdf>(25.01.2016).
- [4] National Education Basic Law, Law No. 1739, Date of 14.06.1973, Official Gazette Date: 24.06.1973, Issue: 14574.
- [5] Turkish Commercial Code, 11.03.2011, Ankara, Official Gazette, Number: 27846, law No.: 6102, Date: 13.01.2011.
- [6] Yükçü Süleyman, Baklacı Hasan ve Evrim Pınar. (1997), Accounting Standards Problems in Teaching and Solutions, XVI. Turkey Accounting Education Symposium.

**BIOGRAPHY***Resat Karcioğlu*

He was born in Erzurum province, Turkey, and graduated from the Atatürk University in 1985, and got master degree and doctor degree in 1987 and 1990, in the Atatürk University. Now, he works as professor doctor in the Faculty of Atatürk University, Faculty of Economic and Administrative Sciences, Department of Accounting and Finance. His primary research interests include accounting and finance.

*Sakir Dızman*

He was born in Erzurum province, Turkey, and graduated from the Atatürk University in 1994, and got master degree and doctor degree in 1997 and 2008, in the Atatürk University. Now, he works as assistant professor doctor in the Faculty of Erzurum Technical University, Faculty of Economic and Administrative Sciences, Department of Administrative. His primary research interests include accounting and finance.

*Abdulkadir Kaya*

He was born in Erzurum province, Turkey, and graduated from the Atatürk University in 1999, and got master degree and doctor degree in 2003 and 2011, in the Atatürk University. Now, he works as assistant professor doctor in the Faculty of Erzurum Technical University, Faculty of Economic and Administrative Sciences, Department of Administrative. His primary research interests include finance and accounting.

# Linking Urban Security and Regional Development: Operationalizing Security-Development Nexus within Regional Development Agencies

Ahmet Barbak<sup>1</sup>

---

## Abstract

*This paper aims to present a conceptual framework for incorporating urban security concerns into regional development so as to operationalize security-development nexus within Regional Development Agencies (RDAs). The security issues pertinent to urbanization pose severe threats to individuals' and community's safety as a whole. Nevertheless, it seems that putting security into regional development agenda has been relatively ignored. Now that we have RDAs to promote development on a regional basis, security can be addressed as a part of regional development. In this study, it is argued that urban security can be embedded into RDA structure. Doing so, urban security can be placed within regional development practices as a functional and structural component. In this study, primarily, conceptual linkage between urban security and regional development is demonstrated. Then an Urban Security Ecosystem is defined in order to identify stakeholders of governance. Consequently, incorporating urban security into RDA relating it with Urban Security Ecosystem, it is suggested that security-development nexus can thus be operationalized. This study does not suggest a "one size fits all" model. However, a conceptual framework could be useful to further pertinent discussions and policy implementation.*

**Keywords:** Regional Development, Regional Development Agency, Security-Development Nexus, Urban Security.

---

## 1. INTRODUCTION

There has been a consensus within development community on linking security and development since 1990's (UNDP, 1994). This approach requires that both development and security policy making processes be merged to yield policy coherence. In this new understanding, providing security has been declared to be a precondition for reducing poverty and achieving the Millennium Development Goals adopted by United Nations (Denney, 2011; Boemcken, 2011).

Security-development nexus is based on the proposition that "*there can be no development without security and no security without development*" (Duffield, 2010; World Bank, 2011; Jackson, 2015). In other words, as Schnabel (2012) argues: "*(...) security-development nexus posits that there is an interaction between the security situation and development outcomes, between the development situation and security outcomes (...)*." As a result, security and development policies have been broadened to handle common issues in such a way that reinforces each other (Nikolaisen, 2011).

The security-development nexus *does not apply automatically across policy arenas or across levels of policy implementation* (global, national, local) and has no clear policy frameworks (International Peace Academy, 2004). Then the question should be, as Chandler (2007) asked: *What should be integrated with what?* It is obvious that conjoining security and development policymaking processes has both organizational and functional dimensions. Organizational dimension denotes merging security and development organizations focusing on coordination, coherence and cooperation between them. Accordingly, functional dimension necessitates performing security related functions within and between development organizations.

Urban security is one of the sub-themes of urbanization studies. It encompasses a wide range of concerns and issues related to urbanization ranging from basic needs, such as food, health and shelter, through protection from crime and the impacts of technological and natural hazards, to collective security needs, such as protection from urban terrorism (UN-Habitat, 2007). These threats have been observed to have arisen from rapid urban growth and the interaction of social, economic and institutional aspects of urban life, as well as environmental ones.

Urban security, as a multifaceted issue, has to do with various policy areas. According to Recasens *et al* (2013), "*to achieve reasonable implementation of these policies, it seems necessary seriously to rethink the structures and models of security at all levels*". In this study, as well, urban security is handled as a prospective component of regional development policy and organization. Emerged in the late 20<sup>th</sup> Century, recent regional development approach has been placed upon *re-scaling* the development process. Unlike nationwide central planning, regional development emphasized competitive advantage and governance structures encompassing a wide range of actors to stimulate development at regional basis. By freeing regions in motion, it has been aimed to enhance multi-level ecosystems structured to promote development and contribute national wellbeing.

---

<sup>1</sup>Corresponding author: İzmir Katip Celebi University, Department of Political Science and Public Administration, 35600, Çiğli/İstanbul, Turkey. [abarbak01@gmail.com](mailto:abarbak01@gmail.com)

In order to link urban security and regional development, that is, to incorporate urban security concerns into regional development one may search for entry points within existing structures. This study asserts that Regional Development Agencies (RDAs) constitute the appropriate structural entry point. But there has been no example in the literature as to how these two policy areas are to be converged within RDAs. Here, it is endeavored to constitute a conceptual framework/model to operationalize security-development nexus within RDAs. In order to integrate urban security concerns into regional development and operationalize security-development linkage, this paper aims at;

- Conceptualizing linkage between urban security and regional development,
- Defining urban security ecosystem in relation with RDA,
- Defining structural and functional components to be embedded within RDAs,
- Associating RDA to urban security ecosystem.

In this study, primarily, conceptual linkage between urban security and regional development is demonstrated. Then an Urban Security Ecosystem is defined in order to identify stakeholders of governance. Consequently, incorporating urban security into RDA relating it with Urban Security Ecosystem, it is suggested that security-development nexus can thus be operationalized. The study has no "one size fits all" approach. That is, here it is not endeavored to propose a uniform model for urban security-regional development nexus. Nevertheless, in order to structure this relationship so as to commence a policy debate and contribute to security-development nexus policy efforts, I argue that a pertinent conceptual framework is required as a starting point.

## 2. CONCEPTUAL FRAMEWORK

### 2.1. Urban Security

The world is moving to an age of intense urbanization with considerable growth in urban population. In this context, world's population is projected to be more than half urban by 2020 (UN-Habitat, 2007). Virtually uncontrollable, this phenomenon has implications for both peoples and their governments. Putting the urbanization issues on top of the international policy agenda, this phenomenon poses a serious challenge for present and future urban residents thus leading to urban based policymaking processes and paradigm shifts.

Increasing poverty, housing and employment needs and lacking adequate infrastructure and social services, such as healthcare and education, constitute the main causes of safety and security problems in urban areas (UN-Habitat, 2007). Therefore, urban security, macro-economic growth, scale and density of cities are regarded as the primary variables of the same equation. In some cases urban insecurity can be seen as an obstacle to macro-economic growth while in others, scale and density of cities and macro-economic growth pose a threat to urban security concurrently.

According to European Forum for Urban Security (EFUS), *European and national institutions now recognize cities as essential partners. Being the closest to the citizens, they combine competencies in solidarity, prevention and sanction with expertise in the management of everyday problems*" (European Forum for Urban Security, 2012: 2-4). Thus it is argued that security policies should be designed and constructed based on citizens' individual and collective needs with a participative approach rather than just focusing on public institutions'. We can conclude from abovementioned approach that urban security is not just of criminal case but of a larger societal and economic policy issue requiring organized efforts of public and private entities located in cities (Recasens *et al*, 2013; Gressgård, 2015).

Urban security refers to *the right to security in urban space, in relation with direct and indirect prevention of crime and violence* (European Forum for Urban Security, 2006). According to UN-Habitat (2007: 17-19), urban security has three dimensions, *crime and violence, tenure security and forced eviction, natural and human made disasters*. Taking policy measures against these challenges to urban security depend on sound policy making, adequate institutional capacity at both national and local government levels.

According to European Forum for Urban Security (2012), urban security should be a part of a *strategic plan*, which relies on cooperation among all local actors. Strategic plan is a gate to cooperation of local actors because of its rationale in recent development thinking. Security policy and planning have become more decentralized (Boddy, 2008; Coaffee *et al*, 2009; Nemeth, 2010) as a result of this strategic approach. Decentralization has occurred as shifting decision making process relatively from national to local level and transferring control from public authorities to public-private partnerships.

Local actors have gained roles in providing urban security throughout this process as well as local policies have emerged as response to urban security needs. So, urban security is, inter alia, one of the fields of urban planning with participatory governance strategies (Friedman, 2005; Dupont, 2006; EFUS, 2006; 2012; UNODC and UN-Habitat, 2011). Participatory governance strategies rely on involving the population in local decision-making and governance structures and processes, such as participatory budgeting, local assemblies sponsored and supported by the government.

Another dimension of urban security is technology. Little (2004) argues that response to urban security issues necessitates *flexible and agile* structures, asserting that investments in emergency response technologies, strategies, and organizations are those of cost effective ones because they are relatively independent of time and place. Given the security threats to people in urban areas such as terrorism and organized crime, structuring technology intensive security is considered to be an efficient response to rapidly changing security environment (Mallik, 2004).

As mentioned so far, urban security is a multifaceted issue most of which is related to development concerns. Particularly, it can be said that consequences of rapid urbanization has paved way for security-development nexus studies and the nexus between security and urbanization has been one of the research areas (Beall, 2007). In this study, security-development nexus is

handled at regional basis in order to put into practice it within RDAs and ensure coherence between urban security and regional development policy.

## 2.2. Regional Development and RDAs

Regions within countries may be defined based on a number of characteristics, ranging from administrative areas to shared geographic, cultural or socio-economic features, such as their landscape, climate, language, ethnic origin or shared history. Regions based on these features generally do not fit that of public administrations. Therefore, administrative regions, which are administrative division of countries, may differ from regions based on other features (Cooke and Leydesdorff, 2006). According to Ahmad and Bajwa (2005), the region is the *physical, economic, social and institutional environment* in which development occurs at both national and local level.

Regional development theory relies heavily on neoclassical theory and growth theory. Those theories constitute the conceptual basis of regional development thinking (Dawkins, 2003: 134). For example, regional development thinking asserts that central, local and regional authorities may plan at regional scale in order to attract investments from outside and national and local benefit may be realized at the same time. Furthermore, in countries where market mechanisms dominate the economy, planning is seen to be local and urban. (Ahmad and Bajwa, 2005).

Regional development has two prime components (Adams *et al*, 2016): *regional policy, regional planning*. Regional policy is a way of national government intervening in the distribution of various activities between its different regions, and has usually focused on the distribution of economic activities. Regional planning is comprised of decision making at the regional level. Regional policy focuses on inter-regional issues, while regional planning deals with broader set of issues within a region. The mechanisms for regional planning and the necessary institutions vary. Regional planning may be carried out by decentralized administrative bodies of central government or by elected regional governments.

OECD (2010) puts forward the paradigm shift concerning regional development thinking (see Table-1). These change demonstrates also the basis upon which security-development nexus can be built. By giving basic principles of regional development approach, Table-1 draws a conceptual framework for establishing urban security-regional development nexus. Thus it provides with an appropriate point of departure to match urban and regional scales.

Table 1. Paradigm Shift of Regional Development Policy

Dimension	Old Paradigm	New Paradigm
Problem Recognition	Regional disparities in income, infrastructure stock, and employment	Lack of regional competitiveness, underused regional potential
Objectives	Equity through balanced regional development	Competitiveness and equity
General Policy Framework	Compensating temporally for location disadvantages of lagging regions, responding to shocks (Reactive to problems)	Tapping underused regional potential through regional programming (Proactive for potential)
Instruments	Subsidies and state aid (often to individual firms)	Mixed investment for soft and hard capital (business environment, labor market, infrastructure)
Actors	Central government	Different levels of government, various stakeholders (public, private, NGOs)

Source: OECD (2010).

In this new paradigm, *unit of policy intervention is functional areas* rather than administrative areas of old one. Taking into account Table-1 and OECD (2010) recommendations, it is likely to extract structural and functional aspects to be embedded within RDAs in order to operationalize security-development nexus. In political discourse, RDAs are regarded as the operational arm of regional development. A RDA is defined as “*a regionally based, publicly financed institution outside the mainstream of central and local government administration designed to promote economic development through an integrated use of predominantly soft policy instruments.*” (Halkier and Danson, 1998). According EURADA (1999), “*RDA is an operational structure that identifies sectoral or overall development problems, chooses a range of opportunities or methodologies (...)*”.

What is expected in this structure is *semi-autonomous character and a broad range of policy instruments* (including “soft” ones) (Halkier *et al.*, 1998). Because RDAs are considered to be inductive to bridging the gap between economic policy and other policy domains at regional level (McMaster, 2006; Syrett and Silva, 2001). According to Danson and Halkier (2005), a

RDA is expected to develop an comprehensive approach and integrated strategy that primarily aims at strengthening the indigenous sector of the *economy*. Then the central task of this structure is to draw up a long-term overall *strategic plan*.

RDAs provide three basic services: *advice, finance and infrastructure* (Halkier and Danson, 1998).As the RDA structures have evolved, their new functions have emerged over time as a response to rising challenges (EURADA, 1999). What has not been addressed seems to be the security-development nexus. Regardless of their varying types and backgrounds, RDAs must be complemented by security-development nexus as sustainable development demands. It does not mean that national context will be ignored. On the contrary, national context is considered to be the framework for security-development agenda.

RDAs vary according to their structures. One of the determinants of structure is RDA's autonomy with respect to central and local stateauthority. And that determines the organization of RDAs. Given that security is almost a public good today, it seems apparently that giving an executive authority to RDAs in enforcing security rules at regional levelis controversial.Then we require to incorporate some advisory and joint planning roles/functions into RDAs in accordance with national security priorities and local security needs. That is, RDAs will play a mediating and bridging role in aligning national and local levels.

### 3.OPERATIONALIZING URBAN SECURITY-REGIONAL DEVELOPMENT NEXUS

#### 3.1.Establishing Urban Security-Regional Development Linkage

Linking urban security and regional development should start from macro-level establishing relationship within and between security and development. Figure 1 represents how to establish this relationship. Each policy/strategy/plan/agency/document are prepared accordingly so that policy coherence could be realized. Since urban development is considered to play a vital role regional development (European Commission, 2009), urban security is taken as a prospective component of regional development organization/planning in this study as well.

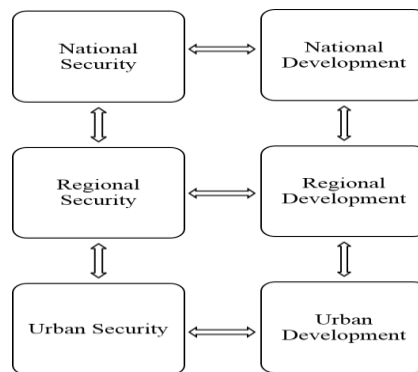

Figure 1. Urban Security-Regional Development Linkage (Conceptual Model)

What is lacking in present security structures is (sub-national) *regional security* approach. In establishing a linkage between urban security and regional development, we need regional security thinking. I argue that regional security approach should denote a security thinking at regional level in its regional development ecosystem. Here, regional security structure comprises of a variety of urban security challenges. In other words, it can be said that regional security approach plays a mediating role between urban security needs and national security priorities.

According to Figure 1, security needs must be defined at regional basis in accordance with national security and regional development process, and getting input from urban security needs as well. And regional development process should be conducted by incorporating regional security concerns. In this way, both national security and development processes can be merged to yield policy coherence and alignment.

In this context, it is possible to connect regional development process directly to urban security as well. Nevertheless, backed by a comprehensive regional security policy/strategy/plan/agency/document, urban security needs could be optimized among region's competing development and security concerns. One might talk about building *Regional Security Agencies (RSAs)*. Even this might be useful. But building security agencies at regional basis tied to central government creates another structure to be coordinated with RDAs.

#### 3.2. Identifying Urban Security Ecosystem (USE)

An ecosystem, when it is defined in social science terms, refers to a complex set of dynamic relations and interactions among its components in an environment (Moore, 1993; Basole *et al.*, 2015). That is, security bodies evolve in changing conditions that result from continuous interactions of a variety of factors. In an ecosystem, there is competition as well as cooperation. An ecosystem can be defined *asa set of interconnected security/security related actors, organizations, institutions and processes* (Mason and Brown, 2014).

Ecosystems, composed of both public and private bodies, are dependent on both external and internal factors. External factors, such as resources, government regulations etc. control the overall structure of an ecosystem and the way things work within it, but are not themselves influenced by the ecosystem (Pfeffer and Salancik, 1978). Internal factors not only control ecosystem processes but are also controlled by external factors and are often subject to [feedback](#). While the [resource](#) inputs are generally controlled by external processes, the availability of these resources within the ecosystem is controlled by internal factors.

Since regional development approach cover whole region comprised of both urban and rural areas without making any physical distinction, urban security in the sense of regional development refers to a specific (urban) piece of land. To start, we need to define actors and their interrelations of security environment at urban scale, which I call it as *Urban Security Ecosystem (USE)*. In this context, USE should include both public and private security bodies interacting in a given security environment. Figure 2 demonstrates Urban Security Ecosystem, which I suggest it is useful to link urban security and regional development.

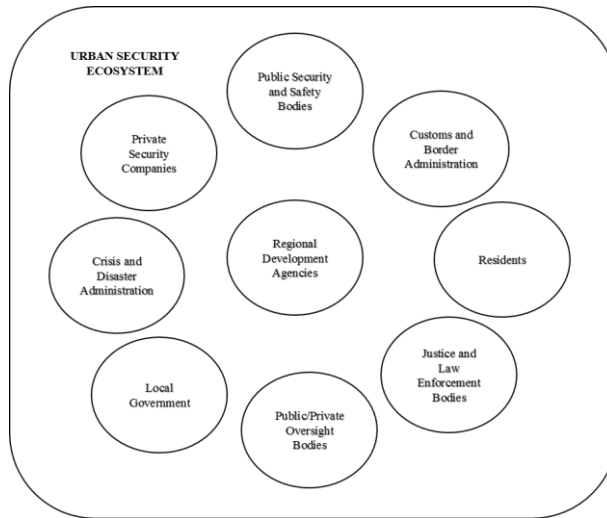

Figure 2. Urban Security Ecosystem

USE, shown as Figure 2, includes those actors that perform urban security planning, implementation, monitoring and evaluation. In the USE, RDA has a central role/authority to operationalize security-development nexus. That is, urban security process is oriented within broader framework of regional development.

### 3.3. Incorporating Urban Security into RDA

Giving RDAs a central role in performing urban security necessitates an inner structure to orient process. For instance, UNODC and UN-Habitat (2011) assert that building *planning commissions* comprised of both security and development personnel at regional or provincial level can combine expertise areas in making decisions of urban security. Below discussed are the dimensions of operationalization of the nexus.

#### Policy Coherence

The central theme of security-development nexus is *policy coherence*. Policy coherence can be achieved by harmonization through both security and development policy processes (OECD, 2015). Given that this study focuses on embedding security into development at structural basis, here it suggests that nested sub-structures of security-development nexus in RDAs will serve to its operationalization. Those structures are essentially will be composed of both security and development experts.

#### Organization

Here, I suggest that creating a joint structure, as an *institutional mechanism* envisaged by OECD's policy coherence approach based on policy interaction (OECD, 2015), in RDAs should start from planning process so that policy coherence can be achieved subsequently (see Figure 3).

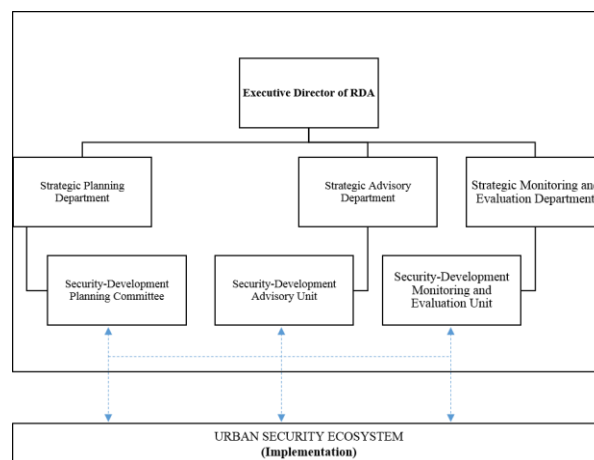

Figure 3. Security-Development Organization in RDAs (Suggested)

## Planning

As mentioned above, one of the prime functions of regional development policy is planning. For this study, as well, planning process is the starting point of operationalizing and establishing security-development nexus. That is, establishing *joint planning committees of both security and development experts* are appropriate for the task. As shown in Figure 3, the planning committee is subordinated to one of the main functional components of RDAs, Strategic Planning Department. And planning committee has strategic planning task regarding security-development issues.

## Advising

Advice is a form of relating personal or institutional opinions, belief systems, values, recommendations or guidance about certain situations relayed in some context to another person, group or party often offered as a guide to action and/or conduct ([www.en.wikipedia.org](http://www.en.wikipedia.org), 05.07.2016). A RDA should and can identify security sector problems as well. In terms of policy instruments, as a requirement of security-development nexus, soft policy instruments have the potential to address policy problems. One of the soft policy instruments is *advice*, as Halkier *et al.* (1998) argued. RDAs can give advice to security institutions at regional level regarding development aspects of security. This policy instrument requires a responsible unit, that is, *Security-Development Advisory Unit* within RDAs.

## Monitoring and Evaluation

Monitoring and evaluating the progress based on sound data is one of the targets of development cooperation and sustainable development (United Nations, 2015). As shown in Figure 3, monitoring and evaluation processes are aligned with development planning. Policy targets and indicators of security-development nexus are embedded into existing monitoring and evaluation framework. So, developing indicator sets is one of the primary tasks of operationalizing the nexus in monitoring and evaluation framework. Established subordinated to strategic monitoring and evaluation department of RDA, Security-Development Monitoring and Evaluation Unit would conduct this process based on security-development policy targets and indicators.

## Funding/Budgeting

It is apparent that both international development cooperation and 2030 Sustainable Development Agenda demand public-private partnership in funding policy programs (United Nations, 2015). Security-development programs can be funded within existing budgeting process. What is to be taken into account here is how and at what level public and private funding could be merged. Funding mechanisms may vary from public funding pools of development and security allowances to project-based public-private funds (World Bank, 2013). Consequently, it will depend on the degree of decentralization of administration in a given country.

## 4. CONCLUSION

Security-development nexus is an attempt to integrate development and security policies. The need for integration has arisen from the notion that both security and development constitute the preconditions of each other. One of the major issues in this regard is policy-practice gap. In other words, operationalizing security-development nexus awaits to be addressing. This study aims to make a contribution to bridging the gap between policy and practice.

This entails an operational-level thinking which is based on identifying security-development nexus components. In this context, the first contribution of this study is building a conceptual model of security-development linkage. Secondly, the urban security ecosystem is defined in order to recognize actors that are supposed to interact. RDA holds relatively the central place in this ecosystem since security-development nexus is constructed inside of it. Thirdly, security-development organization inside the RDA should be related to urban security ecosystem as well as to each other.

The structural components of security-development nexus within RDA have been determined according to both urban security and regional development approach. Structural components are *policy coherence, planning, advising, monitoring and evaluation, and funding*. These components also reflect sustainable development policy targets, which emphasize policy coherence, partnership and governance. The study is not a "one size fits all" work. Security-development structures can be built outside the RDA organization. In this case, it should be noted that some fragmentation and coordination problems may occur hindering policy coherence, alignment and harmonization.

## REFERENCES

- [1] Adams, N., Alden, J. and Harris, N. (Eds.), *Regional Development and Spatial Planning in an Enlarged European Union*, Routledge, London, 2016.
- [2] Ahmad, I. and Bajwa, I. U, *Regional Development Planning: Issues and Realities*, 41st ISOCaRP Congress, 2005
- [3] Basole, R. J., Russell, M. G., Huhtamaki, J., Rubens, N., Still, K. and Park, H., "Understanding Business Ecosystem Dynamics: A Data-Driven Approach", *ACM Transactions on Management Information Systems (TMIS)*, Vol. 6, No. 2, 6, July 2015.
- [4] Beall, J., *Cities, Terrorism and Urban Wars of the 21st Century*, Crisis States Research Centre Working Paper No.9, DESTIN, London, 2007.
- [5] Boddy, D., *Management: An Introduction*, FT Prentice Hall, USA, 2008.
- [6] Boemcken, M., "Revisiting the Security-Development Nexus", in *Commercial Security and Development Findings from Timor-Leste, Liberia and Peru*, (pp. 7-8), Bonn International Center for Conversion, Germany, 2011.
- [7] Chandler, D., "The Security-Development Nexus and the Rise of Anti-Foreign Policy", *Journal of International Relations and Development*, Vol. 10, pp. 362-386, 2007.
- [8] Coaffee, J., O'Hare P. and Hawkesworth M., "The Visibility of (In)security: The Aesthetics of Planning Urban Defences Against Terrorism", *Security Dialogue*, Vol. 40, pp. 489-511, 2009.

- [9] Cooke, P. and Leydesdorff, L., "Regional Development in the Knowledge-Based Economy: The Construction of Advantage", *Journal of Technology Transfer*, Vol. 31, No. 1, pp. 5-15, January 2006.
- [10] Dawkins, C. J., "Regional Development Theory: Conceptual Foundations, Classic Works, and Recent Developments", *Journal of Planning Literature*, Vol. 18, No.2, November 2003.
- [11] Denney, L., "Reducing Poverty with Teargas and Batons: The Security-Development Nexus in Sierra Leone", *African Affairs*, Vol. 110, No. 439, pp. 275-294, 2011.
- [12] Duffield, M., "The Liberal Way of Development and the Development-Security Impasse: Exploring the Global Life-Chance Divide", *Security Dialogue*, Vol. 41, No. 1, pp. 53-76, 2010.
- [13] Dupont, B., "Delivering Security through Networks: Surveying the Relational Landscape of Security Managers in an Urban Setting", *Crime, Law & Social Change*, Vol. 45, pp. 165-184, 2006.
- [14] EURADA, *Creation, Development and Management of RDAs: Does it have to be so difficult?*, EURADA, Brussels, 1999.
- [15] European Commission, *Promoting Sustainable Urban Development in Europe Achievements and Opportunities*, Brussels, 2009.
- [16] European Forum for Urban Security, *The Saragossa Manifesto*, Barcelona, 2006.
- [17] European Forum for Urban Security, *Security, Democracy and Cities: The Aubervilliers and Saint-Denis Manifesto*, Paris, 2012.
- [18] Friedman, J., "Planning Cultures in Transition", in B. Sanyal (ed.), *Comparative Planning Cultures*, (pp. 29-44), Routledge, New York, 2005.
- [19] Gressgård, R., "Plural Policing and the Safety-Security Nexus in Urban Governance: The Expanded Cohesion Agenda in Malmö", 2015, <http://www.rc21.org/en/wp-content/uploads/2014/12/G1-Gressg%C3%A5rd.pdf>, 03.06.2016.
- [20] Halkier, H., Danson, M., "Regional Development Agencies in Europe-A Survey of Key Characteristics and Trends", in H. Halkier et al. (Eds.), *Regional Development Agencies in Europe*, (pp 26-44), Jessica Kingsley, London, 1998.
- [21] Halkier, H., Danson, M. and Damborg, C. *Regional development agencies in Europe*, Jessica Kingsley London, 1998.
- [22] International Peace Academy, *Strengthening the Security-Development Nexus: Assessing International Policy and Practice Since the 1990s*, New York, 2004.
- [23] Jackson, P., "Introduction: Security and Development", in P. Jackson (Ed.), *The Handbook of International Security and Development*, (pp. 1-15), Edward Elgar Publishing, Cheltenham, 2015.
- [24] Little, R. G. "Holistic Strategy for Urban Security", *Journal of Infrastructure Systems*, Vol. 10, No. 2, pp. 52-59, 2004.
- [25] Mallik, A., *Technology and the Security in the 21st Century: A Demand-Side Perspective*, SIPRI Research Report No. 20, Oxford University Press, Stockholm, 2004.
- [26] Mason, C. and Brown, R., *Background Paper Prepared for the Workshop Organized by the OECD LEED Programme and the Dutch Ministry of Economic Affairs on Entrepreneurial Ecosystems and Growth Oriented Entrepreneurship*, The Hague, Netherlands, 7th November 2013.
- [27] McMaster, I., "Czech Regional Development Agencies in a Shifting Institutional Landscape", *Europe-Asia Studies*, Vol. 58, pp. 347-70, 2006.
- [28] Moore, J., "Predators and Prey: A New Ecology of Competition", *Harvard Business Review*, May 1993.
- [29] Nemeth, J., "Security in Public Space: An Empirical Assessment of Three US Cities", *Environment and Planning*, Vol. 42, pp. 2487-2507, 2010.
- [30] Nikolaisen, T., *Security Sector Reform: A new Framework for Security Assistance? The Security-Development Nexus Impact on Policies towards the South*, Norwegian Institute of International Affairs, Norway, 2011.
- [31] OECD, *Regional Development Policies in OECD Countries*, OECD Publishing, Paris, 2010.
- [32] OECD, *Better Policies for Development 2015: Policy Coherence and Green Growth*, OECD Publishing, Paris, 2015.
- [33] Pfeffer, J. and Salancik, G., *The External Control of Organizations: A resource Dependence Perspective*, Harper & Row, New York, 1978.
- [34] Recasens, A., Cardoso, C. and Josefina Castro, G. G. N., "Urban Security in Southern Europe", *European Journal of Criminology*, Vol. 10, No. 3, pp. 368-382, 2013.
- [35] Schnabel, A., "The Security-Development Discourse and the Role of SSR as a Development Instrument", in A. Schnabel, V. Farr (Eds.), *Back to the Roots: Security Sector Reform and Development*, (pp.29-73), Geneva Centre for the Democratic Control of Armed Forces, Switzerland, 2012.
- [36] Syrett, S. and Silva, C. N., "Regional Development Agencies in Portugal: Recent Development and Future Challenges", *Regional Studies*, Vol. 35, pp. 174-80, 2001.
- [37] United Nations, *Transforming Our World: The 2030 Agenda for Sustainable Development*, United Nations, New York, 2015.
- [38] UNDP, *Human Development Report 1994*, UNDP, New York, 1994.
- [39] UN-Habitat, *Enhancing Urban Safety and Security: Global Report on Human Settlements 2007*, USA, 2007.
- [40] UNODC, UN Habitat, *Introductory Handbook on Policing Urban Space. Criminal Justice Handbook Series*, United Nations, New York, 2011.
- [41] World Bank, *World Development Report 2011: Conflict, Security, and Development*, Washington, DC, 2011.
- [42] World Bank, *Financing for Development Post 2015*, Washington, DC, 2013.
- [43] [www.en.wikipedia.org](http://www.en.wikipedia.org), 05.07.2016.

## BIOGRAPHY

Ahmet Barbak is an Asst.Prof. at Department of Political Science and Public Administration, İzmir Katip Celebi University, Turkey. He graduated from Turkish Military Academy in 2001. He completed MBA at Gazi University in 2008. He got his PhD degree from Public Administration at Ankara University in 2015. He has language proficiency in English and Italian.



# Effects Of Energy Drinks With Alcohol Consumption

*Mumin Polat<sup>1</sup>, Serkan Koksoy<sup>1</sup>, Canan Demir Barutcu<sup>1</sup>, Gulcihan Aybike Dilek<sup>1</sup>*

---

## Abstract

Especially among students in recent years, energy drinks with alcohol consumption has become popular and is known to the acquisition of risky behavior. According to researches; of consuming energy drinks with alcohol, compared to only consume alcohol, it reveals that they use two times more alcohol. Serious injury, sexual assault, drunk driving car, more deaths are related to alcohol consumption. When consumed with alcohol and energy drinks, there has been a dramatic increase in these adverse events.

Energy drink consumption among 18-24 year olds, the results of a survey conducted on 697 students, when students mix energy drinks with alcohol; sexual abuse, physical damage, reveals that they experience negative effects, such as the need for additional medical treatment. Students often; To hide the taste of alcohol and drunkenness to get more alcohol to feel the next day, to remain under the influence of alcohol and other reasons stated that they mix alcohol with energy drinks. Energy drinks and alcohol consumption, although increasing with each passing day, there are no controlled studies on the subject. However, energy drinks and alcohol with consumption of alcohol on the central nervous system, there are many popular publications for that reduce the depressant effects. It is reported energy drinks might reduce the intensity of the depressant effects of alcohol, and this effect is attributed to energy drinks with alcohol antagonist relationship. However, little scientific data on the subject, and some do not support this view. Therefore, caution should go and should raise awareness on the topic in the community.

**Keywords:** *Alcohol Consumption, Energy Drinks, Health*

---

## 1.INTRODUCTION

The use of energy drinks are popular since the 90s, especially among young consumers "energy or power drink ", sports nutrition "under the name of consumption is increasing. Energy drinks are sold in our country, it is known that at the beginning of the 90s. As of today, all over the world and our country, "Red Bull, Burn, Powerade, Monster, Rockstar, NOS, Full Throttle, Black Cold, Bomb, Crystal, Full Force, Power Bull, Deep Crazy Bull, the Buzz, Tiger Shot, Shark, Sole, Red Devil Red Daragon, Red Zone, Blue Ox, Buffalo, Contig is fantastic, Fire Ball, Fire, Water, Flash, Liquid, Full Force, Full Power, Kick 4 Four, Maddox, Matador, Nexcitein to Pep One, Toreador, Zebra, Red Bat, an American Bull, Jack Wrestler, Reload, Royce Gold, the Red Edicitio, the Blue Edicitio like "widely sold under the brand names.

### 1.1.History of Energy Drinks

Used to improve performance and can also be called as the first drink sports drinks it has been reported to be used in 1939.<sup>1</sup>Energy Drink beverage of the precursor may be the first time that America Chicago in mass production in 1949, in Japan in 1960, 1980 is well known that the manufacture of similar drinks in the UK. Common sense in the world to use the current version of the year the sale of energy drinks in Turkey but across the 1980s corresponds to the 1990's. about 25 brands sold in Turkey in the EU, which also takes place on the shelves of many brands in small batches, it is stated that the total number of brands reached 42. The performance drinks, energy drinks under the first manufactured in the United States and Japan in 1970, after 10 years, has widespread use in Europe. year began to spread in Europe, the Red Bull is the brand entered the market in 1997.<sup>2</sup>The combination of alcohol and energy drinks consumption, despite the reduction of individual perceptions about some symptoms of alcohol intoxication, some effects (reduction in motor coordination and reaction time views, breath alcohol level) has been in existence.<sup>3</sup>

### 1.2.Effects of Alcohol Consumption of Energy Drinks With Alcohol

Especially among students in recent years, energy drinks of alcohol consumption has become popular and is known to the acquisition of risky behavior. The research results of consuming energy drinks with alcohol, compared to only consume alcohol, it reveals that they use two times more alcohol. In addition, men over women, were determined to take more risks.<sup>4</sup>Serious injury, sexual assault, drunk driving car, more deaths are related to alcohol consumption. When consumed with alcohol and energy drinks, there has been a dramatic increase in adverse events.<sup>5</sup>It is reported, energy drinks might reduce the intensity of the depressant effects of alcohol, and this effect is attributed to energy drinks with alcohol antagonist relationship. However, little scientific data on the subject, and some do not support this view.<sup>6</sup>Energy drinks to improve physical and mental performance, increases the ability to drive a car, it is claimed that long-term care and reduce mental fatigue.<sup>4</sup>Adolescents between the ages of 15-19 years, consumption of caffeine has been found to particularly increase the systolic blood pressure and lead to sleep disorders.<sup>7</sup>In the afternoon (14: 00-17: 00), followed by 1 night insomnia, in a study of 12 healthy young,

---

<sup>1</sup> Mehmet Akif Ersoy University Faculty of Health Science, Burdur/Turkey<sup>1</sup> [mpolat@mehmetakif.edu.tr](mailto:mpolat@mehmetakif.edu.tr), [skoksoy@mehmetakif.edu.tr](mailto:skoksoy@mehmetakif.edu.tr), [cdemir@mehmetakif.edu.tr](mailto:cdemir@mehmetakif.edu.tr), [aybikedilek@gmail.com.tr](mailto:aybikedilek@gmail.com.tr)

monotonous car sucrose during driving, glucose, 80 mg of caffeine, taurine, glukoronolakto and 250 ml energy drink consumption containing vitamins sleepiness and it was found to reduce accidents.<sup>8</sup>In particular, two or more energy drinks after use; seventeen-year-old male patient with coronary artery spasm, and in another case of cardiac arrest have been observed. In these cases the energy drinks caused by endothelial dysfunction by increasing the platelet aggregation has been reported to induce the blood pressure. In particular, caffeine, glucuronolactone, carnitine, ginseng has been implicated as components.<sup>9,10</sup>Energy drinks cognitive performance (memory, attention ...) effect on stems from the caffeine it contains. taurine found in energy drinks, stimulating effect of elements such as glukoronolakto and work related interactions with one another remained missing.<sup>11,12</sup>Besides caffeine, guarana, have not been reported in the literature energy drinks containing herbal supplements such as ginseng and ginkgo ones though, many clinical cases associated with the consumption current.<sup>13,14</sup>In people with asthma and allergies, serious complications with energy drink consumption, including after using the drug ephedrine (nausea, dizziness, chest tightness during car use, fatigue, fainting, hypertension, tachycardia ...) is inferred.<sup>15</sup>Using energy drink, reducing the water consumption can cause decreased saliva and dental erosion. Decreased salivary flow, salivary buffering ability reduction and accelerate the formation of dental caries and dental erosion increases accordingly.<sup>16</sup>Recent studies conducted in rats and humans, it is stated that caffeine and taurine to stimulate the diuresis and natriuresis. Healthy 12 male volunteers, 4 separate tests drink (240 mg of caffeine and 3 g with energy drinks containing taurine, caffeine and 3 test drinks contain taurine) in a study given after 12 hours of fluid restriction, urine output and natriuresis are increased with caffeine, beverage consumption containing taurine after it was found that there is no change. The study shows that the tested energy drinks diuretic and natriuretic effects caused by caffeine. Taurine; moderately dehydrated, fluid balance in healthy young consumers that significantly affect, the energy drink diuretic potential is to be noted that various other beverages containing caffeine.<sup>17</sup>

Energy drinks; heart rate, blood pressure was investigated in a study to influence ECG and blood glucose metabolism. It does not affect the metabolism of glucose energy drink, decrease in diastolic blood pressure, systolic pressure and caused an increase in heart rate was found to be of significant clinical effects on ECG parameters.<sup>18</sup>High-sugar, low-caffeine-containing beverages; to reduce sleepiness and even further increase "is working on interesting results have been achieved. High-sugar level, despite the short-term to create the effect of increasing alertness or physical energy, then increase the sleepiness. Some energy drinks are also high sugar, it has a low caffeine content. In a study done, after a light lunch, 42 g sugar, 250 ml after the consumption of energy drinks containing caffeine 30 mg low levels were found not become irresistible sleepiness. This results; with major changes in blood glucose levels (hypoglycemia rebounds) it is described. In this case, the caffeine content of energy drinks on the agenda and in the case of low "due to sleepiness sugar into money, turning effect of caffeine did they remain insufficient to reverse this situation" suggests the question. In short, if the low level of caffeine in energy drinks, which reduce the level of sleepiness, even after attention was drawn to an increased sleepiness.<sup>19</sup>

## 2.RESULTS

Energy drinks and alcohol consumption, although increasing with each passing day, there are no controlled studies on the subject. However, energy drinks and alcohol with consumption of alcohol on the central nervous system, there are many popular publications for that reduce the depressant effects. It is reported energy drinks might reduce the intensity of the depressant effects of alcohol, and this effect is attributed to energy drinks with alcohol antagonist relationship. However, little scientific data on the subject, and some do not support this view. Therefore, caution should go and should raise awareness on the topic in the community.

## REFERENCES

- [1] Ford, M. A., *Â The Formulation Of Sports Drinks. In: Production And Packaging Of Non-Carbonated Fruit Juices And Fruit Beverages,Â Ashurst P.R. Gorthersburg, Maryland: An Apsen Publication . 1999. pp. 311-329.*
- [2] Anon. F, Avusturya'dan Esen Rüzgar; Red Bull Energy Drink R. Dünya Gıda Dergisi, Haziran, pp. 14, 311998.
- [3] Ferreira, S.E., Mello, M., Pompeia, S. et al. Effects of energy drink ingestion on alcohol intoxication. *Alcoholism, clinical and experimental research*, vol. 30 (4), pp.598, 2006.
- [4] Woolsey, C.L. A study of NCAA division athletes on the use and effects of combining alcohol and energy drinks. The Faculty of the Graduate School University of Missouri, Columbia, 2007.
- [5] O'Brien, M.C., McCoy, T., Rhodes, S.D., Wagoner, A., Wolfson, M. Caffeinated cocktails: energy drink consumption, high-risk drinking, and alcohol-related consequences among college students. *Academic Emergency Medicine*, vol. 15 (5), p. 453, 2008.
- [6] Ferreira, S.E., Mello, M., Pompeia, S. et al. Effects of energy drink ingestion on alcohol intoxication. *Alcoholism, clinical and experimental research*, vol. 30 (4), p. 598, 2006.
- [7] Savoca MR, MacKey L, Evans CD, Wilson M, Ludwig DA, Harshfield GA. Association of ambulatory blood pressure and dietary caffeine in adolescents. *Am J Hypertens* vol. 18:pp. 116-20, 2005.
- [8] Reyner, L.A., Horne, J.A. Efficacy of a "functional energy drink" in counteracting driver sleepiness. *Physiology & Behavior*, vol. 75, p. 331, 2002.
- [9] Berger AJ, Alford K. Cardiac arrest in a young man following excess consumption of caffeinated "energy drinks". *Med J Aust*, vol. 190(1), p.41-3, 2009.
- [10] Wilson RE, Kado HS, Samson R, Miller AB. A Case of Caffeine-Induced
- [11] Coronary Artery Vasospasm of a 17-Years Old Male. *Cardiovasc Toxicol*, vol12(2), pp.175-9, 2012.
- [12] Riesselmann, B., Rosenbaum, F., Scheider, V. Alcohol and energy drink- can combined consumption of both beverages modify automobile driving fitness? *Blutalkohol*, vol. 33 (4), p. 201, 1996
- [13] Babu, K.M., Church, R., Lewander, W. Energy Drinks: The new eye-opener for adolescents. *Clinical Pediatric Emergency Medicine*, vol. 9, p. 35, 2008.
- [14] Iyadurai, S.J., Chung, S. New-onset seizures in adults: possible association with consumption of popular energy drinks. *Epilepsy Behavior*, vol. 10 (3), p.504, 2007.
- [15] Nagajothi, N., Khraisat, A., Velazquez-Cecena, J.L., Arora, R., Raghunathan, K., Patel, R., Parajuli, R. Energy drink related supra ventricular tachycardia. *The American Journal of Medicine*, vol. 121 (4), 2008.

- [16] Tai, F.M. Adverse effects of primatene mist used in combination with energy drink containing ephedra alkaloids. *Journal of Allergy and Clinical Immunology*, vol. 111 (1), p. 167, 2003.
- [17] E.Özel, K.Gökçe. Spor İçecekleri ve Dental Erozyon. Atatürk Üniv Diş Hek Fak Derg 2006; (Suppl):14-17
- [18] Riesenhuber, A., Boehm, M., Posch, M., Aufriect, C. Diuretic potential of energy drinks. *Amino Acids*, vol. 31 (1), p. 81, 2006.
- [19] Sterinke, L., D.P., Manlogat, E., Berlie, N., Klaus, J.S. (2008) The effects of on energy drink” on cardiovascular and metabolic parameters, California
- [20] Anderson, C., Horne, J. A high sugar content, low caffeine drink does not alleviate sleepiness but may worsen it. *Human Psychopharmacology*, vol. 21, p. 299, 2006.

# An Evaluation on The Attractiveness of Turkish Economy in Terms of Foreign Direct Investments

*Ilhan Gullu<sup>1</sup>, Nazife Ozge Kilic<sup>2</sup>*

---

## *Abstract*

*Today, foreign direct investment is one of the most important tools that allow countries to make progress in the economic development processes and to integrate with the world economy. Countries that can correctly construe the advantages offered by the globalization process are looking for a way to make their national markets attractive for foreign investors. Turkey is also one of the countries that make efforts in this regard. The fact that Turkey was declared to be a candidate country to the EU in 2005 encouraged foreign direct investments to tend towards Turkey. However, the fact that Turkey has been exposed to internal and external political developments in the last decade negatively affected the amount of financial resources coming to Turkey through foreign direct investment.*

**Keywords:** *Foreign Direct Investment, Place of Investment Preference, Turkish Economy, Developing Countries.*

---

## **1. INTRODUCTION**

Today, the benefits offered by the foreign direct investments including providing financial resources constitute a quite wide range. While multinational companies get a significant opportunity to get into the target market through foreign direct investments, the country where market is located is also transferring technology and improving its human capital. The accelerating effect of foreign direct investments on the economic development process increases if countries make their economic, legal, social and cultural structures closer to international norms. The foreign direct investments that find the said properties in further industrialized countries have also tend towards the developing regions of the world since the 1990s.

Turkey began to follow an outward-oriented economy model since 1980 but was able to make the institutional arrangements which were attractive to foreign investments by the end of the 1990s. Foreign direct investments have come to the forefront after 2000 among the external resources coming to Turkey. The fact that Turkey was declared to be a candidate country to the EU in 2005 was considered as an important step in the process of Turkey's economy's articulation with one of the world's most stable markets by foreign investors, and the amount of foreign direct investments that turned to Turkey was highly increased after this date. However, the foreign investments coming to Turkey have also been affected by the problems experienced in the regional and global economy within the last 10-year period. There have been fluctuations in source entry to Turkey in the form of foreign direct investments due to internal and external political and economic instabilities particularly due to the slowdown of EU membership process.

This study aims to reveal under the influence of which factors the foreign direct investments coming to Turkey are made during 2004-2014 period and to examine the factors that make the national market attractive from the current perspective.

## **2. THE CONCEPT OF FOREIGN DIRECT INVESTMENT, ITS DEVELOPMENT IN THE WORLD AND TURKEY**

Foreign direct investments began in the period after the Second World War in the World. Foreign direct investments began to gain importance along with the increasing liberalization in the post-war period. After the 1950s, Multinational Corporations emerged and played an active role in the world economy. Foreign Direct Investments, Multinational Companies and other forms of international production began to gain importance along with the gradual change of the international economy since the 1960s [1]. Towards the end of the 1970s, the number of MNC increased rapidly and international production gradually began to grow further [2].

### **2.1. Conceptual Framework of Foreign Direct Investments**

Foreign direct investment is a quite comprehensive concept that should be addressed with multiple dimensions. Foreign direct investment "is the fact that a company establishes a production facility or purchases the production facilities in countries outside its headquarter in order to spread its production beyond the borders of the country where it is established" [3]. According to Karluk, foreign direct investment, which is an important tool for the articulation of national economies into the global economy from this aspect, is "the fact that the foreign investor brings along the management information and technology in addition to the purchase of a company or increase of an existing company's capital" [4]. According to the International

---

<sup>1</sup>Nevsehir Haci Bektas Veli Universty, Department of International Relations, Nevsehir, Turkey. [igullu@hotmail.com](mailto:igullu@hotmail.com)

<sup>2</sup>Agri Ibrahim Cecen Universty, Department of Economics, Agri, Turkey, [nokilic@agri.edu.tr](mailto:nokilic@agri.edu.tr)

Monetary Fund, foreign direct investment is "a form of investment across national borders in which a business in a country seizes the control of a business in another country or has a significant effect in the control of that company" [5]. According to this definition, foreign direct investment is realized in four different ways including the establishment of a business in a foreign country or the purchase of at least 10% of the shares of a business which is already established, the investment with the profits of a business in a foreign country in that country and increase in the parent company's shares in the business where it has a share in the foreign country [6]. The foreign direct investment is defined as "the international investment made by the resident investor in an economy with an organization resident in another country in order to establish a permanent benefit relationship" in the sources of Organization for Economic Cooperation and Development [7].

According to new 'Foreign Investment Law' No. 4875 that came into force in 2003, foreign direct investment is defined as "the profits used in reinvestments within the country, rights associated with the extraction and use of natural resources, new companies and branches established, company partnerships that accord the right to vote 10% in addition to cash capital, marketable securities, machinery and equipment, property rights brought from abroad by foreign investors" [8]. In addition, the fact that the foreign investor makes an investment using the internal resources of the country is not an obstacle for the said investment to be considered as a foreign investment [9].

Portfolio investments are the investments outside of the foreign direct investments made on financial instruments such as stock shares and bonds in a foreign country<sup>1</sup>. Portfolio investments are different from foreign direct investments because they are the investments made on attractive areas without intending to intervene in business management. Countries can benefit from portfolio investments to the extent that they can liberalize their economies and make their internal market attractive for foreign investors. However, applications have shown that extreme liberal policies and strict protectionist policies did not give the expected results. The adequacy of the economic infrastructure and the suitability of the social and legal environments are determinants in the preferences of portfolio investments.

## 2.2. Development of Foreign Direct Investments in the World

Although a rapid increase was observed in the global foreign direct investments in 1979-81 period, foreign investments increasingly began to enter into developing countries since the 1990s [10]. 94.2% of the regulations regarding the investment climate in developing countries was in favor of foreign direct investments in the 1990s. It increased rapidly since the mid-1990s and reached 202 billion dollars [11].

Table 1. Foreign Direct Investments in the World (Billion \$)

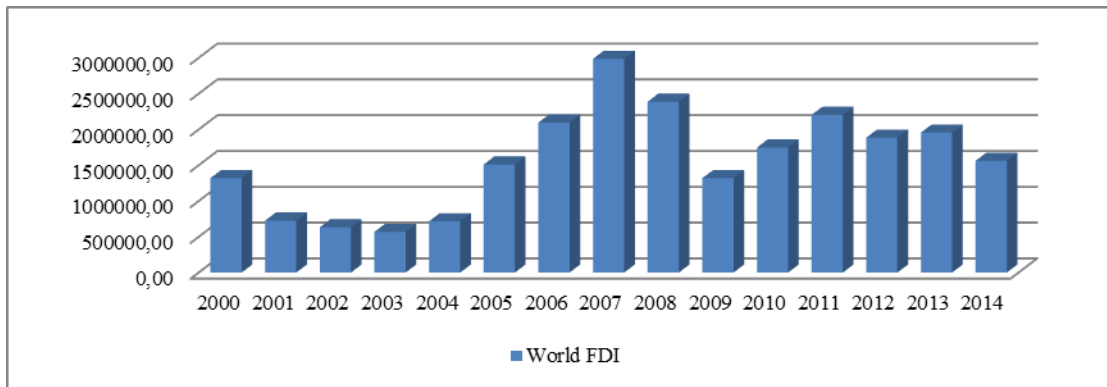

Source: World Bank WDI, 2016 [12].

The development of net capital movements net capital movement from the 2000s until today is presented in Table 1. The amount of foreign direct investment, which was 1,319 billion dollars in 2000, remained in lower amounts until 2004 and increased to 716,659 billion dollars in 2004. Following the increasing trend in the period after 2004, it decreased by 15% compared to the previous year along with the effect of the global crisis in 2008. The reduction in capacity to make an investment due to the constraints in access to financial resources, decrease in investment trends due to the negative expectations for growth and the declines in merger and procurement transactions due to the liquidity squeeze in the financial markets are among the factors causing this decrease [13].

According to the report published by UNCTAD in 2014, foreign direct investment flows that increased by 4.6% in 2013 around the world decreased by 16.4% and fell to 1,561 billion dollars due to the macroeconomic vulnerability and policy uncertainties and geopolitical risks in 2014. Developing countries leave behind developed countries in terms of the place where investment is made and continue to expand the investments they realize in the rest of the world year by year in terms of the investors [14].

## 2.3. Development of Foreign Direct Investments in Turkey

<sup>1</sup>On the other hand, "foreign direct capital investments are the most persistent foreign resource coming to the country. The foreign sources coming through borrowing and portfolio investment leave the country at a small increased risk and are interested in the country's economy or politics unless they negatively affect the investment. However, foreign direct capital investors are closely interested in the progress of the country and become defenders of the country because a problem that would arise will negatively affect their long-term profits <http://www.radikal.com.tr/haber.php?haberno=207721>). Access: 10.04.2016.

Turkish economy failed to make a significant progress until the early 1980s. The macro-economic environment related to investments and the protectionist trade regime which was followed until the end of the 1970s in Turkey have a big role as well as around the world. The beginning of 1980 was a historic milestone in terms of foreign capital investments. As 24<sup>th</sup> January 1980 Decisions, the reform program that passed into the history of Turkish economy aimed at outward growth and transition to industrialization strategy [15]. Along with the January 24<sup>th</sup> Decisions, efforts made to overcome the economic crisis, ensuring stability in domestic politics and stable attitude regarding the continuation of economic reforms increased the confidence of foreign investors in Turkey's economy [16]. The foreign direct investments which were negatively affected by the economic crisis that emerged in the mid-1990s have shown rises and falls by the years [17].

Table 2. Foreign Direct Investments in Turkey (Million \$)

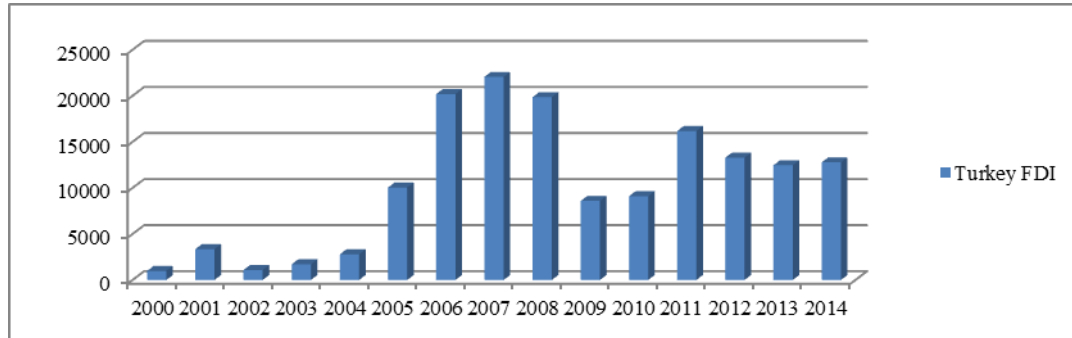

Source: World Bank WDI, 2016 [18].

The fact that a significant change occurred in 2001 is seen in Table 2 when the development of foreign direct investments in Turkey in the 2000s is examined. The sharp increase in foreign capital investment inflows is a remarkable result although Turkey experienced economic crisis in 2001. The foreign direct investments exhibiting a remarkable increase by increasing from 982 million dollars in 2000 to 3,352 million dollars in 2001 decreased significantly due to the financial crisis seen towards the end of 2001. It is seen that the year of 2004 constitutes a significant threshold in terms of hot money coming to Turkey to make speculative portfolio investments. The international direct investments for Turkey entered into increase trend especially since 2005 and reached its highest level, 22,047 million dollars in 2007, but Turkey was also affected by the global direct investment flows decreasing due to the economic crisis which affected the whole world since 2008. The international direct investments that began to increase as of 2010 reached a high value by 16,176 million dollars in 2011 but remained below this figure and at the levels close to each other in 2012, 2013 and 2014.

Table 3. Direct Investment Components in the 1996–2014 Period (Million dollars)

	1996-2005 (Cumulative)	2006	2007	2008	2009	2010	2011	2012	2013	2014
<b>Direct Investment</b>	23,184	20,185	22,047	19,851	8,585	9,099	16,176	13,282	12,457	12,765
Capital (Net)	18,064	16,982	18,394	14,713	6,184	6,221	14,146	10,126	9,298	8,454
Entry (Investment)	19,605	17,639	19,137	14,748	6,266	6,256	16,137	10,759	9,866	8,708
Output (Liquidation)	1,541	657	743	35	82	35	1,991	633	568	254
Other Capital *	938	281	727	2,201	619	384	17	520	110	-236
Real Estate (Net)	4,182	2,922	2,926	2,937	1,782	2,494	2,013	2,636	3,049	4,321

\*The credit received by international capital companies from their foreign partners  
Source: T. C. Ministry of Economy [19].

The foreign direct investment components in Turkey are presented in Table 3. Accordingly, regarding the international direct investment that realized in the amount of a total of 12,765 billion dollars in Turkey in 2014, 8.5 billion dollars of which consisted of capital component and 4,321 billion dollars of which consisted of the purchase of real estates by foreigners.

### 3. PLACE OF PREFERENCE OF THE FOREIGN DIRECT INVESTMENTS AND COUNTRY ATTRACTIVENESS

Foreign direct investments are the part of the international economy and the locomotive of economic development especially in developing countries. Due to foreign direct investments, technology is transferred to the country attracting investment, country's competitiveness is increased, domestic production become acquainted with new management techniques and human capital is developed. Experiences have demonstrated that the benefits of investments to the countries are much more although inconveniences that may arise in terms of the countries attracting investment were seen in some instances [20].

#### 3.1. Foreign Direct Investments and Country Attractiveness

The nonhomogeneous distribution of foreign direct investments in the world indicates that some regions and countries are more attractive than the others in terms of the firms making investments. This situation indicates that the investments tend depending on the features of the places of investments.

### 3.1.1. Place of Investment and Attractiveness

The place of investment primarily refers to an area specified by the boundaries. In the most general sense, the area is a socialized place with boundaries and administrative structure on which a nation or community takes shelter [21]. In this context, area also refers to a social structure that represents the communities living in it and reflects the economic, ideological and political features [22]. It is possible to talk about a few key features of the area based on the definitions made to express it as a term [23].

- A localized, technological and external system.
- Social and economic relations system.
- A local management system.

Along with the elimination of the boundaries in the globalization process, the areas on which nations or communities take shelter have become the center of attraction of the appreciation of other nations or firms. Economic integration efforts are examples of the attempts to increase the attractiveness on a regional basis. Like in the example of EU, when it comes to economic and monetary union, the purpose is to become the center of attraction of economic activities rather than increasing the foreign trade volume and competitiveness of the member states [24].

Area attractiveness can be defined as the capacity of a place to attract foreign investments. This can be understood as the fact that a foreign business succeeds in being in the first place in investment preferences and also as the fact that a readily available foreign investment make reinvestments by profits or ensure that they would not leave there.

Therefore, today, the place of investment is among the study subjects of many disciplines including sociological, anthropological and historical as well as geographical features. In terms of economics, the place of investment refers to many values such as geostrategic importance, underground and aboveground resources as well as geographical coordinates.

### 3.1.2. Factors Ensuring the Attractiveness of a Place in terms of Investments

The fact that the investments are not evenly distributed in the world brings attractive aspects of some regions or countries into the forefront compared to others. Many EU member countries are perceived as a center of attraction for foreign investors because they are included in the common market. The factors affecting the attractiveness of France located both in the EU and European regions are defined as follows in the reports prepared about the subject:

- Area, people and quality of life,
- Research-development and vocational training activities,
- Taxation, social and legal environment [25].

While geographical location, human capital and quality of life increase the attractiveness of France in terms of investments, its taxation and social security system decrease the attractiveness of the country. When it comes to Turkey, the fact that Turkey gained the EU candidate status has increased the attractiveness of the country in terms of foreign investors since 2005<sup>1</sup>.

Different methods are used to measure the attractiveness of the countries in terms of foreign investments. In addition to the questionnaire studies performed on the actors of the sector each year, econometric analyses are also performed by using macro-economic indicators. Besides, indicators established by international organizations are also the referenced sources. In this sense, United Nations Conference on Trade and Development (CNUCED) specified the following 12 indicators from among numerous criteria used.

- GDP per capita
- Growth rate of GDP per capita in the last 10 years
- The share of export within GDP
- The number of fixed-line and mobile phone used in the country
- Energy consumption per person in the private sector
- The share of research and development expenditures of public and private sectors in the country within GDP
- The share of import within GDP

---

<sup>1</sup> The analyses performed have indicated that the fact that Turkey was declared as the candidate country in the EU membership process is a motivating factor for foreign investors. See for one of the studies on this issue: İlhanGüllü and NazifeÖzgeKılıç et al. "A research to determine the role of process of Turkey's entry to European Union on the foreign direct investment" Procedia 2013.

- The share of the country among the foreign investments entered on a global scale
- Country Risk
- The share of graduate and doctoral students within the total population
- The share of country's market within global services export
- The share of country's market within the import of automobile spare parts and electronic products on a global scale

However, foreign investments' reason of preferring a country to the others is not completely based on the attractiveness of the country. Investor businesses develop strategies depending on the market size, the costs of the production factors, the number of businesses that exist in the area, policies to attract foreign investors implemented by the local authorities [26].

In this context, based on these criteria, under the influence of which factors the foreign direct investments coming to Turkey are realized and how the factors that make the national market attractive have remained since Turkey's European Union membership process were analyzed in the last section of the study.

#### 4. DEVELOPMENT OF TURKISH ECONOMY IN TERMS OF THE ATTRACTIVENESS OF THE PLACE OF INVESTMENT

Turkish economy is among the group of middle income countries between developing countries along with its some unique features. In addition to income status of the countries, it is obvious that other features are taken into consideration by foreign investors. Therefore, it is possible to reveal how the attractiveness of Turkish economy has developed in terms of foreign investors in the last decade by addressing certain criteria set by (CNUCED).

##### 4.1. GDP per capita

Although GDP per capita was accepted as a significant indicator in determining the place of a country in the economic development process once upon a time, it makes sense in conjunction with other criteria in our day. However, today, the size of GDP per capita is the indicative of the size of the volume of potential customers in terms of foreign direct investors who want to produce new goods and services. GDP of Turkey and the development of GDP per capita in the ten-year period are presented in Table 4.

Table 4. GDP in 2004-2014 period (at current prices) and per capita Income (Dollars)

2000	2006	2007	2008	2009	2010	2011	2012	2013	2014	2015
<b>GDP (%)</b>										
6.8	6.9	4.7	0.7	-4.8	9.2	8.8	2.1	4.2	3.0	4.0
<b>Per Capita Income (Dollars)</b>										
4,215	7,727	9,310	10,382	8624	10,112	10,538	10,539	10,800	10,304	9,130

Source: The World Bank WDI, 2016 [27].

Turkish economy is the seventh largest economy in the world's top ten which reached the GDP volume at about 810 billion dollars as of 2014. This feature represents a significant demand size in terms of foreign investors.

GDP which was around 390 billion dollars in 2004 has increased by approximately two-fold at the end of the last ten-year period and reached 810 billion dollars. However, it cannot be said that GDP followed a regular course in the said process. GDP which was increased at the rates of 6-7% until the mid-second millennium has decreased by the effect of the crises which were firstly experienced in Turkey in 2007 and then on a global scale in 2008-2009. It could not maintain its sudden increase following the end of the global crisis in the subsequent process.

##### 4.2. Growth rate of GDP per capita in the last 10 years

Although the size of GDP per capita is the indicative of the size of the volume of potential customers in terms of foreign direct investors who want to produce new goods and services, its mode of development is also important. According to CNUCED, multinational company managers determine their business growth strategy in the future by looking at the past growth trend of the national economy. GDP per capita firstly exceeded the threshold of 10,000 dollars in 2008, made no substantial progress in later years and has been around 10 thousand dollars since the last seven years. GDP per capita growth rates in Turkey between 2004-2014 are presented in Table 5.

Table 5. GDP per capita Growth Rate (%)

2004	2005	2006	2007	2008	2009	2010	2011	2012	2013	2014
7.87	6.98	5.58	3.44	-0.52	-6.05	7.57	6.98	0.30	2.31	1.29

Source: The World Bank WDI, 2016 [28].

The development of GDP per capita of Turkey emerged depending on the course of the GDP during the period. It is seen that Turkish economy was negatively affected by the global economic crisis in 2008 and 2009 and then achieved a growth rhythm but could not maintain at a high level.



This situation faced by Turkey around 10 thousand dollars indicates that the potential demand in the current market would not exhibit a significant increase in the coming years in terms of foreign investors.

### 4.3. The Share of Export within GDP

In general, foreign trade (export and import) has a big share within GDP in small economies. Turkey adopted the development strategy by increasing exports along with the implementation of 24th January 1980 Decisions and made significant progress to remove the barriers to foreign trade. Turkey realized an export of about 160 billion dollars as of 2014, and increasing this figure up to 500 billion dollars is among 2023 targets. The share of export within GDP is presented depending on the years in Table 6.

Table 6. The Share of Goods and Service Export within GDP (%)

2004	2005	2006	2007	2008	2009	2010	2011	2012	2013	2014
23.55	21.85	22.66	22.32	23.90	23.31	21.20	23.97	26.29	25.63	27.88

Source: The World Bank WDI, 2016 [29].

As it is seen in the Table, while the share of export within GDP was 24% in 2004, this rate increased to about 29% at the end of a ten-year period. Turkey's export capacity increased during the period, however it is necessary to ensure an annual export growth rate of over 13% to achieve the export level of 500 billion dollars. On the other hand, when the last 35-year period was evaluated, the share of export within GDP was 14.6%, the share of import was 23.2% [30]. The ratio of export to GDP reached its highest level in 2014 but decreased in 2013 compared to the previous year. However, the performance displayed by export in this way encourages foreign direct investments.

### 4.4. The Number of Fixed-line and Mobile Phone used in the Country

The telecommunications sector has an important place in the development process of a country, and the level of development indicates the presence of modern infrastructure for information and communication in the country. In this context, Table 7 shows the ratios of fixed, mobile phones and internet subscriptions in Turkey.

Table 7. Number of Subscriptions

Years	Fixed Phone	Mobile phone	Internet
2004	19 125 163	34 707 549	1 474 590
2005	18 978 223	43 608 965	2 248 105
2006	18 831 616	52 662 709	3 180 580
2007	18 201 006	61 975 807	4 842 798
2008	17 502 205	65 824 110	5 804 923
2009	16 534 356	62 779 554	8 849 779
2010	16 201 466	61 769 635	14 443 644
2011	15 210 846	65 321 745	22 371 441
2012	13 859 672	67 680 547	27 649 055
2013	13 551 705	69 661 108	32 613 930
2014	12 741 947	71 908 742	39 037 692

Source: D nya, 2016, [31].

As it is seen from the Table, while the mobile phone ownership and internet usage rates over the years increased, the ratio of using fixed lines entered into a downward process.

Today, more than half of Turkey's population has internet access. While about 1.5 million internet subscriptions corresponded to approximately 10% of the population in 2004, the number of subscribers around 40 million corresponded to more than half of Turkey's population as of 2014. Mobile phone entered into Turkey in 1994, and the number of its users is over 70 million in our day. While the internet usage developed depending on the increase in computer usage at the beginning, it has made progress in direct proportion to the investments in mobile phone technology especially smartphones especially in recent years.

The increase in the number of fixed-line and mobile phones in Turkey indicates the baud rate which is considered indispensable by Multinational Companies, technological support for transport services and the country's ability to articulate with the international market.

### 4.5. Energy Consumption per person in the Private Sector

Energy has been one of the key elements of the economic development process, coal constituted the industrialized world's energy source until the end of the nineteenth century, and petroleum maintained its place during the twentieth century. Today, although there is a wider range in terms of ensuring the sustainability of development, the use of electrical energy has an important place. Power consumption also shows the importance of traditional infrastructure except information and communication. Turkey's installed electric power is 75081.48 MW as of 2016, sources such as hydraulic dams and rivers, natural gas, coal and wind constitute the significant portion of this. Table 8 shows Turkey' electricity consumption depending on the years

Table 8. Turkey's Electricity Energy View (GWh).

Years	Consumption	Consumption Growth Rate
2004	150,018	6.3%
2005	160,794	7.2%
2006	174,637	8.6%
2007	190,000	8.8%
2008	196,085	4.3%
2009	194,079	-2.0%
2010	210,434	8.4%
2011	230,306	9.4%
2012	242,370	5.2%
2013	246,357	1.6%
2014	257,220	4.4%

Source: [32].

Turkey meets 65% of its energy needs from abroad, and the electricity consumption has increased by 5.5% on an average in the last 14 years. The increase in electricity consumption indicates that the capacities of businesses producing goods and services in the country have increased, and the introduction of technology into the industry has been accelerated. As it is seen in Table 8, Turkey's energy consumption has made progress with ups and downs depending on the growth rate. The electricity consumption rate provides foreign investors opportunity to interpret Turkey's growth rate in the economic development process.

#### 4.6. Research and Development Expenditures of Public and Private Sectors

The share of research and development expenditures of public and private sectors in the country within GDP gives opportunity to measure the technological capacity of the country. The share allocated by Turkey for the research and development activities within GDP has remained very modest for many years but has gained importance in recent years. The development of R & D expenditures in Turkey is presented in Table 9.

Table 9. The Share of R & D Expenditure within GDP (%)

2004	2005	2006	2007	2008	2009	2010	2011	2012	2013	2014
0.52	0.59	0.58	0.72	0.73	0.85	0.84	0.86	0.92	0.95	1.01

Source: The World Bank, WDI, 2016 [33].

The share of research and development expenditures within GDP in Turkey increased by 18.8% in 2014 compared to the previous year and realized as 17 billion 598 million TL. When we examine Turkey's R & D expenditures, the following three points draw attention as a priority: Firstly, The share of R & D expenditures in GDP has increased by two times since 2004. Secondly, the course of this increase is regular. In other words, the importance attributed to technological developments among the development policies followed has continued to increase even a little in the last decade. Another point is that the share of R & D expenditures within GDP which was 0.95% in 2013 increased to 1.01% in 2014. In 2014, commercial sector realized about 50% of R & D expenditures, higher education sector realized 40% of it and the public sector realized 10% of it (34).

However, Israel that allocated a share of over 4% in this field in the world is taken into account, it appears that Turkey should make further efforts in this direction. Failure to develop new products based on new technologies due to the lack of R & D activities is one of the main problems of Turkey especially in the industrial sector.

#### 4.7. The Share of Goods and Services Import within GDP

The share of goods and services import within GDP of a country shows that country's level of integration with the international production process. The increase and decrease in the capacity of Turkey's economy in this area give information about the increase or decrease in the economic activities in the country as well as the degree of integration with the world economy. The fact that Turkish economy has a structure that needs energy and input of intermediate goods has led to the parallelism between its developments in import volume and the development of economic activities. The share of goods and services import within GDP of Turkey by years is presented in Table 10.

Table 10. The Share of Goods and Services Import within GDP (%)

2004	2005	2006	2007	2008	2009	2010	2011	2012	2013	2014
26.18	25.35	27.58	27.48	28.34	24.42	26.75	32.64	31.45	32.17	32.12

Source: The World Bank, WDI, 2016 [35].

While the share of goods and services import within GDP was about 26% in 2004, it realized around 32% in 2014. In the last ten-year period, the import has increased during the periods in which economic growth was achieved, but it has decreased during the periods in which serious constrictions were experienced. The import has increased from 69 billion dollars to 202 billion dollars and also showed a decrease of around 30 percent due to the global crisis in the 2003-2008 period. Turkey's import realized as 242 billion dollars in 2014. The article in which the imports were made at the most was the mineral fuels and oils with 55 billion dollars, this was followed by boilers, machinery, mechanical appliances and tools (36).

## 4.8. The Share of Foreign Direct Investments within GDP

The size of the share of the foreign direct investments within the GDP of the country indicates the country's capacity to integrate with the global economy, protectiveness of the policies implemented, development of financial markets and the richness of production factors in terms of amount and efficiency. The fact that the share of the foreign direct investments entering into a country within GDP is high naturally motivates the other investors. It is an indicative of the current attraction that arouses the image of the fact that the country is convenient in terms of foreign investments. Table 11 shows the development of the share of the foreign direct investments entering into Turkey within GDP.

Table 11. The share of the foreign direct investments within GDP (% of GDP)

2004	2005	2006	2007	2008	2009	2010	2011	2012	2013	2014
0.710	2.076	3.802	3.406	2.718	1.396	1.244	2.088	1.683	1.504	1.567

Source: The World Bank, WDI, 2016 [37].

The share of the foreign direct investments coming to Turkey within GDP has increased by about two fold in the last decade. The share of the foreign direct investments was 0.71% in 2004 and significantly increased and reached the level of 2% in 2005. The fact that Turkey was declared to be the EU candidate country at the beginning of 2005 increased the availability of Turkey in terms of foreign investors. The share of foreign direct investment within GDP was the highest in 2006, the international capital entering the country led to a substantial increase in the economic growth until 2008 in which global economic crisis was effective. These growth figures also helped increase in the international capital inflows. The share of foreign direct investments within GDP showing a steady increase until 2008 began to decrease as of this year.

## 4.9. Country Risk

Country risk refers to the whole economic, political and social risks that foreign investors may face in the country where they would make the investment. Country risk factor affects all investors evaluating investment opportunities in a foreign country. Country risk is divided into three main categories: These are economic, political and social risk factors [38].

The country risk of a country is calculated according to following formula:

$$\text{Country Risk (x)} = 0.5(\text{Political Risk} + \text{Financial Risk} + \text{Economic Risk})$$

The value of (theoretically) 100 to be calculated from the formula indicates the minimum risk, and (theoretically) 0 indicates the highest risk. As in all risk categories and factors, there is an inverse relationship between the calculated numerical country risk value and country risk level. In other words, the country risk level of a country is low to the extent how high the numerical country risk value calculated for that country is. In contrast, the country risk level of a country is high to the extent how low the numerical country risk value calculated for that country is. The following values are used to scale the countries fallen within the scope of PRS-ICRG (Political Risk Services-International Country Risk Guide) assessment according to their scores they take from the country risk assessment.

Very High Risk: 00.0/49.5

High Risk: 50.0/69.5

Intermediate Risk: 60.0/69.5

Low Risk: 70.0/79.5

Intermediate Risk: 80.0/100 () [39].

Table 12. Country Risk

2004	2005	2006	2007	2008	2009	2010	2011	2012	2013	2014
64.27	67.89	66.37	65.27	63.33	60.89	63.33	62.60	61.89	63.43	60.56

Source: <http://epub.prsgroup.com/the-countrydata-gateway>[40].

According to this calculation, the country risk was 63.62 between the years of 2004-2014 in Turkey. Turkey is in a moderate risk group according to the accounting statement created within the scope of the PRS-ICRG assessment. Like in the development of the foreign direct investments coming to Turkey, the development of country risk was also affected by the developments at the local and global scale. The country risk was reduced at the least in 2005 in which Turkey was declared to be a candidate country to the EU and began to increase as of 2008 in which global financial crisis emerged. In 2014, it approached the high risk level although it was in the moderate risk group by 60.65 level.

## 4.10. The Share of Graduate and Doctoral Students within the Total Population

The share of graduate and doctoral students within the total population provides opportunity to measure the highly qualified labor force potential in the country. The extension of the duration of education in society through the increase in the number of graduate and doctoral students indicates that the qualities of the human capital needed by economy have improved. It indicates the adaptation to the changes in business life, the use of new technologies and the individual improvement in income distribution. In this way, the improvement in human capital increases the country's capacity to produce high-tech goods. The

excessive number of students in higher education institutions constitutes a positive opinion that the labor force needed by foreign companies investing in the country could be met. Table 13 shows the development of the number of graduate students in the last decade.

Table 13. 2004-2014 Number of Graduate Students

Year	Number of Graduate Students	Number of Doctoral Students
2004	21850	2838
2005	23009	2838
2006	27734	2594
2007	15595	4748
2008	28758	3754
2009	33697	4253
2010	42760	4684
2011	27626	4653
2012	25813	4506
2013	36674	4873
2014	41842	4516

Source: [https://istatistik.yok.gov.tr/\[41\]](https://istatistik.yok.gov.tr/[41]).

In Turkey, governments began to allocate greater shares for education from the budget since the 2000s, and this also allowed educational institutions to develop in terms of quality and quantity. The fact that the high school education was increased from three years to four years as of the 2005-2006 academic year also affected the number of those who graduated from undergraduate and graduate education in later years. Since 2007, the increase in the number of universities in Turkey has encouraged graduate education.

#### 4.11. The Share of Country’s Market within Global Services Export

The added-value created by the services sector in GDP and the excessive employment opportunities make great contributions to the development of the national economy through international trade. The development of the manufacturing industry has increased the level of welfare, and the resulting high income level has increased the importance of service sectors such as banking, transportation and health. Therefore, the development of the service sector is unique to developed countries. In the world market, while more developed countries export services, developing countries import services.

Services have been the fastest growing sector in the world economy in the last thirty years. The improvements such as the acceleration of the globalization process and the reduction of barriers to international trade have led to the growth of services sector. The service sectors such as tourism, transport, construction, trade, finance and health generate the highest added value among sectors.

Table 14. Turkey’s Global Services Export (Billion \$)

2004	2005	2006	2007	2008	2009	2010	2011	2012	2013	2014
23.1	27.8	26.0	29.9	36.9	35.6	36.9	40.8	43.2	46.6	50.3

Source: [42].

North America, Western Europe and Asia regions perform the largest portion of world service trade. Turkey's trade in services and consequently exports of services are specific to developing countries and doubled during the period 2004-2014. The export which was 23.1 billion dollars in 2004 regularly increased in the following years, but it was negatively affected by 2009 global crisis. It grew significantly after 2010 and reached to 50.3 billion dollars in 2014. Turkey's exports of services at the end of the 2004-2014 period indicate that Turkey's capacity of integration with the world economy increased as a result of the globalization process, and the diversity in production and specialization in the system also improved. The free trade agreements made with many countries in recent years have played an important role in this.

## 5. CONCLUSION

In Turkey, the import-substitution growth model was put into practice by adopting protectionist foreign trade policies before 1980. The foreign direct investment inflows were also realized as limited because the economic policy implemented during this period was built on a self-enclosed economic structure. 24th January 1980 Decisions also increased foreign direct investments by providing a change of many economic policies in Turkey. While a rapid increase was seen in the global foreign direct investments after 1980, foreign investments increasingly began to enter into developing countries since the 1990s. Turkey could not get the share the desired from the foreign direct investments among developing countries until the end of 2004 despite having a great potential in terms of foreign direct investments. The factors such as inflation, fluctuations in exchange rates, high interest rates, uncertainty in the region, political and economic instability, uncertainty in relations with the European Union and bureaucratic barriers can be included in the reasons of this. However, the fact that Turkey got the status of a candidate country to the European Union in 2005 increased the country's attractiveness for foreign investors.

Various methods are used to measure the attractiveness of the countries in terms of foreign investments. In one of them, based on the indicators determined by the United Nations Conference on Trade and Development (CNUCED), what should the factors that make the national market attractive be in Turkey's effort to attract foreign investments. GDP per capita firstly exceeded the threshold of 10,000 dollars in 2008, made no substantial progress in later years and has been around 10,000 dollars since the last seven years. This situation faced by Turkey indicates that the potential demand in the current market would not exhibit a significant increase in the coming years in terms of foreign investors. The lack of research and development

activities poses a threat for foreign investments because it leads to the problem of being unable to develop new products based on new technologies. When we look at the country risk, it was reduced at the least in 2005 in which Turkey was declared to be a candidate country to the EU and began to increase as of 2008 in which global financial crisis emerged. In 2014, it approached the high risk level although it was in the moderate risk group by 60.65 level. In this context, Turkey will increase its share in the world stock of foreign capital by achieving a more stable economy through solving economic and political problems in terms of attracting more foreign investments. It is thought that the foreign direct investments for Turkey will increase along with the incentive measures to be implemented for foreign direct investments and effective promotional activities as well as the elimination of existing problems and deficiencies.

## REFERENCES

- [1] Cahit Aydemir, Arslan İbrahim ve Uncu Funda, "Doğrudan Yabancı Yatırımların Dünyadaki ve Türkiye'deki Gelişimi", Kocaeli Üniversitesi Sosyal Bilimler Enstitüsü Dergisi 23, 2012, 69-104.
- [2] Nuri, Yavan, Hamdi, Kara, 2003, "Türkiye'de Doğrudan Yabancı Sermaye Yatırımları ve Bölgesel Dağılışı", Coğrafi Bilimler Dergisi, Cilt:1, Sayı: 1, ss:19-42.
- [3] H. Seyidoğlu, Uluslararası Finans, Geliştirilmiş 4.Baskı, Güzem Can yayınları, İstanbul, 2003.
- [4] R. Karluk, Türkiye'de Yabancı Sermaye Yatırımları, İstanbul, İ.T.O., Ekonomik Yayınlar Dizisi, No. 13, 1983, s. 70, 85, 101.
- [5] IMF, Manuel de la balance des paiements et de la position extérieure globale, sixième édition, Washington DC, USA, 2009, 1-372.
- [6] [OECD. « Performances des filiales étrangères dans les pays de l'OCDE », Paris 1994, p15.
- [7] OECD. Définition de référence de l'OCDE des Investissements Directs Internationaux, 2008.
- [8] Resmi Gazete, Doğrudan Yabancı Yatırımlar Kanunu, Kanun No: 4875, Erişim Tarihi: 17 Haziran 2003.
- [9] H. Seyidoğlu, Uluslararası Finans, Geliştirilmiş 4.Baskı, Güzem Can yayınları, İstanbul, 2003.
- [10] Muhsin Kar ve Kara M., "Türkiye'ye Yönelik Sermaye Hareketleri ve Krizler", *Dış Ticaret Dergisi*, Temmuz, Yıl:8, Sayı:29, 2003, 46-80.
- [11] Cahit Aydemir, Arslan İbrahim ve Uncu Funda, "Doğrudan Yabancı Yatırımların Dünyadaki ve Türkiye'deki Gelişimi", Kocaeli Üniversitesi Sosyal Bilimler Enstitüsü Dergisi 23, 2012, 69-104.
- [12] World Bank WDI, 2016.
- [13] World Investment Report, UNCTAD, 2009.
- [14] World Investment Report, UNCTAD, 2014.
- [15] Açıklanmış Sevgin, Ünal Seyfettin, 2008, "Doğrudan Yatırımlar ve Portföy Yatırımları, Global ve Yerel Faktörlerin Türkiye Üzerindeki Göreceli Etkisi", Ekin Basın Yayın Dağıtım.
- [16] M. Emin, Erçakar ve Erdal, Tanas, Karagöl, 2011, "Türkiye'de Doğrudan Yabancı Yatırımlar", SETA Analiz, s.9.
- [17] Harun, Bal ve Göz, Devlet, "Doğrudan Yabancı Sermaye Yatırımları Ve Türkiye", Ç.Ü. Sosyal Bilimler Enstitüsü Dergisi, Cilt 19, Sayı 2, 2010, Sayfa 450 – 467.
- [18] World Bank WDI, 2016
- [19] T.C. Ekonomi Bakanlığı, Uluslar arası Doğrudan Yabancı Yatırımlar 2013 Yılı Raporu, Aralık 2014.
- [20] OECD «L'investissement direct étranger au service du développement. Optimiser les avantages, minimiser les coûts», Paris, 2002, p:60.
- [21] Baud P., Bourgeat S., et Bras C., *Dictionnaire de géographie*, Hatier, Collection initial, 544p, 2003, pp. 137-138 DiMéo G., « Que voulons-nous dire quand nous parlons d'espace ? », in Lévy J., et Lussault M., (sous la direction de), *Logiques de l'espace, espritedeslieuxgéographies à Cerisy*, Paris, Edition Belin, 2000, pp. 37-48.
- [22] Camagni R., « Compétitivité territoriale, milieux locaux et apprentissage collectif : une contre- réflexion critique », *Revue d'Economie Régionale et Urbaine*, N°4, 2002, pp 553-578.
- [23] Benoît Coeuré et Isabelle Rabaud, Attractivité de la France: analyse, perception et mesure, *Économie et Statistique*, 2003, N° 363-364-365.
- [24] Banque de France Bulletin de la Banque de France, N 123, 2004, Mars 1-39.
- [25] Muchielli, J-L., « De nouvelles formes de multinationalisation : les alliances stratégiques », *Problèmes économiques*, n°. 2234, 1991, pp 25-32, Juillet.
- [26] The World Bank WDI, 2016, <http://databank.banquemondiale.org/data/reports.aspx?source=2&series=NY.GDP.PCAP.CD&country=TUR>.
- [27] The World Bank WDI, 2016.
- [28] The World Bank WDI, 2016.
- [29] Dünya 35 Yıl Önce 35 Yıl Sonra Türkiye Ekonomisi, (2015), İstanbul.
- [30] Dünya 35 Yıl Önce 35 Yıl Sonra Türkiye Ekonomisi, 2015, İstanbul.
- [31] [http://www.enerji.gov.tr/Resources/Sites/1/Pages/Sayi\\_11/Sayi\\_11.html#p=20](http://www.enerji.gov.tr/Resources/Sites/1/Pages/Sayi_11/Sayi_11.html#p=20)
- [32] The World Bank, WDI, 2016.
- [33] TÜİK (2015), Haber Bülteni, Sayı:18661, 17 Kasım 2015.
- [34] The World Bank, WDI, 2016.
- [35] Dünya 35 Yıl Önce 35 Yıl Sonra Türkiye Ekonomisi, 2015, İstanbul.
- [36] The World Bank, WDI, 2016.
- [37] Topal, Mehmet, Hanefi ve Gül, Özlem S., (2016), "Ekonomik Risk İle Doğrudan Yabancı Sermaye Yatırımları Arasındaki İlişki: Türkiye Örneği", Gümüşhane Üniversitesi Sosyal Bilimler Enstitüsü Elektronik Dergisi, Cilt:7, Sayı:15, ss:229-247.
- [38] <http://www.mevzuatdergisi.com/2006/06a/01.htm>, (Erişim Tarihi:15.07.2016).
- [39] <http://pub.prsgroup.com/the-countrydata-gateway>, (Erişim Tarihi:10.06.2016).
- [40] <https://istatistik.yok.gov.tr/>.
- [41] <http://www.turob.com>

# Single and Combined Effects of Copper and Nickel on Nitrification Organisms in batch Units

Sukru Aslan<sup>1</sup>

---

## Abstract

Nickel and copper are widely encountered in the industrial wastewaters. The purpose of this batch experimental study was to evaluate single and combined effects of copper and nickel on the nitrification organism activities. Trace amounts of  $\text{Cu}^{2+}$  stimulate the activity of nitrifiers and ARR increased from 0.225 to about 0.5 mg  $\text{NH}_4\text{-N/mg MLSS.day}$  on the first day by elevating  $\text{Cu}^{2+}$  concentrations from zero to 0.05 mg/L, respectively. Nitrification inhibition was not observed during the experimental studies for the studied  $\text{Cu}^{2+}$  concentrations. The ARRs of the nitrification organisms were also found to have decreased by about 16 to 21 fold upon addition of  $\text{Ni}^{2+}$ . Additions of  $\text{Ni}^{2+}$  negatively affect the ammonium oxidation and reaction was not detected during the operations of third day. The ARR values for the studied initial  $\text{Ni}^{2+}$  concentrations were lower than the blank sample. The simultaneous presences of  $\text{Ni}^{2+}$ - $\text{Cu}^{2+}$  negatively affect the activity of nitrification organisms. In order to achieve the same ammonium oxidation level as compared with the blank sample, it needs more reaction times. The experimental results indicated that it is possible to treat industrial wastewater  $\text{Ni}^{2+}$  and  $\text{Cu}^{2+}$  with individually or together. The toxicity of heavy metal could be minimized by increasing the microorganisms in the biological reactor.

**Keywords:** Copper, Nickel, Nitrification

---

## 1. INTRODUCTION

Nitrification involves a sequential conversion of ammonium-nitrogen ( $\text{NH}_4^+\text{-N}$ ) to nitrite-nitrogen ( $\text{NO}_2\text{-N}$ ) and nitrate-nitrogen ( $\text{NO}_3\text{-N}$ ), and the process is carried out by ammonia-oxidizing bacteria (AOB) and nitrite-oxidizing bacteria (NOB), respectively. Because of low growth rate of nitrifying bacteria and their high sensitivity to external factor, nitrification is the controlling step in biological nitrogen removal process [1, 2]. Nitrification is the most sensitive process in the biological wastewater treatment plants, with the autotrophic nitrifying biomass being about 10 times more sensitive than its aerobic heterotrophic part [3]. It has been reported by many researchers that nitrification activity can easily be inhibited by heavy metals and organics [1].

Biological treatment of industrial wastewater presents some difficulties due to its composition. In practice, wastewater treatment plants may be impacted by a stream of shock loading of industrial wastewater containing high concentration of heavy metals and caused deterioration in the performance of biological wastewater treatment systems [1,4]. Metals exist in wastewater in a soluble and particulate form. Settleable fractions of metals and their interactions with various components of water are removed in a primary settling tank. While 40–70% of cadmium, chromium, copper and lead is typically removed, the removal of nickel and manganese is significantly lower (20–30%)[5]. The aquatic life in water bodies receiving treated water include heavy metals is harmed to a great extent. Also, biological waste sludge fertilizers containing heavy metals lead to accumulation of metals in soil and cause harmful effects on vegetation, animals and humans along the food chain [4,6,7].

The presence of heavy metals in the industrial wastewater affects the microorganism activities in the biological wastewater treatment plant. Deterioration of heavy metals on the microorganism are usually overcome by adopting microorganism [4,7–9], applying various reactor types [10], low pollutants loads, and physical-chemical units with an increase in treatment costs [11].

Experimental studies on heavy metals inhibition on the biofilm and suspended growth systems have shown different results. The biofilm system was found to be 2-600 times higher capacity to resist heavy metals stress than suspended growth process. Nitrification organisms in biofilm were more tolerance than organisms in suspended flocs when subjected to shock loads of heavy metals [12]. Lee et al. [12] reported that the biofilm system was able to tolerate a higher total copper concentration (about more than 1.6 times higher) than suspended growth system. Due to the conventional wastewater treatment methods may partially remove heavy metals, residue of heavy metals in the treated waters cause serious problem to the aquatic organisms.

Nickel and copper are widely encountered in the industrial wastewater. Although trace concentrations of copper and nickel have been identified as micronutrients for microorganisms and stimulate the microbial activity, they are both growth inhibitors at high concentrations. Most of the industrial wastewaters usually contain more than one heavy metal. However, most countries have set the maximum acceptable heavy metal concentrations in the water for each heavy metal alone [13]. Nitrifying bacteria

are considered as more susceptible to heavy metals toxicity than heterotrophic microorganisms [14,15]. Compared with Zn, Ni, Cd and other kinds of metals, Cu is considered as more toxic due to it may induce rapid loss of membrane integrity, so longer time is required for natural recovery after inhibition [1]. The molar inhibitory effect of heavy metal toward ammonium oxidation was reported as  $Cu^{2+} > Zn^{2+} > Cd^{2+} > Ni^{2+}$  by Hu et al. [16].

The purpose of this experimental study was to determine single and mixture effects of copper and nickel on the nitrification organisms in a batch unit.

## 2. MATERIALS AND METHODS

### 2.1. Feed wastewater

The synthetic wastewater contained micro and macronutrients were used throughout the experimental studies. Microorganisms, which were drawn from the nitrification unit of domestic wastewater treatment plant, were acclimatized to  $NH_4-N$  with medium solution prepared daily in a tap water. The inoculation conducted in a 5 L mixing and aerated vessel. The inoculation lasted approximately one month for microbial growth with daily replenishment of medium solution.

Table 1. Synthetic wastewater constituents

chemicals	concentrations (mg/L)	chemicals	concentrations (mg/L)
$NH_4Cl$	50-70	$CoCl_2 \cdot 6H_2O$	0.0119
$Na_2EDTA$	4.83	$Na_2MoO_4 \cdot 2H_2O$	0.066
$CuSO_4$	0.0046	$MgSO_4 \cdot 7H_2O$	36.97
$ZnSO_4 \cdot 7H_2O$	0.023	$NaHCO_3$	226
$CaCl_2 \cdot 2H_2O$	36.74	$FeCl_3 \cdot 6H_2O$	0.316
$H_3BO_3$	1.0	$KH_2PO_4$	1920

### 2.2. Batch Experiments

In order to determine the effects of single and mixture of  $Ni^{2+}$  and  $Cu^{2+}$  concentrations on the nitrification bacteria, batch experiments were carried out in 500 mL glass bottles, containing medium solutions and  $NH_4-N$ . After adding acclimated microorganisms into synthetic wastewater, the pH of mixed liquor was adjusted to 7.5 using alkaline solution of 10 N NaOH and bicarbonate buffer was added into the batch unit. The total volume of liquor was 200 mL. The dissolved oxygen concentration was kept over 2.0 mg/L throughout the experimental periods. Experimental studies were performed by varying the concentrations of  $Cu^{2+}$  (0.005–2.0 mg/L) and  $Ni^{2+}$  (0.005–2.0 mg/L) in three batch units for each concentration. Combined effects of heavy metals were investigated at various initial concentration ratios of  $Ni^{2+}/Cu^{2+}$  (I: 0.00/0.00– II: 0.01/0.2– III: 1.0/1.0– IV: 0.5/1.5– V: 2.0/2.0, and VI: 3.0/3.0 mg/L).

In order to compare the results, three blank samples (without heavy metals) were used through all batch procedures. Acclimated nitrification microorganisms about 50 mg/L were included for each batch units.

Batch units were placed on a shaking incubator at 150 rpm and constant temperature of 35 °C. The samples were withdrawn daily from batch units and filtered using 0.45 µm filters. The pH and DO level of solutions were checked daily. Concentrations of  $NH_4-N$ ,  $NO_3-N$ , and  $NO_2-N$  in the clear samples were analysed at least three times.

The batch experiment was completed when the concentrations of  $NH_4-N$  was lower than 0.5 mg/L for each heavy metal concentrations. Concentrations of  $NH_4-N$ ,  $NO_3-N$  and  $NO_2-N$  in the clear samples were measured with the Merck photometer (Nova 60 Model) using analytical kits;  $NH_4-N$  (14752),  $NO_2-N$  (14776) and  $NO_3-N$  (14773). The mixed liquor suspended solids (MLSS) analysis was carried out according to APHA [17].

## 3. RESULTS AND DISCUSSION

When the pH of mixing solution decreased to  $7.0 \pm 0.1$  because of the conversion of  $NH_4-N$  to  $NO_2-N$  and  $NO_3-N$ , pH was increased to about  $7.5 \pm 0.1$  by using alkaline solution in a day. Batch experiments at various single and mixture of  $Ni^{2+}$  and  $Cu^{2+}$  concentrations were carried out to highlight the differences between nitrification rates with and without heavy metals.

### 3.1. Effects of Copper Concentration

Effects of copper concentrations on the ammonium removal rates (ARRs) are presented in Figure 1. Considerable ARR difference between 0.005 and 0.04 mg  $Cu^{2+}/L$  were not observed. Trace amounts of  $Cu^{2+}$  stimulate the activity of nitrifiers and ARR increased from 0.225 to about 0.55 mg  $NH_4-N/mg$  MLSS.day on a first day by elevating  $Cu^{2+}$  concentrations from zero to 0.05 mg/L, respectively. Up to the initial concentration of 0.05 mg/L, nitrification reaction was complete in five days. Further increase the concentrations of  $Cu^{2+}$  from 0.05 mg/L to 2.0 mg/L, the ARR steadily decrease and  $NH_4-N$  oxidation was almost completed in seven days. Due to the residue  $NH_4-N$  concentration in the solution decreases, the ARR value decreased. The lowest ARR value was observed at the concentration of 2.0 mg  $Cu^{2+}/L$ . Nitrification inhibition was not observed during the experimental studies for the studied  $Cu^{2+}$  concentrations. The concentrations of  $NH_4-N$  were lower than 0.5 mg/L for each

Cu<sup>2+</sup> concentration at the end of the experimental

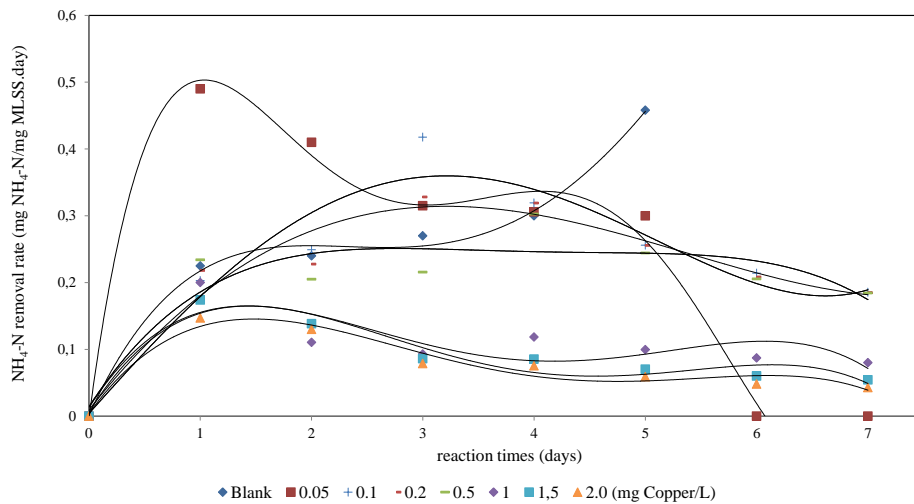

study.

Figure 1. The ARR's variation at different Cu<sup>2+</sup> concentrations.

### 3.2. Effects of Nickel Concentration

As can be seen in Figure 2 that, the NH<sub>4</sub>-N oxidation steadily decreased significantly as the applied Ni<sup>2+</sup> concentration to the nitrifying biomass increased. The AARs of the nitrification organisms was also found to have decreased by about 16 to 21 fold upon addition of Ni<sup>2+</sup>. On the first day of operations, oxidation of NH<sub>4</sub>-N was not detected for the studied concentrations of Ni<sup>2+</sup> while ARR was 0.16 mg NH<sub>4</sub>-N/mg MLSS.day for the blank sample. Additions of Ni<sup>2+</sup> negatively affect the ammonium oxidation. The ARR values for the studied initial Ni<sup>2+</sup> concentrations were lower than the blank sample. Until the third day of reaction, ammonium oxidation was not observed. The ARR values steadily decreased by increasing the initial Ni<sup>2+</sup> concentrations in the solution.

The highest ARR of 0.45 mg NH<sub>4</sub>-N/mg MLSS.day was observed when the nitrification culture was exposed with 0.05 mg Ni<sup>2+</sup>/L.

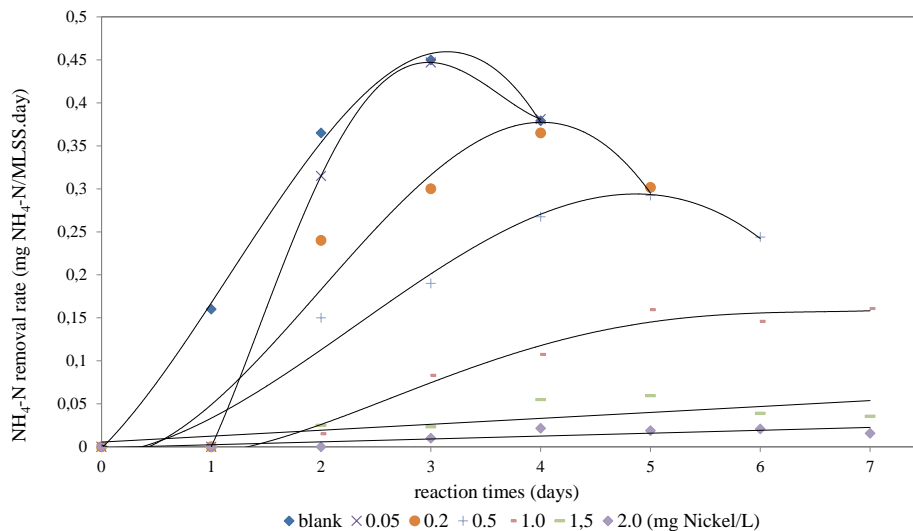

Figure 2. Effects of Ni<sup>2+</sup> on the ARR's.

### 3.3. Effects of Cu<sup>2+</sup> and Ni<sup>2+</sup> mixture on the nitrification process

Batch experiments were carried out with various combinations of Ni<sup>2+</sup>- Cu<sup>2+</sup> for the initial MLSS concentrations of 100 and 200±10 mg/L. The effects of Ni<sup>2+</sup> and Cu<sup>2+</sup> mixture on the ammonium oxidations are depicted in Figure 3 and 4. The simultaneous presences of Ni<sup>2+</sup>- Cu<sup>2+</sup> negatively affect the activity of nitrification organisms. In order to achieve the same ammonium oxidation level as compared with the blank sample, it needs more reaction times. Although no significant difference was found between the removal efficiency of blank and 0.2–0.01 mg Ni<sup>2+</sup>- Cu<sup>2+</sup>/L mixtures, the NH<sub>4</sub>-N removal efficiency



was decreased with increasing of  $\text{Ni}^{2+}$ -  $\text{Cu}^{2+}$  concentrations. The ARR decreased with increasing  $\text{Ni}^{2+}$ -  $\text{Cu}^{2+}$  concentrations from zero to 3.0–3.0 mg/L.

As shown in figures the inhibition level of heavy metal mixture was strongly dependent on the MLSS concentrations. Adding of  $\text{Ni}^{2+}$ -  $\text{Cu}^{2+}$  together resulted in decrease activity of nitrification organisms and  $\text{NH}_4\text{-N}$  oxidation rate was decreased. A decrease of 99.9% to 57% of  $\text{NH}_4\text{-N}$  oxidation was observed when the mixture concentrations were increased from zero to 3.0 mg  $\text{Ni}^{2+}$ / 3.0 mg  $\text{Cu}^{2+}$ /L. Removal efficiencies of  $\text{NH}_4\text{-N}$  increased about 10% with increasing MLSS concentration at all studied  $\text{Ni}^{2+}$ / $\text{Cu}^{2+}$  combinations.

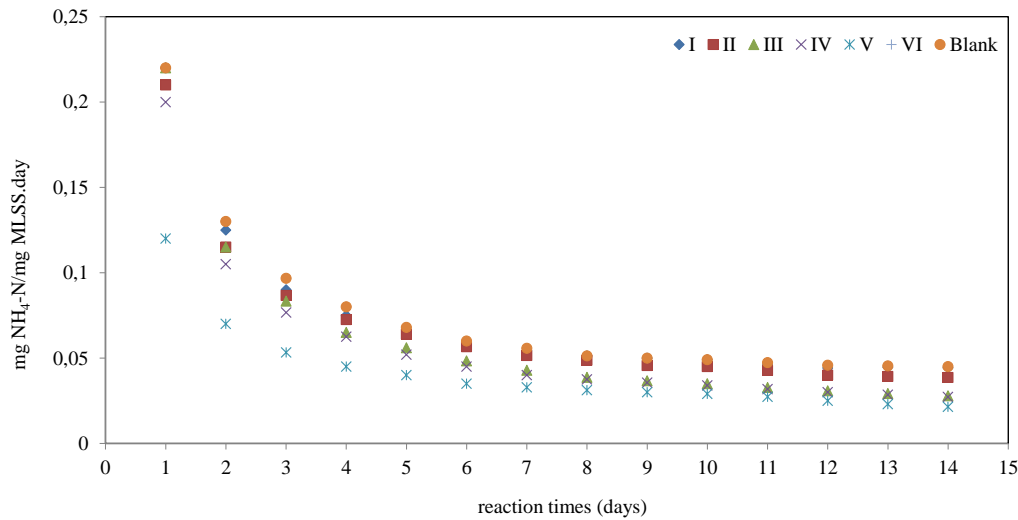
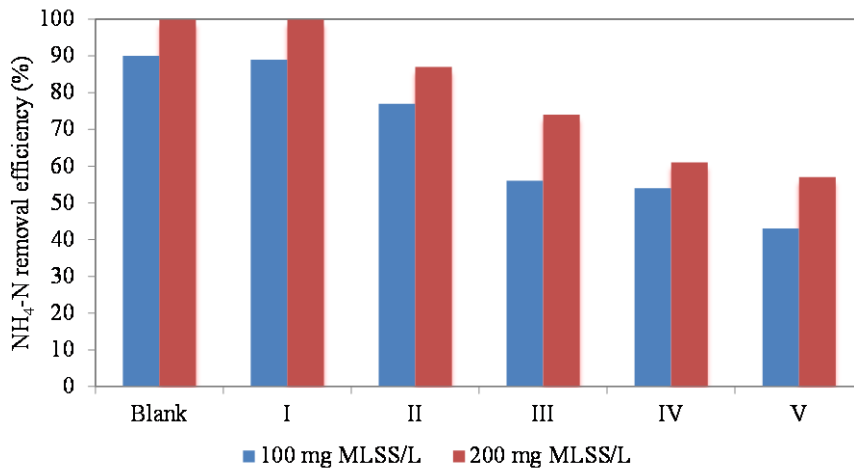

Figure 3. Combined effects of  $\text{Cu}^{2+}$  and  $\text{Ni}^{2+}$  on ARR



#### 4. CONCLUSION

The effect of single and mixtures of  $\text{Cu}^{2+}$  and  $\text{Ni}^{2+}$  on the nitrification process were investigated. When the individual effect of nickel was studied, no nickel concentration causing any stimulation was observed, as happened with 0.05 mg/L of  $\text{Cu}^{2+}$ . The toxic inhibitory effect of nickel was found to be considerably higher than that of copper for the studied concentrations in the experiments. Combinations of  $\text{Cu}^{2+}$  and  $\text{Ni}^{2+}$  introduced to the wastewater might produce serious upsets in the nitrification process. Results showed that the toxicity of heavy metal could be minimized by increasing the microorganisms in the biological reactor

#### ACKNOWLEDGMENT

This work is supported by the Scientific Research Project Fund of Cumhuriyet University under the project number M-395 and M-421, Sivas, Turkey.

#### REFERENCES

- [1]. Wang, Y., Zhao, Y., Ji, M., and Zhai, H., "Nitrification recovery behavior by bio-accelerators in copper-inhibited activated sludge system" *Bioresource Technology*, 192, 748–755, 2015.
- [2]. Wang, Y., Ji, M., Zhao, Y., and Zhai, H., "Recovery of nitrification in cadmium-inhibited activated sludge system by bio-accelerators" *Bioresource Technology*, 200, 812–819, 2016.
- [3]. Juliastuti, S.R., Baeyens, J., and Creemers, C., "Inhibition of Nitrification by Heavy Metals and Organic Compounds: The ISO 9509 Test" *Environmental Engineering Science*, 20, 2, 2003.
- [4]. Ozbelge, T.A., Ozbelge, H.O., and Altınten, P. "Effect of acclimatization of microorganisms to heavy metals on the performance of activated sludge process" *Journal of Hazardous Materials*, 142, 332–339, 2007.
- [5]. Lipczynska-Kochany, E. and Kochany, J., "Effect of humate on biological treatment of wastewater containing heavy metals" *Chemosphere*, 77, 279–284, 2009.
- [6]. Metzner, A.V., "Removing soluble metals from wastewater" *Water Sewage Works*, 124, 98–101, 1977.
- [7]. Bagby, M. M. and Sherrard, J. H., "Combined effects of cadmium and nickel on the activated sludge process", *Journal Water Pollution Control Federation*, 53, 11, 1609-1619, 1981.
- [8]. Beyenal, N.Y., Ozbelge T.A., and Ozbelge H.O., "Combined Effects of Cu<sup>2+</sup> and Zn<sup>2+</sup> on Activated Sludge Process" *Water Research*, 31, 4, 699-704, 1997.
- [9]. Yetis, U., Demirer, G.N., and Gokcay, C.F. "Effect of Chromium (VI) on the Biomass Yield of Activated Sludge" *Enzyme Microbial Technology*, 25, 48–54, 1999.
- [10]. Carucci, A., Chiavola, A., Majone, M., and Rolle, E. "Treatment of tannery wastewater in a sequencing batch reactor" *Water Science and Technology*, 40, 253–259, 1999.
- [11]. Farabegoli, G., Carucci, A., Majone, M., and Rolle, E. "Biological treatment of tannery wastewater in the presence of chromium" *Journal of Environmental Management*, 71, 345–349, 2004.
- [12]. Lee, Y.W., Tian, Q., Ong, S. K., Sato, C., and Chung, J. "Inhibitory effects of copper on nitrifying bacteria in suspended and attached growth reactors" *Water Air Soil Pollution*, 203, 17–27, 2009.
- [13]. Gikas, P. "[Single and combined effects of nickel \(Ni\(II\)\) and cobalt \(Co\(II\)\) ions on activated sludge and on other aerobic microorganisms](#)" *Journal of Hazardous Materials*, 159, (2–3), 187–203, 2008.
- [14]. Campos, J.L., Garrido-Fernandez, J.M., Mendez, R., and Lema, J.M. "Nitrification at high Ammonia Loading Rates in an Activated Sludge Unit" *Bioresource Technology*, 68, 141-148, 1999.
- [15]. Semerci, N. and Cecen, F., "Importance of the Zn Species in batch nitrification systems" *Water Practice Technology*, 1 (3), 2006.
- [16]. Hu, Z., Domenicograsso, K., and Smets, B., "Impact of Metal Sorption and Internalization on Nitrification Inhibition" *Environmental Science Technology*, 37, 728-734, 2003.
- [17]. APHA, (1998) 20<sup>th</sup> ed. American Public Health Association/American Water Works Association/Water Environment Federation, Washington, DC, USA.

# The Effects of Building Materials on Building Biology and the Resultant Air Quality

Nil Kokulu<sup>1</sup>, Seden Acun Ozgunler<sup>2</sup>

---

## Abstract

*The basic need of a human being is to lead a healthy life. Since people spend 90% of their life indoors, the main function of a building should be providing a healthy environment for its occupants. A building should meet its occupants' biological, psychological, social needs through its quality indicators related to the outdoor-indoor environmental characteristics. Buildings, which are designed, constructed and presented in a health supporting condition, may lose their healthiness over time. The reason for this is that the quality indicators' may change over time (aging of the building and the user) and circumstances (function, environmental characteristics, characteristics of the user). Building Biology can be defined as the study of the relationships between people and their constructed environment. It is a science that leads to natural healthy ecological buildings that exist in harmony with the planetary environment. The main aspects of building biology are interior climate, heat and moisture comfort, air quality, radioactivity, electro-climatic pollution, acoustic violence and natural lighting conditions and its effects.*

*According to the studies, 65% of our buildings are polluted, sometimes as much as five to ten times higher than outdoor city pollution. The harmful gases, volatile organic compounds, particulate matter, lead, asbestos and dust have been receiving considerable interest in indoor air field studies because of their high emission rates from materials used in indoor environments. They can cause diseases such as cancer, asthma, allergic reactions, pulmonary fibrosis and many more.*

*In this study; the definition of building biology, types and sources of indoor air pollutants and the impact of materials on indoor environment and human health are discussed in detail.*

**Keywords:** *building biology, building materials, human health, indoor air quality.*

---

## 1. INTRODUCTION

People, by nature, tend to create a shelter by using materials readily available to them. With the help of technology and the expansion of the available resources, societies developing and gaining more information day by day, have been constructing more practical structures but sometimes they are more threatening also to human health. Because of the improved industry, rise of the economic inadequacy and the awareness of the work variety, villagers who have fewer materials and opportunity moving to the bigger cities, have enabled the rapid growth of the urban areas. Population growth and industrial development have caused a decline in the quality of the urban environment. Due to industrial development, natural materials have simulated using artificial materials. Biological structures that are made of artificial materials have begun to adversely affect human health.

Indoor air quality has a significant influence on the main purpose of a building which otherwise is providing a comfortable environment that meets the need of human beings [1]. Human and environmentally friendly buildings, should be able to take part in the ecological cycle of the local topography and should not stand as a foreign object, instead it should reflect its locale. In this respect, the building has to be constructed with the natural materials that were provided from where building will stand. In order to design a healthy building, the users have to take part in every stage of the construction. In today's world, people still tend to buy psychologically, sociologically and biologically unhealthy materials which adversely affect their health.

Researches proved that indoor air quality is polluted by the harmful materials used in construction. On this matter "Sick Building Syndrome (SBS)", resulting from the building lived in, is mainly caused by poor indoor air quality. It is possible to avoid the pollution by reviewing material sources. The concept of Building Biology arises at this point. With the help of this concept, the principle of human guides himself to nature not the vice-versa has become important. [2].

The aim of this paper is to describe the definition of the Building Biology, the effects of building materials on indoor air quality, human health, and to determine the points to take into consideration when selecting materials.

---

<sup>1</sup>Corresponding author: Istanbul Technical University, Faculty of Architecture, Department of Environmental Control and Building Biology, Taşkişla Cad., 34437 Istanbul, Turkey, [nilkokulu@gmail.com](mailto:nilkokulu@gmail.com)

<sup>2</sup>Istanbul Technical University, Faculty of Architecture, Taşkişla Cad., 34437 Istanbul, Turkey, [acused@itu.edu.tr](mailto:acused@itu.edu.tr)

## 2. THE DEFINITION OF BUILDING BIOLOGY

Every living creature adapts to its own environment and is affected by it in a good or a bad way. All mammals start life in a womb that is their first environment. This environment has positive effects to sustain life features and at the same time it would damage the child if negative traits were present. Environmental conditions are very important for people to live a healthy life. The relationship of a building with the human and the environmental structures can be considered as a micro-ecosystem. In this micro-ecosystem, the building is in a harmonious relationship with people and nature. Therefore, the building must be designed to be environmentally friendly and protect human health [2].

Since we spend a large part of our lives in buildings, it is not enough to focus only on heat insulation, water insulation, acoustical conditions and so on for comfortable conditions. Building and interior elements must be in harmony with human health and nature. In the light of this, a science called "Building Biology" has developed as a new branch [3].

The first studies in Turkey on building biology were initiated in 1989 by And Akman. According to him, building biology has adopted convenience of technological values to ecosystem and the human nature (bio) in structure (building) and spiritual values in a cultural way (logi) as the principles [2] (Table 1).

Table 2 The semantic expansion of building biology [2].

<b>Building</b>	<b>Bio (Biyos)</b>	<b>Logi (Logos)</b>
skin, home, nest, motherland, settlement, habit, security, welfare, shelter, shell, protection	vitality, life, natural, guidance, habitat	attitude, creativity, power, incarnation, modularity, the world order, universe, holism, integrity

Here are a few definitions for the science of Building Biology;

Ersoy (1994) describes the building biology as;

"It is the science which works on the harmony of the human health and the nature of which interior conditions must have in the building [3]".

Akman (1990) describes the building biology as;

"It is the science from the researches that it effects on occupant's physical, mental and spiritual health of the built environment and the alternative structures in this direction [4]".

Güler (2005) describes the building biology as;

"Arising from poor quality materials and unqualified implementation, It is a science that examines the causes and the effects of buildings, spaces, building materials and equipments on people [5]"

Based on all these information, building biology can be defined as: Building Biology is a science that eliminates the negativity which will affect human life by connecting people with building and its environment, produces and controls the formation and usage of the building which will direct the human health [6].

## 3. HOW BUILDING MATERIALS EFFECT THE IN DOOR AIR QUALITY AND THE HUMAN HEALTH

The air in nature is continually being renewed and refreshed. Fresh air physiologically contains the proper amount of colibacillus, and ions that are in optimal proportions. It does not contain harmful gasses and its scent doesn't annoy [7]. Most of the chemicals in building materials, furniture, paints and polishes and most of the cleaning materials used indoor for cleaning purposes spread harmful gasses year by year. Adequate ventilation of closed space helps to eliminate air pollution spreading from the materials. It is estimated (thought) that a human being needs 30/ m<sup>3</sup>/hour of fresh air in order to feel comfortable. The above value (30/ m<sup>3</sup>/hour per person) would be optimal if using natural building materials, whereas when using plastic materials, the value goes up to, 60/ m<sup>3</sup>/hour per person [3]. The Union of American Allergists stated that occurrence and spreading of an illness is 50 percent caused by indoor pollution; and 1/6 of patients, complaining from allergies consult doctors for medical treatment. These kinds of problems are mostly caused by unfavorable indoor air quality, they present as allergies, muscle pains, fatigue, respiratory tract infections even toxicity health problems [8; 9].

Problems of indoor air quality are recognized as important risk factors for human health in both low and middle countries. A report prepared by World Health Organisation (WHO) in 2012 shows the death percentage due to indoor air pollutants in some countries (Figure 1).

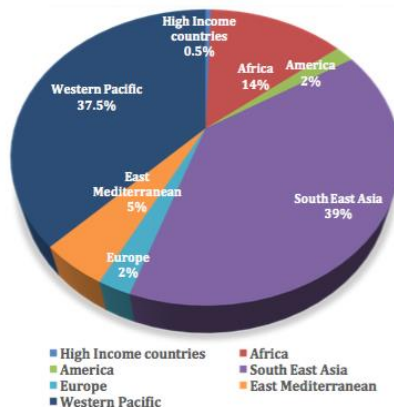

Figure 3 Death percentage due to indoor air pollution [10]

According to the research by Masters in 1998, people are affected by indoor air pollution caused by building materials; through inhalation, digestion, and the skin. The indoor air pollutants differ due to physical conditions indoors, the design of the buildings, environmental features that exist in the building and also the behavior of the people living there [11]. Research has shown that, healthy circumstances cannot be maintained in buildings that are newly developed or improved; furthermore, it is reported that 30% of the buildings caused “Sick Building Syndrome” [12]. In addition, it is estimated that about half of all buildings (structures) in the United States have indoor environmental drawbacks. [13].

The main air pollutants affecting air quality in buildings are:

1. Harmful gases (Carbon dioxide, Carbon monoxide, Nitrogen oxides, Ozone, Sulphur oxides, Radon)
2. Bioaerosols (Biological Contaminants)
3. Volatile Organic Compounds (Formaldehyde, Benzene, Chloroform, Toluene, Xylene, Pesticides)
4. Particulate Matter
5. Lead
6. Asbestos
7. Dust
8. Odors

Some of the hazardous effects of these substances on health are known; however, many have likely not yet been documented. Indoor air pollutants’ potential sources and effects on people’s health are shown in Table 2.

Table 2: Indoor air pollutant’s potential sources and their impact on human health [1; 14; 15; 16; 17; 18; 19; 20; 21]

Pollutant	Potential Source	Impact on Human Health
<b>Carbon dioxide</b>	Gas boilers, oil boilers, chimneys, HVAC system	Respiratory stimulant effects, reducing the ability to perform strenuous tasks in humans, calcification in the kidney and pulmonary alveoli, muscle pain, fainting, spasm, death
<b>Carbon monoxide</b>	Water heaters, ovens, wood heaters, chimneys, HVAC system	Strengthens the drowning effects for the patients, reducing the workforce for healthy men, headaches, eye shrinkage, faults in the cardiovascular system, electrocardiographic abnormalities, strengthening the heart-lung mismatch on patients, nausea, fainting, death
<b>Nitrogen oxides</b>	Non-ventilated gas stoves, kerosene heaters, chimneys	Reductions in lung function in asthmatics, affecting lung functions of children and adults, preclusion of the smell, airway complaints
<b>Ozone</b>	The combustion of sulfur-containing fuels, office sets, photocopy machines, HVAC system, air cleaning appliances	Reduction of the oxygen pressure on the artery, changes in lung function parameters, decrease of the night view
<b>Sulphur oxides</b>	Stoves, the combustion of coal and fuel, HVAC system	Increased respiratory symptoms in patients with chronic bronchitis, increase in the frequency of asthma attacks, negative effect on respiratory systems
<b>Radon</b>	Building materials based on soil and rock, underground waters	Lung cancer
<b>Bioaerosols</b>	Pillows, beds, curtains, carpets, dust, wet or moist materials, draped armchairs, walls and floors of the basement, window frames, washing machine and the back side, kitchen, wallpaper, HVAC systems, upholstery	Infectious diseases, allergic reactions; toxic effects.
<b>Formaldehyde</b>	Particleboard, fibre board, plywood	Allergic reactions, lacrimation, nose and throat irritation, contagion of the smell, asthma

		attacks, drowsiness, lack of energy, memory loss, sneezing, skin rash, cough, chest tightness, chest pressure, head pressure, heartthrob, pulmonary edema, and infection, death
<b>Benzene</b>	Dissolvents, paints, varnishing, printers pastes including latex, water based adhesives, wood panels, carpets, vinyl floor coverings, fabric cleaners, foamed plastics and synthetics	Short-term inhalation results in loss of consciousness, drowsiness, dizziness, headache, skin and respiratory tract irritation; red blood cells as a result of long-term inhalation, aplastic anemia, leukemia and other blood diseases.
<b>Chloroform</b>	Coatings, adhesives	Affects the circulatory, immune, fertility system, blood diseases, cancer, activity on liver, kidney, stomach and intestinal, death
<b>Toluene</b>	Upholstery (vinyl, wood, carpet), office sets, wall and ceiling coverings, furniture, treated timber, dissolvents and adhesives	lung injury, asthma, eye diseases, insomnia and incoordination
<b>Xylene</b>	Upholstery (vinyl, wood, carpet), office sets, wall and ceiling coverings, furniture, treated timber, dissolvents and adhesives	Lung plunger, renal impairment, mucous membrane irritation, circulatory disorder, headache, nausea, fatigue and lethargy
<b>Pesticides</b>	Wallpaper adhesives, paints, and plasters	Poisoning and sensitizing the brain and the liver
<b>Lead</b>	Paints based on lead	Effect on kidney, nervous system and the blood cells
<b>Asbestos</b>	Pipe and boiler insulation, ceiling and the floor boards, decorative sprays, roof coverings, wall coverings	Mezotelis

According to Table 2; indoor air quality is polluted by materials such as paints, wood panels, carpets and plastics we use in everyday life. Health problems like allergic reactions and cancer occur by using artificial materials. adhesives, polishes and protectors.

#### 4. MATERIAL SELECTION ON BUILDING BIOLOGY

It is important to consider biological aspects when selecting building materials. According to Akman, apart from the materials that differs with climate, 30-40 % organic materials (i.e wood, straw, reed) and 60-70% inorganic materials (i.e brick, tile, natural stone, lime) were used at buildings. Nowadays, especially in modern buildings in larger cities, materials used are 90-100 % artificial, foreign to nature, life and to human metabolism. Indoor air pollution, caused by building materials, is due to material structure, application, usage, and having completed its service life. Therefore, at the time of selection, building materials should be described with all features, positive and negative, so that those choosing can minimize harm to the environment throughout the life cycle of the material. This creates an environment that would least threaten human health.

The selection of materials considered for Building Biology should include the following:

- Durable materials
- Biologically demountable materials
- Materials that reduce energy consumption in their application,
- Formation of low - energy materials
- Materials with the least environmental impact
- Materials from the manufacturers that were taken by material recycling programmes
- Materials that reduce the urban heat island effect
- Certified wood
- Materials that emit very low levels of radiation
- Materials produced and used in local topography
- Materials that reduces water consumption in their application
- Materials with the least water pollution impact
- Materials produced from renewable sources
- Reprocessed materials
- Minimum processed future materials
- Materials that can be recycled or have the potential to be recycled
- Materials that do not contain harmful chemicals as pigments, thickeners, fire retardant [22; 23; 24; 25]

Unfortunately, these criteria are not known well enough to be applied. Research about ecological buildings has been made by Krusche and friends in 1982 for the classification of building materials. They specified materials which must be used and which mustn't be used.

Materials that must be used are:

- Pressed brick and wood as facade materials
- Wood, brick and adobe as wall structure materials
- Wallpaper, natural and artificial wood panels, wainscot, surface fabric coatings
- Stone, wood and linoleum as floor covering
- Wool and linen carpets
- Wood wool and chaff as insulation materials
- Natural paints such as water based oil paints.

Materials that must not be used are;

- Tuile
- Aluminium, zinc, lead, sheet metal, cement, mineral based materials like asbestos boards
- Synthetic carpets
- Fibreglass, expanded perlite, polystyrene foam, synthetic foam
- Synthetic resin based paints.

## 5.CONCLUSIONS

It is essential to provide basic principles so that humans can continue their vital activities and maintain optimal health. These basic principles which occur with the help of Building Biology(biological, psychological and by meeting social needs) accelerate the process of creating a positive environment for people. To create livable environments on behalf of future generations, using material that not only looks beautiful but also is environmentally friendly, durable, recyclable, energy-efficient, and economical, thoughtful material selection is necessary. Studies have proved that unnatural environmental conditions created by unhealthy building materials spread various pollutants threatening human health. These contaminants which disrupt indoor air quality causing "Sick Building Syndrome", must be considered beginning with the design of the structure and in order to maintain the occupants' health.

To create better environments and protect human health;

- Enhance the awareness of Building Biology by means of presentations, media, books, leaflets etc..
- It should be made compulsory by all the governments for the production of environmentally friendly materials.
- People should be encouraged to use natural materials as much as possible.
- Checklists about the specifications of the building materials and their effects should be made by the people (users, architects, producers, inspectors, advisers, etc.) who plays part in the design of the building.
- Every material has to have material data sheets ( MSDS) and should be clearly understood and accessible.

## ACKNOWLEDGEMENT

The completion of this study could not have been possible without the expertise of Seden Acun Özgünler, my beloved thesis adviser. I would like to thank her for supporting and enlightening me on what I really want. I am also thankful to Vecdi Kokulu who provided language help during the research and Tom and Nancy Austin for proofreading.

Last but not least, I would like to thank my parents and my sister for allowing me to realize my own potential. All the support they have provided me over the years was the greatest gift anyone has ever given me.

## REFERENCES

- [1] M. Vural, "Yapı içi hava niteliği risk süreci modeli belirlenmesi", Phd, İstanbul: Yıldız Technical University, Institute of Science, İstanbul, 2004.
- [2] A. Akman, "Neden yapıda biyoloji". *Ekolojik Yapı ve Yerleşim*, vol 15, pp 64-67, 2013.
- [3] H. Y. Ersoy, "Yapı biyolojisi; insan, yapı ve çevre", *Yapı*, vol 146, pp 56-61, 1994.
- [4] A. Akman, *Yapı Biyolojisi – Yapı Ekolojisi ve Yapıların İnsan Sağlığı Üzerindeki Etkilerini Ortaya Koyan Biyoklimatik – Diyagnostik Bir Araştırma*. Teramed, İstanbul, 1990.
- [5] Ç. Güler, "Yapı biyolojisinin kuramsal temelleri", M. Thesis, Fırat University, Institute of Science, Department of Building Major, Elazığ, 2005.
- [6] A. Öztürk. and A. Balanlı, "Yapı biyolojisi kavram ve kapsam", *Sağlıklı Kentler ve İnşaat Mühendisliği*, TMMOB İnşaat Mühendisleri Odası İzmir Şubesi, İzmir, 20-21 October, 1995, pp 135-140.
- [7] A. Akman, "Kayseri yöresi geleneksel kırsal yapı dokusunun insan sağlığına etkileri bakımından incelenmesi", Phd.
- [8] M. S. Vural, and A. Balanlı, "Yapı ürünü kaynaklı iç hava kirliliği ve risk değerlendirmede ön araştırma", *Megaron YTÜ Mimarlık Fakültesi*, vol 1, 2005.
- [9] I. Myers and R. L. Maynard, "Polluted air-outdoors and indoors", *Occupational Medicine*, vol 55, pp 432-438, 2005.
- [10] 2012, Institute for Competitiveness, WHO, <http://competitiveness.in/2015/09/15/death-percentage-due-household-air-pollution/>
- [11] E. Yurtseven, "İstanbul üniversitesi cerrahpaşa tıp fakültesi hastanesi hava kalitesi yönetimi", *1. Ulusal Sağlık Kuruluşları Çevre Yönetim Sempozyumu*, İstanbul, 29-30 November, 2012.
- [12] D. M. Roodman and N. Lenssen, "A building revolution: how ecology and health concerns are transforming construction", *Worldwatch Paper*, vol 124, Worldwatch Institute, March 1995.

- [13] CIB (International Council for Research and Innovation in Building and Construction), "Agenda 21 on sustainable construction", CIB Report Publication 237, Rotterdam, Netherlands, 1999.
- [14] ASHRAE, *ASHRAE Handbook- Fundamentals*. Atlanta, 2005.
- [15] H. Bulgurcu, Havalandırma ve İç Hava Kalitesi. [http://deneysan.com/Content/images/documents/havalandirma-1\\_46167331.pdf](http://deneysan.com/Content/images/documents/havalandirma-1_46167331.pdf)
- [16] Çevre Bakanlığı, *Çevre Kirliliği Kitabı*. Ankara, 1998.
- [17] M. Öztürk, "Şehir içi bölgelerde hava kirliliğinin sağlık üzerine etkileri, çevre ve orman bakanlığı" Ankara, 2005.
- [18] EPA (United States Environmental Protection Agency), Radiation: Risks and Realities-Natural Radiation, <http://www.epa.gov/radiation/rpage/rpage3.html>, 2000.
- [19] H., T. Şahin,, M. Filiz, A. İ. Kaya, A., Sütçü, P. Usta, M. Çiçekler, C. Bozkurt, "Ahşap esaslı malzemelerden formaldehit emisyonu ve etkileri", *Laminart*, vol 73, pp 116-119, April-May 2011.
- [20] A. Balanlı, M. S. Vural, and T. Taygun, "Yapı ürünlerindeki formaldehitin yapı biyolojisi açısından irdelenmesi", *3. Ulusal Yapı Malzemesi Kongresi*, 2006, pp 430-438.
- [21] USEPA, "2000 Toxics Release Inventory (TRI) Public Data Release Report Executive Summary", Office of Environmental Information, Washington, D.C, 2002.
- [22] D. Anink, *Handbook of Sustainable Building: An Environmental Preference Method for Selection of Materials for Use in Construction and Refurbishment*, James & James, London, 1996.
- [23] T. Bhamra, V. Lofthouse, *Design For Sustainability : A Practical Approach*, Gower Publishing Limited, England, 2007.
- [24] J. F. Kennedy, *Building Without Borders : Sustainable Construction For The Global Village*, New Society Publishers, 2004.
- [25] J. F. McLennan, *The Philosophy Of Sustainable Design : The Future Of Architecture*, Ecotone, Canada, 2004.

## BIOGRAPHY



Nil Kokulu is an architect who graduated from Bahcesehir University with a bachelor degree in 2013. The degree included an internship in Montevarchi in Italy for a year. The internship project was shown in Venice Biennale. She worked with Polimeks Construction, Yalın Tan and Partners and Tabanlıoğlu Architects where she took part in big projects such as Eskişehir Bademlik Rixos Hotel, Astana Railway Station, Yenitepe Kadıköy Urban Transformation project. Even through, these experiences, her dream was to learn more about the specifications of building materials. While working for Tabanlıoğlu Architects, she entered İstanbul Technical University and met with her thesis adviser, Seden Acun Özgünler who affects her life positively. She will graduate with a Master's Degree of 'Material Selection on Building Biology' in December 2016.

Address: M. Kasapoğlu Cad. Yakamoz Sitesi, No:58/9 Antalya

Phone Number: +90 542 284 92 64

E-mail: nilkokulu@gmail.com



# Data rate measures for 4G networks in Albania

*Julian Imami<sup>1</sup>*

---

## Abstract

*Companies of mobile telephony operate in a highly competitive market. Subscribers, with the possibilities given to them to change the operators, can easily change network based on the services offered to them. Due to this, all mobile operators which aim to grow and establish a better position in the market they operate, are involved permanently in offering better services for their current and pretended subscribers.*

*The quality, the speed and all related values to data offered are fields which the operators in Albania aim to improve. From 4 Mobile Operators in Albania, 3 of them offer 4G LTE data service.*

*This paper focus on measuring how real the data values declared by them are and how good is the quality of 4G LTE service offered. Through this paper we will discuss over different measures made in Tirana city related to rate fluctuation of uplink and downlink throughput of data service. The measures are located in 6 different points in Tirana city, which are chosen based on the traffic rate. Measures (made at the same day and time for all the operators in order to have equality) are realized through a Huawei LTE modem for FTP DL/UL.*

**Keywords:** 4G LTE, Data Throughput, LTE modem

---

## 1. INTRODUCTION

The mobile telecommunication industry operate in a high speed growing market. This is a dynamic area in which every operator needs to stay up to date in order to be competitive and to get as soon as possible competitive advantages. Based on the services offered in this industry the one which has had the most frenetic growth and is growing more and more is the data service offered to subscribers. The data network is developing with galloping steps. In a short period of time we have been witness of going through 2G to 3G and now days Albanian operators offer 4G LTE technology.

LTE is a network with only eNode-B nodes, and it can be considered as a changed core network that has replaced GPRS core network made from the GGSN (Gateway GPRS support node) and SGSN (Serving GPRS support node) nodes.

In this core network we face some other nodes like: MME (Mobility Management Entity), HSS (Home Subscriber Server), SGW (Serving Gateway) etc. In Albania the number of internet users and specifically of 4G LTE users has seen a growth from year to year. Related to the number of internet users in mobile phone, it varies from 45% to 50% of population. In Albania there are 4 mobile operators, from which 3 of them offer 4G.

This paper will concener in the upload and download speed offered from the operators. The tools used for the drive test and the further analysis are as per below:

- TEMS Investigation Software
- Two Samsung Galaxy Note 4 mobile phones, 1 x PCTelscanner, 3 x Huawei LTE modem.
- One Laptop Computer, 1 x GPS, TemsDiscovery Tool, ActixTool

### 1.1. Test Method

- Huawei LTE modem used for FTP DL/UL in six different points in Tirana City with same radio conditions for 3 operators.
- One scanner for LTE network.

USB LTE stick E3272 [1] supports the maximum speed 150 Mbit/s downlink and 50 Mbit/s in the uplink, which corresponds to LTE category. For its use are needed some drivers (which installs on the first usage), for further connections there are not needed further actions.

Huawei E3272 can use worldwide:

- LTE: 800/900/1800/2100/2600 MHz
- UMTS: 900/2100 MHz
- GSM: 850/900/1800/1900 MHz

---

<sup>1</sup> Julian Imami UPT University Department of Telecommunication Engineering Tirana, Albania [julianimami@hotmail.com](mailto:julianimami@hotmail.com)

It can be used with both Windows and Mac OS like Windows system from XP (Service Pack 3), Windows Vista (Service Pack 1), to Windows 7 or Windows 8, alternatively you can of course also use it with MAC OS.

We have used TEMS Investigation [2] because it supports the most part of recent technologies, thus it has been seen as the most appropriate tool for this kind of test. It is relatively easy to be used since it can be positioned by the device that was used to make the measure and then with very simplicity the test maker could make the test. It can be used for specific and updated to customer need scenarios like in our case.

## 2.RESULTS

All measures are made in 45 points in the city of Tirana. 45 points are grouped in 5 main divisions. Grouping is realized according to similarities of the measure points. So the results are expressed analyzed and grouped in the following main divisions: Coffee area, Hotel, Residential Area, Shopping Mall and University. All the measures are made in Tirana city, which is the capital city of Albania. Tirana [3] has a population of 811,649 persons with a density of about 450/km<sup>2</sup>. Tirana is the most populated area in Albania where the migration process is very high.

Measures are made during 1 week and take in consideration only 3 (Eagle Mobile, Vodafone, AMC) from the 4 mobile operators because only 3 of them offers 4G [4].

The below graph shows the information related to Ping Avg.:

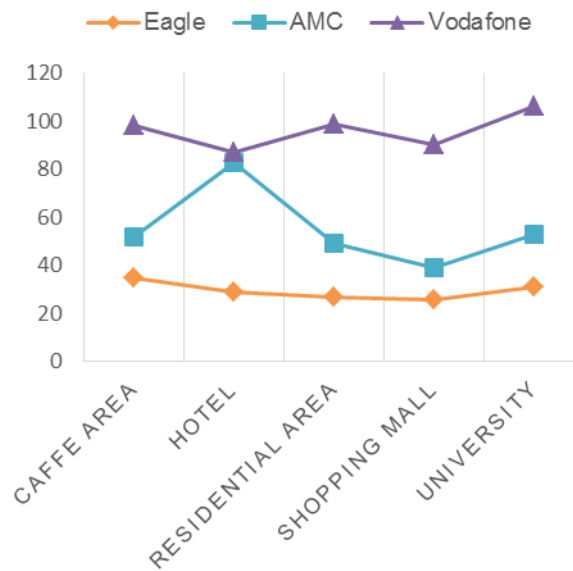

Figure 1. Ping avg.

From the graph we can easily see that the best connection with the antennas belongs for Vodafone operator, then it comes AMC and the last is Eagle Mobile.

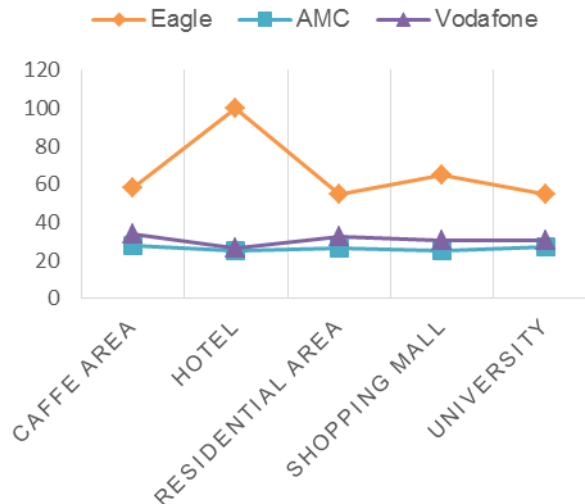

Figure 2. Information related to dl max throughput (Mbit/s)

Related to DL it is seen that the Max Throughput is in the Hotel area and belongs to Eagle Mobile operator. It has a value of 99.93 Mbit/s.

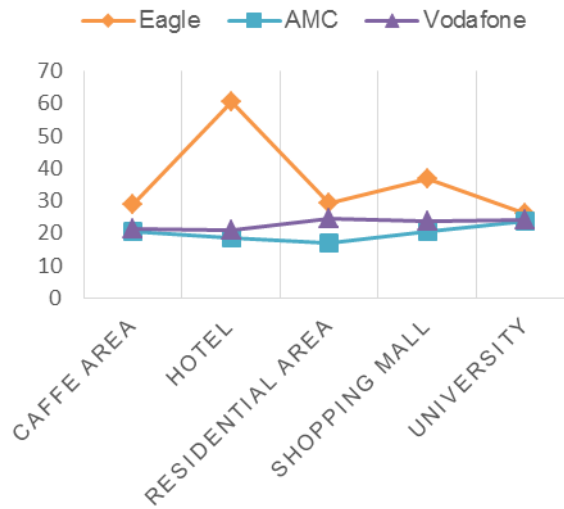

Figure 3. Information related to dl avg. throughput (Mbit/s)

Also it is seen that the highest average throughput related to DL belongs to Eagle Mobile operator. In all the 5 divisions this operator has an upper DL throughput than the other operators.

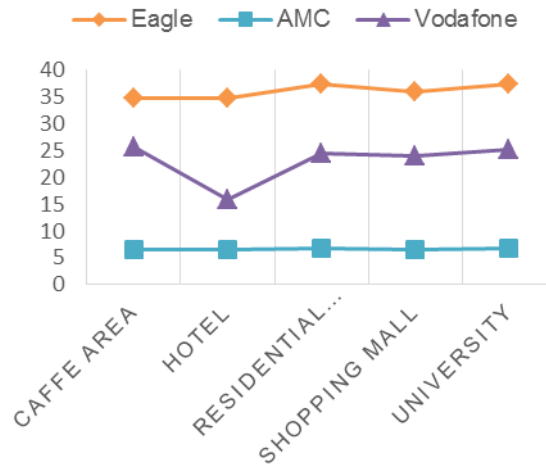

Figure 4. UL max throughput (Mbit/s)

In the UL throughput we have noticed a smaller fluctuation. The values are closer to each other. Even in this case Eagle Mobile operator has the highest values where the max value reached in the residential area with 37.46 Mbit/s.

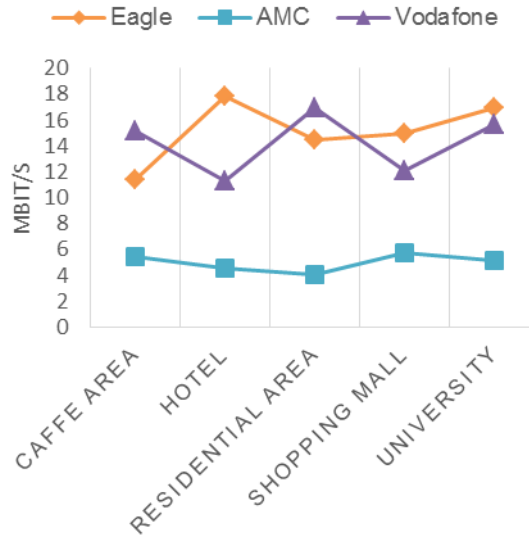

Figure 5. UL avg. throughput (Mbit/s)

In the average throughput of UL there are 2 operators which alter with one another for the highest values (EM and Vodafone). The areas with the highest values are Hotel and Residential areas.

### 3. ANALYSIS

The above table shows information related to mean, median, standard deviation, max and min of measured values. Median values are chosen because since the measures are made in different locations and with irregular schedule the median value describes better the average trends of distributions of both DL Avg. Throughput (Mbit/s) and UL Avg. Throughput (Mbit/s). Standard deviation shows how spread are the values measured. Maximum and minimum data shows the upper and the below value that are measured. From the measured we have noticed that the max values for DL Avg. Throughput (Mbit/s) are measured in Hotel area and belongs to Eagle Mobile operator (60.36 Mbit/s). The min values for DL Avg. Throughput (Mbit/s) are seen in Residential areas

(17.1 Mbit/s). The max values for UL Avg. Throughput (17.81 Mbit/s) are measured in Hotel area and the min values for UL Avg. Throughput (4.09 Mbit/s) are seen in Residential area.

The area with the maximum standard deviation is the hotel area and the area with the least standard deviation is the University area.

Even though we have measured some cases of good UL or DL throughput the averages of all areas are not excellent all the cases, related to the values of 4G LTE that the operators claim to have in the best scenario (100 Mbit/s in downlink and 50 Mbit/s in uplink).

Table 6. Analysis table

AREA		MEAN	MED.	ST.DEV	MAX	MIN
Caffe	DL	23.56	21.31	3.62	28.67	20.71
Hotel	DL	33.21	20.80	19.22	60.36	18.48
Residential	DL	23.70	24.65	5.04	29.34	17.10
Shop.Mall	DL	27.09	23.79	7.08	36.93	20.55
University	DL	24.67	24.29	0.97	26.00	23.72
Caffe	UL	10.63	11.35	4.00	15.14	5.41
Hotel	UL	11.22	11.27	5.40	17.81	4.58
Residential	UL	11.83	14.44	5.57	16.96	4.09
Shop.Mall	UL	10.93	12.13	3.89	14.98	5.69
University	UL	12.58	15.66	5.32	16.99	5.10

### 4. CONCLUSION

Through this paper we have displayed the results of different measures made in Tirana city for 3 mobile operators who offers 4G LTE data service. From the measures we have analyzed the data and have deducted the standard deviation for the areas under control and also the max and min uplink and downlink throughput for all the locations.

So for a summary we can say that the values that we have measured have reached the max values in DL and UL. But this values are measured only in one area, from one operator. Meanwhile the values in the other areas are far away from the rates of 4G LTE (100 Mbit/s in downlink and 50 Mbit/s in uplink). But we deduct that for a better analysis and for deeper information an analysis in a longer period of time and with more samples should be made.

## REFERENCES

- [1] <http://www.4gltemall.com/blog/huawei-e3272-new-lte-category-4-usb-stick/>
- [2] <http://www.ascom.com/nt/en/index-nt/tems-products-3/tems-investigation-5.htm#overview>
- [3] <http://www.instat.gov.al/al/themes/popullsia.aspx>
- [4] [http://www.akep.al/images/stories/AKEP/statistika/2015/Numri\\_i\\_pajtimtar%C3%ABve\\_me\\_akses\\_broadband\\_celular\\_dhe\\_norma\\_e\\_penetrimit.pdf](http://www.akep.al/images/stories/AKEP/statistika/2015/Numri_i_pajtimtar%C3%ABve_me_akses_broadband_celular_dhe_norma_e_penetrimit.pdf)

## BIOGRAPHY

Julian Imami has a Scientific Master Degree in Telecommunication Engineering from the University of Trieste, Faculty of Telecommunication Engineering (2009) and also a MBA from Faculty of Economy, University of Tirana. He is currently following the PHD program near UPT in Telecommunication. He is working as SAP Basis Senior Specialist on Albtelecom sh.a and he has also been involved as a part-time lecturer in the UPT University. Tirana, Albania.

# Design of a Sustainability Program for High School Students at the University of Guadalajara

*Daniel A. Herrera Bojorquez<sup>1</sup>,*

---

## **Abstract**

*Following the world's tendencies towards sustainability, the education in Mexico is aiming to integrate these concepts. Working with children and young people is the most important task of this campaign and the goal is to change the point of view of future generations. High school students are in an age in which they discover the world and forge some of the values and manners that will rule the rest of their lives. It is of vital importance to integrate the students in activities and projects related to sustainability to strengthen their sense of responsibility towards the environment and humanity. The challenge of designing a program integrating the sustainability concepts and make the interesting and appealing to the young students involve creativity and the ability to seize the opportunities as well as overcome the obstacles that may show up in the process. The goal was to integrate art, science and information and communication technologies (CIT's) to design a fun program for the students and to fulfill the guidelines established by the National High School System (SNB). All of the projects were carefully chosen to satisfy each of the thematic axes determined by the SNB. The result is a program that include outdoor activities such as crop production in the green areas as well as community brigades to restore public spaces near the high school, a film projection program that includes different documentaries related to environmental and human issues with a discussion involving the students, the collaborations with a recycling company to gather paper and paperboard, campaigns over waste management and the creation of a collection of books and movies related to sustainability. The design and operation of this kind of programs depends deeply on the collaboration between the academia and the administration of the school to show good results.*

**Keywords:** Education, Sustainability, High school, Program

---

## **1. INTRODUCTION**

Recently there has been an increase in the amount of attention given to the environmental problems, the social crisis and the economic and financial depression, it's all over the news, the media and the social networks. All of that attention has made its way into education and political debate worldwide. Due to that is the responsibility of the authorities in the matter of education to come up with new curricula strongly aimed to develop the student's awareness to these topics. In order to do so, the National High School System (SNB) has integrated Sustainability as a key element of quality education, giving the guidelines to all the high schools to develop projects oriented to involve both the students and the staff in activities and actions to achieve this goal.

The biggest challenge lays in the design of this sustainability program since each high school has different facilities, managers, students and needs, and every factor involved impacts the resulting program. Also the program must be conceived to be fun and appealing for the students, this is a fundamental thing and most of the times it's ignored resulting in failure.

The age of the students is also an important fact to be considered due to the narrow relation with the social media and the new technologies. It's difficult but not impossible to attract the attention of young people towards the world's issues and to develop a critical way of thinking. It is also important to keep in mind that in the end this is the main goal of this program; to provide an integral education to young people in order to shape responsible adults with a deep understanding and sensibility towards the struggles of today's world.

## **2. MATERIALS AND METHODS**

To design the program three documents were consulted, since they established the normativity and the guidelines to the program. These are:

- Manual to evaluate Campuses that request the entry or promotion in the National High School System (Version 3.0).
- Development Plan 2014-2030, University of Guadalajara, Middle Education System (SEMS).
- Sustainability Program for the high schools of the Middle Education System of the University of Guadalajara.

One of the key aspects of the program is the fact that every project requires to generate evidences for its evaluation. Those evidences could be; reports, lists with the information of the participants (students or staff) of each project, agreements of cooperation with other institutions, pictures, among others. There is a file of the sustainability program that gathers all of the records and evidences.

---

<sup>1</sup>Daniel Armando Herrera Bojórquez.: University of Guadalajara, High School No.5, 34220, Guadalajara, Jalisco, Mexico.  
[daniel.h.bojorquez@gmail.com](mailto:daniel.h.bojorquez@gmail.com)

The program must take into consideration 5 specific topics. Those are:

1. Environmental education.
2. Electricity and water saving.
3. Waste management.
4. Conservation and promotion of green areas.
5. Networking with NGO's, companies, civil associations and government agencies.

The resulting program must be presented to a sustainability committee integrated by the administration of the school, representatives of the academia and students for evaluation and approval.

### 3.RESULTS AND DISCUSSION

The sustainability program of the High school No. 5 of the University of Guadalajara for the year 2016 integrates a set of projects, initiatives and proposals conceived to fulfill the requirements of the normativity.

The first point of the program was the creation of a Facebook page to deliver news, information and content related to sustainability and the work carried out in the school. Simultaneously we developed a logo to create an identity to the program. The logo is a modification of the official logo of the school and it's used in the Facebook page as well as in propaganda for the promotion of the projects



Figure 4. Facebook page



Figure 5. Program logo

Another important project is the creation of an urban garden inside the school to train the students on crop production and other topics related to ecology and the importance of plants and insects. This garden provides an adequate space to talk about the environment and to perform outdoors activities. The students are involved in the production of crops such as; tomatoes, peppers, onions, cucumbers, radishes, lettuce, broccoli, spinach, coriander and chard. They also learn about the medicinal properties of plants and how to take care and reproduce them in order to have a constant production for the home use. It's important to mention that all the food that is produced belongs to the students that are involved in the project to encourage them to continue with the activity each semester.



Figure 6. Installation of the urban garden with the students

This year renovations are taking place in the schools bathrooms in order to install water efficient facilities and LED luminaires in the classrooms and buildings to reduce the consumption of both water and electricity in the campus. There is also collaboration between the High school and a company to recycle paper and paperboard. This initiative seeks to reduce the amount of paper waste generate both in the classrooms and offices.



Figure 7. Installation of the urban garden with the students





Figure 8. Production of onions

In regard to the environmental education I thought that combining art and education was a must in order to work with the students and make the topics appealing and fun to propitiate the discussion and analysis of the problematic. The result of this was the creation of a film projection cycle in witch students get the chance once a month to watch a movie or documentary related to a specific topic like; animal rights, health issues, sustainable production of food, poverty, among others. This project works in two phases. The first one consists of the projection itself; the second one involves the creation of a round table to discuss with the students the content of the movie and their point of view regarding the topic or subject. The diffusion of the projection takes place via Facebook witch allows to ad the trailer of the movie and a short synopsis to caught the attention of the students.



Figure 9. Example of a poster used to promote the film projection project

There is also a proposal to certificate the high school as a Styrofoam free school next year. This initiative seeks to promote a more responsible consumption culture as well as reduce the amount of waste generated in the school cafeteria.

#### 4.CONCLUSIONS

This program is in test phase and there is no doubt that in the future it will improve with the experiences acquired during the execution of the different projects and initiatives. The work with the students looks very promising and the results of the projects will attract new students to collaborate in the current and new activities.

It is very important to boost this kind of programs and to carefully select the staff that works with the students to assure an environment of trust and safety to allow the students to feel comfortable and interested in the projects, otherwise the staff could be a reason for the program to fail. Students relate better to young staff members and are very receptive if they see that the person in charge does all of the things that the students are encouraged to do.

The support of the management of the High school is a vital piece of the puzzle. Most of the time when setting up a project there is some kind of inversion, it could be money or time and if the authorities are involved in the program the process becomes really easy. It is important to state that the time that people invest in the projects comes from good will and good results are the best reward and incentive to continue the work.

#### REFERENCES

- [1] Anonymous. (2014) Development plan 2014-2030 University of Guadalajara. Middle Education System.
- [2] Anonymus. (2013) Manual to evaluate Campuses that request the entry or promotion in the National High School System (Version 3.0). National High School System. Mexico.
- [3] Anonymus. (2016) Sustainability Program for the high schools of the Middle Education System of the University of Guadalajara.

#### BIOGRAPHY

Head of the Sustainability Program at the High school No. 5 of the University of Guadalajara. (2016)  
 Student of the Bachelor in Agronomist Engineer.  
 Professional nature photographer.  
 Volunteer in wildlife conservation projects and in The Growing Connection Project of FAO (2004)  
 Member of the editorial committee of the magazine “Sembrando ConCiencia” (2015-2016)

# The Effect Of Service Quality In Tourism Businesses On Customer Satisfaction

*Murat Kocyigit<sup>1</sup>, Ercan Aktan<sup>2</sup>*

---

## Abstract

*In the rapidly changing and diversifying competitive environment of these days, the brand-names which carry on business in tourism sector are obliged to renew and develop their service quality in order to answer the continuous expectations of their customers. Among the most important associational marketing elements in terms of establishing long term relationships between the tourism businesses and the customers of brand-names and sustain those relationships, service quality and customer satisfaction are the leading ones. Tourism businesses need to satisfy their customer both emotionally and attitudinally in order to establish long term relationships with their customers. The traditional performance indicators of the tourism businesses which display their market shares and profit levels were substituted for the quality of the manufactured product or services and customer satisfaction. In this direction, the study aims to research the effect of service quality on the customer satisfaction. Within this context, a model was constructed through Structural Equation Model (SEM) in order to determine the effect of service quality on the customer satisfaction. The relationships between the variants in the model were tested through the data of the questionnaire applied to the customers of the tourism businesses and the theoretically presented hypothesis was also tested. Furthermore, the frequency analysis, explanatory and confirmatory factor analyses and the applications of Structural Equation Model were employed in the analysis of the research.*

**Keywords:** *Customer Satisfaction, Marketing, Service Quality, Tourism Businesses, Trust*

---

## 1. INTRODUCTION

The increase of competition today forces the consumers who have to make a selection among numerous products to be more selective. For that reason, businesses aim to be preferred by consumers through increasing the service quality and diversifying their products. The most important strategical marketing method in providing competitive advantage is to increase the perception of service quality through diversifying the services. Moreover, the increase in the importance of cost given by both consumers and the business caused the increase in the quality. Through the changing marketing perception, the business aim to make the current consumers loyal to their brands through holding them.

The businesses that once intended to expand their market share by gaining new customers have now started to focus on protecting their current market share on account of increased competition and rapid technological developments in today's marketing conditions.

Reference [1] stated that businesses able to provide customers' satisfaction with increasing the quality of the service and so that there is a link between businesses and consumers. Customers who satisfied with the quality of service, trust in businesses. Customers who are satisfied with the service, bring new customers through positive word of mouth communication to businesses.

Using data from the study conducted on the customer of tourism businesses, this study examined the relationship between service quality and customer satisfaction, and a model was proposed suggesting hypotheses based on the associations between the concepts.

## 2. LITERATURE REVIEW

### 2.1. Service Quality

Service is an activity which the brands established in order to satisfy the expectations of the costumers and has an abstract characteristic ([2], [3]). The factors such as abstractness and variability which are general characteristics of service affect the perceptions of the costumers for quality and their satisfaction. The service quality is the evaluation of the superiority of the brands over their rivals and their excellence. The service quality is related to the customer satisfaction and trust for the business. The service quality may be defined as meeting the expectations of the costumers ([4]). Buying the service isn't required for the service quality. The comments of the costumers who bought the service previously, their requests and complaints also may determine level of the service quality ([5]).

---

<sup>1</sup>Corresponding author: Necmettin Erbakan University, Faculty of Tourism, Karatay/Konya, Turkey. [mkocyigit@konya.edu.tr](mailto:mkocyigit@konya.edu.tr)

<sup>2</sup>Aksaray University, Vocational School of Social Sciences, Aksaray, [ercan\\_aktan@hotmail.com](mailto:ercan_aktan@hotmail.com)

Although the more service quality of a tourism business increases the more attitudes of the customers such as the tendency for changing the business, the sensitivity for prices and complaining all tend to decrease; their customer satisfaction and their trust for the business also increase ([4], [6]).

Reference [7], developed a model of conceptual service quality through bringing a wide perspective to the service quality and conducting detailed and comprehensive researches related to the service quality. According to those researchers, the service quality is a result of the expectations of the customers related to the services given by the business and the directions of the perceptions for the performance of the service given by the business during the service. Accordingly, the customer satisfaction and trust are positively affected so long as the businesses execute the performance which the customers expect ([2], [8]).

## 2.2.Trust

The way of servicing to customers is a promise of quality given by businesses. The consumer has the belief that the businesses always and satisfies him equally or it will satisfy in the future and thus establishes the trust for the businesses. Business trust is a sense of security that consumers believe in. They trust the businesses in that it will fulfill their expectations of consumption ([9]).

Consumer's trust in a business is of great importance. The level of the relationship between a brand and its consumers has an impact on the trust placed in that brand. Since trust creates a very valuable exchange relationship between a business and consumers and maintains this relationship, it is considered one of the major determinants of customer satisfaction ([10], [11]). The trust occurring in the mind of the consumer means behavioral dimensions from the points of emotional, cognitive and desire for the business ([10]) Also, consumer trust in a brand arises from the experiences with that brand. Therefore, trust is a matter of experience.

## 2.3.Customer Satisfaction

Customer satisfaction is the general satisfaction level coming from the competence of meeting the expectation and needs of the customer related to the product or service, the inner peace caused by the executed choice of product or service and the feeling of comfort among the consumers. The customer satisfaction is the most effective element of the business in its communication with its target group ([12], [13]).

In order to identify their customers and increase the quality of products and services according to their requests, businesses place emphasis on the expectations and requests of their customers. It isn't possible that the businesses increase their profit rate and market shares without increasing the satisfaction of the customer ([14]).

In some of the conducted researches, service quality and business trust are the major elements with the most important effects in the establishment of customer satisfaction ([1], [15],[16]). Businesses which indulge in their customers or, in other words, satisfy their customers and give them reassurance may sustain their existence ([17]). Accordingly, the trust of the customers for business increases and thus their satisfaction for that business continues as long as they are pleased with the business ([1]).

## 2.4.The Theoretical Model

In the light of the literature data, a theoretical model was developed with the intention of determining the role of service quality in the formation of customer satisfaction using the variable of business trust. In addition, the possible effects of service quality on customer satisfaction were investigated based on the latent variables of business trust. In this regard, the theoretical model and the hypotheses of the study are as follow:

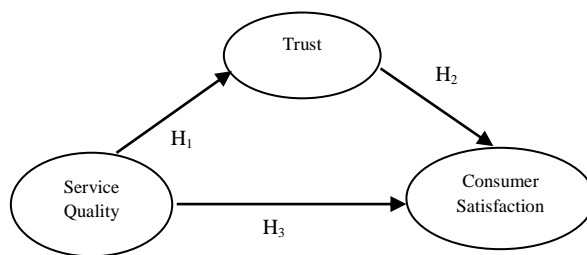

Figure 10. The Theoretical Model

H1 Service quality in the tourism business has direct, positive and significant effect on the business trust. H2 The business trust has direct, positive and significant effect on the customer satisfaction. H3 Service quality in the tourism business has direct, positive and significant effect on the customer satisfaction. The analyzes within the scope of research, was carried out in accordance with this hypothesis test.

## 3.MATERIALS AND METHODS

In order to obtain the accurate data in the research, the questionnaire technique which is one of the most common data collecting methods. First of all, a pretest, pilot study was conducted through the first questionnaire with 18 attitude questions on 47 participants. As a result of the conducted pilot study, it was determined that the observed variants were collected within the

latent variants. Accordingly, the research was continued with a questionnaire of 22 questions including the demographic questions.

The questionnaire form employed in the research consists of three scales. In the first scale, the questions of “service quality” in the SERVQUAL scale formed by Reference [7] in their previous studies. The second scale consists of “trust the business” scale adapted from the studies of Reference [18], Reference [16] and Reference [19]. The third scale includes the “customer satisfaction” scale compiled and developed from the studies by Reference [5] and Reference [1]. In the final section of the questionnaire, there are questions employed in order to determine the demographic characteristics of the participants.

All the items in the scales which were developed to assess in terms of customer satisfaction the effects of service quality-related perceptions and opinions of the customers of tourism businesses on the trust were measured on the basis of 5-point-Likert Type scale. The Likert scale items ranged as follows: (1) represented Strongly Disagree, (2) Disagree, (3) Undecided, (4) Agree and (5) Strongly Agree. SPSS 20.0 and AMOS 19.0 statistical software programs were used for the analysis of data. These two programs were used in coordination as they complemented each other’s features.

## 4.RESULTS AND DISCUSSION

In the analysis, the distribution of the participants according to their socio-demographic characteristics was evaluated through frequency analysis. The demographic characteristics of the participants are given in Table 1. Table 1 presents the demographics of the participants based on their gender, age, educational level and marital status.

Table 2.Socio-Demographic Variables (n=237)

Demographic variables	Value	Frequency	Percent	Demographic variables	Value	Frequency	Percent
Gender	Female	125	52,7	marital status	married	101	42,6
	Male	112	47,3		single	136	57,4
	<b>Total</b>	<b>237</b>	<b>100,0</b>		<b>Total</b>	<b>237</b>	<b>100,0</b>
Age	18-23	35	14,8	Educational Level	Primary(Elem.sch.)	4	1,7
	24-29	33	13,9		Secondary(High sch.)	36	15,2
	30-35	114	48,1		Junior university degree	43	18,1
	36-41	48	20,3		Bachelor’s degree	107	45,1
	42 +	7	3,0		post-graduate	47	19,8
	<b>Total</b>	<b>237</b>	<b>100,0</b>		<b>Total</b>	<b>237</b>	<b>100,0</b>

As seen in Table 1, 52,7% of the participants are male and 47,3% are female. 42,6% of the participants are married while 57,4% of them are single. The majority of the participants (68,4%) are at the ages between 24 and 41. The data concerning the educational level indicates that slightly more than half of the respondents are graduates and postgraduates (64,9%).

Table 2.Explanatory Factor Analysis Results

Variable's name		1	2	3
SERVICE QUALITY	ServiceQuality (Q11)	,777		
	ServiceQuality (Q16)	,768		
	ServiceQuality (Q13)	,707		
	ServiceQuality (Q15)	,693		
	ServiceQuality (Q17)	,675		
	ServiceQuality (Q9)	,640		
	ServiceQuality (Q12)	,620		
TRUST	Trust (Q2)		,731	
	Trust (Q5)		,705	
	Trust (Q7)		,705	
	Trust (Q3)		,685	
	Trust (Q1)		,677	
	Trust (Q6)		,646	
	Trust (Q8)		,547	
CS	ConsumerSatisfaction (Q10)			,830
	ConsumerSatisfaction (Q14)			,668
	ConsumerSatisfaction (Q18)			,584
Coefficient alpha per component		,889	,883	,759
Coefficient alpha		,933		
% of variance explained		62,742%		
KMO		,947		
Barlett		2160,328 (df. 136; p<0,001)		

As a result of the factor analysis executed within the context of the research, it was found that factor weights had similar values in more than one factors. In case a question gets similar values in the different factor columns, it is necessary to exclude the question ([19]).

In this direction, the fourth question in the research had approximate values with more than one factors. For that reason, the fourth question was excluded since it was irrelevant and the factor analysis was repeated. As a result of the conducted factor analysis, the analysis was continued since no other question with approximate factor weight was observed.

Three factors obtained as a result of explanatory factor analysis in the table explain the 62,742% of the total variance.

In the table above, the results of Cronbach's alpha analysis executed within the sampling of 237 people employed in the research were given. As seen in the table, the internal consistency levels of all the scales were above the limits of the internal consistency levels suggested by Reference [19] (0,50).

The discriminant validity of the scales employed in the research was tested through explanatory factor analysis. Three different scales employed in the research was tested through explanatory factor analyses for discriminant validity (KMO=0,947; p<0,001) and 3 different factors which the scale expressions were consistently displayed were obtained.

Table 3. Confirmatory Factor Analysis Results

	$\chi^2$	p	$\chi^2/df$	CFI	NFI	IFI	GFI	AGFI	RMSEA	SRMR
Model Fit Index	161,101	0,004	1,38	0,97	0,92	0,97	0,92	0,90	0,041	0,036

Goodness of fit index assesses how well a theoretical model explains the data collected. Goodness of fit index is tested with Confirmatory Factor Analysis. As Table 3 shows, model structure is acceptable according to the values of goodness of fit index obtained in the confirmatory factor analysis. The application of goodness of fit index determines whether the model being tested is accepted or otherwise. In order for a model to have a perfect fit, RMSEA value needs to be 0.05 or lower ([20], [21]). In the present study, the RMSEA was 0.041 and the  $\chi^2/df$  ratio was 1.38 with  $p < 0.004$ . Also, the other values of goodness of fit index attained the levels acceptable for the model. The satisfying results of the model fit test indicate that the estimated structural coefficients will be evaluated while testing the hypotheses ([22], [23]).

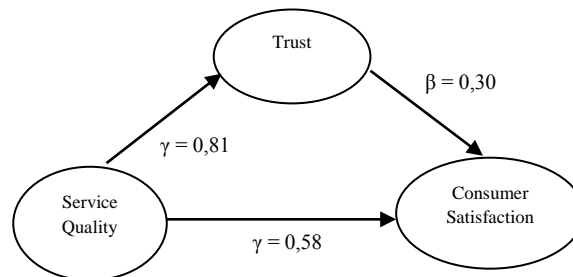

Figure 2. Structural Equation Model

Table 4. Structural Model Results

Dependent variables		Independent variables	Direct Effects (SRW)	S.E.	C.R.	P
TRUST	<---	SERVICEQUALITY	,810	,076	9,587***	
CONSUMER_SATISFACTION	<---	TRUST	,305	,150	2,671***	
CONSUMER_SATISFACTION	<---	SERVICEQUALITY	,575	,146	4,676***	

The results of the analysis performed for the structural model showed that service quality had a direct, positive and significant effect on business trust ( $\gamma=0,810$ ;  $p < 0,001$ ). Thus, H1 was supported. In accordance with data, the hypothesis (H2) that business trust has a direct, positive and significant effect on customer satisfaction was confirmed, too ( $\beta=0,305$ ;  $p < 0,001$ ). Moreover, H3 was confirmed as service quality of business had a statistically significant effect on customer satisfaction ( $\gamma=0,575$ ;  $p < 0,001$ ). In the light of these findings, it was revealed that the direct and significant effect of service quality on customer satisfaction resulted from the intervening variable of business trust. In conclusion, the theoretical model was accepted and of all the hypotheses tested.

## 5. CONCLUSION

The businesses which aim to keep their market shares and their contemporary customers in the increasing current competition conditions are required to establish long term relationships with their customers. Among the most important concepts to be established between the customers and the businesses, the leading ones are the service quality and customer satisfaction. Within this context, it is crucial to determine the relationship between those two concepts. The value of the businesses for their customers depends on their quality. Moreover, providing the customer satisfaction and primarily having the service quality of the business at the satisfying levels for the customers are also required. The more service quality of the businesses increases the more reliance towards the business and customer satisfaction increases.

Accordingly, it was concluded that the service quality had positive and significant effects on the trust for the businesses and customer satisfaction as a result of this study which aims to contribute to the literature and the sector through determining the relationships between the service quality and customer satisfaction and the interaction between them.

The service quality and customer satisfaction are the process of associational marketing communication which comprises long-term communication between customer and businesses. The findings obtained as a result of this research support the necessity for doing the necessities of customer satisfaction in order to create long-term effects beyond creating instant effects

between them and their customers. Within this context, it is necessary to have high level trust towards the business and service quality in order to achieve satisfaction among the customers.

According to the findings obtained as a result of the research, it is required that the tourism businesses and their managers should provide a quality service to their customers if they desire to increase the satisfaction among their customers related to their services. Nevertheless, it may also be stated that increasing the reliance of the customers towards the business and the customer satisfaction and establishing long-term relations with customers may provide significant contributions to the business.

## REFERENCES

- [1] Fornell, C. (1992). "A National Customer Satisfaction Barometer: The Swedish Experience". *Journal of Marketing*, 56(1), 6-21.
- [2] Parasuraman, A., Zeithaml, V. and Berry, L. (1994). "Reassessment of Expectations as a Comparison Standard in Measuring Service Quality: Implications for Further Research", *Journal of Marketing*, Vol:58(Issue:1), 111-124.
- [3] Harris, L. C. and Goode, M. H. (2004). "The Four Levels of Loyalty and The Pivotal Role of Trust: A Study of Online Service Dynamics", *Journal of Retailing*, Vol:80, 139-158.
- [4] Zeithaml, V., Berry, L. and Parasuraman, A. (1996). "The Behavioral Consequences of Service Quality", *Journal of Marketing*, Vol:60(Issue:2), 31-46.
- [5] Cronin, J. J. Jr., Brady, M. K. and Hult, G. T. M. (2000). "Assessing the Effects of Quality, Value, and Customer Satisfaction on Consumer Behavioral Intentions in Service Environments". *Journal of Retailing*, 76(2), 193-218.
- [6] Sirdeshmukh, D., Singh, J. and Sabol, B. (2002). "Consumer Trust, Value, and Loyalty in Relational Exchanges", *Journal of Marketing*, 66, 15-37.
- [7] Parasuraman, A., Zeithaml, V. A. and Berry, L. L. (1988). "SERVQUAL: A Multiple-Item Scale for Measuring Consumer Perceptions of Service Quality", *Journal of Retailing*, 64(1), 12-40.
- [8] Parasuraman, A., and Grewal, D. (2000). "The Impact of Technology on the Quality-Value-Loyalty Chain: A Research Agenda", *Journal of the Academy of Marketing Science*, 28(1), 168-174.
- [9] Lau, G. and Lee, S. (1999). "Consumers' Trust in a Brand and Link to Brand Loyalty", *Journal of Market Focused Management*, 4, 341-70.
- [10] Morgan, R. M. and Hunt, S. D. (1994). "The Commitment-Trust Theory of Relationship Marketing", *Journal of Marketing*, 58 (3), 20-38.
- [11] Chaudhuri, A. and Holbrook, M. B. (2001), "The Chain of Effects from Brand Trust and Brand Affect to Brand Performance: The Role of Brand Loyalty", *Journal of Marketing*, 65(2), 81-93.
- [12] Szymanski, D. M. and Henard, D. H. (2001). "Customer Satisfaction: A Meta-Analysis of the Empirical Evidence", *Journal of the Academy of Marketing Science*, 29(1), 16-35.
- [13] Hellier, P. K., Geursen, G. M., Carr, R. A. and Rickard, J. A. (2003). "Customer Repurchase Intention: A General Structural Equation Model", *European Journal of Marketing*, 37 (11/12), 1762-800.
- [14] Singh, J. and Sirdeshmukh, D. (2000). "Agency and Trust Mechanisms in Consumer Satisfaction and Loyalty Judgments", *Journal of the Academy of Marketing Science*, 28(1), 150-168.
- [15] Hung, C. H. (2008). "The Effect of Brand Image on Public Relations Perceptions and Customer Loyalty", *International Journal of Management*, 25(2), 237-246.
- [16] Darsono, L. I. and Junaedi, C. M. (2006). "An Examination of Perceived Quality, Satisfaction, and Loyalty Relationship: Applicability of Comparative and Noncomparative Evaluation". *Gadjah Mada International Journal of Business*, 8(3), 323-342.
- [17] Oliver, R. L. (1999). "Whence Consumer Loyalty", *Journal of Marketing*, 63, 33-44.
- [18] Ballester, E. and Aleman, L. (2005). "Does Brand Trust Matter to Brand Equity?" *Journal of Product and Brand Management*, 14(3), 187-196.
- [19] Durmuş, B., Yurtkoru, E. S. and Çinko, M. (2013). "Sosyal Bilimlerde SPSS'le Veri Analizi". İstanbul: Beta Yayınevi.
- [20] Jöreskog, K. G., and Sörbom, D. (1993). *LISREL 8: Structural Equation Modeling with The SIMPLIS Command Language*. Scientific Software International.
- [21] Arbuckle, J. L. (2013). *IBM SPSS Amos 22 User's Guide*. Crawfordville, FL: Amos Development Corporation.
- [22] Ayyıldız, H. and Cengiz, A. G. E. (2006). "Pazarlama Modellerinin Testinde Kullanılabilecek Yapısal Eşitlik Modeli (YEM) Üzerine Kavramsal Bir İnceleme". *Süleyman Demirel Üniversitesi İktisadi ve İdari Bilimler Fakültesi Dergisi*, 11(2), 63-84.
- [23] Şimşek, Ö. F. (2007). *Yapısal Eşitlik Modellemesine Giriş: Temel İlkeler ve Lisrel Uygulamaları*. Ankara: Ekinoks Yayınları.

## BIOGRAPHY

Murat Kocyyigit was born in 1985 in Nigde. He graduated from Selcuk University Faculty of Communication in 2004. He had worked as an Media and Public Relations Specialist in private sector for 4 years. Then he started to work as a Foreign Relations Specialist in Aksaray University. He completed her Master's and PhD degree in the area of Public Relations and Advertising at Selcuk University. Now he is working as an Assistant Professor Necmettin Erbakan University Faculty of Tourism. His area of expertise Advertising, Public Relations, Social Media and Brand Loyalty.



## University Students Protecting And Conservating Sea Turtles In The Shores Of Mexico

*Blanca Alicia Bojorquez Martinez<sup>1</sup>, Rocio Araceli Corona Sanchez<sup>2</sup>, Marco Antonio Gomez Ramirez<sup>3</sup>, Daniel Armando Herrera Bojorquez<sup>4</sup>*

### Abstract

*Our country is in a privileged geographical location and is regarded internationally as the country of sea turtles, because six of the seven species that inhabit the planet are specific to Mexican coasts to fulfill their reproductive cycle; now all are considered endangered or threatened. The activity play sea turtles inside the food chain in the world's oceans is of utmost importance, so it's necessary to consider the consequences that lead to the disappearance of these reptiles and their populations due to poaching and smuggling of their products and by-products, causing disturbance to this balance of marine ecosystems of our environment. The overall objective of the project is to protect the populations and nesting sea turtles that come to breed on the shores of six states in Mexico, as well as their immediate environment, through actions to ensure their protection and conservation, monitoring and implementing environmental education in nearby communities through trained, sensitized and committed to the environment college students. Methodology used: patrols, collection, strewn with nests, nesting females measuring, cleaning nests and hatchling release. The analysis of data obtained it's made by quantifying of nesting females, mortality and survival percentage, hatching rate, protected nests index and recording environmental parameters. For fourteen years of work they had been trained 2,724 students in different areas of knowledge. Results: 25.654 nests have been collected; sown 2'456,839 and released 2'049,363 hatchlings. The percentage of survival to adulthood is 1 turtle in 1,000 that's why it is actually important to carry out actions that protect various species of these organisms that inhabit our seas.*

**Keywords:** *Students, conservation, learning, sustainability*

### 1.INTRODUCTION

Our country once had one the largest sea turtle populations in the world, even in the sixties, one could find millions of these chelonians at the Mexican coasts, sadly, during the last 30 years, they have been subjected to an intense exploitation carried out by humans.

Starting from the year 2002, the University of Guadalajara joined to the efforts being made by the ecological foundation Selva Negra in order to mitigate the human depredation done in Mexico to booth turtles and their eggs. We started out at Platanitos camp, Nayarit. The summer of that same year we added Chalcatepec Beach, Jalisco, since then, our presence as the Sea Turtle Protection and Preservation Program Selva Negra/UdeG began to take relevance. We participated also in Baja California Sur, Chiapas and Oaxaca. 14 years later our presence is quite significant, because besides coordinating the protection and preservation program, we maintain close contact with the neighboring communities through various activities involving mainly the primary school children and their families. This represented a very enriching learning in the areas of species preservation and therefore, sustainability.

The species protected are four out of seven existing in the world: olive ridley (*Lepidochelys olivacea*), pacific black (*Chelonia agassizii*), leatherback (*Dermochelys coriacea*) and hawksbill (*Eretmochelys imbricata*) Figure 1. The months during which the protection stage takes place start in May, when the hawksbill turtle begins nesting through March of the following year, when the last eggs collected during December and January hatch.



Figure 1. Sea turtles arriving to Mexico

## 2. MATERIALS AND METHODS

The many different species of turtles manifest similar behaviors, particularly those regarding reproduction. For this reason, the methodologies for the study and management of sea turtles on the nesting beach are very much the same in all species.

The methodology shown below was used in all the beaches throughout the states of Jalisco, Nayarit, Baja California Sur, Oaxaca and Chiapas.

**Patrolling:** Night rounds are made along the beaches of lay with the purpose of protecting any nesting females, figure 2.

**Collection:** During the rounds, the nests of any females found laying are collected while trying to identify the nesting phase in which they are. On the other hand, one can also find the trails that the females leave on the sand. Such trails of entrance and exit are interrupted by a flat, round portion of sand on the upper side of their path, this part is called a “bed”. In order to locate the nest, a rigid stick is used, which is inserted in the sand of the “bed” poking around carefully until no resistance is found. **Seeding of nests:** Once collected, the nests are immediately transported to the seeding area whether it is a pen or an incubation shed, depending of the camp site, figure 3. **Incubation Shed:** The technique used for this type of incubation requires boxes of styrofoam in which the eggs are placed in a pyramid shape on a bed of moist sand 4cm thick, then the eggs are covered completely with moist sand and are placed in the incubation shed for a 50 day period, give or take, depending on the moisture and temperature levels, which are to be constantly monitored. Nearing the end of the incubation period the boxes are checked to extract any hatchlings that may have already emerged. **Incubation Pen:** The pen is to be placed in an area that is commonly used by turtles in natural nesting; near the vegetation on the dryer sand and preferably within the proximity of the camp in order to facilitate surveillance. The pen is to be fenced with mail fence of about a meter and a half height, which is to be, dug into the sand a minimum of 50cm. This is done to prevent the nests being damaged by predators. To make the nests, hole making shovels of the kind that are used to plant trees are employed. The hole must be of 45cm depth for golfina and 65cm for leatherback and it must be vase-shaped. Then the eggs are carefully placed inside while being counted, the nest is covered with sand and marked with a stake that will include the seeding data. During the incubation period a mail cylinder or protection basket of 30cm diameter and 60cm height is to be placed around the nest, buried at about 15cm deep. This is done to prevent the newborns from dispersing as they hatch.

**Measurement of nesting females:** When a turtle is found, her fins are checked for damage done by either predators or human activity.



Student during a night patrol.



Figure 3. Students seeding a nest in a pen.

Figure 2.

**Newborn release:** The hatching of the eggs take on average 45 days for , 4olive ridley8 for hawksbil, 50 for pacific black and 60days for leatherbacks when the incubation takes place in a pen. There are variations of 5 to 10 days depending on climatological conditions and if an incubation shed is used, there will be a delay of 5 days in most cases, except for leatherbacks which usually take up to 10. The release is done by night or before dawn to avoid predators.

**Nest cleansing:** 24 hours after the emergence of the newborns the nests are cleansed to help the hatchlings that may have been left behind and count the non hatched eggs, the underdeveloped eggs, the dead hatchlings and clear the shells of those that did hatch. All the waste is buried in specific areas to prevent the pollution of the decaying matter.

**Data analysis:** This is carried out as suggested by Miller, J (2000) in all the following areas:

**Quantification of Nesting Females:** All females found along the night rounds are counted in order to keep a record and so obtain the weekly, monthly and final percentages.

**Birth-Death rates:** In order to obtain the birth percentage the newborns emerged are counted and registered, later, the nest is cleaned and the hatched living turtles that didn't emerge are included. Then the following analysis is done:

$$\% \text{ Birth} = \frac{\text{No. Hatched eggs}}{\text{No. Seeded eggs}} \times 100$$

Likewise, the dead hatchlings and non-hatched eggs, in their various states of development are counted after the cleansing and the following analysis is done:

$$\% \text{ Mortality} = \frac{\text{Dead hatchlings} + \text{Non-hatched eggs}}{\text{No. Seeded eggs}} \times 100$$

No. Seeded eggs

Indicators: With the finality of establishing success indicators in the protection activities, the following evaluation is done:

Hatching index:  $\text{Newborns both emerged and found in the nest} (I_c = C_e + C_p / H_s^*)$

Release index  $(IL = N_p / N_t \times 100)$

Protected nests index:  $(I_n = N_p / N_t \times 100)$

The total of nests deposited in the beach are taken into account.

Where:  $I_e$  = Percentual emergence index,  $C_e$  = Emerged hatchlings,  $H_s$  = Seeded eggs,  $I_c$  = Percentual hatching index,  $C_p$  = living hatchlings found when the nest was uncovered,  $IL$  = Percentual index of success in protection activities on transplanted nests,  $C_m$  = Hatchlings which die after they emerge or are uncovered,  $I_n$  = Percentual index of success in the total nesting protection activities,  $N_p$  = transplanted nests,  $N_t$  = Total nests.

Surveillance: It is carried out by social service students and camp coordinators as well as field technicians who patrol the beaches where turtles lay eggs and keep human traffickers away.

Record of environmental parameters: The record of environmental parameters was carried out during the nesting seasons in some camps in order to determine how do these impact in the reproductive behavior of sea turtles. The record of temperature inside the incubation shed as well as the individual temperature of the nests was also taken every four hours using thermometers, figure 4.



Figure 4. Students placing thermometers in the nests.

Tides: The sea level is monitored using tide tables obtained at the Center of scientific research and higher education of Ensenada Baja California (CICESE) with the finality of determining the tide levels preferred by turtles to lay their eggs.

Moon Phases: A record of the influence that the different moon phases have over the arriving nesting turtles was also kept.

Female quantification: Rounds were made along the beaches by morning to count the number of fresh trails and so be able to calculate the total percentage of females that arrived during the season.

Record of found nests: All nests found were transplanted and transported to the shed or pen and registered in seeding formats to keep appropriate track of their development.

Number of eggs per nest: The total of eggs is counted including viable, inviable and broken ones and registered in the field sheet, so to determine the fertility and size of nests by species and individual females.

Release of newborns: All living hatchlings, emerged or uncovered were released to ensure the survival of the species. All released newborns were counted and registered in logs to obtain monthly and yearly averages.

### 3.RESULTS AND DISCUSSION

Sea turtle conservation camps emerged as a need due to the alarming speed with which the sea turtle species are going extinct, and not for natural causes, but because of human activity. The stage in the life cycle of these organisms in which they are most vulnerable is during the nesting season, when the sacking of the natural nests and natural depredation increases and so the need to protect them in this critical stage and increase significantly the survival chances. At the conservation camps the females, eggs and newborns are protected while at the same time gathering biological and statistical information necessary, since, as Pritchard and Trebbau noted (1984) sea turtles are lone animals that spend 90% of their life at open sea, and for this reason it's been hard to study them resulting in a vast ignorance of most of their life, besides, unlike other species, they rarely socialize with one another. Their natural predators in their adult stage are sharks mainly. The eggs are depredated by a large amount of animals such as skunks, raccoons, dogs, crabs, ants and fly larvae. The newborns are mainly threatened by skunks, raccoons, dogs, crabs, birds and large fish.

Females typically nest more than once per season and most don't nest in consecutive years. The nesting behavior is highly stereotyped, though some differences are observed in parameters such as the nesting habitat preferences, nesting strategies, size at the time of the first nesting, number of eggs laid and some details in the making of the nest. One reproductive behavior element that is highly divergent are the synchronically and massive arrivals which happen along many days and only occur in some colonies of lora turtles (*Lepidochelys kempii*) and olive ridley (*Lepidochelys olivacea*).

On the following chart are the names and dates of the turtle camps in which work has been carried out in the last decade, Table 1:

Table 1. Relation of camps attended sorted by year and location.

YEAR	NAME OF THE CAMP	LOCATION	STATE
2002/2011	"Platanitos"	Municipio de Compostela	Nayarit
2002/2003	"Chalacatepec"	Municipio de Tomatlán	Jalisco
2004	"Majahuas"	Municipio de Tomatlán	Jalisco
2005/2010	"Mayto"	Municipio de Cabo Corrientes	Jalisco
2006/2008 2013/2014	"Chila"	Municipio de Compostela	Nayarit
2009/2012	"A'ayetsieWakie"	Municipio San Blas	Nayarit
2010/2011	"Asupmatoma"	Cabo San Lucas	Baja California Sur
2009/2010	"Palmarito"	Municipio de San PedroMixtepec	Oaxaca
2011/2012	"El Venado"	Municipio VilladeTututepec DeMelchor Ocampo	Oaxaca
2015/2016	"Otates"	Municipio de Compostela	Nayarit

The camps which we administrated are located on the Pacific Ocean, but even though they're on the same geographical region, each beach is different, with different inclination angles and diverse types of sand, so whenever we arrived at a new site, we had to study it to figure out the best way to extract the nests; for example in the beaches of Jalisco and Nayarit a stick of about 50cm is enough to find the nests by poking the "bed" sites, while in Oaxaca, where the sand is way thicker, a broomstick is needed for the search. In the same way, the same species of turtle shows different behavior depending on the beach they have chosen, for instance the pacific black turtle, when in Nayarit are extremely sensitive to light, noises and colors, to the extent that in order to be able to collect the nests one must wear all black and keep very quiet not to scare it, while when in Oaxaca, none of this things seems to bother them or deter them from laying.

During our work period we were able to observe four of the six species that arrive in Mexico, these are:

Olive ridley (*Lepidochelys olivacea*), leatherback (*Dermochelys coriacea*), hawksbill (*Eretmochelys imbricata*) and pacific black (*Chelonia agassizii*); 73% of the turtles that arrived to the beaches protected by our group were measured, giving up the following results:

Common name: Olive ridley Scientific name: *Lepidochelys olivacea*. This species presented an average length of 67.6cm even though some have measured up to 78cm. The coloration of the shell in adults is olive gray or yellowish, while the belly is of a creamy greenish gray with dark spots at the tip of the fins. The average number of eggs per nest is of about 109, although it varies depending on location. The eggs are of a white color and spherical shape with a 3.3 to 4.5cm of diameter, in this species, the eggs are incubated in sand for 45 days; after the incubation period, the newborns emerge to the surface usually by night and head out to the sea. The species is carnivorous for their entire life; in oceanic waters they feed of pelagic organisms (Galateidae family), fish eggs and even colonies of *Pyrosoma* sp. On coastal areas they feed of crustaceans, moluscii and fish.

Common name: Leatherback. Scientific name: *Dermochelys coriacea*. Considered one of the most endangered species, it is one of the largest living reptiles in the world, surpassed only by some species of crocodiles, figure 5. According to our studies, the average length is 1.80m. Adults show a variety of color patterns, the dorsal part is essentially black with white spots

surrounding the quille increasing in numbers laterally while the ventral portion is mainly white, also some pink spots can be observed on the head and neck. They are better adapted to cold waters than the rest of the species, probably due to their protective leather shell and their fat enriched dermis. They have a nesting cycle of two or three years, females nest four or five times per station, depositing from 61 to 126 eggs, usually about half of the nest consist of small yokeless eggs which are not removed from the nest as they allow the viable ones a better chance. The size of the eggs varies from 6 to 6.5cm of diameter. The incubation period goes from 50 to 78 days and is related to moisture and temperature. The newborn's size varies from 51 to 68mm. Leatherbacks feed exclusively of soft organisms, particularly jellyfish, algae and moluscii.



Figure 5. Student side to side to a leatherback.

Common name: Hawksbill. Scientific name: *Eretmochelys imbricata*. Considered next to the leatherback in risk of extinction, hawksbills have a limited habitat, they prefer tropical, tempered waters and they haven't been known to travel long distances. On average the shell length we registered was of 72cm, this due to the fact that we only received juvenile turtles, adult ones measure up to 91cm, yet this species has suffered so much depredation that in more than a decade we found none reaching this size. The shell is beautifully colored with orange, brown and white. Hawksbill feed of algae, some sea plants and fish, but sea urchins and sponges are their favorites. They inhabit most of the rocky coasts; they live in clear waters with abundant food. They nest by night without large arrivals; the most common is for them to nest alone. The reproductive season varies according to the location, for instance in Jalisco and Nayarit it begins in May and end around October. The size of the nests is up to 250 spherical eggs of 3.8cm of diameter with a pinkish coloration and their incubation period is of 52 to 74 days depending on climatological conditions, the lower the temperature, the longer they take to hatch.

Common name: Pacific black. Scientific name: *Chelonia agassizi* or *Chelonia mydas agassizi*. This turtle is primarily found in coastal areas on tropical and subtropical latitudes. The average length registered is 84cm, which determined that they were all young, since the adults tend to measure at 1.40m. The shell color is practically black, curver than the green turtle with greenish gray spots in a radial or irregular form, on occasions in a bright green, brown, yellowish and redish color, particularly in the young ones. The head and the fins are practically black. The prieta turtle feeds mainly of algae and seaweeds although it is known to occasionally eat moluscii, crustaceans and sea sponges, but these are not a vital part of their diet. Their diet is therefore facultative, it can adapt and shift from a vegetarian diet to a carnivore one during their migrations when they eat tunids, moluscii eggs, fishes, etc. (Esparza 2008) The reproductive cycle takes place typically every 2 or 3 years where the female lays between one to seven nests per season on intervals of 9 to 17 days. The number of eggs laid per nest is of about 65, a sensibly lower number than the green turtle, with an incubation period of 50 to 55 days. The nests are usually placed along wide beaches surrounded by rough terrain. They are known to dig several nests before actually laying their eggs. Below is shown on table 2 the results obtained during the preservation and protection activities. This results are however are partial due to the fact that the Social Service students who participated did so during the summer vacation(10 weeks) and winter vacations (3 weeks); with the exception of camp "Playa chila" and "AáyetsieWakie" Nayarit, where we stayed as responsible for the whole season.

Table 2. Results of fourteen years of work.

CAMP	No. OF NESTS	No. OF EGGS COLECTED	No. OF TURTLES RELEASED
“Platanitos”	7,635	764,290	626,717
“Chalacatepec”	1,300	127,700	89,482
“Majahuas”	3,256	273,673	207,991
“Mayto”	1,395	117,250	87,182
“Chila”	6,509	623,474	617,239
“Boca del Cielo”	1,640	143,356	111,817
“A’ayetsieWakie”	142	15,478	14,704
“Asupmatoma”	1,389	143,356	111,817
“Palmarito”	1,690	172,180	122,310
“El Venado”	698	76,082	60,104
“Otates”	2,100	189,000	154,980
<b>TOTAL</b>	<b>27,754</b>	<b>2’645,839</b>	<b>2’204,343</b>

In order to achieve a successful involvement of the Young students, capacitations are held during the months of April and May where experts are invited to impart it, in this courses we have capacitated 2,342 students mainly students from our university center coursing the careers of Biology and Veterinary; and in less measure from other careers and even private universities, figure 6.



Figure 6. Training students in theory and field work.

Amongst the main activities carried out, the following stand out: Night patrolling, by foot or ATV, detection an quantification of trails, turtle measuring, egg collection, incubation, filling of the collection sheets, seeding an monitoring of the nests, monitoring of the tides, release of the newborns, cleaning of the camp’s influence zone, maintenance of the camp, community work and environmental education. The coordinator does the data intake, makes the report presentations. The main community activities are focused on the creation of workshops about environmental education for both students and their families as well as the agricultural producers. The didactic material though is mainly designed for primary school students as noted in table 3 below.

Table 3. Information about the workshops and the number of attendants.

AIMED TO	N° WORKSHOPS	N° PARTICIPANTS
Kindergarten	8	216
Primary	528	19,536
Secondary	38	1,444
Tecnology High School	16	528
FamilyParents	34	603
AgriculturalProducers	4	278
	<b>TOTAL 628</b>	<b>TOTAL 22,605</b>

The topics covered were as follow: Kindergarten and primary school: Sea turtle preservation and protection, endangered species, water care, energy care, solid waste management, deforestation and reforestation. Figure7.



Figure 7. Students of primary school before a release of newborn turtles.

Secondary school and CEBETA (rural high school): How to make compost, prevention in the use of pesticides, protection and preservation of the sea turtle, national program against the use of pesticides, what is and how does organic agriculture works?

Family parents: Endangered species and foodchain, careof the tiger cat, snakes, birds, crocodiles, and sea turtles, the mangle and it 's relation with the ecosystems.

Agricultural producers: National program against the risks of pesticides, what is and how does organic agriculture work?

We decided to include agricultural producers because usually the camps are placed near production grounds, these producers utilize chemical substances that generate toxic waste which later on ends up filtering to the nesting beaches.

#### 4.CONCLUTIONS

- Sea turtles are unique reptiles which are part of a complex ecosystem, their life cycle is intrinsically associated with exploitable resources such as fish moluscii, crustaceans and algae, of which human societies depend.
- On another view, sea turtles travel long distances and constitute important indicators about the health state of our coasts and marine environments, on both a regional and global scale, which means they are models of study benefiting international sea preservation. Their habitats need to be managed adequately through experts on the matter and with the collaboration of young people who, at the same time reinforce their learning process and collaborate with an important cause in favor of sea life.
- As migratory animals with routes ranging from the tropics to sub polar regions, these organisms take part in the transference of life forms between sea and land. They are considered ecosystem engineers because of the direct influence they exert on coral reefs, seaweed banks and sandy bottoms of the ocean, yet another reason for their protection.
- Being human intervention the main reason of their endangerment, it is important to keep monitoring the beaches of nesting and working with the local populations to spread awareness.
- It is very important to continue with the Environmental Education workshops, especially when we consider that 80% of sea pollution originates in the coastal communities where plastic use abounds and the wrongly managed disposal of its waste has devastating effects on the sea life.
- With the participation of our social services interns of our academic institutions, we hope to contribute in the formation and awareness of several levels of education, as well as perpetuating the vigilance of coasts and neighboring towns in order to diminish the illegal trade and consumption of the eggs.

- In general terms, it is intended that through the implementation of these actions, the sea turtle populations may be reestablished and a deep awareness will remain within these communities.
- The sea turtle protection program of Selva Negra/UdeG is without a doubt a very important space for learning in both academic and formative areas, and as such, we can consider it an apt environment to perform extracurricular activities, which leave an indelible mark. From the discipline of the patrolling and tending of the nests to the experience of cooking their own food and keeping their own space, not to mention, constant teamwork.

## ACKNOWLEDGMENT

To the students involved in the Project, because without their collaboration this work would be impossible. ¡Thank you for fighting for a better planet!

## REFERENCES

- [1] DIARIO OFICIAL, 1990. Acuerdo por el que se establece veda para todas las especies y subespecies de tortuga marina en aguas de jurisdicción nacional de los litorales del océano Pacífico, Golfo de México y Mar Caribe. Lunes 31 de Mayo de 1990. 21-24:p.
- [2] Esparza, H. (2008) Plan de Manejo del Campamento Playa Chila
- [3] Técnicas de Investigación y Manejo para la Conservación de las Tortugas Marinas
- [4] K. L. Eckert, K. A. Bjørndal, F. A. Abreu-Grobois, M. Donnelly (Editores)
- [5] UICN/CSE Grupo Especialista en Tortugas Marinas Publicación No. 4, 2000 (Traducción al español) Determinación del Tamaño de la Nidada y el Éxito de Eclosión
- [6] Jeffrey D. Miller PAG 144-155



# Changed Circumstances as Ground for Non-Performance of Contracts (An Overview of Macedonian Contract Law)

*Faton Shabani<sup>1</sup>*

---

## Abstract

The purpose for which parties enter into a contractual relationship is to create relevant rights and obligations, which means that the interest of these parties is that the created obligations must be performed as agreed. As such, this purpose is supported since the Roman law, through the principle of *pacta sunt servanda*. This principle meant that a party in the agreement is responsible for non-performance, while not entering into the reasons, respectively to the nature of the impediments that led to that non-performance. However, the case law quickly proved that the implementation of this principle frequently charging the party with responsibility for which it cannot really be responsible. After the conclusion of the contract but before the contract is performed a party's situation may change due to changed circumstances, a kind of change that makes it impossible or excessively difficult to perform for both of the parties. Which means, the situation and circumstances have changed since the moment of signing the contract, so the parties would not have entered into the contract, or would have made it differently if they had known what was going to happen. This paper examines exclusion of party's liability due to changed circumstances by provisions in the Law on Obligations of the Republic of Macedonia. The review includes the conditions that must be met to consider as changed circumstances, the obligation to give importance to the other party, and excluding the possibility of invoking the changed circumstances.

**Keywords:** *Changed Circumstances, Law On Obligations*

---

## 1. INTRODUCTION

The purpose of the signed contract is to define the rights and obligations of the parties of the given contract. The interest of both parties, at least at the time of concluding the contract is, the contract to be performed as agreed, i.e. in accordance with generally accepted principle *pacta sunt servanda*. The parties are strictly bound to respect their obligations and deemed to have foreseen events which could interfere with the equilibrium of the contract. However, this principle of strict respect of the agreed obligations, whom (it) reached its review in the modern laws. This is so because the fact that today's trade is increasingly characterized by complexity, dynamism, flexibility and uncertainty. Although the cases in which a party that does not performs is exempt from responsibility for non-performance of contractual obligations are not the same in all national legislations, considering the events that could lead to discharge in the legal doctrine and almost all legal systems distinguish between events that absolutely prevents the performance of obligations; and events that not prevent, but significantly hamper or hinder the performance. The first ones are covered with the institute of force majeure, while the latest with the institute of changed circumstances.

As force majeure (*vis maior or casus maiores*) are considered all the circumstances that could not be foreseen, the consequences that could not have been avoided even if they are foreseen: *quibus humana infirmitas resistere non potest* – that led to their inability to perform obligations and then the obligations of the debtor terminated and he was not forced to perform the promised obligation. For the case, legal doctrine and the legislations, force majeure is the main reason for exemption from liability. On the other hand, after the conclusion, but before the performance of the contract, the situation of one of the parties may change due to changed circumstances, particularly where the contract need to be performed within a specified period of time or in the distant future. In accordance with what can be called the foundation of contract law – *pacta sunt servanda* – however, it will not be considered reasonable if it required the party to perform the contract, regardless of what happens [1]. This led to the emergence of the *clause rebus sic stantibus*, to protect the party where the performance of the contract has become excessively onerous or difficult for one of the parties due to unforeseen circumstances after the conclusion of that contract. This situation today is covered by the doctrine of so-called hardship in common law, *imprévision* in French law and *Wegfall der Geschäftsgrundlage* in German law.

## Notion

Unforeseeable changed circumstances are probably one of the major problems parties – especially those who are party to a long or longer term complex contract – may face in international trade. Indeed, with globalization these problems are increased as the involvement of more and more countries in production and procurement entails even greater imponderables [2]. Changed circumstances create a situation in which it is clear that the contract no longer meets the expectations of the parties and due to the general opinion it would be unfair the contract as such remains in force [3]. This situation causes disruption of the

---

<sup>1</sup> Faculty of Law, University of Tetova, Macedonia [faton.shabani@unite.edu.mk](mailto:faton.shabani@unite.edu.mk)

equilibrium of the contract. Specifically, the equilibrium of the contract can be affected in two principal ways. First, the cost of performance to one of the contracting parties can increase. Second, the equilibrium can be affected as a result of a diminution in the value of performance to a contracting party [4]. According to some legal systems, the unforeseen changes in circumstances that make the contract excessively onerous, but not impossible for performance, authorize the party to as for termination or to renegotiate the contractual terms. The paradigm of *pacta sunt servanda* or sanctity of contract simply places the burden of such a change of circumstances upon the party on which it falls. However, since the old Roman days the principle of *impossibile nulla est obligatio*, or there is no obligation to perform impossible things, has been recognized [2].

## The Approach of Macedonian Law

Law on Obligations of the Republic of Macedonia does not contain specific provisions for the definition and regulation of the institute changed circumstances. It speaks for this institute within the chapter in which regulates the termination of the contract, provided certain articles (five of them) under the common title “Termination of the contract or modification due to changed circumstances.” The provisions contained in these articles after giving the definition of changed circumstances, they directly released into the consequences that arise, respectively the rights arising for the party affected by such circumstances, as well as the conditions to be satisfied that the party concerned may rely on them. Although these provisions do not expressly exclude the possibility of changed circumstances being invoked in respect of other kinds of contract, changed circumstances will normally be of relevance to long-term contracts, i.e. those where the performance of at least one party extends over a certain period of time. According to the first sentence of the article 122: “If after the conclusion of the contract occurred such circumstances that hinder the performance of the obligation of one party, or if because of them it cannot be realized the aim of the contract (...)” In international terms, a precise definition may found in the Principles of International Commercial Contracts (PICC): “There is hardship where the occurrence of events fundamentally alerts the equilibrium of the contract either because the cost of a party’s performance has increased or because the value of the performance a party receives has diminished” (article 6.2.2).

## Circumstances Should Arise After The Conclusion of The Contract

The general condition is that circumstances must have occurred “after the conclusion of the contract”, i.e. not have existed at the time of conclusion of the contract [5]. This is the position taken from article 6:111(1) of the Principles of European Contract Law (PECL) “(...) if performance has become more onerous (...)” If that party had known of those events when entering the contract, it would have been able to take them into account at that time. In such a case that party may not subsequently rely on changed circumstances.

## Circumstances Could Not Reasonably Have Been Taken Into Account By Disadvantaged Party or To Have Avoided Or Overcome Them

Even if the change in circumstances occurs after the conclusion of the contract, paragraph (2) of article 122 makes it clear that such circumstances cannot cause changed circumstances if “they could reasonably have been taken into account at the time of the conclusion of the contract, or have avoided or overcome by the disadvantaged party.” This second condition, which the circumstances to cause an exemption will have to fulfill, describes in a very flexible manner the criterion of foreseeability [6]. This does not necessarily mean that the provision can only apply to circumstances that arise after the conclusion of the contract. It may be the case that the circumstance already existed at that time, but that it was not recognizable to the party [7]. The reference here is thus the reasonable person (*bon père de famille*), in accordance with the general concept of the Law. The element of foreseeability in judicial and arbitration practice proved to be the most difficult for the non-performing party to prove. All potential circumstances to the performance of a contract are foreseeable to one degree or another [8].

The circumstances must also be unavoidable. The non-performing party must have been reasonably unable “to have avoided or overcome” the circumstances. To “avoid” means taking all the necessary steps to prevent the occurrence of the impediment. In most cases, it will coincide with the idea of “beyond his control” [9]. To “overcome”, on the other hand, means to take the necessary steps to preclude the consequences of the impediment. It is closely associated with the condition of the external character of the impeding event. The attention here should be focused on the behavior of the non-performing party [9]. This rule reflects the policy that a party who is under an obligation to act must do all in his power to carry out his obligation and may not await events which might later justify his non-performance. This rule also indicates that a party may be required to perform by providing what is in all the circumstances of the transaction a commercially reasonable substitute for the performance which was required under the contract [10]. Generally, it is suggested that the party will only be excused where extraordinary expenses and effort would be required in order to overcome the occurred circumstances [7].

## Circumstances Should Not Occur After The Period of Time For Performance of Contract’s Obligation

Paragraph (3) provides that the circumstances which prevents a party from performing exempts the non-performing party from liability for damages only if these circumstances occurred within the period of time for performance of contract, i.e. “A party may not invoke the changed circumstances which occurred after the deadline fixed for the fulfillment of his obligations.” This rule, even though not with the desirable clarity as to the substance and the legal techniques, has the effect of termination or modification of the obligation to perform as it is often prescribed in international economic contracts and in some instances also in laws as the primary consequences of changed circumstances.

## The Creditor Has No Right To Terminate If The Other Party Offers or Agrees Modification Of Contract's Terms

Pursuant to paragraph (4) "The contract will not be terminated if the other party offers or agrees fairly changing of certain contract's terms." Paragraph (4) effectively provides that the debtor's right to change certain contract's terms takes precedence over the creditor's right to terminate the contract. As long as the debtor has a right of modification of contract's terms the buyer cannot rightfully and effectively terminate the contract.

### Duty of Notification

The party entitled to ask due to changed circumstances, termination of the contract is obligated for its intention to termination of the contract to inform the other party after he knew that such circumstances would occur and if fails to do so he will be liable for damages which the other party has suffered (article 123 of the Law). Through this provision, the Law expressly proves that it not allows the *ipso facto* termination, but the termination by declaration which notifies the other party for the termination of the contract. It should be noted that the damages for which the party is liable are only those arising out of the failure of the other party to have received the notice and not those arising out of the non-performance [11].

## 2.CONCLUSION

From the examination of the changed circumstances in contracts under regulations prescribed by the provisions of the Law on Obligations of the Republic of Macedonia, some conclusions emerge. The provisions regarding the institute of changed circumstances are included in the section titled as "Termination or modification of the contract due to changed circumstances." As it can be seen by the place where they are assigned concerning the Law, but also by the name of the part that contains these provisions, it can be concluded that the changed circumstances are dedicated exclusively to the cases of termination or modification of the contract, and not conceived as an exception from liability that will be generally available for contracts. The second criticism that can be made to this section is that although its name includes the renegotiate of contract's terms due to changed circumstances, inside it does not regulate the authorization which is recognized as the various domestic legislations, as well as international convents and other international documents (such as ICC Hardship Clause 2003). Such a lack of principle do not contribute at all the accepted principle in legal doctrine, legislation and legal practice that the contract should be maintained in force as far as possible *favor contractus*.

## REFERENCES

- [1]. Lindström, Niklas. "Changed Circumstances and Hardship in the International Sale of Goods", *Nordic Journal of Commercial Law* (2006/1).
- [2]. Schwenger, Ingeborg. "Force Majeure and Hardship in International Sales Contracts", 39 *Victoria University of Wellington Law Review*, p. 709, p. 709-710.
- [3]. *Law on Obligations of the Republic of Macedonia*, No. 18/2001. Amended by the Law amending the Law on Obligations, Official Gazette, No. 4/2002, No. 5/2003, No. 84/2008, No. 81/2009, No. 161/2009. Decision of the Constitutional Court of Republic of Macedonia, No. 121/2001, No. 78/2001, No. 67/2002, No. 59/2002.
- [4]. Vogenauer, Stefan, Jan Kleinheisterkamp. *Commentary on the UNIDROIT Principles of International Commercial Contracts (PICC)*, New York: Oxford University Press, 2009, p. 717-718.
- [5]. Schlechtriem, Peter, Ingeborg Schwenzer. *Commentary on the UN Convention on the International Sale of Goods (CISG)*, second edition, New York: Oxford University Press, 2005, p. 812-813.
- [6]. Enderlein, Fritz, Dietrich Maskow. *International Sales Law: United Nations Convention on Contracts for the International Sale of Goods : Convention on the Limitation Period in the International Sale of Goods (Commentary)*, New York: Oceana Publications, 1992, p. 323.
- [7]. Huber, Peter, Alastair Mullis. *The CISG: A New Textbook for Students and Practitioners*, München: Sellier European Law Publishers, 2007, p. 262.
- [8]. Paragraph 5 of article 65 [draft counterpart of CISG article 79] of the Secretariat Commentary of the 1978 Draft of the CISG. Available: <http://cisgw3.law.pace.edu/cisg/text/secomm/secomm-79.html>.
- [9]. Bianca, Cesare M., Michael J. Bonell. *Commentary on the International Sales Law*, Milan: Giuffrè, 1987, p. 581.
- [10]. Paragraph 7 of article 65 [draft counterpart of CISG article 79] of the Secretariat Commentary of the 1978 Draft of the CISG. Available: <http://cisgw3.law.pace.edu/cisg/text/secomm/secomm-79.html>.
- [11]. Paragraph 15 of article 65 [draft counterpart of CISG article 79] of the Secretariat Commentary of the 1978 Draft of the CISG. Available: <http://cisgw3.law.pace.edu/cisg/text/secomm/secomm-79.html>.

# Agricultural Diffuse Pollution and Sustainability in Ergene Basin

Gokcen Bayrak Yilmaz<sup>1</sup>, Damla Atik<sup>2</sup>, Nuket Sivri<sup>3</sup>

---

## Abstract

Limited water sources in the world are consumed rapidly, it has been seen that water sources should be examined with its basin holistically. When Ergene Basin is examined holistically, it seems to have agricultural area approximately 76% of the area and a significant production value (64% sunflower and 50% rice) in grain production in the country. When total consumption of chemical fertilizers and pesticides in agriculture are analyzed according to the years, an increase is observed.

In this study, it is aimed to determine the long term nutrient (total nitrogen- TN and total phosphorus- TP) loads and consumption of pesticides in Ergene Basin by years. For this purpose, nutrient loads from agricultural diffuse sources have been estimated by using chemical fertilizer amounts and conversion factors, animal numbers and emission factors. The loads from chemical and natural (animal) fertilizers are 26960 tons/year TN and 3650 tons/year TP in the year 2015. Also in this study, monitoring stations have been proposed for the determination of nutrients and other pollutants loads considering sub-basins and pollution sources for the water sources, air and soil can be monitored simultaneously.

When the effects of nutrient loads and pesticides at surface waters and soils in Ergene Basin are considered both ecologically and socio-economically, it has been identified that intended use of water sources was changed, agricultural and aquatic production was negatively affected by deteriorated ecological balance at surface water. Also, the diffuse pollution from agricultural sources causes soil contamination. Ecological and economic sustainability of Ergene Basin are considered to be under a certain threat.

**Keywords:** Agricultural diffuse pollution, nutrient load, pesticide, sustainability

---

## 1. INTRODUCTION

Surface waters are polluted by point and diffuse sources resulting from natural and anthropogenic effects. Nutrient loads coming from both sources have become one of the major ecological issues which also affect aquatic ecosystems. Furthermore, they lead to ecologic and economic losses. Nutrient loads vary by different parameters like precipitation and discharge, water temperature, biological activities in the water masses, conditions of other water quality parameters, natural and chemical fertilizer practice rates, life standards of the communities, wastewater collection systems and water treatment technologies, regulations on the control of nutrient emissions, non-phosphated detergent production, limitations on fertilizer usage, etc [1], [2], [3]. The accelerated eutrophication of freshwaters and to a lesser extent some coastal waters is primarily driven by phosphorus (P) inputs. While efforts to identify and limit point source inputs of P to surface waters have seen some success, diffuse sources remain difficult to identify, target, and remediate. As further improvements in wastewater treatment technologies becomes increasingly costly, attention has focused more on diffuse source. Phosphorus inputs to fresh waters can accelerate eutrophication. Although nitrogen (N) and carbon (C) are also essential to the growth of aquatic biota, most of the attention has focused on P because of the difficulty in controlling the exchange of N and C between the atmosphere and water, and fixation of N by some blue-green algae [4].

Diffuse source pollution from agricultural land use is a complex issue to mitigate due to their storm-dependent and diffuse nature for the management of freshwater worldwide, and improvements in the chemical and/or ecological quality of many waterbodies impacted by farming still need to be achieved. This may be because; controls over nutrient transfers from agricultural land are not yet strict enough, or have not been implemented for long enough or sufficiently widely; agricultural nutrient loads and/or their ecological relevance are overestimated relative to other sources; and other site and environmental factors are more important than nutrient status in determining ecological status [5].

Agriculture clearly needs to remain a viable, productive and profitable industry and it is important to establish clear evidence of the eutrophication impacts of farming so that sustainable solutions that do not unreasonably affect farm profitability can be found. Measures to reduce nutrient emissions to water may be costly to implement, and so it is important to take account of factors that affect their potential effectiveness when implemented. As nutrient inputs to agricultural systems may increase in the future to grow more food and biofuels, and as hydrological patterns may become more extreme under climate change, it will also become increasingly important to identify where water quality and the provisioning of agricultural goods and services are incompatible. The success of diffuse source measures also relies heavily on farmer engagement and skill, and needs to be

---

<sup>1</sup> Corresponding author: Trakya University, Faculty of Architecture, Department of Landscape Architecture, 22100, Edirne, Turkey, gokcenbayrakyilmaz@trakya.edu.tr

<sup>2</sup> Trakya University, Faculty of Architecture, Department of Landscape Architecture, 22100, Edirne/ Turkey

<sup>3</sup> Istanbul University, Faculty of Engineering, Department of Environmental Engineering, 34320, Avcılar/ Istanbul, Turkey

tailored to suit specific site requirements, which will vary from farm to farm. Soils, fresh application of fertilizers/manures and farmyards are all potential sources of nutrients that will deliver variable N and P loads depending on the type of farming system, soil type and site hydrology. Transfers of legacy nutrients will dilute the beneficial impacts of controls over current activities, and strategies to reduce legacy nutrient inputs will clearly not bring immediate benefits. Controlling nutrient loads from agriculture therefore depend not only on how much the inputs can be reduced, but how those inputs are managed on the farm and how cultivation and cropping practices can be adapted to reduce the mobilization and transport of legacy soil nutrients through runoff and erosion. Critical source areas and delivery pathways of P transfer on farms are numerous, dynamic and complex, and will clearly differ between landscapes with permeable and impermeable soils, crop factors, including soil P sorption capacity, crop type, P application type, method and rate, and land management, influence plant uptake of P and only their accurate identification will provide a sound basis for the implementation of effective options to mitigate P transport [4], [5].

Fertilization increases efficiency and obtains better quality of product recovery in agricultural activities. Chemical fertilizers mainly contain phosphate, nitrate, ammonium and potassium salts. But agro-chemical-based intensive agriculture has contributed substantially to the emission of the very powerful greenhouse gases  $\text{CH}_4$  and  $\text{N}_2\text{O}$ , and the entry of pollutants (excessive nitrogen and phosphorus, pesticide and heavy metals) into water bodies and soils. These pollutants have adverse effects on environmental quality and public health, for example, eutrophication of lakes and streams, soil salinity, soil contamination by heavy metals, groundwater accumulation of nitrate and the accumulation of pesticide residues in food [6], [7].

Nitrogen in agricultural areas reach the water environment by three ways: Drainage, leaching and flow. Even in ideal conditions, plants use 50% of nitrogenous fertilizers applied to soil, 2-20% lost evaporation, 15-25% react organic compounds in the clay soil and the remaining 2-10% interfere surface and ground water [6]. Especially in spring and in the beginning of summer, mass fertilizer usage generally leads to an increase in the nutrient concentrations [3], [5]. Depending on the nutrient concentrations, sediments become the secondary nutrient pollution sources [8]. Continuous use of acid-forming nitrogen fertilizers causes a decrease in soil pH, liming, if not carried to prevent the declining efficiency of field crops [6]. Excessive N inputs are often one of the main reasons for the high incidence of pests and diseases in vegetable production, and in turn, this commonly leads to farms using even more pesticide, resulting in high-pesticide residues on vegetables and in the environment. The excessive and unbalanced inputs of chemical fertilizers can cause the damage to soil structure and soil quality. Unbalanced nutrient ratios in mixed chemical fertilizers can cause both biological and physicochemical damage to soils, leading to acidification, secondary salinization and reduction of microbial activity. This damage lowers crop yields and may lead to farmers applying even more fertilizers to try to compensate for the reduced soil productivity and thereby intensify NPS pollution and the cycle of environmental degradation [7].

Pesticides are one of the vital components of modern agriculture practices. Adoption of modern agricultural practices of highly intensive nature to feed the ever increasing population of the world resulted in the widespread pollution of synthetic pesticides in the environment. Thus the presence of these compounds is ubiquitous, often contaminating surface and ground waters as they migrate from their point of application. Pesticides can reach surface water through runoff from treated plants and soil. Contamination of water by pesticides is widespread. Heavy treatment of soil with pesticides can cause populations of beneficial soil microorganisms to decline [9]. Microorganisms are important inhabitants of aquatic ecosystems and soils, where they fulfill critical roles in primary productivity, nutrient cycling, and decomposition. Microorganisms are exposed directly to the pesticides because of the direct and indirect input of the pesticides. Though certain pesticides are known to elicit a variety of chronic and acute toxicity effects in microorganisms, some of them still have the ability to accumulate, detoxify, or metabolize pesticides to some extent. It is supposed that detrimental effects of pesticides on microbial species may have subsequent impacts on to higher trophic levels [10], [11].

In basins, where pollutants are carried into the surface waters, nutrient control is possible with a good basin management. The concept of "Sustainable Basin Management" has gained great importance, and it is now necessary to understand socio-economic function of the region as well as its natural, physical, chemical and ecologic processes. Monitoring is critical to addressing the main objectives of diffuse sources management strategies, and present unique challenges to reliably represent site-specific variations in time and space. Monitoring programs are designed to identify nutrient losses and their sources areas, quantify the effects of mitigation measures, and document conservation program effectiveness. However, there is a cumulative uncertainty associated with water quality monitoring. This uncertainty is derived from stream flow measurement, water sample collection frequency, sample preservation and storage, and analysis. Water quality data must further be related to information on catchment characteristics (e.g., soil properties, drainage conditions, contribution from point sources) and on agricultural activities such as crops grown, fertilization regimes, and soil cultivation practices. Access to such data is crucial for the interpretation of water quality data. Thus, the inherent landscape and management characteristics of monitored catchments must be stated, so that they can be related to surrounding agricultural areas where less information on agricultural management and nutrient loads are available. This would improve the applicability of monitoring results for larger agricultural areas [12].

This study aims to determine the nutrient loads and consumption of pesticide coming from agricultural diffuse sources of Ergene Basin by years. For this purpose, nutrient loads were estimated depending on some assumptions. As a result of all obtained data and estimations, it is aimed to determine the effects of nutrient loads and consumption of pesticide on the ecosystem and socio-economic structure. Besides these, monitoring stations have been proposed for the determination of nutrients and other pollutants loads considering sub-basins. These stations are supposed to include water, air and soil monitoring simultaneously.

## 2. MATERIALS AND METHODS

Ergene Basin spreads throughout an area of 10733 km<sup>2</sup> between Northern Marmara Basin, Meriç Basin and Bulgarian border; it is an inland basin surrounded by coasts of the Black Sea in the northeast, and Marmara and North Aegean Sea (Gulf of Saros) in the south as shown in Figure 1. The main river in Ergene Basin is the Ergene River with 282 km length and 28.73 m<sup>3</sup>/s average annual flow-rate. Average rainfall in the basin is 602.18 mm [3].

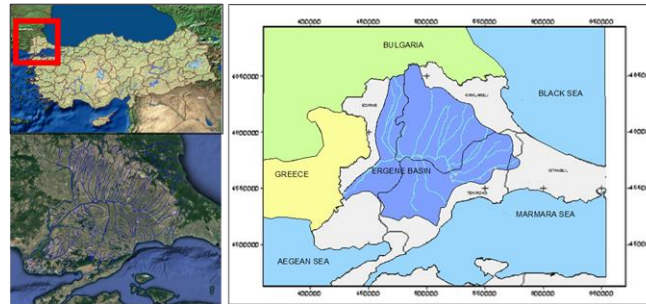

Figure 1. Geographical location of Ergene Basin (26°35' - 42°06')

The Thrace sub-region (Edirne, Kırklareli and Tekirdağ provinces), where Ergene Basin is located, constitutes one of the significant agricultural and livestock production centers. While the total cultivated area of the sub-region is 1.239.102 ha, only 65.1% of this area is used for agricultural purposes. Monoculture agriculture and burning stubble applied for many years remove organic matter in the soil and thus plant-available nitrogen is caused to decrease year by year. This is the region which uses the most fertilizer per unit area, with an average of 145 kg per hectare (2-fold that of Turkey average). Approximately 20% of the fertilizer especially nitrogen fertilizers consumed in Turkey is used in the region [3], [13]. There are 14 surface waters monitoring stations in the basin [14].

Point sources which result in surface water pollution in Ergene Basin are domestic and industrial pollutant sources. Diffuse sources are agriculture areas (chemical and natural fertilizers), meadow and forest areas, urban and rural settlements, vehicle emissions, and irregular solid waste landfills [2], [3], [15]. Between the nutrient loads coming from point and diffuse sources in Ergene Basin, diffuse sources have a considerable share (Table 1), and TP load is considerably low compared to that of TN [2].

Table 1. Distribution of point and diffuse pollutant loads in the basin [2]

TN (24 000 tons/year)		TP (2700 tons/year)	
Loads from Diffuse Sources	Loads from Point Sources	Loads from Diffuse Sources	Loads from Point Sources
86 % (82% from agriculture)	14 %	83 % (92% from agriculture)	17 %

It is seen that diffuse sources' contribution to the nutrient load in the basin is 86% for TN and 83% for TP, which are both considerably high. Considering the load distribution of the diffuse sources in the basin, it is seen that the chemical and natural fertilizers constitute nearly the total load (83% TN, 93% TP). Diffuse sources which lead to the pollution of the surface water sources in Ergene Basin are agricultural areas (chemical and natural fertilizers), meadow lands and forests, urban and rural settlements, industrial areas, vehicle emissions, and leachate of "wild dumping" areas [2], [3].

Table 2 - Land-use in Ergene Basin [3]

Type of land-use	Area (ha)	Area (%)
Agricultural areas	819862	75.7
Forests	168778	15.6
Urban settlements	51669	4.8
Rural Settlements	25630	2.3
Meadows	11459	1.1
Industrial areas	5075	0.5

In order to determine the nutrient loads from agriculture and examine the change by years, the number of animals (cattle, small cattle, poultry) obtained from Turkish Statistical Institute, unit loads, type and amount of chemical fertilizers obtained from the Provincial Directorate of Food Agriculture and Livestock of Edirne, Tekirdağ and Kırklareli, and active nitrogen and active phosphorus conversion factors [16] were used. Since it is not accurately possible to determine the size of the diffuse loads, in an attempt to estimate the nutrient loads caused by the use of fertilizers, some assumptions were made during the practice of selected estimation methods (Table 3). Nutrient (N and P) loads of agricultural diffuse sources were estimated to be the total annual load based on the variety of transport mechanisms within the annual water cycle [17], [18]. Data on use of fertilizers were obtained on the basis of administrative boundaries (Edirne, Tekirdağ and Kırklareli). In the calculation of nutrient loads from agricultural areas, chemical and natural fertilizers and losses were taken into account. Nutrient loads of diffuse sources were deemed to expand homogenously throughout the basin, and not to change from its source to surface water.

Table 3. The assumptions made in the calculation of TN and TP loads [2]

	TN	TP
Cattle Unit loads (kg/animal/year)	10	5
Small cattle Unit loads (kg/animal/year)	5	1
Poultry Unit loads (kg/animal/year)	0.2	0.05
Losses from soil to receiving environment	% 15	% 3

In order to examine the consumption of pesticide in the basin by years, pesticide sale amounts were obtained on the basis of administrative boundaries from the Provincial Directorate of Food Agriculture and Livestock of Edirne, Tekirdağ and Kırklareli.

### 3.RESULTS AND DISCUSSION

In Ergene Basin, we can see that agricultural areas have the highest usage share (rate of 75.7%) (Table 2). It is seen that nutrient loads from diffuse sources in the basin is 86% for TN and 83% for TP and the chemical and natural fertilizers constitute nearly the total load (83% TN, 93% TP). In other studies [19]-[21], it is stated that the agricultural activities have been historically, and the dominant nitrogen sources as well.

We can see the chemical fertilizer consumption in Ergene Basin from 1994 to 2015 in Figure 2.

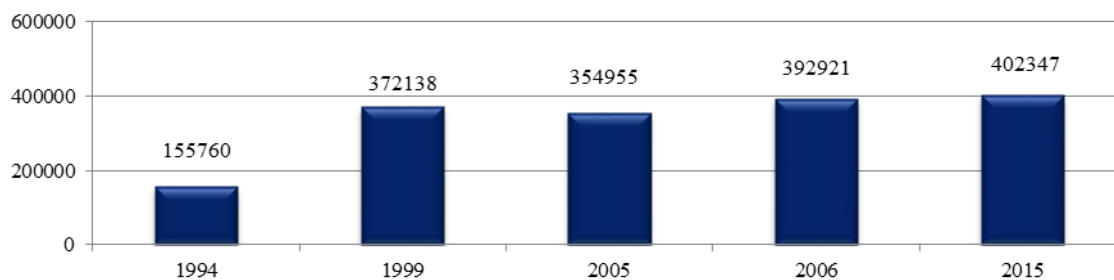

Figure 2. Chemical fertilizer consumption in Ergene Basin by years (tons)

When we examine the amount of chemical fertilizers used in the basin in the 20-year period (Figure 2) we can see an increase. In this case, N and P load is considered to be increased by years as we see in Figure 3.

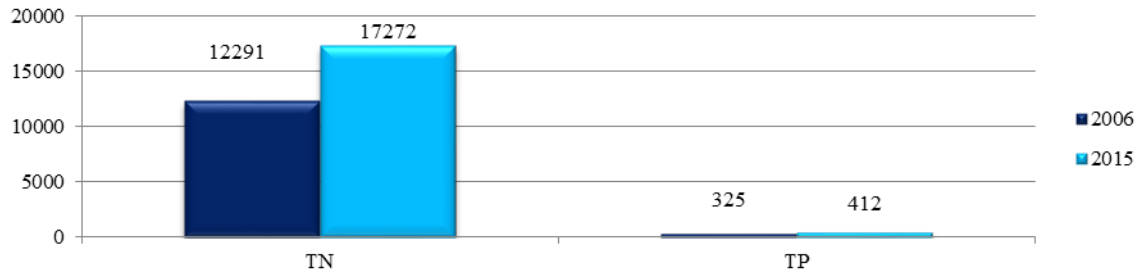

Figure 3. Nutrient loads from chemical fertilizers in Ergene Basin from 2006 to 2015 (tons/year)

When we examine the Figure 3 we can see an increase 41% of TN and 27% of TP. We can see the nutrient loads from natural fertilizers in Ergene Basin from 2001 to 2015 in Figure 4.

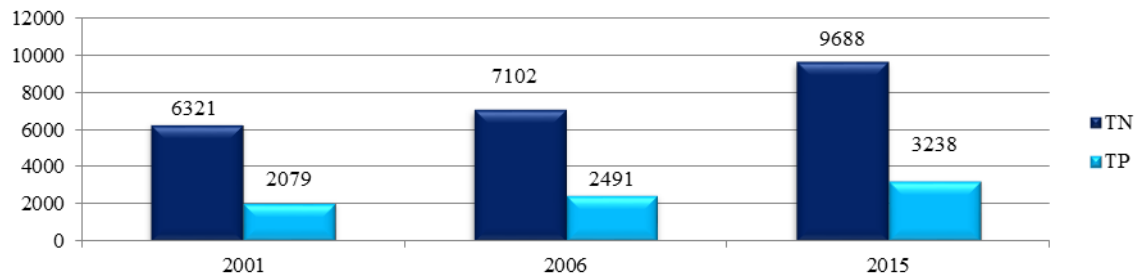

Figure 4. Nutrient loads from natural fertilizers in Ergene Basin by years (tons/year)

When we examine the nutrient loads from natural fertilizers in Ergene Basin by years (Figure 4), by almost 55% increase for both of TN and TP are seen in recent 15 years. We can see the total nutrient loads from diffuse sources in Ergene Basin from 2006 to 2015 in Figure 5.

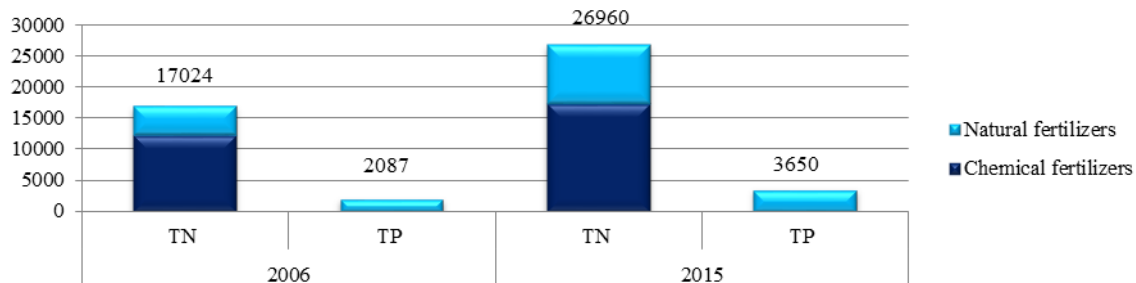

Figure 5. Total nutrient loads from agricultural sources in Ergene Basin from 2006 to 2015

When we examine the total nutrient loads from diffuse sources in Ergene Basin in the 10-year period (Figure 5) we can see an increase 58% of TN and 75% of TP.

Agricultural activities have decreased in the basin where the fertilization is 2-fold that of fertilizer consumption in Turkey [2], [13]. However, agriculture sector is still among the most important factors that shape socio-economic structure of the basin. Furthermore, it is estimated that fertilizer usage will continue at significant rates. When we consider the fact that the global climate change affects the hydrological cycle and nutrient transport, it seems that the fertilizer usage control is vital for agricultural production [2], [22], [23].

In order to decrease nutrient loads from natural and chemical fertilizers in agricultural areas, farmers should be informed; good agriculture practices and organic agriculture should become widespread, incentives for the recycling of organic manure should be improved; fertilizer management system should be used to prevent excessive fertilizing for plants and tighten the regulations and national standards on organic waste disposal and pesticides use [4], [7], [24], [25]. To protect the water and soil we can enhance plant nutrition through balanced measures that include crop rotations with N-fixing crops, judicious use of organic and inorganic fertilizers. Besides lime can be used to regulate high soil acidity; a protective organic cover on the soil surface must be enhanced and maintained by using cover crops and crop residues [26]. Being an important environmental problem in the basin and increasing the transportation of nutrient materials, erosion should be decreased by means of afforestation, meadow development, tillage and crop residue management, buffer strips, riparian zones, terracing, contour tillage, cover crops, impoundments, wetlands and suitable agricultural methods. These practices tend to reduce rainfall impact on the soil surface, reduce runoff volume and velocity, and increase soil resistance to erosion. The response to management change can range from



months to centuries and differ along the soil (5 to 15 years), river (1 to 5 years), and lake (10 to 30 years) watershed continuum [4], [12].

We can see the pesticide consumption in Ergene Basin from 2001 to 2015 in Figure 6.

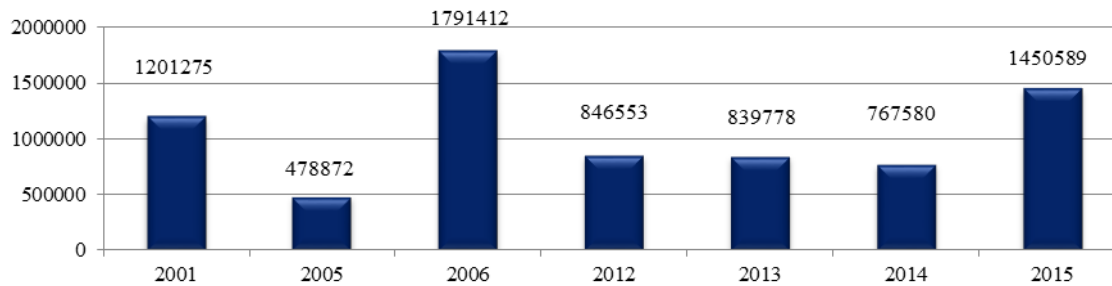

Figure 6. Pesticide consumption in Ergene Basin (kg-lt)

When we examine Figure 6, an increase from 2001 to 2006 and a decrease from 2006 to 2014 are seen. This decrease may be due to the trainings and regional studies of the Ministry of Food, Agriculture and Livestock. But off the record fertilizer and pesticide use in the region is also known. But a significant increase (89%) is observed the last 1-year period. However, because of the incorrect and intended land use the agricultural fields have been decrease and amount of fertilizers and pesticides used per area have been increase. Pesticides are often considered a quick, easy, and inexpensive solution for controlling pests. However, pesticide use causes a significant cost. The economic impact of pesticides in non-target species (including humans) has been estimated at approximately \$8 billion annually in developing countries. Pesticides have contaminated almost every part of our environment. Pesticide residues are found in soil, air, in surface and ground water across the countries. Pesticide contamination poses significant risks to the environment and non-target organisms ranging from beneficial soil microorganisms, to insects, plants, fish, and birds. What required is to weigh all the risks against the benefits to ensure a maximum margin of safety. All activities concerning pesticides should be based on scientific judgement and not on commercial considerations. The best way to reduce pesticide contamination (and the harm it causes) in our environment is for all of us to do our's part to use safer, non-chemical pest control (including weed control) methods [9].

Long-term monitoring is essential; which should include baseline, extreme, and representative sites. Also, it was suggested that a few selected sites should be intensively monitored in conjunction with a larger number of less intensively monitored sites. Adequate long-term (10 years) monitoring of catchments is essential to reliable model calibration; however, there is often a limited amount of long-term water quality data that would be sufficient to estimate nutrient and sediment loads in streams (representative of storm and base flow). A well-distributed network of monitoring stations across all land uses, topographic conditions, and sub-catchments of the larger catchment would assist in model evaluation and verification when estimating at smaller scales. Legislation to ensure the continuity of long-term monitoring, cross-media monitoring at different scales such as field, farm catchment, sub-basin and basin and detailed information on soil and farm management are needed [2], [3], [12].

Despite 14 surface waters monitoring stations exist in the basin [14], there is no long-term, systematic water quality monitoring data. Similar studies [2] and [12] highlight the importance of the need for systematic monitoring in order to determine the trends and achieve reliable results. Not only the water quality data but also the other media (soil, air) should be monitored simultaneously in the basin by environmental information systems. Determination of surface water quality is not capable alone. Therefore; the necessary data for future studies in Ergene Basin must define the land use, all water resources in the basin of the river sub-basin scale, quality, quantity and usage patterns in a systematic way by using geographic information systems. In order to obtain the water quality data systematically, water quality monitoring stations should be established at intervals to show the characteristics of the basin; water and sediment quality and hydrology parameters of the river and its tributaries should be measured regularly. At the same time water quality monitoring stations should be in the same zone with stream gaging station [24], [27]. Water quality data must further be related to the information on both catchment characteristics (e.g., soil properties, drainage conditions, contribution from point sources) and agricultural activities such as crops grown, fertilization regimes, and soil cultivation practices. Access to such data is crucial for the interpretation of water quality data. Thus, the inherent landscape and management characteristics of monitored catchments must be stated, so that they can be related to surrounding agricultural areas where less information on agricultural management and nutrient loads are available. This would improve the applicability of monitoring results for larger agricultural areas [12].

#### 4.CONCLUSION

In this study, it is aimed to determine the nutrient loads from agricultural diffuse sources of Ergene Basin by years; it is found that the data of annual TN and TP loads increased. In order to decrease total annual loads, first of all, land-uses should be proper and suitable for the usage purposes; this is only possible by means of a sustainable basin management. Proper land usage ways should be determined by urban and local planners, and local decision-making mechanisms in accordance with national plans and regulations. In addition, there should be important sanctions for auditing the performance of these plan stipulations. In order to prevent the environmental pollution, development policies should be improved and basin management must be operated based upon those policies. In Turkey, basin management is a new concept and it is not implemented nationwide. Integrity of the Ergene River ecosystem has long been under pressure for the last three decades of the all pollutant sources from the basin and, in fact, the river ecosystem has suffered a collapse in the downstream region. The change in Ergene River does not only affect its own ecosystem, it also ruins three different ecosystems as well. Nutrients, organic substances,

suspended solids and specific pollutants are carried by Ergene River through the Meric River, Lower Meric Delta and Aegean Sea (Gulf of Saros) ecosystems [28]. Lower Meric Delta is one of the important bird areas and any changes in the area based on the nutrients will affect the aquatic life, food chain will be destroyed, and biological diversity will be adversely affected. A decrease in the biological diversity will result in the extinction of predators and the decrease of performance in the natural and cultural production; thus, the use of chemicals in the agricultural production will increase.

Sustainable agriculture outcomes can be positive for food productivity, reduced pesticide use and carbon balances. Also it will minimize specific soil threats such as soil erosion by wind, water, and tillage, and soil compaction and physical deterioration and the loss of biodiversity from the soil. Significant challenges, however, remain to develop national and international policies to support the wider emergence of more sustainable forms of agricultural production [29].

Spatial and temporal distribution of pollutant sources should be determined within sub-basins through periodic monitoring, and water quality model studies should be conducted on Ergene River and its reaches. In this way, the changes by biochemical processes from the source of total loads to the receiving environment will be taken into account, and the detected process schemata will be a useful tool for basin management. It is believed that the non-ecologic basis of the land-use and consideration of administrative boundaries rather than sub-basins in basin management, lead to management failures in determination, management and audit of pollutant sources.

It is assumed that it will be a great step in the basin management to estimate the total ecological costs (agricultural, economic and social) caused directly or indirectly by the nutrients and other pollutant loads in Ergene Basin; and to place these values into national and regional development plans.

## REFERENCES

- [1]. G. Bayrak Yılmaz, A. Öngen, N. Sivri, D.Z. Şeker, Estimation of Nutrient and TSS Loads of Ergene River and Its Potential Risk on Ecosystem, *46th Croatian & 6th International Symposium on Agriculture*, Section 1. Agroecology and Ecological Agriculture, Opatija, February 14-18, 2011, p.4, 2011.
- [2]. G. Bayrak Yılmaz, Determination of the Impact of Long Term Nutrient Loads on Surface Water: A Case Study of Ergene Basin. PhD Thesis, İstanbul University Institute of Science, In Turkish, 2011.
- [3]. G. Bayrak Yılmaz. and N. Sivri, Estimation of Nutrient Loads from Point and Diffuse Sources in Ergene Basin and Its Potential Risk on Ecosystem, *Fresenius Environmental Bulletin*, Volume 23 - No 12a, 3202-3211, 2014.
- [4]. A. Sharpley and X. Wang, Managing agricultural phosphorus for water quality: Lessons from the USA and China, *Journal of Environmental Sciences* 26 (2014) 1770–1782, 2014.
- [5]. P.J.A. Withers, C. Neal, H.P. Jarvie and D.G. Doody, Agriculture and Eutrophication: Where Do We Go from Here?, *Sustainability* 2014, 6, 5853-5875; doi:10.3390/su6095853, 2014.
- [6]. S. Savci, Investigation of Effect of Chemical Fertilizers on Environment, *APCBEE Procedia* 1 (2012) 287 – 292, 2012.
- [7]. B. Sun, L. Zhang, L. Yang, F. Zhang, D. Norse, Z. Zhu, Agricultural Non-Point Source Pollution in China: Causes and Mitigation Measures, *AMBIO* 2012, 41:370–379, 2012.
- [8]. G.F. Birch, B. Cruickshank, and B.Davis, Modelling Nutrient Loads to Sydney Estuary (Australia), *Environ Monit Assess* (2010) 167:333–348, 2010.
- [9]. W. Aktar, D. Sengupta and A. Chowdhury, Impact of pesticides use in agriculture: their benefits and hazards, *Interdisc Toxicol*. 2009; Vol. 2(1): 1–12, doi: 10.2478/v10102-009-0001-7, 2009.
- [10]. C. S. Jacobsen and M. H. Hjelms, Agricultural soils, pesticides and microbial diversity, *Current Opinion in Biotechnology* 2014, 27:15–20, 2014.
- [11]. S. Wasi, S. Tabrez, and M. Ahmad, Toxicological effects of major environmental pollutants: an overview, *Environ Monit Assess* (2013) 185:2585–2593, 2013.
- [12]. A. N. Sharpley, L. Bergström, H. Aronsson, M. Bechmann, C.H. Bolster, K. Bořling, F. Djodjic, H.P. Jarvie, O.F. Schoumans, C. Stamm, K.S. Tonderski, B. Uleń, R. Uusitalo, P.J.A. Withers, Future agriculture with minimized phosphorus losses to waters: Research needs and direction, *AMBIO* 2015, 44(Suppl. 2):S163–S179, 2015.
- [13]. K. Bellitürk, Edirne İli Unzünköprü İlçesi Tarım Topraklarının Beslenme Durumlarının Belirlenmesi, *Tekirdağ Ziraat Fakültesi Dergisi Journal of Tekirdağ Agricultural Faculty*, Bellitürk, 2011 8 (3) s.8-15, In Turkish, 2011.
- [14]. RTMEU, RT Ministry of Environment and Urbanisation, *Ergene Havzası Su Kalitesi İzleme Raporu İlkbahar ve Yaz Dönemi*, In Turkish, 2015.
- [15]. J. Holas and J. Klir, Diffuse Pollution Management in the Czech Republic at the Example of Selected Watersheds Case Study, *Diffuse Pollution Conference Dublin* 2003 3A: Agriculture, Dublin, 3.1-3.6, 2003.
- [16]. M.T. Sağlam, M. Bahtiyar, C. Cangir, H.H. Tok, *Soil Science*, Anadolu Press, Tekirdağ, Turkey, In Turkish, 1993.
- [17]. W. Rast and F. Lee, Nutrient Loading Estimates for Lakes, *Journal of Environmental Engineering*, Vol. 109, No. 2, April, 1983, Paper No. 17851, 1983.
- [18]. P.J. Johnes, Evaluation and Management of the Impact of Land Use Change on the Nitrogen and Phosphorus Load Delivered to Surface Waters: The Export Coefficient Modelling Approach, *Journal of Hydrology* 183 (1996) 323-349, 1996.
- [19]. ICPDR, The Danube River Basin District Part A – Basin-wide Overview, Short: “Danube Basin Analysis (WFD Roof Report 2004)”, *ICPDR Document IC/084*, 18 March 2005, 2005.
- [20]. F. Caille, Integrated Environmental Assessment of Nutrient Emissions in a Mediterranean Catchment: A Case Study in La Toreda, Catalonia, Doctoral Degree, Universitat Autònoma de Barcelona Institut de Ciència i Tecnologia Ambientals, 2009.
- [21]. P. Haygarth, P. Johnes, D. Butterfield, B. Foy, P. Withers, Land Use for Achieving ‘Good Ecological Status’ of Waterbodies in England and Wales: A Theoretical Exploration for Nitrogen and Phosphorus, *DEFRA Final version*, December, 2003.
- [22]. SERAD, Scottish Executive Rural Affairs Department, *Nitrogen and Phosphorus Supplement to the Code of Good Practice on Prevention of Environmental Pollution From Agricultural Activity*, May 2001 1 84268 969 X, © Crown copyright 2001, 2001.
- [23]. A.N. Sharpley, T. Daniel, T. Sims, J. Lemunyon, R. Stevens, R. Parry, *Agricultural Phosphorus and Eutrophication*, 2nd ed. U.S. Department of Agriculture, Agricultural Research Service, ARS-149, 44 pp, 2003.
- [24]. *Council Directive of 12 December 1991 concerning the protection of waters against pollution caused by nitrates from agricultural sources* (91/676/EEC), 1991.
- [25]. *Tarımsal Kaynaklı Nitrat Kirliliğine Karşı Suların Korunması Yönetmeliği*, 23 Temmuz 2016 Cumartesi RG Sayı: 29779, In Turkish, 2016.
- [26]. FAO, *Status of the World's Soil Resources*, p.15, 2015.

- [27]. *Yüzeysel Sular ve Yeraltı Sularının İzlenmesine Dair Yönetmelik*, 11 Şubat 2014 Salı RG Sayı: 28910, In Turkish, 2014.
- [28]. G. Bayrak, The Dynamic of Heavy Metal Concentration of Lake Gala and its Surroundings, Trakya University Institute of Science Department of Soil, MSc Thesis, Edirne, In Turkish, 2004.
- [29]. J. Pretty, Agricultural sustainability: concepts, principles and evidence, *Phil. Trans. R. Soc. B* (2008) 363, 447–465, 2008.

### **BIOGRAPHY**

SHE IS GRADUATED FROM ISTANBUL TECHNICAL UNIVERSITY DEPARTMENT OF ENVIRONMENTAL ENGINEERING IN 1999. SHE ACCOMPLISHED HER MASTER'S THESIS IN TRAKYA UNIVERSITY IN THE DEPARTMENT OF SOIL AND DOCTORAL THESIS IN ISTANBUL UNIVERSITY IN THE DEPARTMENT OF ENVIRONMENTAL ENGINEERING. SHE HAS BEEN ASSISTANT PROFESSOR IN DEPARTMENT OF LANDSCAPE ARCHITECTURE SINCE 2013. SHE IS MARRIED AND HAS TWO SONS.

# Importance of Sustainability and Development in Terms of Maize (*Zea Mays*.L.) Grown with Drip Irrigation

Aybuke Kaya<sup>1</sup>, Dilek Bostan Budak<sup>2</sup>

---

## Abstract

Maize is an important cereal in human nutrition and in animal feed production. It is a very good protein source. Maize, due to the high yields being obtained from many fields of use and unit area, to meet the food needs of a growing population and increasing accordingly, ensure efficiency in production and production will contribute greatly to improve the country's economy. In recent years, drip irrigation method has been disseminated among maize producers. Early adapters very interested and began to use drip irrigation in their fields. In particular, the use of corn drip irrigation method is useful in many ways. Drip irrigation not only decrease water use but also reduces energy costs. Both manufacturers and countries are contributing to the economy.

**Keywords:** Development, drip irrigation, sustainability, maize, efficiency.

---

## 1. INTRODUCTION

Maize, the world and our country is known to be one of the most important grains in hot climates. Both human are used as a primary food source used in both animal nutrition. In recent years, industrial production is seen among the most commonly used cereal (Konuskan et al., 2015). Maize is an important plants used in animal feed production. There are also different uses of maize kernels. It can be used as flour, corn oil, glucose and starch.

In the world corn planting area is about 165 million hectares. Production is about 850 million tons. The average yield is about 520 kg / da (Fao, 2013). According to Tuik 2013, Turkey's average in recent years of the maize acreage is about 600 thousand hectares. Average production is approximately 4.5 million tonnes, the average yield of about 750 kg/da. However, given planting area of maize in Turkey in 2015, it was 688 170 hectares. Maize production is about 6.4 million tons. The yield of 930 kg / da (Tuik, 2015). When we look at the history of the past 20 years of cultivation area, production and yield significant increases were observed. In addition, the increase in irrigation facilities with the Southeastern Anatolia Project, increased use of hybrid seeds and depending on the development of production techniques and increased average corn yield in Turkey, it has a higher situation than the world average yield.

In recent years, the increase in irrigated area showed significant increases in maize production in our country. In addition, the development of irrigation irrigation areas have expanded rapidly consciousness. Thus, water demand has increased too. However, our country is bordered by water resources. Hence it is necessary to use the water resources in an economic manner. Plant growth is directly related to the water. Awareness of evapotranspiration for determining the required water is important. Watering plants is an important factor in terms of efficiency. However, the lack of water resources in our country requires a more efficient use of water (Biber and Kara, 2006).

The efficiency of the application stated that the excess water to increase significantly (Yıldırım and Kodal, 1998). The world and our country is increasing soil salinity sourced from excessive watering. This situation leads to loss of efficiency in production. Some areas remain out of production due to salinity problems. There can be voided earth about salinity problems in 13% of the total agricultural area. It is known that the problem of salinity and alkalinity of approximately 1.5 million hectares of land in Turkey. These areas were 41% (614 617 ha) lightly salted, 33% of (505 603 ha) of salt, 0.5% of the (8641 ha) alkaline, 8% of the (125 863 ha) light salty- alkaline, 17.5% of them (264 958 ha), stated that the saline-alkaline soil (Sonmez, 2004).

Drip irrigation is taken from the source water, by passing through the closed pipe system to the root zone of plants by application to the plant roots with different water application means. This method has been applied without creating a stress resulting from the basic principles plants outdoor humidity. It is given a small amount of irrigation water into the pressure pipe and emitter of from stem. The most prominent feature of all the land not be soaked (Anonymous, 2008).

Anonymous according to 2008, this method has many benefits. These, with the same amount of water used for irrigation of wider areas. It makes water evaporate quickly because plant roots are shaded area. Performed from fertilization are used at the

---

<sup>1</sup>Corresponding author: Mustafa Kemal University, Faculty of Agriculture, Department of Agriculture Economics, 31001, Antakya/Hatay, Turkey. [aybukekaya@mku.edu.tr](mailto:aybukekaya@mku.edu.tr)

<sup>2</sup>Cukurova University, Faculty of Agriculture, Department of Agriculture Economics, Adana, Turkey.

highest level. It is not from watered prevents weed growth between rows of planted. Aboveground plant parts are not wetted plant diseases do not occur. The soil surface is dry soil tillage, spraying operation is reduced and costs are reduced. Aeration of soil better. Irrigation labor is low. Regular watering plant undergoes stress is avoided. Water transport does not occur because there is no loss of nutrients. Salt ratio allows the use of higher irrigation water. Watering, fertilizing and spraying can be done with. Erosion and soil loss is prevented. Facilitate the irrigation of sloping field. Thus, the standard product is obtained and the costs are reduced.

Soil salinity water affects plant growth directly or indirectly. The excess salinity in the soil water causing to an increase in osmotic pressure. In this case the plants from the soil to improve plant growth by limiting water intake adversely affects. It also prevents the nutrient intake (Ekmekci et al., 2005). Drip irrigation allows reducing the negative effects of irrigation water salinity. Thereby increasing the efficient use of water.

Drip irrigation is to protect the air and water balance in the soil. The aloofness of the plant's water stress and lack of water provide increased efficiency. The prevention of soil moisture changes in irrigation and soil water pressure is reduced. Thereby facilitating uptake of water and nutrients, high yield is obtained. Especially maize until my death in physiological plant nutrients, when the plant needs, application of plant root zone, and because it prevents excessive irrigation made of a nitrogen purge it can be expressed as an increase nitrogen use efficiency. Drip irrigation in maize, both a productivity aspect is superior to furrow irrigation water saving aspect (Karasahin and Sade, 2011).

The world is seen as the global climate changes. This situation requires the replacement of an irrigation system in the cultivation of agricultural products. Therefore the land in the drought-resistant and less water consuming plant varieties are preferred. Irrigation systems that make sustainable water resources, practitioners, economists, it is stated that continuous investigated by environmentalists and technical staff. It is environmentally sustainable and scientific research and work condition requirements in terms of effective use of water resources. Pressure-drop-irrigation systems in the income derived from the per hectare was determined to be higher than furrow irrigation. It also provides more efficiency increase compared to drip irrigation and furrow irrigation to save water. The yield obtained from maize grown with drip irrigation, it was found to be higher than other irrigation (Kaltu and Gunes, 2010). It is important innovation development. Innovation is one of the most important elements for the continuation of sustainable agricultural production in Turkey (Ozertan, 2013). Low productivity in agriculture it is necessary to reorganize the available resources to eliminate. In particular, the examination of incentive systems and the development of irrigation systems in these areas is extremely important. Because agriculture is to contribute to economic development. These contribute to agricultural products, production contributing factor is evaluated in the form of contributions and contribution to the currency market (Taban and Kar, 2015) .

Drip irrigation saves resources, training costs, are determined to have a significant effect on yield and farm products. Drip irrigation in areas with water scarcity should be considered. Labor of the increased use of drip irrigation was higher in plants that stated (Suresh Kumar and Palanisami, 2010) .

The agricultural sector contributes to both sustainable and efficient production growth and development. Economic development is linked to technological change (Barrett et. al, 2010).

With increasing population in need of food it is constantly increasing. Production is increasing to meet this need. Effective use of resources used while increasing production is also important. Use of scarce groundwater and surface water resources has been active in the preparation of this issue. In this study, the drip irrigation water requirement is more in corn plants was conducted to determine the effects of irrigation.

## 2.CURRENT SITUATION IN TURKEY

Data about Turkey's maize production is presented in Table 1. Maize is an essential crop and Turkey has an important place in meeting the world's grain needs. High yield has increased steadily since the production obtain

Table 1. Maize production in Turkey

Maize Areas (ha), Production Amount (tonnes) and Yield			
Years	Hectares	Tonnes	Kg/da
1990	515 000	210 000	408
1995	515 000	190 000	369
2000	555 000	230 000	414
2005	600 000	420 000	700
2010	594 000	431 000	726
2011	589 000	420 000	713
2012	622 609	460 000	739
2013	659 998	590 000	894
2014	658 645	595 000	903
2015	688 170	640 000	930
<b>Average</b>	599 742	418 600	679,6

As seen in Table 1, it has seen steady increase in corn acreage in the last 25 years. Especially draws attention increase in corn fields after the 2000s. Depending on the amount of production it is also increasing corn acreage. But the main reason is the increase in the amount of the increase in corn production efficiency.

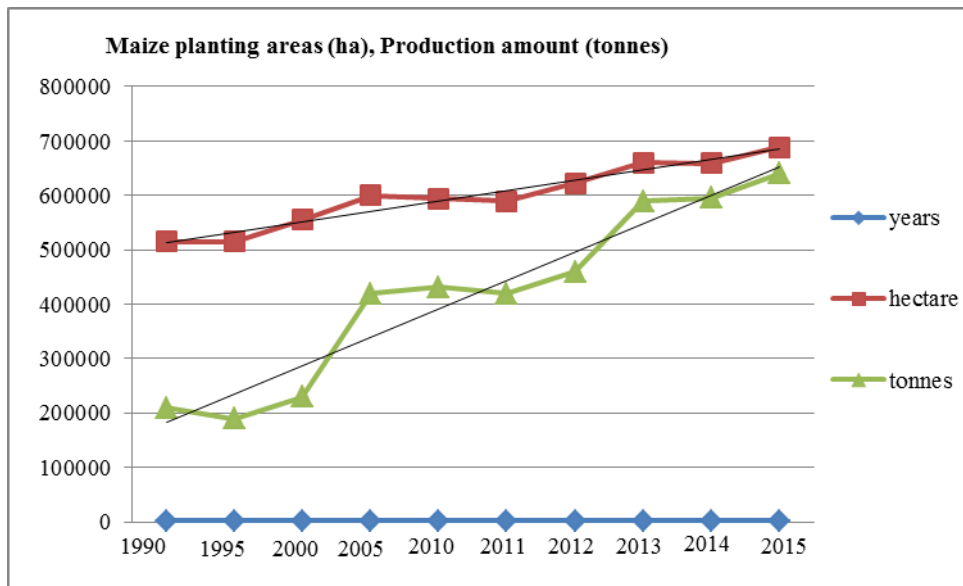

Figure 1. Maize production and yield in Turkey

The planting of area has increased to 690 000 hectares in 2015. Although small fluctuations from year to year in the maize field, it is seen that the rise, generally. The amount of corn production in Turkey has increased in the last 25 years. Amount of production 210 000 tons from 000 tons increased to about 640. Although the trend was found to be increased in small fluctuations from year to year (Figure 1).

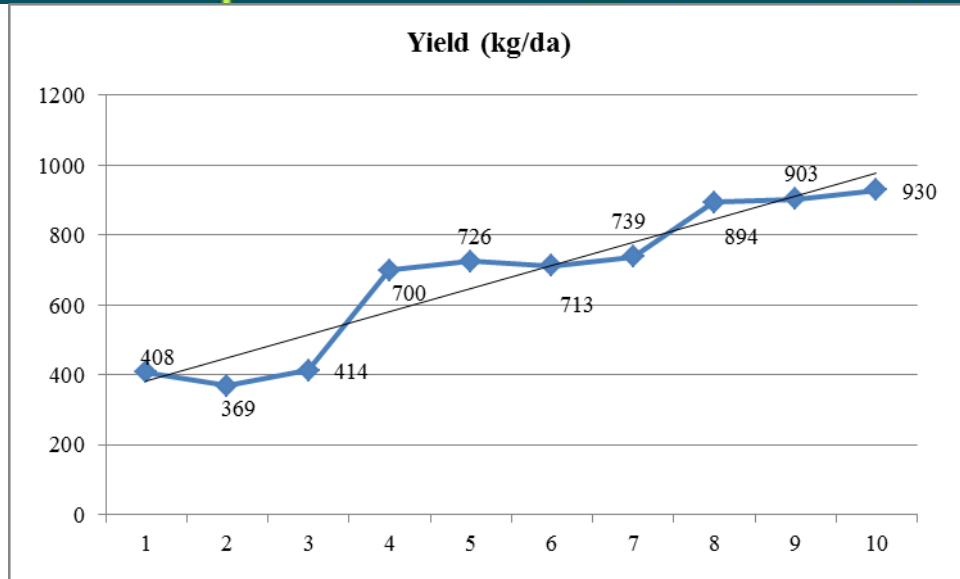

Figure 2. Graphical representation of Turkey's maize yield

The corn yield from year to year fluctuations are seen generally increased over the last 25 years. In 1995 408 kg yield is obtained, in 2015 yield has increased 930 kg. Turkey's seems to be the trend in the increase of maize production (Figure 2). Drip irrigation is expected to increase in yield. With this method, irrigation and fertilizer use is made intensely.

### 3.CONCLUSION

With increasing population also need of food it is constantly increasing. the production is increasing to meet this need. Effective use of resources used is also important while increasing production. The plant of maize watering requirements to use the drip irrigation method is more useful in many ways. In the plants are made intensive use of water and fertilizer. The implementation of drip irrigation method allows for the effective of fertilization. It provides high yields being obtained. Also soluble nutrients for the plants located in areas close to these systems can be sent to the desired point. Thus, the plant to be used in food costs are reduced. Especially in the field of land with deformity and provide uniform distribution of the water in the late and reduce the use of inputs. affected by weather phenomena such as wind during irrigation. Affected by weather phenomena such as wind during irrigation. Desired time allows irrigation. Also weed problems between the rows is a row of corn plants is seen less. Leaf diseases occurring in plants is declining. Drip irrigation, it is one of pressure irrigation system. Drip irrigation not only decrease water use but also reduces energy costs.

### REFERENCES

- [1] Anonymous (2008), Drip Irrigation Systems, Ministry of Agriculture and Rural Affairs, Adana Agricultural Enterprise, Publication No: 17, ISBN-978-975-407-266-2.
  - [2] Anonymous, (2013) <http://www.tuik.gov.tr>
  - [3] Anonymous, (2013) <http://www.fao.org/statistics/en/>
  - [4] Biber, C. and Kara, T. (2006) Evapotranspiration and Irrigation Restricted Application of Maize. *OMU Journal of the Faculty of Agriculture*, 2006,21(1):140-146.
  - [5] Barrett, C. B., Carter, M. R. ve Timmer C.P. (2010) "A Century-long Perspective on Agricultural Development", *American Journal of Agricultural Economics*, 92(2), page 447-468.
  - [6] Ekmekci, E., Apan, M. and Kara, T. (2005) The Effect of Salinity Plant Growth, *J. of Fac. Of Agric., OMU*, 20 (3): 118-125.
  - [7] Kaltu, S. and Gunes, E. (2010) Effect of Different Irrigation Systems on Yield and Income of Maize (*Zea mays L.*), *Research Journal of Agricultural Science*, 3 (2): 27-31, 2010 ISSN: 13083945, E-ISSN: 1308-027X.
- Karasahin, M. and Sade, B. (2011) Different Irrigation Methods in Hybrid Maize (*Zea mays L. indentata S.*) Grain Yield and Yield Components Effects, *Journal of Agricultural Faculty of Uludag University*, 2011, Volume 25, number 2, 47-56.
- Konuskan, O., Atus, I. and Gozubenli, H. (2015) Yield and Yield Components of Some Dent Maize Genotypes Grown as Main- Crop in Amik Plain Conditions, *Journal of Agricultural Faculty of Mustafa Kemal University*, ISSN:1300-9362, 20(2):1-6.
- Özertan, G. (2013) The Role of Structural Transformation and Technology Use in Agriculture Turkey, Bogazici University Department of Economics, Accessed: 06/09/2016
- Sonmez, B., (2004) The management of barren and saline land reclamation research in Turkey. The salinity management in irrigated areas symposium papers book.20-21 May, Ankara, 157-162.
- Suresh Kumar, D. and Palanisami, K. (2010) Impact of Drip Irrigation on Farming System: Evidence from Southern India, *Agricultural Economics Research Review* Vol. 23 July December 2010 pp 265-272.
- Taban, S. and Kar, M. (2015) Development Economics Book, The revised and expanded 2. Printing, 5. chapter Agriculture and Development, page 96.
- Yıldırım, Y. E. and Kodal, S. (1998) Irrigation in Ankara Conditions Impact on Corn Yield, *Tr. J. of Agricultural and Forestry*, 22, 65-70, © TÜBİTAK.

**BIOGRAPHY**

Aybuke Kaya in 2013, Cukurova University, she completed his bachelor's degree in the department of Agriculture Economics. Mustafa Kemal University, she completed his master's degree the department of Field Crops in 2016. She also continues to master's degree studies at Cukurova University. Mustafa Kemal University has been working as a research assistant in the department of Agriculture Economics.



# User Dimension on Socio-Cultural Sustainability of Traditional Settlements: Kaleiçi / Edirne / Turkey

*Damla Atik<sup>1</sup>, Gokcen Bayrak Yılmaz<sup>1</sup>*

---

## Abstract

*The processes of change observed in many field today such as urbanization, urban transformation and globalization -all caused by socio-cultural, technological, economic and politic factors- have great influence on people, relations, environment, houses and cities within the world. As an important component for cultural sustainability and worth of historical heritage, the traditional settlements are also affected by these changes together with their users. The problem occurs when the culture dissolves during transformation. But it can be solved by not ignoring social environment and socio-cultural sustainability while transforming the physical environment. It is aimed to put forth how socio-cultural sustainability is provided in Kaleiçi Traditional Settlement of Edirne/Turkey as a case study. Methodology includes field study; observation, photography, questionnaire as well as statistical evaluation. Finally it is determined that users sustain their traditions and daily life routines beside transformation thus socio-cultural sustainability is provided substantially. Besides physical and spatial re-arrangements during transformation process, the importance of cultural components and socio-cultural factors within user oriented studies are mentioned.*

**Keywords:** *User, Traditional Settlements, Transformation, Socio-Cultural Sustainability, Edirne*

---

## 1.INTRODUCTION

Environment that surrounds people and their activities can be classified as social and physical environment. Thus user is meant by social environment while space is meant by physical. Interaction and attraction between people and environment go on in endless way. This means user needs and expectations take role in forming spaces and vice versa space usage affect people. Space design considering user aspects and needs as well as feedback become important in terms of sustainability. Satisfaction of people is the key of much success, so user becomes the main aim of design and other studies as well. The most particular way is survey and questionnaires especially during change process to make proper designs and get useful feedbacks in terms of sustainability. Transformation may not be prevented but can be processed. Physical changes are observed at first sight but social one must also be taken in consideration with its socio-cultural dimension. Being all the earnings of the past culture contains every routine of people involved in daily life; language, religion, music, poem, rituals, beliefs, social values and norms, behavior and interaction of people, tradition; so we call them socio-cultural components of social environment related to people. Dwellings as the main structure interacted with physical environment are handled in this study by means of traditional Turkish house within its traditional values. Sustainability depends on learning the culture and adopting it to present at this point we mean; so necessity of examining the traditional settlements came in sight related to culture.

## 2.MATERIALS AND METHODS

It is aimed to put forward the user dimension on socio-cultural sustainability of traditional settlements with case study of Kaleiçi/Edirne/Turkey. Thus a literature overview is done about Kaleiçi as well as traditional Turkish House within its social and physical dimensions. Field study including observation, photography and questionnaire is brought about. Maps of the settlement revised. Thus both social and physical transformation of a traditional settlement is determined.

### 2.1.Traditional Turkish House

Traditional Turkish cities are homogenous settlements where various social and ethnical groups live together in a harmonious way. The basic principles of the settlements are the unity with natural environment in terms of direction, climate and topography with the enrichment of the characteristic silhouette [1]. A spatial organization for the private and public area within the yards, gardens, non-end streets and squares were seen to provide alienation.

Districts are the smallest administrative units where the basic elements of cities such as house and street systems; economic, social and cultural facilities gather. Neighborhood mentioned with the same meaning with district is another specific quality of traditional life. Neighborhood is significant in Turkish tradition. It represents mutual support and helping, besides visiting and keeping secrets; sharing social values like religious days, wedding, funeral, birth and circumcise ceremony. These values are all supported with hospitality. Hospitality means welcoming guests, treating them well, make them comfortable as they are in their own house. Therefore a special space decorated better than the other rooms is designed in the house for guests. The neighborhood relations were sustained in guestroom or daily used room, kitchen, yard or garden of the houses; strengthened with lower garden walls and passages with the next door thus the relations are experienced within confidence and unity. Social

---

<sup>1</sup>Trakya University, Department of Landscape Architecture, 22100 Edirne, Turkey. [damlazybekoglu@trakya.edu.tr](mailto:damlazybekoglu@trakya.edu.tr)

and economic cooperation, toleration, sympathy and the unity between neighbors is the genuine of the system called “Neighborhood Unit” by the planners of today.

The streets as being one of the important elements of city form had organic shape in Ottoman cities refereeing defense.

The various alignments of houses within direction changes of streets besides land form and human scale also had a role in shaping city form.

Traditional Turkish House is known and qualified as “planned and formed in harmony with life culture and customs of Turkish family” and “fulfilled the requirements of Turkish individuals for centuries” [2]. The height of the buildings, with their distance to neighbor and bay window sizes are determined by common consent. The buildings are also in harmony with natural topography in order not to prevent the sunshine and landscape of each building [3]. The houses are generally designed as 2 or 3 floors. The first floors are closed to the street for privacy; requirements are fulfilled by usage of gardens and yards. The other floors are planned using bay windows to contact and expand over the street, get more daylight and air besides their esthetical value. The roofs are designed with wide eaves both for protecting the building from air conditions and for esthetical value. The houses composing the traditional pattern become specific with their private and semi-public usage by means of their front gardens. Users as another characteristic feature of traditional houses were mostly extended families consisted of 2 or 3 generations living under the same roof.

## 2.2.Kaleiçi Settlement

Kaleiçi is known as the first settlement of Edirne. It is located inside the curve of Tunca River flowing to Meriç as shown in Figure 1 and founded by Romans on approximately 50 hectares at the end of 2<sup>nd</sup> century surrounded by castle walls. It had a significant role in colonization politics of Roman Empire. Kaleiçi was the only settlement with its Byzantine, Genovese and Jewish population when Edirne had been conquest. According to researchers we can learn that Islamic, Jewish and Greek districts of Edirne had been recorded by the end of 17<sup>th</sup> century after Turkish districts showed up at the beginning of 16<sup>th</sup> century.

Kaleiçi means “inner part of a fortress”. Thus first dwellings and urban structures took place inside the walls; and then outer of them by time as the city developed and grew as shown in Figure 2. We are informed about a rehabilitation done at 1902 after a natural disaster, fire, demolished the settlement unfortunately. The region was mended like the original as possible having grid plan system with stone pavements which is another significant character of the settlement besides its unique population in terms of cultural union.

The settlement is still tetragon shaped; surrounded by old city walls that not exist anymore; the same perpendicular roads crossing each other; consist of two districts (Mithatpaşa and Dilaverbey) separated by Balıkpazarı street as shown in Figure 3; with a few Jewish and mostly Turkish population today.

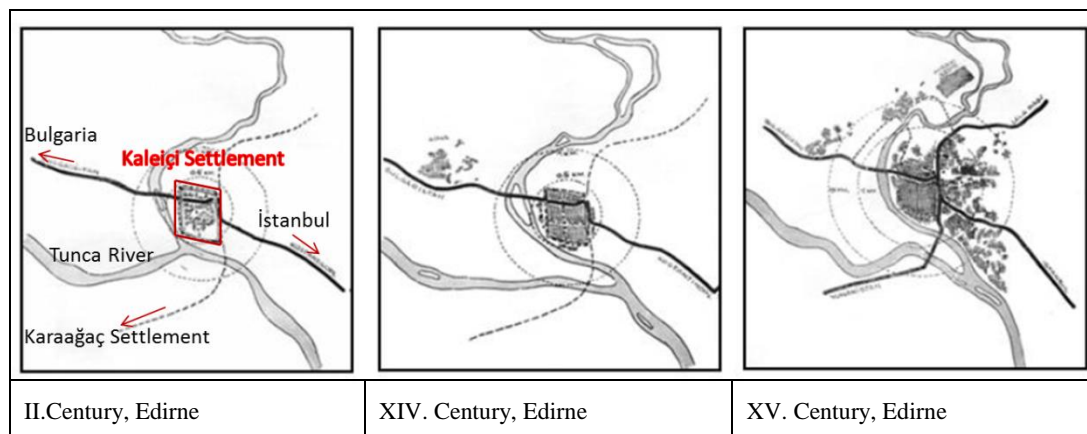

Figure 1. Maps of Kaleiçi in Edirne before XVI. Century (Developed from [4] and [5])

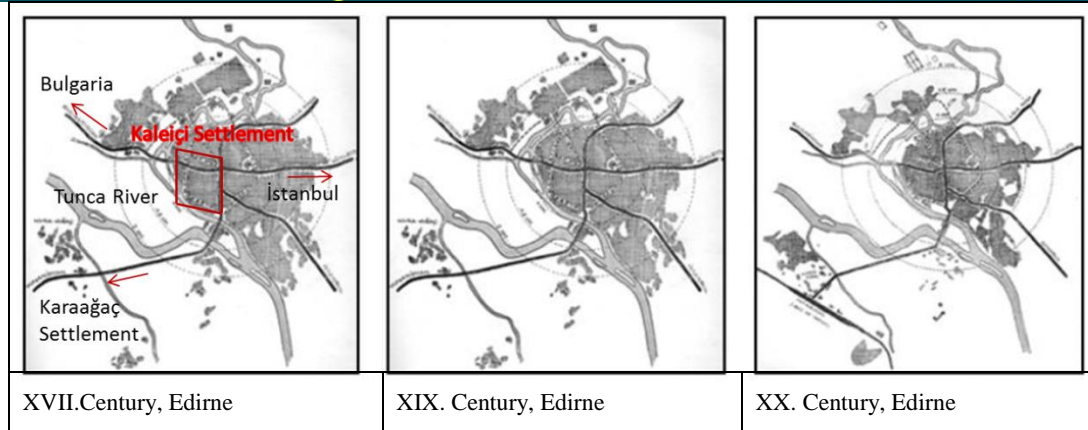

Figure 2. Maps of Kaleiçi in Edirne after XVI. Century (Developed from [4] and [5])

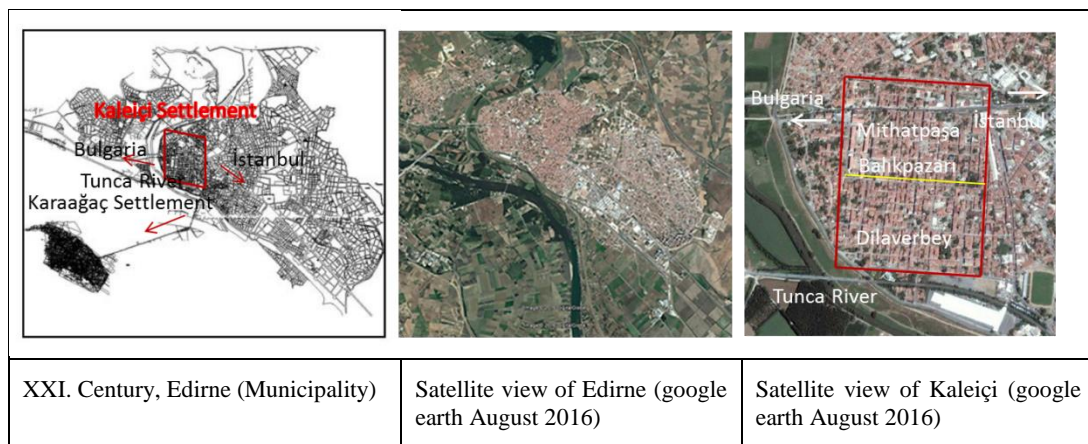

Figure 3. Maps and views of Kaleiçi in Edirne on 2016

### 2.3. Field Study

Survey had been done in May 2010, 2011 and June 2011; existing maps (inventory, zoning and city) are analyzed, photographs were taken and visual examination was done also. Finding out 191 traditional building, their usage were examined. Thus considering with the inventory map, 42 houses, 53 buildings (with different functions), 32 abandoned buildings, 24 parcels (new building or empty), 40 houses (without users; left or for rent; under restoration) are shown up as shown in Figure 4. The questionnaire form is filled within face to face interviews to all users of 42 houses. The questionnaire form contains three parts with 78 questions. In the first part demographical and socio-economic 15 questions were asked such as age, gender, birth place, marital status, educational level, profession and income, family structure, migration, and previously aboded place. In the second part behavioral questions were asked such as satisfaction of house, district and Kaleiçi settlement besides accessibility and necessities of users. 27 questions included abode period and reasons, moving reasons, thoughts about transformation, neighborhood relations, mutual activities, privacy, belonging and safety issues. Satisfaction towards to physical, social, cultural and political dimensions was questioned in the third part. Statistical analysis was done such as SPSS statistical pc programmer, frequency and percentage distribution tables, chi-square independency testes and t-testes.



Figure 4. Revised inventory map of Kaleiçi settlement

### 3.RESULTS AND DISCUSSION

We met 119 of interviewee are designated in 42 traditional houses. The average age is 41 for women and 60 for men; %75,2 of them are born in Edirne or other Balkan countries. Majority is graduated from elementary school as educational level and married as marital status. Income level is low generally; professions are determined as farmer, tradesman, housewives and retired people. Besides the majority living in Edirne, %35,7 of interviewee migrated to the city. Among these users, most of them stated that finding a job is the reason of moving depending on economic issues. Abode period in Kaleiçi is 1-30 years according to Table 1. Being house owner, having easy access, being nearby job and shopping, being cheap and having positive neighborhood are the most popular answers for reason of abode as shown in Table 2. Table 3 gives us a significant info about neighborhood relation: %71, 4 of users prefer to meet their neighbors frequently.

Table 1. Abode period in Kaleiçi

	Freq	%	Cumulative %
1-15	13	31,0	31,0
16-30	12	28,6	59,5
31-45	8	19,0	78,6
46-60	5	11,9	90,5
61 and +	4	9,5	100,0
Total	42	100,0	

Table 3. Frequency of meeting neighbors

	Freq	%	Cumulative %
everyday	16	38,1	38,1
1-2 times a week	14	33,3	71,4
1-2 times a month	6	14,3	85,7
never	5	11,9	97,6
3-4 times a week	1	2,4	100,0
Total	42	100,0	

Table 2. Reasons of abode

	Freq.	%	Cumulative %
House owner, easy access, nearby job and shopping	15	35,7	35,7
Cheap, positive neighborhood, nearby school, marriage	2	4,8	40,5
House owner, easy access, nearby job and shopping, cheap, positive neighborhood	16	38,1	83,3
House owner, easy access, nearby shopping, presence of relatives	4	9,5	92,9
Cheap, positive neighborhood, positive neighborhood, nearby school, presence of relatives	2	4,8	97,6
Easy access, nearby job, cheap, nearby school	1	2,4	100,0
Total	42	100,0	

It is a positive sign not to feel alienation; it is the adoption for the settlement as just the opposite, as shown in Table 4. Furthermore the attached buildings also do not disturb users; they still think that privacy and safety is provided as in Table 5. These are positive signs for unity and ownership as proved in Table 6 and 7. As transformation affects traditional settlements as well, we are chasing an answer for Kaleiçi. %66,7 of interviewee think that Kaleiçi has changed. The change of environment such as streets and houses proves the physical change while family change and migration emphasizes the social change up to the answers shown in Table 8. Users commented about what they want to have in Table 9.

Table 4. Feeling alienation

	Freq.	%	Cumulative %
yes	4	9,5	9,5
no	32	76,2	85,7
don't know	6	14,3	100,0
Total	42	100,0	

Table 5. Feeling uncomfortable for attached building

	Freq.	%	Cumulative %
yes	6	14,3	14,3
no	35	83,3	97,6
don't know	1	2,4	100,0
Total	42	100,0	

Table 6. Obtaining privacy.

	Freq.	%	Cumulative %
yes	36	85,7	85,7
no	5	11,9	97,6
don't know	1	2,4	100,0
Total	42	100,0	

Table 7. Belonging

	Freq.	%	Cumulative %
yes	31	73,8	73,8
no	3	7,1	81,0
don't know	8	19,0	100,0
Total	42	100,0	

Table 8. The reasons of change in Kaleiçi

	Freq.	%	Cumulative %
Death of older family members	5	11,9	11,9
Family change, migration	10	23,8	35,7
Week relations	2	4,8	40,5
Physical change of environment; street, house	9	21,4	61,9
No answer	8	19,0	81,0
Death of older family members Family change, migration Physical change of environment; street, house	2	4,8	85,7
Family change, migration, Week relations, Physical change of environment; street, house	3	7,1	92,9
Week relations, Physical change of environment; street, house	1	2,4	95,2
Family change, migration, Week relations	2	4,8	100,0
Total	42	100,0	

Table 9. Answers for what users want to have

	Freq.	%	Cumulative %
Cinema			
No change	6	14,3	14,3
Kaleiçi needs rehabilitation and prestige	1	2,4	16,7
Kaleiçi must be more clean	4	9,5	26,2
Families must change	1	2,4	28,6
Playground	2	4,8	33,3
No answer	1	2,4	35,7
Migration must end	20	47,6	83,3
Population must be younger	3	7,1	90,5
Hospital	1	2,4	92,9
Public places	1	2,4	95,2
Serenity	1	2,4	97,6
Total	1	2,4	100,0
Cinema	42	100,0	

Majority emphasizes family changes related to migration which is a result of economic problems. People migrate to city for job options that is a major problem of changing world and urbanization. Cultural differences show up when people of different regions of the country come together. Thus the same geography like Thrace and Balkans is not a problem for users; common issues are shared. As a cultural approach, visiting each other on houses, gardens, picnics, public parks, having tea, gathering on special days such as wedding, funeral and prays are the most common shared activities besides communicating at streets in

front of house doors while their children playing as shown in Table 10. %52,4 positive answer can be evaluated as good will to sustain this cultural value. And finally we can mention about unity between neighbors according to Table 11.

Table 10. Communication in front of the door

	Freq.	%	Cumulative %
yes	22	52,4	52,4
no	20	47,6	100,0
Total	42	100,0	

Table 11. Unity with neighbors

	Freq.	%	Cumulative %
yes	23	54,8	54,8
no	8	19,0	73,8
don't know	11	26,2	100,0
Total	42	100,0	

We also observed that the extended family structure of traditional culture transformed into elementary family type and number of users in the houses decreased as a normal result of change and contemporary needs. Local members of Kaleiçi settlement have pleasure generally but they perceive the migrant families in a negative way. As a footnote; before the apartment blocks structured in Kaleiçi at 1970's, high income groups and socially well-known people had lived here. The qualified families of Kaleiçi moved to new settlements in another districts of Edirne while a few of this kind of families still live in Kaleiçi nowadays. Despite the houses need physical renovation such as installment and isolation in terms of comfort obviously, the traditional life style and house form is admired compared with the apartment blocks. Users care about dwelling usage and don't approve the function change of traditional buildings such as hotel, museum or shop usage.

The neighborhood relationships are strong in Kaleiçi and people desire to sustain it. Belonging, security, privacy and satisfaction have high levels in the district. The common usage of garden with the neighbor as mentioned in the traditional daily life is invalid now but guest room usage is still valid. The street especially in front of the door is still used to communicate and socialize. As a result, existing city culture is protected and desired to be sustained with a few exceptions such as recreational areas mostly green open spaces and playgrounds. According to the results that are determined within statistical evaluation, we can claim that users sustain their traditions and daily life routines in Kaleiçi settlement despite transformation; thus socio-cultural sustainability is provided substantially.

#### 4. CONCLUSION

The traditional settlements providing cultural sustainability with its physical and social meanings are at risk to disappear as a result of transformation. Traditional settlements with their users and houses rapidly become old by the changing process observed in social, cultural, economic, politic and technologic dimensions while physically and socially changing user requirements and innovations become insufficient by means of rapid cycle and transportation of knowledge. The traces of life culture in the past besides the requirements in life style of today change the quality of traditional settlements. To put out the grade of these changes becomes important to provide extinction. Even if new settlements and structures designed according to the necessities and technological innovations are needed, the conservation of traditional environments with physical and social dimensions has vital importance in order to hand them down to next generations and provide socio-cultural sustainability.

#### ACKNOWLEDGMENT

This study is developed from doctorate thesis of Damla Atik on "A Suggestion of a Model for the Determination of Physical and Socio-Cultural Changes in Traditional Housing Areas: Edirne City Sample" Trakya University Graduate School of Natural and Applied Sciences Department of Architecture with consultancy of Prof. Dr. Nevnihal Erdoğan whom I feel thankful.

#### REFERENCES

- [1] K. Arı, *Türk Kenti*, YEM Yayınları, İstanbul, 1998
- [2] S. H. Eldem, *Türk Evi Plan Tipleri*, İ.T.Ü. Mimarlık Fakültesi Yayınları, 2. Baskı, İstanbul, 1968
- [3] H. Yürekli and F. Yürekli, *Türk Evi, Gözlemler-Yorumlar (The Turkish House, A Concise Re-Evaluation)*, 1.Baskı, Yapı Endüstri Merkezi Yayınları-111, Mayıs, İstanbul, 2005
- [4] O.N. Peremeci, *Edirne Tarihi*, Edirne ve Yöresi Eski Eserleri Sevenler Kurumu Yayınları, Sayı 6, Resimli Ay Matbaası, İstanbul, 1939
- [5] A. Bayık, "Edirne", İstanbul, 1973

#### BIOGRAPHY

SHE IS GRADUATED FROM YILDIZ TECHNICAL UNIVERSITY DEPARTMENT OF ARCHITECTURE IN 2001. SHE ACCOMPLISHED HER MASTER'S THESIS AND DOCTORAL THESIS IN TRAKYA UNIVERSITY. AFTER WORKING IN A PRIVATE ARCHITECTURAL OFFICE SHE BECAME RESEARCH ASSISTANT IN TRAKYA UNIVERSITY DEPARTMENT OF ARCHITECTURE IN 2005 AND THEN ASSISTANT PROFESSOR IN

DEPARTMENT OF LANDSCAPE ARCHITECTURE IN 2011 INSTRUCTING TECHNICAL DRAWING, AUTOCAD, LANDSCAPE DESIGN PROJECTS AND ELECTIVE COURSES SUCH AS TOURISM AND PLANNING, BUILDING-ENVIRONMENT RELATION. SHE IS MARRIED AND HAS A SON.



# Children's Economic Activities in Agriculture in Turkey

Tugce Ugur<sup>1</sup>, Kasım Eren Tuna<sup>2</sup>, Nermin Bahsi<sup>3</sup>

---

## Abstract

Child labor is a serious problem in Turkey, like other developing countries. Working children are mainly engaged in services, industry and agricultural activities. The Turkish government developed a Time-bounded Policy and Program Framework in 2004 just to decrease the child labor by 2015 and it decreased in the services and industrial sectors but not in agriculture. Because there is a weakness on labor law that it does not require a minimum working age for agricultural or household workers. Child labor works in agriculture, including farming, fishing, aquaculture, forestry and livestock. According the TURKSTAT data, in Turkey, 44 % of working children are engaged in seasonal agricultural activities in 2012. Child laborers work either as an unpaid family members or low waged seasonal workers or both. Gender is important in labor distribution, such as girls are responsible for milking while boys are taking pasture at family business. But at seasonal works such as cotton or hazelnut harvesting; they both do the same work. Unfortunately, most of them are deprived of education; and work in unhealthy conditions, like exposure to hazardous chemicals, walking long distances, and carrying heavy loads. Poverty is the main reason behind children's engagement in economic activities in agriculture because they generate at least 5 to 10 percent of family income. People who live in rural areas have more children than urban areas to get help from them in farming and household activities. In this paper, children's economic activities in agriculture are discussed from the Turkish experience.

**Keywords:** Agriculture, child, labor, Turkey

---

## 1. INTRODUCTION

Child labor is a widespread problem in developing countries. The International Labor Organization (ILO) plays a leading role on the child labor issue and reports that there were a total of 306 million children between ages 5-17 doing some kind of work as of 2008, but about one-third of this is considered permissible work based on national laws and existing ILO conventions. On the other hand, 215 million of these children are classified as "child laborers" because they are engaged in work that poses a threat to their health, safety, or morals, or are subject to conditions of forced labor and it is tragic that more than half of child laborers, some 115 million children, are still exposed to hazardous work. ILO reports also shows that working conditions are often horrendous and in a 2011 publication, ILO reports that every year, about 22,000 children die as a result of work-related accidents [1]. If children at school-age work, this also affects her/his educational and health conditions. When children under age 15 work, their labor time disrupts their schooling and prevents them from attending school altogether. Compounding this, the health of child workers is significantly worse, even accounting for their poverty status, than that of children who do not work; physical stunting among child laborers is very common. In addition, many laboring children are subject to especially cruel and exploitative working conditions [1]. The problem of child labor is also common in Turkey and it is seen that poverty is the main reason leading children to the labor market and it definitely affects their education and health and prevent them from schooling. It is also clear that major parts of working children are related with agricultural activities in Turkey. Due to these, this study aims to show the main conditions of child laborers in agricultural sector and try to indicate how to fight with the main problems related with child labor.

## 2. THE ISSUE AND THE CAUSES OF CHILD LABOR

### 2.1. What is Child Labor?

Some definitions of child labor include only paid work outside the home (i.e., economic or market work), whereas other definitions include unpaid work, family work, and excessive household chores because each form of work may relate to child schooling, health, and well-being [7]. Child labor is often divided into three major categories: work outside the home, family work, and excessive household chores. Children's work outside the home has received the most empirical attention. Work outside the home usually consists of employment in agriculture, services, or industry and can be paid or unpaid. Family work consists of any (usually unpaid) work that children do for the family. Family work is most often agricultural [7], but it also includes work for other family-owned businesses. Finally, household chores include childcare, cleaning, cooking, laundry, shopping, fetching water and wood, and home maintenance. Most children engage in household chores as part of their play routines and as a means of socialization into their culture ([7], [18]). Research into the topic of child labor has experienced a significant upswing in the past two decades [6]. According to the Bureau of Statistics of the International Labor Organization,

---

<sup>1</sup>Corresponding author: Cukurova University, Department of Agricultural Economics, 01330, Sarıcam/Adana, Turkey. [tkaya8789@gmail.com](mailto:tkaya8789@gmail.com)

<sup>2</sup>Cukurova University, Department of Agricultural Economics, 01330, Sarıcam/Adana, Turkey., [erentun@hotmail.com](mailto:erentun@hotmail.com)

<sup>3</sup>Korkut Ata University, Kadirli School of Applied Science, Osmaniye, Turkey. [nerminbahsi@osmaniye.edu.tr](mailto:nerminbahsi@osmaniye.edu.tr)

in 1995 at least 120 million of the world's children between the ages of five and fourteen years did full-time, paid work ([2], [13], [17]). Many of them worked under hazardous and unhygienic conditions and for more than ten hours a day. This is not a new problem. In different parts of the world, at different stages of history, the laboring child has been a part of economic life [2].

## 2.2. Child Labor in Various Countries

Today, it is known that the child labor problem which is on-going almost all over the world for centuries is still exist regardless of the level of its development almost every country in the world. The problem has attracted the international community's attention increasingly because of its' negative effects on child's development [5].

In China; about 7.74% of children aged from 10 to 15 were working in 2010, and they worked for 6.75 h per day on average, and spent 6.42 h less per day on study than other children. About 90% of child laborers were still in school and combined economic activity with schooling [8].

In the 1990s, child labor emerged as an issue of international concern, with particularly strong responses in the United States and some European countries [3].

There are approximately 20–30 million child laborers living in South Asian Countries [4]. The occurrence of child labor is most severe in Nepal and comparable to that of Sub-Saharan Africa where the highest proportion of working children exists. The estimates show that almost one child in three below the age of 15 is economically active in Nepal [4].

Asia and the Pacific countries are the regions which have particularly high child workers (almost 78 million which is about 9.3% of total child population). Also, child labor is most frequent in Sub-Saharan Africa countries (59 million, 21%). More than half of all child laborers live in Asia and the Pacific, but Sub-Saharan Africa has the highest rate of child labor. There are 13 million child workers (8.8%) in Latin America and Caribbean countries. Finally, in Middle East and North American countries, there are 9.2 million child workers (8.4%) [23].

## 2.3. The Causes of Child Labor

Child labor is a complex, persistent and widespread global problem whose roots are deeply embodied in cultural, socio-economic structures of societies ([6], [9]).

Poverty, low levels of education and unconsciousness, increasing levels of population, migration and unplanned urbanization, economic crises and employer bias for selecting child workers, natural disasters, and traditional point of view may be seen as the determining factors of preferring children as labor force [5].

The substantial parts of the problems that the children encounter in Turkey are reflected from the socio-cultural and economic characteristics of Turkey. The problems such as income distribution and regional inequality problems, poverty, employment problems, inequality in social gender roles and accepting children as economic goods affects children directly or/and indirectly. The children are surrounded with some problems like poverty, access to education, social gender inequality, and child labor, tendency to crime, violence and abuse [19].

## 2.4. Child Labor in Agriculture and in Turkey

Children had always been involved in the harvests, their role became increasingly more important as the twentieth century unfolded. In fact, their labor became crucial to the economic success of commercial agriculture as well as to the related industry of fruit and vegetable canning [12].

Reference [15] estimated that over 70% of child labor is agricultural. Worldwide, it is the agriculture sector which has by far the largest share of working children an estimated 70 percent. About 132 million girls and boys aged between five and fourteen work in crop and livestock production, fisheries and forestry. In many cases, participating in household, farm and off-farm activities gives children an opportunity to acquire the skills and knowledge they need if they are to succeed as farmers or in other occupations in the future [10].

In many countries child labor is mainly an agricultural issue. Worldwide 60 percent of all child laborers in the age group 5-17 years work in agriculture, including farming, fishing, aquaculture, forestry, and livestock. This amounts to over 98 million girls and boys. The majority (67.5%) of child laborers are unpaid family members. In agriculture this percentage is higher, and is combined with very early entry into work, sometimes between 5 and 7 years of age. Agriculture is one of the three most dangerous sectors in terms of work-related fatalities, non-fatal accidents and occupational diseases. About 59 percent of all children in hazardous work aged 5–17 are in agriculture [23].

Child labor is most frequent in agricultural sector and it is well above from other sectors (98 million, 59% of total child workers), but there are also significant number of children work in services (54 million) and industry (12 million) sectors. Also, most of these children work in informal economy [23].

Children in Turkey are engaged in child labor in agriculture, including in mobile seasonal work. Children are also engaged in the worst forms of child labor, including in commercial sexual exploitation [22].

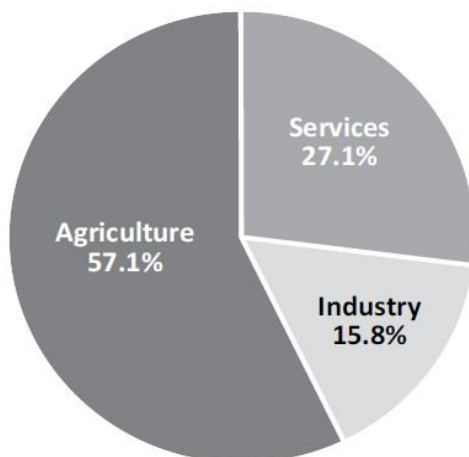

Figure 11. Working Children by Sector, Ages 10-14 [22].

Turkey is encountered with a transition period from rural settlement and agricultural economy to urban settlement and industrial economy. Child employment comes to order as a result of migration trend to the leading city centers, insufficiency of social aid networks and adaptation problems to the urban living. Thus, the number of children increases evidently who work at streets and marginal sectors to increase their family income levels [23].

Based on a review of available information, Table 1 provides an overview of children's work by sector and activity.

Table 3. Overview of Children's Work by Sector and Activity [22]

Sector/Industry	Activity
Agriculture	Production of cotton, hazelnuts, citrus fruits, sugar beets, cumin, peanuts, and pulses
Industry	Production of furniture, bricks,* shoes,* leather goods* Auto repair*
Services	Street work, including selling facial tissue packets or flowers, carrying bundles in market areas, cleaning car windshields, collecting recyclable materials, and begging
Categorical Worst Forms of Child Labor	Commercial sexual exploitation sometimes as a result of human trafficking Used in armed combat by Kurdish militant groups sometimes as a result of forced recruitment*

\* Evidence of this activity is limited and/or the extent of the problem is unknown.

According to the TURKSTAT data large proportion of child labor is employed in rural areas and in the agricultural sector; 44.7 % (399,000 persons) of total employed children were engaged in the agricultural sector.

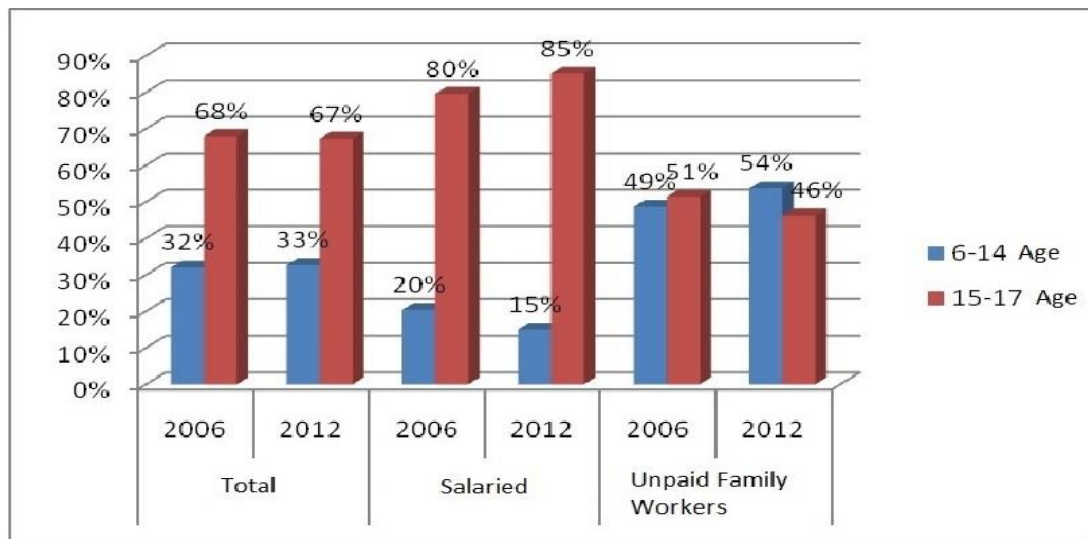

Figure 2. Rate of Child Labor by Employment Status and Age Group [20]

In Turkey, actual average weekly working hours for children who work at an economic sector are critically high. While the actual average weekly working hours for 6-17 aged children are 40 hours, this duration changes dramatically as 45.8 hours for 15-17 aged children (and 28 hours for 6-14 aged children). There are also significant differences between genders on duration of working hours. While the boys work 43.2 hours weekly in average, the girls work 33 hours. But the most tragic durations are seen for the children who do not attend to the school. Actual average weekly working hours for the children who do not attend to the school are 54.3 hours which is above Turkey average [20].

### 3.CONCLUSIONS

In 2014, Turkey made a moderate advancement in efforts to eliminate the worst forms of child labor. The Directorate General for Migration Management, a new coordinating body for the implementation of migration law, including laws related to child trafficking and refugee children, began functioning during the reporting period. In addition, together with the EU, the Government funded a project that included the goal of combating child labor by helping parents of working children to find employment. The Government also trained labor inspectors and law enforcement personnel on issues related to child trafficking and hazardous child labor. However, children in Turkey are engaged in child labor in agriculture, including in mobile seasonal work, and in the worst forms of child labor, including in commercial sexual exploitation. The Government does not have laws that protect children working in agricultural enterprises employing fewer than 50 workers, in small shops employing up to three persons, or in domestic work. In addition, children in the growing Syrian refugee population in Turkey have low access to education and other social services, which leaves them at increased risk of exploitation in the worst forms of child labor [22].

While it is possible mentioning a stable enhancement on basic indicators about children, it is also obvious that the children are encountered with some serious risks and problems [19].

Today, socio-economic transitions such as globalization and poverty that resulted from economic crises unfortunately indicate that the child employment will continue being a vital problem at the near future. Thus, determining the factors which cause these problems must be seen as the vital component to prosper on fighting child employment [5]. Based on the reporting above, suggested actions are identified that would advance the elimination of child labor, including its worst forms, in Turkey (Table 2).

Table 2. Suggested Government Actions to Eliminate Child Labor, Including its Worst Form [22]

Area	Suggested Action	Year(s) Suggested
Legal Framework	Ensure that the law provides protections for children working in small agricultural enterprises, small businesses, and domestic work.	2009-2014
Enforcement	Increase the number of labor inspectors responsible for enforcing laws related to child labor in order to provide adequate coverage of the workforce.	2014
	Increase the penalties for violation of child labor laws to an amount sufficient to deter violations.	2014
	Make publicly available the number of calls related to child labor made via the MFSP hotline and complaints related to child labor made through the Prime Minister's Office Communications Center website.	2014
	Make disaggregated data on the number of investigations, prosecutions, and convictions related to child trafficking publicly available.	2014
Government Policies	Make assessments about the impact of policies on child labor publicly available.	2013-2014
Social Programs	Institute programs to increase access to education and health care for children working in mobile seasonal agriculture.	2014
	Ensure that all Syrian refugees are able to register and that refugees are aware of how to register and why registration is important.	2014
	Expand schools and increase the number of schools and teachers for Syrian refugee children both in refugee camps and in urban areas.	2014
	Make assessments about the impact of existing programs on child labor publicly available	2010-2014

There are some efforts to prevent child employment. But despite these efforts, adequate outcomes still do not emerge and it is mostly due to the flexible labor markets and pervasive deregulation. Child employment must be seen as a result which is produced structurally by employment strategies based on poverty and unsafety. Thus, it is necessary to fight primarily with these strategies for fighting with child employment [21].

## REFERENCES

- [1]. M. P. Todaro and S. C. Smith, Economic Development, Pearson, 12th ed., 2014.
- [2]. K. Basu, Child Labor: Cause, Consequence, and Cure, with Remarks on International Labor Standards, Journal of Economic Literature Vol. XXXVII (September 1999) pp. 1083-1119, 1999.
- [3]. S. Bessell, Influencing international child labour policy: The potential and limits of children-centred research. Children and Youth Services Review, 33(4), 564-568, 2011.
- [4]. S. Chakrabarty, U. Grote and G. Lüchters, Does social labelling encourage child schooling and discourage child labour in Nepal? International Journal of Educational Development, 31(5), 489-495, 2011.
- [5]. H. Efe and S.A. Uluoğlu, Dünyada Çocuk İşçiliğiyle Mücadelede Geleceğe Dair Bazı Öngörüler. Education Science Society Journal / Volume:13 Issue:51 Summer: 2015 Page: 46-72, 2015.
- [6]. S.G. Gumus and G. Wingenbach, The Child Labor Problem in Turkish Agriculture: What Can We Do?, Int J Educ Dev. 2015 March 1; 41: 112-120. doi:10.1016/j.ijedudev.2015.02.001, 2015.
- [7]. D. L. Putnick and M. H. Bornstein, Is child labor a barrier to school enrollment in low-and middle-income countries?. International journal of educational development, 41, 112-120, 2015.
- [8]. C. Tang, L. Zhao and Z. Zhao, Child labor in China, China Economic Review, CHIECO-00941; No of Pages 18.

- [9]. L Eldring, S. Nakanyane and M. Tshoamedi, Defending the vulnerable group: Child labour in the tobacco growing sector in Malawi, child labour in the tobacco growing sector in Africa. Report prepared for the IUF/ITGA/BAT conference on the elimination of child labour, Nairobi, 2010.
- [10]. FAO, 2009. Child Labour and Children's Economic Activities in Agriculture in Ghana. <http://www.fao.org/3/a-al001e.pdf>
- [11]. K. A. Gee, Reducing child labour through conditional cash transfers: Evidence from Nicaragua's Red de Protección Social. *Development Policy Review*, 28/6, 711–732. <http://onlinelibrary.wiley.com/doi/10.1111/j.14677679.2010.00506.x/pdf>, 2010.
- [12]. B. C. Hall, From the West. *Journal of the West*, Vol. 55, No.1, 2016.
- [13]. ILO (International Labour Organization), Child Labor: Targeting the Intolerable. Geneva: ILO, 1996.
- [14]. ILO (International Labour Organization), Joint ILO/UNICEF Paper: Strategies for Eliminating Child Labour: Prevention, Removal and Rehabilitation (Synthesis Document) International Conference on Child Labour, Oslo, Norway. First published October 1997.
- [15]. ILO (International Labour Organization), User guide. Geneva: International Labour Organization; 2006. Tackling hazardous child labour in agriculture. Guidance on policy and practice. Retrieved from [http://www.ilo.org/ipec/Informationresources/WCMS\\_IPEC\\_PUB\\_2799/lang--en/index.htm](http://www.ilo.org/ipec/Informationresources/WCMS_IPEC_PUB_2799/lang--en/index.htm), 2006.
- [16]. ILO (International Labour Organization), Gender equality at the heart of decent work. Report IV of the International Labour Conference; Geneva: International Labour Organization; 2009. Retrieved from [http://www.ilo.org/wcmsp5/groups/public/@ed\\_norm/@relconf/documents/meetingdocument/wcms\\_105119.pdf](http://www.ilo.org/wcmsp5/groups/public/@ed_norm/@relconf/documents/meetingdocument/wcms_105119.pdf), 2009.
- [17]. A. Kebebew, Statistics on Child Labor, *Bul. Labor Statist.*, 3, International Labor Organization (ILO), Geneva, 1993.
- [18]. D. F. Lancy, The chore curriculum. In: Spittler G, Bourdillion M, editors. *African children at work: Working and learning in growing up for life*. Zürich, Switzerland: Lit Verlag, 2012.
- [19]. T.C. Development Ministry, 10th Development Plan 2014-2018. Children's Working Group Report, Ankara, 2014. <http://abdigm.meb.gov.tr/projeler/ois/egitim/020.pdf>
- [20]. (2015) TUIK website. [Online]. Available: <http://www.tuik.gov.tr>
- [21]. (2015) DİSK-AR: Türkiye'de Çocuk İşçiliği Gerçeği Raporu-2015 – DİSK [www.disk.org.tr](http://www.disk.org.tr). Edmonds EV, Pavcnik N. Child labor in the global economy. *Journal of Economic Perspectives*. 2005;19:199–220. Available: [disk.org.tr](http://www.disk.org.tr)
- [22]. DOL (United States Department of Labor), 2014 Findings on the Worst Forms of Child Labor. <https://www.dol.gov/agencies/ilab/resources/reports/child-labor/turkey>, 2014.
- [23]. (2014) ILO- Ankara website. Available: <http://www.ilo.org/ankara/areas-of-work/child-labour/lang--tr/index.htm>

# Influence of Early Ottoman Urban Pattern in Bursa on the Balkan Cities: Skopje Case

Alper Gonul<sup>1</sup>, Selen Durak<sup>2</sup>, Tulin Vural Arslan<sup>3</sup>

---

## Abstract

Bursa, as the first capital of Ottoman State, is a peculiar Anatolian city representing unique urban development of Early Ottoman Era. Various studies have depicted that there was an established Ottoman model for the development of new towns and agreed that the Early Ottoman urban pattern beginning with Bursa influenced the development of Balkan cities that were conquered during the 14<sup>th</sup> century.

This study focuses on the effects of urban development idea of Early Ottoman State on Bursa and Skopje. Skopje is one of the Balkan cities conquered by Ottomans following Bursa. The city of Skopje, displayed similar characteristics with Bursa in terms of its topography and urban pattern. Although their development differed after the Ottoman sovereignty ended, their early development displayed some similarities.

The settlement pattern, during Early Ottoman Era, can be characterized with an existing fortress, a bazaar and neighborhoods called 'mahalle'. These neighborhoods were developed around a nucleus composed of religious, commercial, social and cultural buildings called 'kulliyeh'. Within the scope of this study, the similar urban pattern of Bursa as the first Ottoman capital and Skopje, as one of the earliest Balkan cities conquered by Ottomans is analyzed. There are various studies focusing on Early Ottoman urban pattern in Bursa and Skopje separately. However, the similarities of the development of these two cities are rarely studied. Therefore, this study aims to depict these similarities and the effect of Early Ottoman urban pattern on these two cities.

**Keywords:** Early Ottoman Era, Urban Pattern, Bursa, Skopje.

---

## 1. URBAN PATTERN IN EARLY OTTOMAN ERA

There was an established Ottoman model for the development of new towns. So cities in Ottoman Empire had idiosyncratic social and physical organizations. The buildings and streets were not placed randomly. The city organization in Ottomans comprised of layered structure whose components were religious center, commercial center and housing zone.

The religious center and the commercial center which located out of the fortress, on slope of fortress hill made up Ottoman's city center [1]. The commercial center consisted of bazaar and closed bazaar called 'bedesten'. It was clear that a common settlement plan was applied in Ottoman's bazaar. The producer or seller of the same goods took close places to each other in the bazaar. The members of every profession (blacksmiths, shoemakers etc.) located different parts of bazaar. The commercial and religious center was focus point of Ottoman cities. Besides bazaar, the inns were also a commercial component which strengthened Ottoman economy. In Ottoman cities the main commercial axis which called long bazaar, began from 'bedesten'. The long bazaar was a place which all kinds of goods and services were sold.

Neighborhoods (Mahalle) which located around a religious building or a small bazaar were the basic housing settlement of the Ottoman city [2]. 'Mahalle' was a social, cultural and physical unit which consisted of people who were responsible of each other's behaviors and social, cultural solidarity [3]. People who had same profession lived in neighborhoods (Mahalle) which identified with their profession again. (For example neighborhood of blacksmiths or shoemakers) However there were non-Muslim neighborhoods where non-Muslim people lived. The coexistence of people belonging to the same ethnic group didn't break their relationship with other people in the city. So the neighborhoods had never been autistic units.

---

<sup>1</sup>Corresponding author: Bursa Technical University, Department of Architecture, 34220, Yildirim/Bursa, Turkey. [alper.gonul@btu.edu.tr](mailto:alper.gonul@btu.edu.tr)

<sup>2</sup>Uludag University, Department of Architecture, 16059, Nilufer/Bursa, Turkey. [selendurak@gmail.com](mailto:selendurak@gmail.com)

<sup>3</sup>Uludag University, Department of Architecture, 16059, Nilufer/Bursa, Turkey. [tulinv@yahoo.com](mailto:tulinv@yahoo.com)

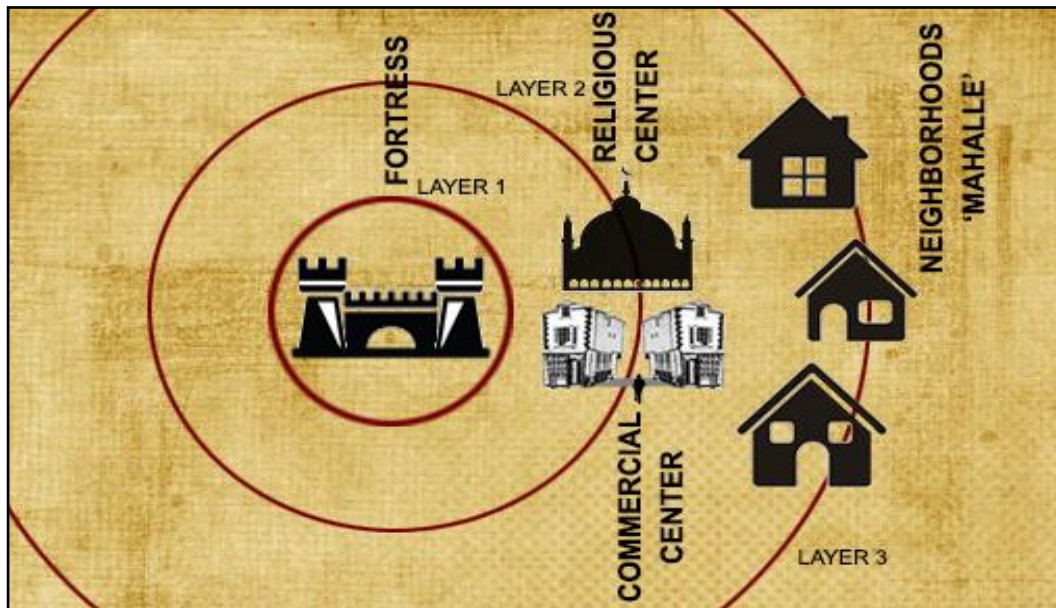

Figure 12. Urban Layers of Early Ottoman City

The residential part of the Ottoman towns separated from commercial areas. The quite modest form of the houses was the result of functional action. The houses in same character generated narrow and uneven roads. In Islamic cities, dead end streets were special roads which reached from main lines to houses [4]. There was no planned square in Ottoman cities. Mosques, bake houses, fountains were places where people meet.

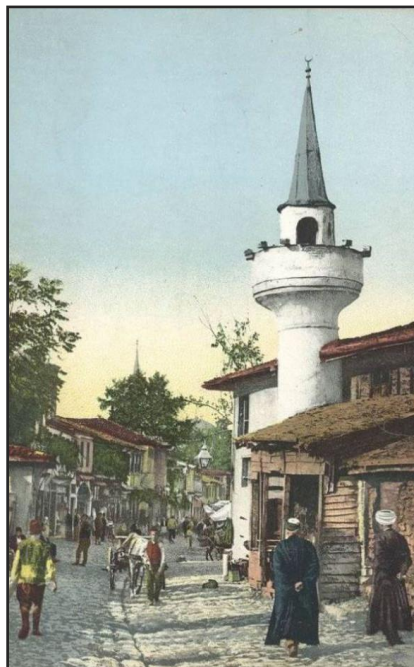

Figure 2. A View from Early Ottoman City [5]



## 2. BURSA CITY STRUCTURE IN EARLY ERA OF OTTOMAN EMPIRE

### 2.1. Bursa in Ancient Times

Bursa's history depends on to Romans, Byzantines. Bursa was conquered by Orhan Gazi (the second monarch of Ottomans.) in 1326. The city of Bursa located in a limited area in the fortress before the Ottoman Conquest. There were a library, stadium, bath, hippodrome, and colonnaded area (just like all big Roman cities) in Bursa in Roman era [6]. The most important development in Byzantium era was building an inner fortress next to the palace. The palace was used in Ottoman era as long as Bursa was the capital of Ottomans.

### 2.2. Bursa During Early Ottoman Era

After Orhan Gazi had conquered Bursa city, it was decided that the inner part of the fortress was remained and new settlements for providing house to new Turkish tribes in Anatolia were established out of the fortress. On the other hand inns, baths and almshouses, mosques were built from Çakırhamam to Setbaşı in Orhan Gazi era. The buildings which were made by Orhan Gazi determined the main axis and center of Bursa city. The city center was a strategic focus which was the end of trade routes.

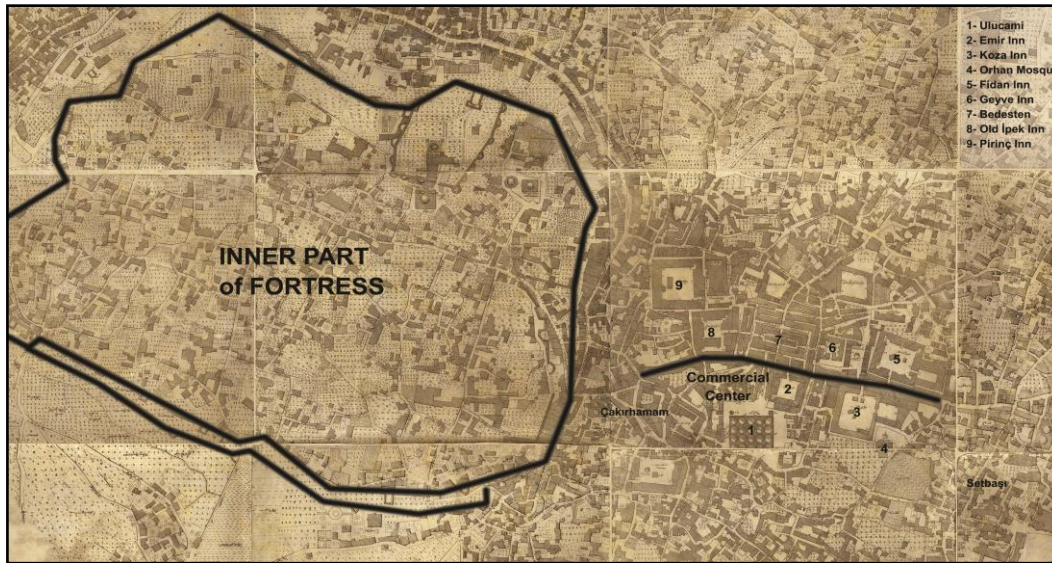

Figure 3. The Buildings which were constructed by Orhan Gazi in Suphi Bey Map-1862 [7]

Monarchs (Sultans) who ruled the Ottomans after Orhan Gazi; continued to construct "Kulliye" in different part of Bursa city. This kind of buildings contributed to developing of the city. So and so, residential areas began to exist around "Kulliye" and city pattern of Bursa shaped. On the other hand Monarchs (Sultans) who ruled the Ottoman after Orhan Gazi constructed new buildings such as inns, bedesten (closed bazaar), and shops on the trade line to develop and strengthen the trade center.

The main dwelling units were neighborhoods in Early Ottoman era Bursa. The neighborhood was generally established around a bazaar or religious building. Neighborhoods in Ottomans were a whole unit with its activities and spiritual properties.

People in same neighborhood were interdependence with same religious belief, having same profession and other features which separate them other neighborhoods. But there were no wide squares for people's meeting just like European cities. Thus churches, mosques and bazaars were common places for inhabitants of the neighborhoods. These places were used for different aims if it was necessary [8].



Figure 4. A residential area in Bursa which remained from Ottomans [9]

The narrow and irregular streets went towards to mosque, bazaar or church in neighborhood. There was only one main road one neighborhood to another neighborhood. This case was the proof of separated neighborhoods.

As well as 'Kulliye', the places where were settled by dervishes were established as neighborhood too. The travelling dervishes played a major role in Ottoman's conquest policy. Travelling dervishes had visited the places to conquer and prepared mentally

to local people for conquest. These Ottoman's conquest policy provided to emerge new kind of mosque which shaped as 'Reverse T' plan type.

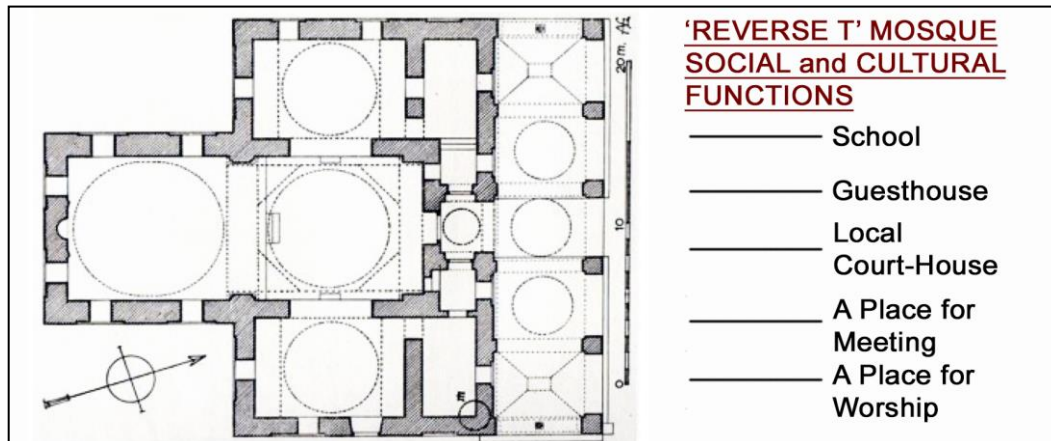

Figure 5.A Reverse T Mosque Example [10]

### 3.SKOPJE URBAN PATTERN IN EARLY OTTOMAN ERA

#### 3.1.Skopje City and Geographical Features

Skopje is the capital of Macedonia and located the north part of the country. Geographical features of the city have influenced the city character. First of all the city of Skopje located in a valley which consisted of surrounding mountains and cross rivers. Vodno Mountain on south, Suva Gora Mountain on southwest and Skopska Crna Gora Mountain on north encircled the city of Skopje.

The ground of Skopje occurred with alluvium which deposited by rivers such as Treska, Lepenec, Sereva and Vardar. Thus the district of Skopje has had fertile lands and has been a suitable place to settle since ancient times.

The humid Subtropical Climate is effective in the region. So it is hot, humid in summer and usually mild to cool in winter.

Dominant wind direction is from north to east just like flow direction of Vardar River.



Figure 6.Location of Skopje City [11]

#### 3.2.Road Networks of Skopje

The Valley of Skopje has been used as living space since ancient times. The Via Egnatia was a road which connected Roma to Istanbul. The road crossed the Roman provinces such as Macedonia. In this context, the Skopje Valley which located around Via Egnatia Road had a strategic position.



Figure 7. Position of Egnatia Road [12]

In 1928 Map, we can observe that local transit highways crossed via Skopje. So the city of Skopje located another important trade route from Middle-East Europe to Salonika (Aegean). On the other hand, the main highways on Skopje Valley followed Northwest-Southeast direction (Flow direction of River Vardar).

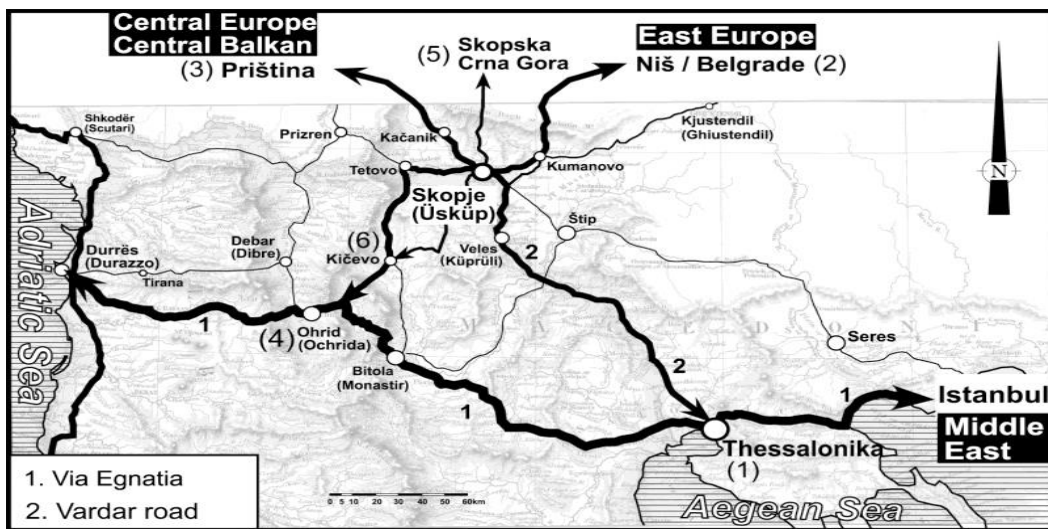

Figure 8. Road Network of Skopje in 1928 Map [13]

### 3.3. Urban Fabric of Skopje in Early Ottoman Era

According to Stern, the fabric of Islamic cities is different from the cities in Europe because of lack of square and municipality [14]. Thus lack of square surrounded with public buildings caused a different urban structure in Ottoman cities.

Before Ottoman Empire, the city of Skopje was under the rule of Byzantium, Bulgarian and Serbia. In spite of having limited knowledge concerning this period, it was thought that the city of Skopje was composed of four urban zones.

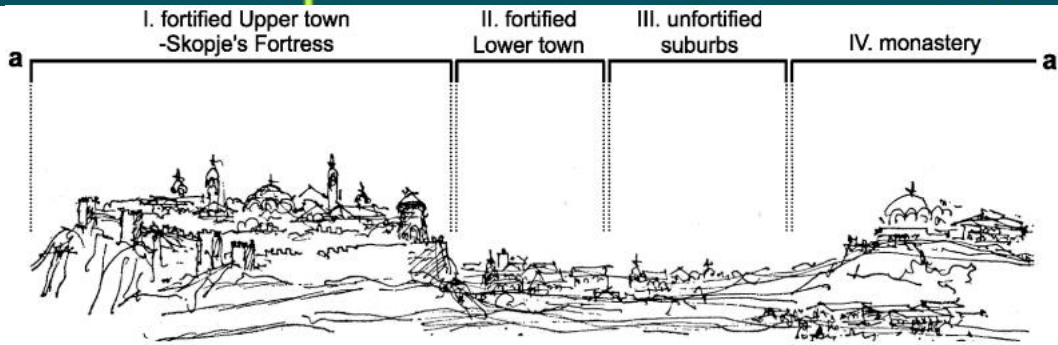

Figure 9. Urban Zones of Skopje before Ottomans [15]

After the city of Skopje had been conquered by Ottomans in 1392, the city developed according to Ottoman's urban principle and character. According to these principles the city of Skopje consisted of three urban layers:

- The fortress which was built on fortress hill
- The main mosque and the bazaar (consisted of inns, bedesten and shops) which was built on east slope of fortress hill
- Neighborhoods (Mahalle) which surrounding the city center

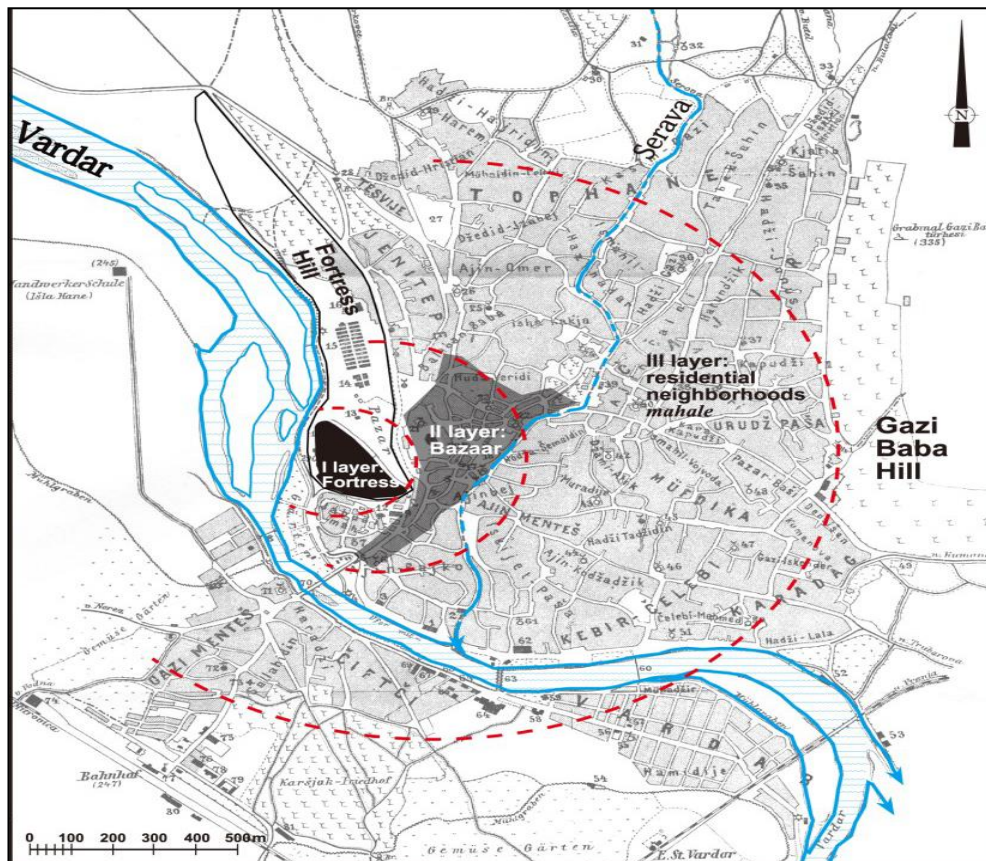

Figure 10. Urban Zones of Skopje in Early Ottoman Era [15]

The city of Skopje in Early Ottoman Era was located between Fortress Hill on West and Gazi Baba Hill on East. Sereva River flowed parallelly to main axis of city (long bazaar) between these hills and disembogued to River Vardar. The geographic features of fortress hill made here a perfect defense point.

Ottoman Bazaar played a major role in development of Skopje. The buildings such as inns, mosques, baths, Bedesten which were built out of the fortress formatted the religious and commercial focus of the city.

Also neighborhoods were situated encircling the religious and commercial center. The neighborhoods where houses located on were living spaces for people who had same cultural, ethnic specialty. The neighborhoods had a small center which consisted of a mosque, a bake house or a church.

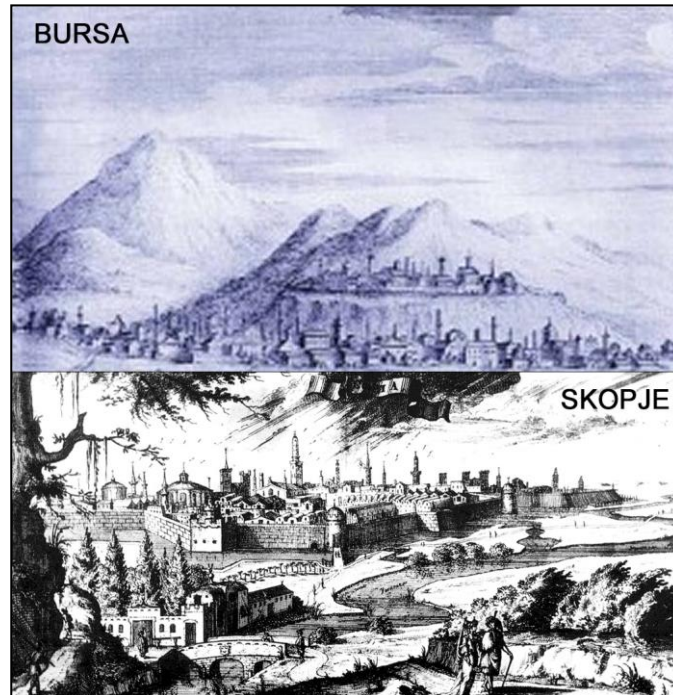

Figure 11. Comparison of Bursa and Skopje [16a and 16b]

## 4.RESULTS

The Ottoman urban strategy which can be observed in Bursa urban fabric in Early Ottoman Era such as a developed urban zone (consisted of bazaar and main Friday Mosque) in the city center and residential neighborhoods around community centers (mosques, churches, school etc.) in the outskirts of the city also constituted the main character of Skopje City. Moreover facilities such as Bedesten (special buildings for trade), inns, baths, and mosques are common components of bazaar of Bursa and Skopje. In addition to all of these, the construction of special commercial building Bedesten in Skopje bazaar in 1438 following Bursa (1400) was supporting fact that Bursa urban pattern influenced Skopje city structure in early Ottoman Era.

One of the prominent buildings of Early Ottoman Era was 'T Shaped Mosques' which were used multipurposely for worship, meeting, education, judgment or hospitality. This type of buildings were found initially in Bursa and around. Besides Bursa, 'T Shaped Mosques' could also observed in the cities which ruled by Ottomans such as Edirne, Filibe, Skopje.

Finally it can be said that Bursa urban fabric set an example for Skopje city center in the Early Ottoman Era. So there is a strong influence of Bursa urban development on Skopje city center. It is possible to see these effects in the historical city centers even today.

## REFERENCES

- [1]. Ö.L. Barkan, *Kolonizatör Türk Dervişleri (Colonisator Turkish Dervishes)*, Ankara, Turkey: Hamle Yayınları, 1975.
- [2]. Ö. Ergenç. "Osmanlılarda Esnaf ve Devlet İlişkileri (Merchants and Government Relations in Ottomans)," *Tarihte Türk Devletleri*, vol. 2, pp. 627-631, 1987.
- [3]. O.N. Ergin. *Türkiye'de Şehirciliğin Tarihi İnkişafı (The historical development of urbanization in Turkey)*, İstanbul, Turkey: İstanbul University, 1936.
- [4]. D. Kuban. *Türk ve İslam Sanatı Üzerine Denemeler (Essays on the Turkish and Islamic Art)*, İstanbul, Turkey: Arkeoloji Sanat Yayınları, 1995
- [5]. (2016) Neighborhood Units [Online]. Available: [www.dunyabizim.com](http://www.dunyabizim.com)
- [6]. P.D. Menthon. *Olympe de Bithynie*, Paris, France, 1935.
- [7]. 1862 Suphi Bey Map- Archive of Bursa Metropolitan Municipality
- [8]. M. Özer. *Üsküp'te Türk Mimarisi (Turkish Architecture in Skopje)*, Ankara, Turkey: Türk Tarih Kurumu, 2006.
- [9]. (2016) Neighborhood Unit [Online]. Available: [www.tgdturkey.com](http://www.tgdturkey.com)
- [10]. (2016) Bursa Orhan İmaretı [Online]. Available: [www.sehrinesesver.com](http://www.sehrinesesver.com)
- [11]. (2016) Skopje Physical Map [Online]. Available: <http://www.maphill.com/macedonia/skopje/cair/skopje/maps/physical-map/>
- [12]. (2016) Egnatia Road [Online]. Available: [https://tr.wikipedia.org/wiki/Egnatia\\_Yolu](https://tr.wikipedia.org/wiki/Egnatia_Yolu)
- [13]. David Rumsey Map Collection [Online]. Available: <http://www.davidrumsey.com/>
- [14]. S.M. Stern. *The Constitution of the Islamic city, The Islamic city– Papers on Islamic History*, ed: Hourani, A.H. and Stern, S.M., Bruno Cassirer Oxford and University of Pennsylvania Press, 1970.

- [15]. A. Krstikj. "Values of the historic urban form of Skopje's old bazaar based on analysis of the Ottoman urban strategy." Doctoral Dissertation, Osaka University, Japan, 2013.
- [16a]. (2016) Bursa Engraving [Online]. Available: <http://en.bursa.bel.tr/wp-content/uploads/2011/05/2-300x140.jpg>
- [16b]. (2016) Skopje Engraving [Online]. Available: [www.wikimedia.org](http://www.wikimedia.org)

## BIOGRAPHY

**Alper Gonul** was born in Bursa, Turkey. He received his bachelor's degree from Architecture Department of Uludag University, Bursa, Turkey, in 2014. He is currently studying for an architecture M.Sc. degree in Uludag University. Mr. Gonul's major fields of study are Ottoman City Patterns in Anatolia and Balkans. He is currently is a research and teaching assistant at Bursa Technical University.

**Selen Durak** was born in Bursa, graduated from Middle East Technical University as a bachelor of architect in 1996, completed Master of Architecture in Uludag University Architecture Department in 2003 and PhD in Middle East Technical University in 2010. Now working as an associate professor in Uludag University Faculty of Architecture. Her field of interest is universal and inclusive design, children's environments, history of architecture and cultural heritage.

**Tulin Vural Arslan** was born in Bursa, graduated from Middle East Technical University as a bachelor of architect in 1996, completed Master of Architecture in Middle East Technical University in 1999 and PhD in Istanbul Technical University Faculty of Architecture in 2005. Now working as an associate professor in Uludag University Faculty of Architecture. Her field of interest is architectural design, design of shopping centers and the development and transformation of commercial districts in historic city centers.

# An Anti-Colonial Approach to Sustainable Development: Economic Structural Adjustment and Women in Agriculture in Africa

*Aslı Ege<sup>1</sup>*

---

## Abstract

*This paper is an effort to explore within a historical perspective, the colonial character of the unequalitarian economic process imposed on the African continent by economic structural adjustment programs (ESAPs) and the implications of this process on women in agriculture, all those in relationship with sustainable development. Thus an anti-colonial approach to sustainable development is proposed where the democratic aspect as regards social justice that is based on an egalitarian relationship in between North-South/centre-periphery and in between genders, remains the most important.*

**Keywords:** *Agriculture, Colonialism, ESAPs, Sustainable Development, Women.*

---

## 1. INTRODUCTION

Sustainable development may be understood as the capacity to render the world and its resources enduring for the generations to come, which means that the responsibility for the following generations would be on the ones before them. On the other hand sustainable development should be understood within a multi-dimensional and inter-disciplinary approach to development, diverging from history to democracy, from economy to gender and etc. In this perspective each dimension is in relationship with the other. This paper aims at pointing out such a relationship within the framework of an anti-colonial approach to sustainable development around the subject-matters of economic structural adjustment and women in agriculture in Africa.

As regards, under the second section after introduction (“From a state driven economy to structural adjustment”), the paper proceeds from Africa’s economic under-development as continues under economic structural adjustment programs (ESAPs). Under the third section (“Structural adjustment, colonial division of labor and the problematic of democracy”), the colonial division of labor, conditioning centre-periphery/North-South relations are treated. This is in order to explain the historical background conditioning ESAPs, this point being elaborated within the problematic of “democracy” as linked to “social justice”. From there, the fourth section (“Structural adjustment and agriculture in Africa: the colonial heritage”) specifically focuses on agriculture, again within an historical perspective. The relationship in between the colonial heritage and the ESAPs are treated in this section as it applies to agriculture. Finally, the fifth section (“Consequences of economic structural adjustment on women in agriculture in Africa”) explores what may be called “gender division of labor”, as a reflection of the colonial ideology and as implied by ESAPs. As follows, in the “results and discussion” section, “an anti-colonial approach to sustainable development in Africa” is proposed within overall remarks and critics which provide pathways for further discussion. Finally, the conclusion offers some analytical tools of reflection, along with the proposition that an anti-colonial approach to sustainable development, should be understood within an egalitarian economic development in between North and South, centre and periphery, and in between men and women. This would be based on equal distribution of resources thus on “democracy” from the aspect of social justice.

## 2. FROM A STATE DRIVEN ECONOMY TO ECONOMIC STRUCTURAL ADJUSTMENT

During the first decade and half of independence, influenced by the dominant Keynesian paradigm, African states intervened to correct market failures and stimulate the process of industrialisation [1]. Briefly, after independence, most African States followed state-driven development through Import-Substitution Industrialisation (ISI). “*African leadership believed that the private sector was too backward and that government had to play the dominant role... This belief translated into the socialist approach to development in which all aspects of economic development were primarily government-driven*”([2], p.56). This model succeeded in positive growth rates in a variety of African economies.

However, although the authoritarian model based its legitimacy on continued accumulation, positive rates of growth and the provision of public welfare, African societies entered a stage of profound crisis in the late 1970s/early 1980s as a result of the recession in the world market and the structural problems of the state capitalist model of development ([3], p.63). In this development, distribution of resources as opposed to production, class differentiation and rent seeking played a major role. In

---

<sup>1</sup>Corresponding author: Marmara University, French Speaking Department of Public Administration, 34820, Beykoz/Istanbul, Turkey.  
[asli.ege@marmara.edu.tr](mailto:asli.ege@marmara.edu.tr)

short, economic development did not last long and did not bring political democracy. Large-scale public expenditure was seen as way to for dominant groups to siphon off public resources and the state provided infrastructure and social services, aimed the loyalty of the subordinate groups of the anti-colonial alliance ([3], p.60,65).

Thus, with the unefficient allocation of resources and the global oil crises, African economies failed to advance with the consequence of IFIs to intervene into African economies. Within this context, economic structural adjustment programs (ESAPs) of the international financial institutions (IFIs), precisely of the World Bank and the International Monetary Fund (IMF) have first been put into implementation in 1980s and promoted adjustment within a capitalist model of development. As such, *“radical reform programmes, influenced or initiated by the IMF and the World Bank, have been introduced to check the unprecedented economic decline”* ([3], p.64). When this model faced difficulty in achieving its goals, IMF and the WB claimed in response that “adjustment is working” in countries that followed its prescriptions. Thus, while *“there were 29 African countries under IMF advice by 1990; by 1994, only 20 African countries were performing on track, while 11 were off. The ratio worsened during the late 1990s, according to the IMF, with 16 on track and 14 off track.”* From the early 2000s, the IMF began publishing lists of good African countries that stayed the structural adjustment course, and those that were, as the Fund put it, ‘off track’ ([4], p.83)”.

It may be asserted that the neoliberal paradigm of economic structural adjustment which aimed at economic growth has not been a healthy prescription for the African economies. If it is to consider that most African economies have been under economic structural adjustment in 1980s, whereas only 10 out of 34 Sub-Saharan African (SSA) countries experienced negative per capita GDP growth rates between 1965 and 1980, only nine registered any positive per capita GDP growth rate between 1980 and 1987 [5]. This caused sharp declines in their major macro-economic and social indicators, with industry falling from 13.5 per cent in 1965-73 to 0.7 per cent 1980-89 [5]. Ironically, fastest growing African economies increased their deficits while the medium- and especially slowest-growing economies cut their fiscal deficits furthest ([4], p.84). In short, the objective of growth in ESAPs did not occur in many African countries.

### 3.STRUCTURAL ADJUSTMENT, THE COLONIAL DIVISION OF LABOR AND THE PROBLEMATIC OF DEMOCRACY

*“Today, Africa is still getting progressively poorer, with per capita incomes in many countries below those of the 1950s-60s era of independence... Most Sub-Saharan African countries suffered an increase in the percentage of people with income of less than \$1/day during the 1980s and 1990s”* ([4], p.2). *“By the early 2000s, the debt remained unbearable for at least 21 African countries, at a level at more than 300% of export earnings”* ([4], p.33). Overall, *“The continent’s share of world trade declined over the past quarter century, but the volume of exports increased”* ([4], p.49). African countries continue sending out raw materials and there is no change in the marketing of basic products, especially in the agricultural sector. As such the continent’s economic marginalization within the global processes has occurred as well through ESAPs which has to do with the colonial division of labor. Especially, *“the withdrawal of state support for a fledgling industrial sector, state or private, meant abandoning the effort to lay a foundation for an alternative to the colonial and neocolonial division of labour”* ([6], p.88).

The colonial division of labor foresees an unequalitarian relationship in between the centre and periphery both on the international and national levels. The marginalization of African economies within the global economic processes explains the colonial division of labor on the international level. On the national level, “the liberalisation program of 1980s under structural adjustment has played a similar role, where the economic power once being the “stateclass” to now includes merchants and concessionaires (ponteiros), but with direct links with the “stateclass” ([7], p.17). In this framework, African wealth is drained by individuals who are not *“directly involved in producing wealth but only in rendering auxiliary services – civil servants, merchants, soldiers, entertainers, etc - These people do not reinvest in agriculture or industry...([4], p.5)”* to generate growth and raise production to a new level altogether. Precisely, ESAPs benefited those who are at the centre against the periphery both on the national and international levels, where the centre on the national level is in cooperation with the center on the international level, which is again another indication of the colonial division of labor. Inspiring from a socialist approach to democracy, this is against social justice and against equal distribution of resources. Those facts make it impossible to develop the resources of the continent.

Consequently, *“instead of an organic middle class and productive capitalist class, Africa has seen an excessively powerful comprador ruling elite”* ([4], p.6), in the continuation of North-South power relations. As regards North-South power relations, through sharpening local differences under tribal identification, colonial rule was maintained by the use of force and the clientelist structures of indirect rule to dilute the militancy of the anti-colonial opposition ([3], p.58). In the post-independence period, this time it was U.S. and Russia who took over and only a handful of African leaders have voluntarily left power after decolonization (Nyerere of Tanzania, Kaunda of Zambia etc.) ([8], p.16). In this period, while *“several ideologies, ranging from African socialism and humanism to negritude and authenticity, were propagated by new rulers ([3], p.62)”* in nation building; military and one-party dictatorships were supported by U.S to help control dissent in African societies. In short, as regards liberal ideology, decolonization did not bring plural forms of politics and pluralist democracy either. *“The nationalist elites ruled through the state monopolies and the colonial patronage networks to consolidate and expand their economic and political powers ([3], p.60)”*.

ESAPs put into implication within the IFIs, reflect the same logic of the colonial division of labor because they work rather for the interests of multinational companies, depending on the reliability of the local elites, against the interests and the popular support of the masses. Shortly, ESAPs did not take on a democratic character because they benefit elites and consequently because of the lack of support of the civil society as regards the cuts in the social sector such as education and health services. On the political level, *“these situations have lead to loss of power, instability and /or increased military repression ([9], p.98)”*, in some of the African countries. Despite this ESAPs failed once again to bring democracy as they were guided by *“a*



*strong presumption in favour of the effectiveness of authoritarian governments in carrying through adjustment programmes even if they were not regarded desirable in any wider sense*" ([10], p.109). In this sense, *"compliant African states and militaries have offered Washington far more than checks to radical Islam; they were increasingly seen as a counter-weight to rival core powers in the North and unruly states and leaders in the South"* ([4], p.98). Still today, within the colonial division of labor and the problematic of democracy versus external "intervention", African states are seen as more politically compliant as well as more militarily dependent.

Overall, ESAPs represent pre-existing alliances resulting from the colonial division of labor and results in the erosion of political capacity by external conditionalities. In this sense, *"nationalism is the potentially most dangerous ideological and social force confronting ESAP – as - it draws on the history of resistance to foreign political domination"* ([6], p.87). Thus, economic structural adjustment has necessarily to do with the problematic of democracy and it creates problems especially for the nationalist coalition.

Lastly, Bretton Woods Institutions need themselves serious democratization. *"Within the World Bank, nearly fifty Sub-Saharan African countries are represented by just two directors, while eight rich countries enjoy a director each and the US maintains veto power... - and that the US appoints the Bank president - The leaders of the Bank and IMF are chosen from, respectively, the US and EU, with the US treasury secretary holding the power of hiring or firing"* ([4], p.90). On the other hand IMF and the WB is not politically and economically neutral as epistemologically, the international economy can not be regulated by "objective", quantitative, short term analysis, excluding the human factor. ESAPs are a top down process with external conditionalities imposed on local authorities, which exclude those who are left out, who are in fact subordinate large classes of workers and peasants, women and children, reminding once again the colonial division of labor.

#### **4.STRUCTURAL ADJUSTMENT AND AGRICULTURE IN AFRICA: THE COLONIAL HERITAGE**

Before structural adjustment African economies were geared by import substitution which was as well the case for agricultural products through state marketing boards. However, the neo-liberal ideology of IFIs blamed the heavy state involvement in the African economy for Africa's economic crises by the end of 1970s, defending that this has led to marked inefficiency. But in line with the colonial heritage and division of labor, Africa's marginalization operated as well through ESAPs in line with the prescriptions of the World Trade Organization who foresaw export oriented production for development. The provision that production for export necessarily creates prosperity is still the most important myth of neoliberal economics. Therefore, ESAPs of the IMF and World Bank resulted, as in the colonial economy, in a shift in African economy from subsistence crops to export crops for external production, going to industrialized nations.

In fact, cash crop production for exportation in Africa was first encouraged by the colonizing forces in exchange for the importation of European goods as part of the exploitative nature of the trade relations of the colonial ideology. *"In both French and British Africa, the emphasis was to expand cash crop production using existing modes of agricultural organization... and surplus labor was available from males since women cultivated most food crops"* [8]. Since then and within the economic structural adjustment programs, African economies became depended on the rise and fall in global demand for those primary goods. Thus, state driven efforts for the development of an home grown African industry have come to an end; thus ending by Africa's marginalization, especially as market principles operated in setting agricultural and other prices.

In addition, African states were forced to depend solely on a few cash crops for exportation, undermining biodiversity and productive efficiency. This led to inadequacy of the food reserves and subsequently, chronic malnutrition and famine, leading to dependency. As regards dependency, even cash crop production such as cocoa in Africa is in a disadvantaged situation by Western firms who develop outright synthetic substitutes and/or adopt technological improvements in production [8]. However, pre-colonial agricultural methods continue in Africa, unable to alter small scale production and Sub Saharan Africa still depends on agriculture as a growth strategy. As structural adjustment has a neo-liberal agenda to let the markets determine prices, the main damage for African farmers, results from the long-term decline in primary product price trends for most cash crops such as coffee, tea and cotton.

Overall, the crucial aspects of the reforms such as fluctuations in prices, the withdrawal of subsidies from farm inputs, escalating costs of production, and general levels of inflation that affect consumption of traded goods, made the peasants suffer the negative consequences of structural adjustment ([3], p.66). ESAPs which typically mean privatization, deregulation, budgetary constraints, trade and financial liberalization, thus rather misconceived policy measures often harm poorer people and benefit international traders ([4], p.37). Even where growth did occur, *"The winners have been net surplus producers of agricultural products among rural households, particularly those with export crops, while the losers have been net consuming poor households and the urban poor"* ([2], p.59). Such consequences point to the colonial division of labor under structural adjustment as well in the agricultural sector. As regards, women in agriculture have been the ones who suffered most from the prescriptions of the ESAPs both as regards their status and living conditions.

#### **5.CONSEQUENCES OF ECONOMIC STRUCTURAL ADJUSTMENT ON WOMEN IN AGRICULTURE IN AFRICA**

In ancient Africa, women held considerable power both in society, government and economy. Women had a say in executing their own affairs and were privileged as owners of land in agriculture. With colonisation, *"their vital role in food production was overshadowed by the more lucrative male-dominated cash crop cultivation for the international market"* ([11], p.10). As colonial authorities *"were accustomed to the norms of female domesticity in European societies"* ([12], p.185), they discriminated against women and established schools and other centres of formal education exclusively for men ([13], p.107), including technical training and assistance to men in cash crop production, while ignoring women farmers. For most African

women (with the exception of some urban women), the colonial period was characterized by significant losses in both power and authority.

Women's activism was at the forefront in the process of decolonization but because of their undermined situation in status during colonization period, for African women, decolonization has meant the transfer of power from one group of men to another. As was the case in the colonial period, women still lack tangible and intangible assets most essentially education as regards agriculture and if they are to have a bargaining power. This results again in women's under-representation with the consequence of the loss of power. As applied to ESAPs, women continued to work on land, but their control over the products of their labor declined, reflecting the actual situation.

Within this framework, starting from the eighties, gender dimension of economic structural adjustment has become more mainstream, especially within the framework of the "United Nations' Decade for Women (1975-85). By 1990s, as the researches on factors of food security for the poor and ecology were expressed more seriously, the social justice and feminist dimensions of adjustment attracted even more attention. It was clear that market opportunities at the center of structural adjustment did not appeal to women. Precisely, women lacked the necessary assets such as land, input intensity, including that of labour, access to capital, technology and information thus responsiveness to market signals which prevented them from standing shocks and achieving productivity.

On the other hand, as regards women in agriculture, one of the main pitfalls of the neo-liberal ideology was not to be able to foresee the gender division of labor which occurs in the economy as well as in the household. This reality challenged the assumption that the households are a unity. The neo-liberal ideology of the economic structural adjustment programs avoided the linkage between the paid and unpaid economy at the domestic context in the name of market efficiency. Precisely, when the state withdrew from economy to meet budget austerity measures, it was especially poor rural women who had to pay the burden for the cuts in social services that the state once provided. Also, as men left/migrated for payed work opportunities in the urban sector - off-farm employment provided opportunities for men but not for women - women's work load both in productive and reproductive sectors doubled. As this was the case, women's domestic workload such as housework and child care doubled and their time were considered infinitely flexible. Structural adjustment did not acknowledge women's reproductive roles - including food crop production for the household - as those roles were not recognized having a price value in neo-liberal ideology.

On the other hand, at the same time with male immigration to towns, women-headed households and feminization of agriculture occurred. However, "*women have not been able to become viable food and export farmers because they are unable to make their farms productive given the low returns, high labor costs, and pressures to turn over productive resources to male control*" ([14], p.17). For example, women owned only small lands to cultivate as most customary law prevent women from land tenure. Thus women also lacked access to credit because most financial institutions work on the base of ownership. In addition, without secure title to land, women have often been denied membership of cooperatives and other rural organizations[15].

All those factors undermine women's productivity and they have poor investment opportunities to be able to use instruments such as fertilizers and equipment. For example, as women could not use fertilizer, their productivity declined. Evidence for Kenya is considerable showing that "*if women were to use the same resources as men their productivity would increase by about 22 percent*" [15]. As such, women are to loose control of their bargaining power because they lack resources. This is an indication of gender division of labor which explains as well poor rural women's subordination in the agricultural sector. Gender division of labor operates as well in between rich women and poor women, as inequality and poverty are unsperately inter-related and as the continuation of the colonial division of labor.

It is though possible to challenge this colonial division of labor. As such, if small households could become less gender-skewed between women and men, greater productivity and household production could be achieved as Blackden and Bhanu suggest [16]. For this, women's role both productive and reproductive roles within the household should be recognized, against the assumption that women's time is endlessly flexible. This again is important in overall productivity. For example, as regards female headed households, although collective action such as women's farmer groups for collective ownership for land, could be a solution, because of heavy time and work burdens, women may find these activities time-consuming, lowering their incentives to participate [17].

Thus, it would be unrealist to suggest that male politicians or agents could completely understand female specific needs. "*Above all, women must participate in drawing up development plans so that they reflect female realities and provide appropriate services*"([18], p.15). For this, "*female participation in state affairs, especially high-level planning and policy decision-making is necessary*" ([18], p.15), in order for women to be able to capture meaningful benefits which would result in their empowerment. As regards, structural adjustment, not only could not overcome poverty, but as well could not overcome gender inequality. In this perspective, recognizing gender equality is important and must be based upon equal distribution of resources in between centre and the periphery and in between genders within a social justice approach to democracy. Thus, as applies to ESAPs, sustainable development is a strategy beyond quantifiable indicators and must take into consideration the social, political and economic contexts.

## 6. RESULTS AND DISCUSSION

As a result, an anti-colonial approach to sustainable development within the framework of structural adjustment and women in agriculture must discuss the following remarks:

- After independence, although African economies first followed a state-driven economic policy, with the intrusion of IFIs through economic structural adjustment programs (ESAPs), North-South power relations have once again been reestablished.
- The colonial division of labor is still present in North-South/centre-periphery power relations on the level of international relations.
- Based on quantitative data and far from internal economic realities, ESAPs which exclude local authorities and impose external conditionalities, are the continuation of the colonial division of labor.
- This colonial division of labor has been monitored through the involvement of the African elite class that has again been promoted by the once colonizing powers.
- The participation of the African elite class in the exploitation of the resources of the continent is against the effective use of the resources and thus against sustainable development.
- Sustainable development is about equal distribution of resources in between centre and periphery, rich and poor and in between genders.
- As regards, within colonial division of labor as opposed to sustainable development, the problematic of democracy results from the social justice perspective apported to democracy as the foremost subject matter, on all the global, national and local and household levels.
- On the other hand, ESAPs based the neo-liberal ideology, thus export oriented strategies foresaw the exportation of primary products, preventing African industrialization and a home grown African economy to develop against the assumptions of sustainable development.
- As applied to agriculture, ESAPs foresaw the exportation of a few varieties of cash crops against biodiversity and sustainable development.
- Overall, ESAPs had negative consequences for the poor peasants in the rural, subject to market signals of the capitalist model and deprived from the once state provided social services.
- Among those, poor women were the ones who most suffered from ESAPs because while men assumed cash crops, women were to assume food crops without monetary value in the market while at the same time providing for those services.
- This gender division of labor as part of the colonial heritage is again the reflection of unegalitarian power relations.
- As regards, in ancient Africa, women had an important socio-political status because of their reproductive roles but with the colonial powers they saw their status decline.
- Within this framework, women's reproductive roles such as birth giving, health care and education must be recognized not only for sustaining economy, but as well for sustaining society and sustainable development.
- The relationship between the productive/market and reproductive/domestic economy must also be recognized especially when state no more provides for those services under economic structural adjustment.
- Women's empowerment is central to sustainable development, especially as concerns rural women in the agriculture.

## 7. CONCLUSIONS

It may be asserted that sustainable development covers wide ranging aspects as explored in this paper. Apart from the points mentioned above, the significance of this paper results from the multi-dimensional and inter-disciplinary approach adopted when exploring the subject-matter. Within this inter-disciplinary approach, an anti-colonial approach to sustainable development within the framework of structural adjustment and women in agriculture must recognize principally the following analytical tools of reflection:

Import substitution industrialization versus export oriented strategies of primary goods, North-South/centre-periphery power relations versus colonial division of labor under ESAPs, colonial division of labor versus gender division of labor, cash/male crops versus food/female crops, women's reproductive roles versus productive roles and lastly market economy versus domestic economy. All those analytical tools of reflection are in relation with sustainable development from the view point of distribution of resources.

As regards distribution of resources, an anti-colonial approach to sustainable development needs especially not to ignore the implications of the historical process under colonialism in centre-periphery and North-South relations with its implications also throughout the 20<sup>th</sup> and the 21<sup>st</sup> histories. Economic structural adjustment programs (ESAPs) within the IFIs have therefore only intensified this colonial division of labor. Such a division of labor translates as well into the relationships in between genders, men and women, as the colonial administration was to discriminate against women. Therefore, as applied to agriculture, within the implications of structural adjustment, poor people in relation to the rich and women as regards men have been the least beneficiary, which shows the overall lack of social justice within the problematic of democracy both in North-South/centre-periphery and men-women relationships. An anti-colonial approach to sustainable development should therefore study the democracy factor as well from the aspect of social justice on all the global, national, local and household levels while not ignoring the implications of socio-economic processes throughout the history.

## REFERENCES

- [1]. L. Taylor and H. Shapiro, "The State and Industrial Strategy", *World Development*, Vol.18, No.6, pp.861-878, 1990.
- [2]. F. Heidhues and G. Obare, "Lessons from Structural Adjustment Programmes and their Effects in Africa", *Quarterly Journal of International Agriculture*, Vol. 50, No.1, pp.55-64, 2011.
- [3]. Y. Bangura, "Authoritarian Rule and Democracy in Africa, A Theoretical Discourse", *Authoritarianism Democracy and Adjustment, The Policies of Economic Reform in Africa*, 2<sup>nd</sup> ed., P. Gibbon, Y. Bangura & A. M. Ofstad (eds.), Sweden: Bohuslaningens Boktryckeri AB, pp. 39-82, 1993.

- [4]. P. Bond, *Looting Africa, the Economics of Exploitation*, 1<sup>st</sup> ed., London and Pietermaritzburg: Zed Books and University of Kwazulu Natal Press, 2006.
- [5]. World Bank, *Africa's Adjustment and Growth in the 1980s*, Washington, 1989.
- [6]. B. Beckman, "Empowerment or Repression? The World Bank and the Politics of African Adjustment", *Authoritarianism Democracy and Adjustment, The Policies of Economic Reform in Africa*, 2<sup>nd</sup> ed., P. Gibbon, Y. Bangura & A. M. Ofstad (eds.), Sweden: Bohuslaningens Boktryckeri AB, pp.83-105, 1993.
- [7]. Y. Bangura and P. Gibbon, "Adjustment, Authoritarianism and Democracy in Sub-Saharan Africa, An Introduction to Some Conceptual and Empirical Issues", *Authoritarianism Democracy and Adjustment, The Policies of Economic Reform in Africa*, 2<sup>nd</sup> ed., P. Gibbon, Y. Bangura & A. M. Ofstad (eds.), Sweden: Bohuslaningens Boktryckeri AB, pp.7-38, 1993.
- [8]. H. Stein, *Economic Development and the Anatomy of Crises in Africa: From Colonialism through Structural Adjustment*, Centre of African Studies, University of Copenhagen, May 2000 [Online]. Available: <http://www.rrojasdatabank.info/devstate/Stein.pdf>
- [9]. S. M. Kawewe and R. Dible, "The Impact of Economic Structural Adjustment Programs (ESAPs) on Women and Children: Implications of Social Welfare in Zimbabwe", *The Journal of Sociology and Social Welfare*, Vol.27, Issue 4, pp.79-108, December 2000.
- [10]. J. Toye, "Interest Group Politics and the Implementation of Adjustment Policies in Sub-Saharan Africa", *Authoritarianism Democracy and Adjustment, The Policies of Economic Reform in Africa*, 2<sup>nd</sup> ed., P. Gibbon, Y. Bangura & A. M. Ofstad (eds.), Sweden: Bohuslaningens Boktryckeri AB, pp.106-126, 1993.
- [11]. W. E. Segueda, *Imported Religions, Colonialism and the Situation of Women in Africa*, Young Africa Centre Series, 03/2015.
- [12]. P. M. Martin and P. O'Meara, *Africa*, 3<sup>rd</sup> ed., Bloomington: Indiana University Press, 1995.
- [13]. A. J. Njoh, *Tradition, Culture and Development in Africa, Historical Lessons for Modern Development Planning*, 1<sup>st</sup> ed., Aldershot: Ashgate Publishing Company, 2006.
- [14]. G. Mikell, "African Structural Adjustment: Women and Legal Challenges", *St. John's Law Review*, Vol.69, No. 1-2, pp.7-26, Winter-Spring 1995.
- [15]. FAO (2007), *Women Farmer's Productivity in Sub-Saharan Africa*, [Online]. Available: [http://www.unep.org/training/programmes/Instructor%20Version/Part\\_2/Activities/Human\\_Societies/Agriculture/Supplemental/Women-Farmers\\_Productivity\\_in\\_Sub\\_Saharan\\_Africa.pdf](http://www.unep.org/training/programmes/Instructor%20Version/Part_2/Activities/Human_Societies/Agriculture/Supplemental/Women-Farmers_Productivity_in_Sub_Saharan_Africa.pdf)
- [16]. M. Blackden and C. Bhanu, "Gender, Growth & Poverty Reduction: Special Programme for Assistance of Africa", 1998 Status Report in Poverty in Sub-Saharan Africa, World Bank, Washington, 1999.
- [17]. K. Weinberger and J. Jütting, "Women's Participation in Local Organizations: Conditions and Constraints", *World Development*, Vol. 29, No.8, pp.1391-1404, 2001.
- [18]. J. L. Parpart, *Women and State in Africa*, Working Paper 117, May 1986, [Online]. Available: [http://pdf.usaid.gov/pdf\\_docs/PNAX586.pdf](http://pdf.usaid.gov/pdf_docs/PNAX586.pdf)

## BIOGRAPHY

Aslı Ege is currently teaching political science and international relations at the French Speaking Department of Public Administration of Marmara University in Istanbul/Turkey. Her fields of interest are generally Turkey's European identity, women and development and multi-culturalism. She has been to various conferences and published articles on those topics.

# Some Physical Properties of Cemre (*Triticum aestivum* L.) and Saricanak-98 (*Triticum durum* Desf.) Wheat Seeds

Cevdet Saglam<sup>1</sup>, Necati Cetin<sup>2</sup>

---

## Abstract

*In this study, some physical properties of Cemre and Saricanak-98 wheat species produced in GAP (The Southeastern Anatolia Project) region were determined. These varieties are quite well in terms of yield, quality and nutritional value. Following the harvest, physico-mechanical properties of seeds are required in order to be processed easily and cost-effectively.*

*Some physical properties of Cemre and Saricanak-98 wheat seeds were determined as a function of moisture content in the range of 10,85 – 19,2% and 10,16 – 19,74% dry basis (d.b.) respectively. The average length, width and thickness were 6,85 mm, 3,11 mm ve 2,75 mm for Cemre wheat seeds at a moisture content of 10,85% d.b. and 7,52 mm, 3,37 mm ve 2,97 mm for Saricanak-98 wheat seeds at a moisture content of 10,16% d.b., respectively. Moisture in the Cemre and Saricanak-98 seeds in range from 10,85 – 19,2 ve 10,16 – 19,74 d.b. respectively, studies on rewetted seeds showed that for thousand seed mass increased from 35,38 to 47,89 g for Cemre and from 49,87 to 64,49 g for Saricanak-98, the projected area increased from 20,39 to 25,36 mm<sup>2</sup> for Cemre and from 24,87 to 28,87 mm<sup>2</sup> for Saricanak-98. In addition, sphericity, porosity, terminal velocity, bulk density and true density varies in properties were determined. The static coefficient of friction of wheat seeds increasing moisture content in dry basis aluminum, stainless steel and galvanized iron have been identified to be 3 different surface for Cemre and Saricanak-98 seeds.*

**Keywords:** *Wheat, seed, physical properties, moisture content*

---

## 1. INTRODUCTION

Wheat belongs to Triticeae tribe of Poaceae family. Together with rye and barley, it is the most widely produced cereal crop worldwide. These species are major annual crops of temperate regions. The centre of origin of the species is so called as 'fertile crescent' in the middle east from where they have travelled to all continents of the world. Wheat kernel size is important parameter in terms of yield and quality. Several researches and breeding programs have been conducted to improve kernel sizes. Visually appealing and high market value kernels must be larger and uniform. Thousand seed weight (TSW) is another parameter indicating yield characteristics and it is commonly used in wheat classification. TSW can easily be measured and used to estimate agronomical output of a wheat genotype [1]. Length and width of the kernel have been tested as non-invasive and cheap determinants of the grinding quality of bread wheat genotypes [2].

Reference [3] shows evaluated various physical properties of lentil seeds namely bulk density, porosity, projected area, terminal velocity and coefficient of static and dynamic friction. In another study conducted by reference [4] shows, engineering properties of some seeds such as density, terminal velocity and coefficient of drag were reported.

As a function of moisture content, there are various physical properties should be taken into account in the design of some equipment used for several purposes such as plantation, harvest and post harvest (transportation, storage and processing of dried) applications. It is necessary to know the physical properties of wheat seeds to design and improve of relevant machines and facilities for harvesting, storing, packing and processing. In the design of machines used for separating, harvesting, sizing and milling, there is a need to know various parameters of wheat seed like size, shape and mechanical behaviour. The structural loads are influenced by bulk density and porosity while the angle of repose is significant in designing storage and transporting structures. The coefficient of friction of the seed related to the surface is also an important parameter in designing conveying, transporting and storing structures. [5],[6]-[7]

In recent years, physical properties have been studied by many researchers for various crops such as faba bean grain [5],[8]; radish seed [9]; sugarbeet seed [10]; orange [11]; walnut [12],[13],[14]; edible squash seed [15]; chickpea seed [16],[17]; soybean grain [18]; cumin seed [19]; hemp seed [20]; lentil seed [21]; yarma bulgur [22]; pine nuts [23]; vetch seed [24] and gilaburu seed [25]. Objective of this study was to determine some moisture-dependent physical properties of two different

---

<sup>1</sup>Corresponding author: Assoc. Prof. Erciyes University, Faculty of Agriculture, Department of Biosystems Engineering, 38039, Melikgazi/Kayseri, Turkey. [cevdetsaglam@erciyes.edu.tr](mailto:cevdetsaglam@erciyes.edu.tr)

<sup>2</sup>Res. Ass. Erciyes University, Faculty of Agriculture, Department of Biosystems Engineering, 38039, Melikgazi/Kayseri, Turkey. [necat CETIN@erciyes.edu.tr](mailto:necat CETIN@erciyes.edu.tr)

wheat species namely size, dimensions, thousand seed mass, projected area, sphericity, bulk density, true density, porosity, terminal velocity and static coefficient of friction against three structural surfaces.

## 2. MATERIALS AND METHODS

Wheat seeds of the species that make up the material of the study were obtained from the GAP International Agricultural Research Center, Diyarbakır, Turkey. Samples having the desired moisture contents (13.68 and 19.14 %) were prepared by adding a certain amount of distilled water. The initial moisture content was determined by oven drying at  $105 \pm 1$  °C for 24 h [26],[27]. Initial moisture content of the wheat seeds was 10.85% d.b. for Cemre and 10.16% d.b. for Saricanak-98.

The moisture contents were calculated from the following equation [20].

$$Q = \frac{W_i(M_f - M_i)}{(100 - M_f)} \quad (1)$$

Where  $Q$  is the amount of water added (kg),  $W_i$  is the initial weight of the sample (kg),  $M_i$  is the initial moisture content of the sample (% dry basis) and  $M_f$  is the final moisture content of the sample (% dry basis).

Representative materials were stored for 7 days in a refrigerator at 5 °C temperature to achieve a uniform distribution of moisture. Before starting the tests, the samples were taken in desired proportions from the refrigerator and allowed to warm to room temperature [28],[29].

Physico-mechanical properties of Cemre and Saricanak-98 seeds were determined at 10.85 to 19.2 % and 10.16 to 19.74% moisture content d.b.(dry basis) respectively. Each test was repeated 10 times for each humidity level. The weight, length, width and thickness values of the seed samples, were determined randomly from the 100 seeds within. The length  $L$ , width  $W$  and thickness  $T$  of materials were measured using a micrometer with an accuracy of 0.01 mm.

The sphericity of wheat seeds  $\phi$  was calculated by using the equation [30]:

$$\phi = \frac{(LWT)^{1/3}}{L} \quad (2)$$

The thousand seed weight was determined by an electronic balance ( $\pm 0.001$  g). The projected area of a seed was measured by a scanner connected to a computer. For this purpose, a special computer program was used [27]. The average bulk density of the wheat seed was determined using the standard test weight procedure as described by [19], by filling a container of 500 ml with the seed from a height of 150 mm at a constant rate and then weighing the content. The average true density was determined using the toluene displacement method. The volume of toluene displaced was found by immersing a weighed quantity of wheat seed into the toluene [19],[29],[24].

The porosity was calculated from the following equation [30]:

$$P_f = (1 - \rho_b / \rho_t) \times 100 \quad (3)$$

Where  $P_f$  is the porosity in %;  $\rho_b$  is the bulk density in kg m<sup>-3</sup>; and  $\rho_t$  is the true density in kg m<sup>-3</sup>.

At different moisture contents, the terminal velocity of seeds was determined using cylindrical air column. For each experiment, a sample was dropped into the air stream from the top of the air column, up which air was blown to suspend the material in the air stream. The air velocity near the location of the seed suspension was measured by a hot wire anemometer having a least count of 0.01 m s<sup>-1</sup>. The cylinder is raised up lightly as far as not to touch the surface. The structural surface with the cylinder resting on it was raised gradually with a screw device until the cylinder just started to slide down and the angle of tilt,  $\alpha$ , was read from a graduated scale [19],[26],[31].

The coefficient of friction was calculated from the following equation:

$$\mu = \tan \alpha \quad (4)$$

Where  $\mu$  is the coefficient of friction; and  $\alpha$  is the angle of tilt in degrees.

## 3. RESULTS AND DISCUSSION

**Seed dimensions:** The average dimensions measured at 100 seeds at moisture content of 10.85% d.b. for Cemre and 10.16% d.b. for Saricanak-98 were as follows: length = 6.85, width = 3.11 and thickness = 2.75 mm for Cemre and length = 7.52 mm, width = 3.37 mm and thickness = 2.97 mm for Saricanak-98. Size frequencies exhibited a normal distribution in both species.

**Thousand seed mass:** The thousand seed mass  $m_{1000}$  increased linearly for Cemre from 35.89 to 47.89 g and for Saricanak-98 from 49.87 to 64.49 as the moisture content increased respectively from 10.85 to 19.2% d.b. and from 10.16 to 19.74% (Fig. 1). The thousand seed mass can be formulated with the following linear equations:

$$m_{1000} = 21.316 + 1.4096M_c \quad (R^2 = 0.9762) \quad (5)$$

$$m_{1000} = 35.583 + 1.4995M_c \quad (R^2 = 0.9748) \quad (6)$$

Reference [20] for hemp seed, reference [19] for white lupin and reference [29] for cumin reported linear increase in the thousand seed mass with increasing moisture contents.

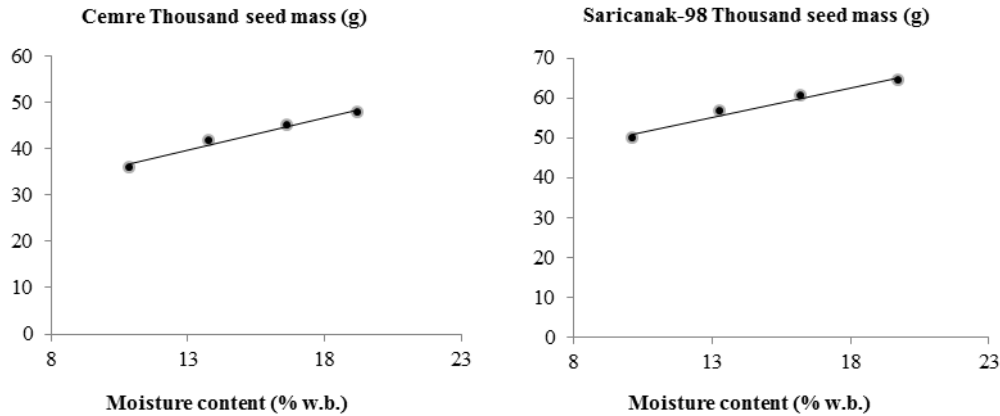

Figure 1. Effects of moisture content on thousand seed mass

**Projected area of seed:** The projected area of wheat seeds increased for Cemre from 20,39 to 25,36 mm<sup>2</sup> and for Saricanak-98 from 24.87 to 28.87 mm<sup>2</sup>, when the moisture content of seed increased respectively from 10.85 to 19,2% d.b. and from 10.16 to 19.74% d.b. (Fig. 2). The projected area of wheat seed can be represented by the following equation:

$$A_p = 13.472 + 0.6153M_c \quad (R^2 = 0.9828) \quad (7)$$

$$A_p = 20.628 + 0.4208M_c \quad (R^2 = 0.9986) \quad (8)$$

Similar trends were reported by [32], [3] for lentil, [27] for cotton and [17] for chick pea seeds.

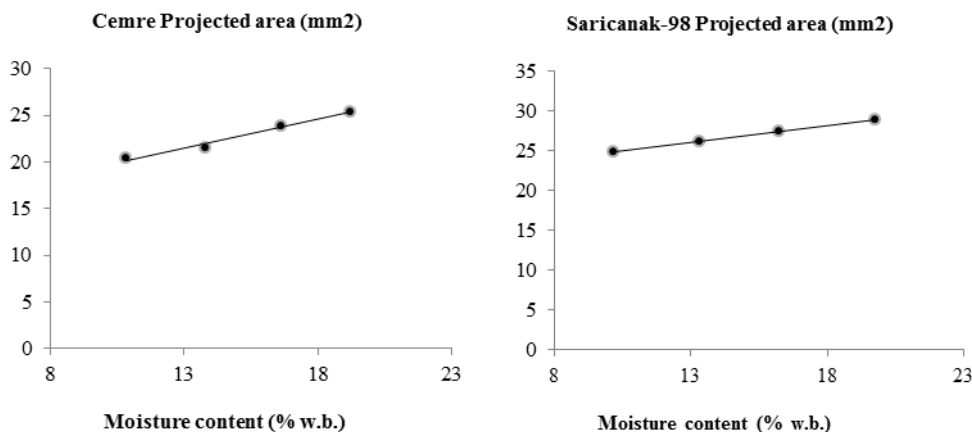

Figure 2. Effects of moisture content on projected area

**Sphericity:** The sphericity of wheat seeds decreased for Cemre from 0.567 to 0.561 and increased for Saricanak-98 from 0.562 to 0.567 with the increase in moisture content (Fig. 3). The relationship between sphericity and moisture content  $M_c$  in 10.85-19.2% d.b. and 10.16-19.74% d.b. can be represented by the following equations:

$$\varphi = 6E - 05M_c^3 - 0.0024M_c^2 + 0.0315M_c + 0.4378 \quad (R^2 = 1) \quad (9)$$

$$\varphi = 7E - 05M_c^3 - 0.0030M_c^2 + 0.0418M_c + 0.3717 \quad (R^2 = 1) \quad (10)$$

Similar trends were also reported by [33] for Turkish mahaleb and [34] for okra seeds.

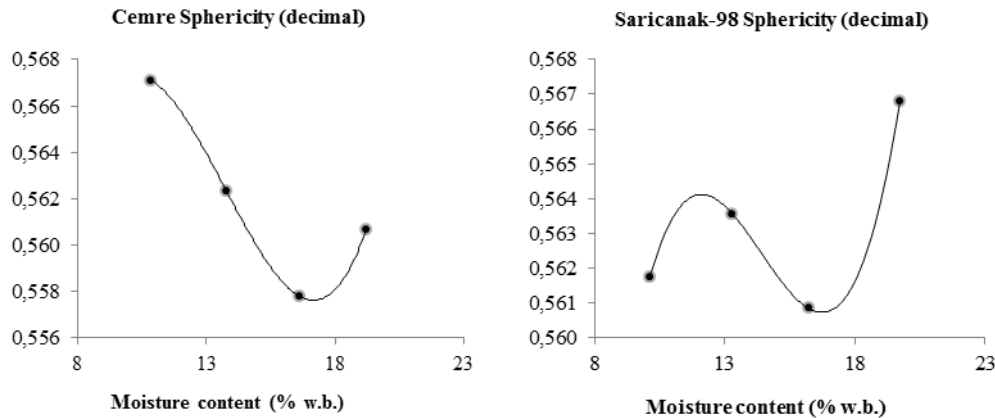

Figure 3. Effects of moisture content on sphericity

**Bulk density:** The values of the bulk density decreased for Cemre from 769.25 to 653.8 kg m<sup>-3</sup> and for Saricanak-98 from 796.15 to 716.25 kg m<sup>-3</sup> (Fig. 4). The bulk density of seed was found to bear the following relationship with moisture content:

$$\rho_b = 920.09 - 13.703M_c \quad (R^2 = 0.9957) \quad (11)$$

$$\rho_b = 885.83 - 8.5404M_c \quad (R^2 = 0.9909) \quad (12)$$

A similar decreasing trend in bulk density was reported by [34] for okra, by [17] for chick pea and by [35] for sunflower seeds.

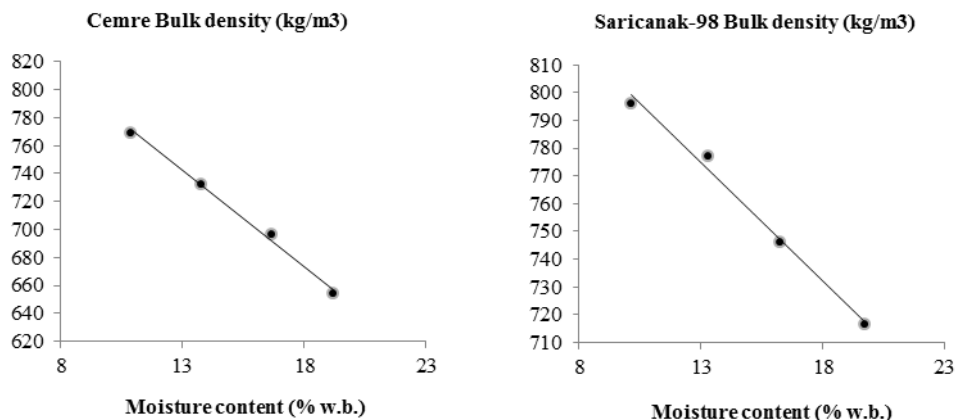

Figure 4. Effects of moisture content on bulk density

**True density:** The true density decreased for Cemre from 1248,44 to 1128,67 kg m<sup>-3</sup> and for Saricanak-98 from 1265,82 to 1176,47 when the moisture level increased respectively from 10.85 to 19.2% d.b. and from 10.16 to 19.74% d.b. (Fig. 5). The true density and the moisture content of seed can be correlated as follows:



$$\rho_t = 1410.6 - 14.536M_c \quad (13)$$

$$(R^2 = 0.9918)$$

$$\rho_t = 1368.2 - 9.5373M_c \quad (R^2 = 0.9793)$$

$$(14)$$

The results were similar to those reported by [27] for cotton and [36] for amaranth seeds.

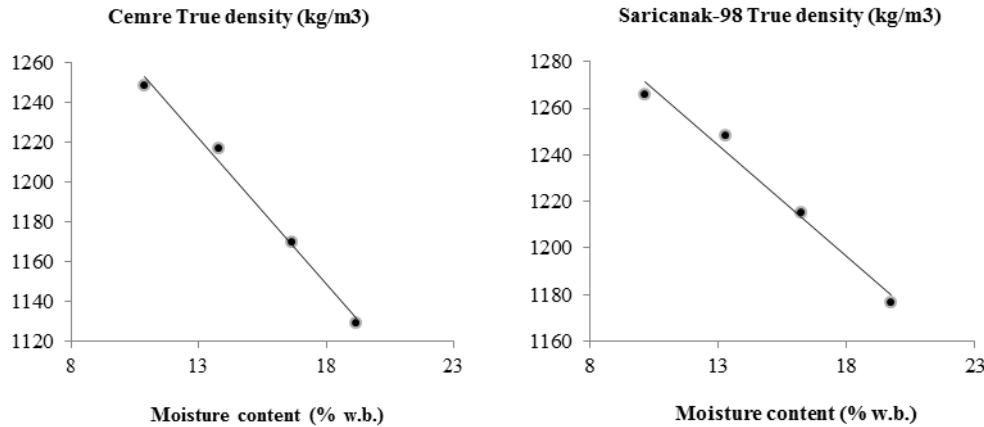

Figure 5. Effects of moisture content on true density

**Porosity:** The porosity of wheat seeds increased for Cemre from 38.38 to 42.07% and for Saricanak-98 from 37.10 to 39.12% with the increase in moisture content respectively from 10.85 to 19.2% d.b. and 10.16 to 19.74% d.b. (Fig. 6). The relationship between porosity and moisture content can be represented by the following equations:

$$P_f = 33.816 + 0.4213M_c \quad (R^2 = 0.9772) \quad (15)$$

$$P_f = 34.933 + 0.2160M_c \quad (R^2 = 0.9876) \quad (16)$$

Reference [19],[35],[29]-[24] reported similar trends for porosity of cumin, sunflower, white lupin and vetch seeds, respectively.

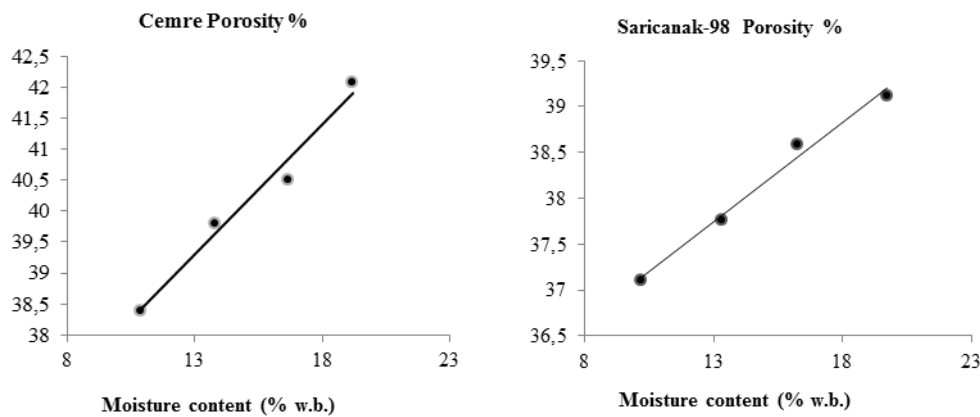

Figure 6. Effect of moisture content on porosity

**Terminal velocity:** The experimental results for the terminal velocity of wheat seed at various moisture levels are presented in Fig. 7. The terminal velocity increased linearly for Cemre from 7.64 to 7.83 m s<sup>-1</sup> and for Saricanak-98 from 8.07 to 8.22 as the moisture content increased respectively from 10.85 to 19.2% d.b. and from 10.16 to 19.74% d.b. The relationship between terminal velocity and moisture content can be represented by the following equations:

$$V_t = 0.0026M_c^3 - 0.1271M_c^2 + 2.0306M_c - 2.7635 \quad (R^2=1)$$

$$(17) V_t = 0.0045M_c^3 - 0.2106M_c^2 + 3.2106M_c - 7.4986 \quad (R^2=1)$$

$$(18)$$

Similar results were reported by [35],[26]-[37] for terminal velocity of sunflower, karingda and pumpkin seeds, respectively.

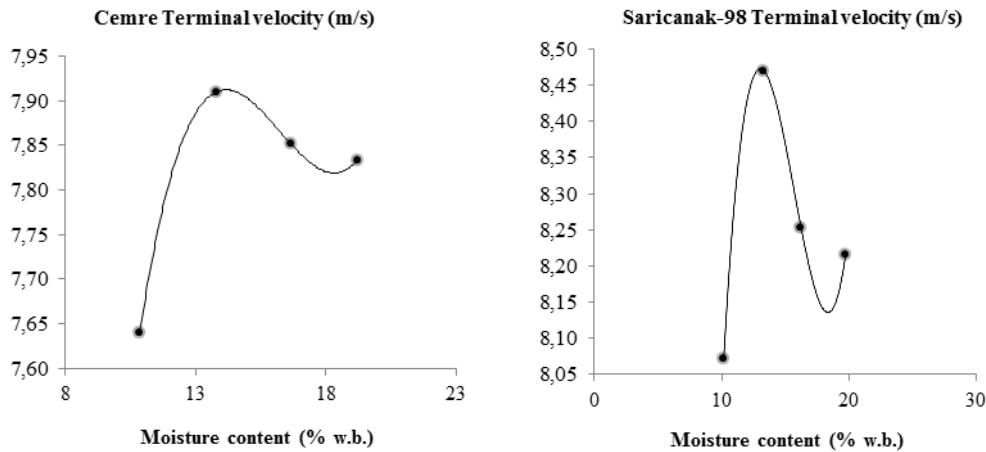

Figure 7. Effects of moisture content on terminal velocity

**Static coefficient of friction:** The static coefficient of friction for wheat seeds on three surfaces (aluminium, stainless steel and galvanized iron) against moisture content in the range from 10.85 to 19.2% d.b. for Cemre and from 10.16 to 19.74% d.b. for Saricanak-98 are shown in Fig. 8.

Static coefficient of friction increased with increasing moisture contents. The values for Cemre and Saricanak-98 were determined at three surfaces as follows: 0.289-0.403 for aluminium, 0.279-0.398 for stainless steel and 0.279-0.398 for galvanized iron for Cemre; 0.293-0.428 for aluminium, 0.290-0.400 for stainless steel and 0.295-0.444 for galvanized iron for Saricanak-98). At higher moisture values, the adhesion between the seed and the material surfaces increased. Such increases were recorded as 16.58, 15.98 and 16.70% for Cemre and 16.76, 16.60 and 16.92% for Saricanak-98 for aluminium, stainless steel and galvanized iron, respectively as the moisture content increased from 10.85 to 19.2% d.b. for Cemre and from 10.16 to 19.74% d.b. for Saricanak-98. The least static coefficient of friction was observed on stainless steel. This may be due to smoother and more polished surface of the stainless steel sheet than the other materials. The relationships between static coefficients of friction and moisture content on aluminium  $\mu_{al}$ , stainless steel  $\mu_{ss}$  and galvanized iron  $\mu_{gi}$ , can be represented by the following equations:

$$\mu_{al} = 0.1545 + 0.0129M_c \quad (R^2 = 0.997) \quad (19)$$

$$\mu_{ss} = 0.1390 + 0.0135M_c \quad (R^2 = 0.9665) \quad (20)$$

$$\mu_{gi} = 0.1193 + 0.0161M_c \quad (R^2 = 0.97) \quad (21)$$

$$\mu_{al} = 0.1525 + 0.0137M_c \quad (R^2 = 0.9817) \quad (22)$$

$$\mu_{ss} = 0.1787 + 0.0113M_c \quad (R^2 = 0.9913) \quad (23)$$

$$\mu_{gi} = 0.1509 + 0.0151M_c \quad (R^2 = 0.9775) \quad (24)$$

Similar results were found by [34],[27],[3]-[38] for okra, cotton, lentil and pigeon pea seeds, respectively.

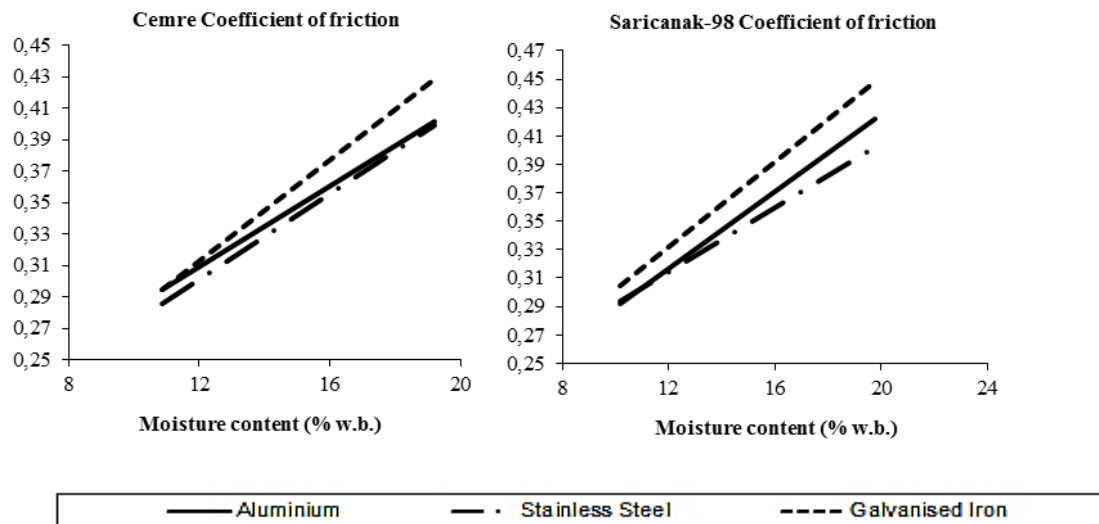

Figure 8. Effects of moisture content on static coefficient of friction

## 4. CONCLUSIONS

Some physical properties of Cemre and Saricanak-98 wheat seeds were determined as a function of moisture content in the range of 10.85 – 19.2% and 10.16 – 19.74% dry basis, respectively. Average length, width and thickness of wheat seeds increased with increasing moisture contents.

The thousand seed mass increased linearly for Cemre and Saricanak-98 from 35.89 to 47.89 g and from 49.87 to 64.49, the projected area increased linearly from 20.39 to 25.36 mm<sup>2</sup> and from 24.87 to 28.87 mm<sup>2</sup>, respectively. The sphericity decreased nonlinearly for Cemre from 0.567 to 0.561 and increased nonlinearly for Saricanak-98 from 0.562 to 0.567.

The bulk density decreased linearly for Cemre from 769.25 to 653.8 kg m<sup>-3</sup> and for Saricanak-98 from 796.15 to 716.25 kg m<sup>-3</sup> and the true density decreased linearly for Cemre from 1248.44 to 1128.67 kg m<sup>-3</sup> and for Saricanak-98 from 1265.82 to 1176.47 kg m<sup>-3</sup>. The porosity increased for Cemre and Saricanak-98 from 38.38 to 42.07% and from 37.10 to 39.12%, the terminal velocity increased from 7.64 to 7.83 m s<sup>-1</sup> and from 8.07 to 8.22 m s<sup>-1</sup> respectively.

The static coefficient of friction increased for all three surfaces, namely, for Cemre aluminium (0.289-0.403), stainless steel (0.279-0.398) and galvanized iron (0.291-0.426) and for Saricanak-98 aluminium (0.293-0.428), stainless steel (0.290-0.400) and galvanized iron (0.295-0.444). The galvanized iron as a surface for sliding offered the maximum friction followed by aluminium and stainless steel.

## REFERENCES

- [1] Baril CP, 1992. Factor regression for interpreting genotype- environment interaction in bread-wheat trials. *Theor Appl Genet* 83: 1022–1026.
- [2] Berman M, Bason ML, Ellison R, Peden G, Wrigley CW, 1996. Image analysis of the whole grains to screen for flour-milling yield in wheat breeding. *Cereal Chem* 73: 323–327.
- [3] Carman, K. (1996). Some physical properties of lentil seeds. *Journal of Agricultural Engineering Research*, 63, 87–92.
- [4] Kural, H., & Carman, K. (1997). Aerodynamic properties of seed crops. National symposium on mechanisation in agriculture, Tokat, Turkey (pp. 615–623).
- [5] Altuntaş, Ebubekir, and Mehmet Yıldız. "Effect of moisture content on some physical and mechanical properties of faba bean (*Vicia faba* L.) grains." *Journal of Food Engineering* 78.1 (2007): 174-183.
- [6] Amer Eissa, Ayman Hafiz, Mohamed MA, and Abdul Rahman O. Alghannam. "Moisture dependent physical and mechanical properties of chickpea seeds." *International Journal of Agricultural and Biological Engineering* 3.4 (2010): 80-93.
- [7] Tavakoli, Hamed, Ali Rajabipour, and Seyed Saeid Mohtasebi. "Moisture-dependent some engineering properties of soybean grains." *Agricultural Engineering International: CIGR Journal* (2009).
- [8] Dilmac, Mesut, Sefa Tarhan, and Hakan Polatci. "Aerodynamic properties of Faba bean (*Vicia faba* L.) Seeds." *Legume Research-An International Journal* 39.3 (2016).
- [9] Çetin M., Şimşek E., Akbaş T., Özarslan C. 2010. Physical properties of radish (*Raphanus sativus* L.) seed as a function of moisture content. *The Philippine Agricultural Scientist*, 93 (3): 291–298
- [10] Kasap A., Altuntas E. "Physical properties of monogerm sugarbeet (*Beta vulgaris* var. altissima) seeds." *New Zealand journal of crop and horticultural science* 34.4 (2006): 311-318.
- [11] Sayinci, B., Ercisli, S., Ozturk, I., Eryilmaz, Z., and Demir, B. (2012). Determination of Size and Shape in the Moro'Blood Orange and Valencia'Sweet Orange Cultivar and its Mutants Using Image Processing. *Notulae Botanicae Horti Agrobotanici Cluj-Napoca*, 40(1), 234.
- [12] Ercisli, S., Mazhar, K. A. R. A., Ozturk, I., Sayinci, B., & Kalkan, F. (2011). Comparison of some physico-mechanical nut and kernel properties of two walnut (*Juglans regia* L.) cultivars. *Notulae Botanicae Horti Agrobotanici Cluj-Napoca*, 39(2), 227.
- [13] Ercisli, S., Sayinci, B., Kara, M., Yildiz, C., & Ozturk, I. (2012). Determination of size and shape features of walnut (*Juglans regia* L.) cultivars using image processing. *Scientia horticultrae*, 133, 47-55.

- [14] Altuntas, Ebubekir, and Yakup Özkan. "Physical and mechanical properties of some walnut (*Juglans regia* L.) cultivars." *International journal of food engineering* 4.4 (2008).
- [15] Paksoy, M., and C. Aydin. "Some physical properties of edible squash (*Cucurbita pepo* L.) seeds." *Journal of Food Engineering* 65.2 (2004): 225-231.
- [16] Amer Eissa, Ayman Hafiz, Mohamed MA, and Abdul Rahman O. Alghannam. "Moisture dependent physical and mechanical properties of chickpea seeds." *International Journal of Agricultural and Biological Engineering* 3.4 (2010): 80-93.
- [17] Konak, M. "Carman K., and Aydin. C.(2002). Physical properties of chickpea seeds." *Biosys Eng* 82.1: 73-78.
- [18] Tavakoli, Hamed, Ali Rajabipour, and Seyed Saeid Mohtasebi. "Moisture-dependent some engineering properties of soybean grains." *Agricultural Engineering International: CIGR Journal* (2009).
- [19] Singh, K. K., and T. K. Goswami. "Physical properties of cumin seed." *Journal of Agricultural Engineering Research* 64.2 (1996): 93-98.
- [20] Sacilik, K., R. Öztürk, and R. Keskin. "Some physical properties of hemp seed." *Biosystems Engineering* 86.2 (2003): 191-198.
- [21] Carman, K. "Some physical properties of lentil seeds." *Journal of Agricultural Engineering Research* 63.2 (1996): 87-92.
- [22] Ozgoz, Engin, O. Farak Taser, and Ebubekir Altuntas. "Some Physical Properties of Yarma Bulgur." *Journal of Applied Sciences* 5.5 (2005): 838-840.
- [23] Ozguven, Faruk, and Kubilay Vursavus. "Some physical, mechanical and aerodynamic properties of pine (*Pinus pinea*) nuts." *Journal of Food Engineering* 68.2 (2005): 191-196.
- [24] Yalcin, I., and Ozarslan, C. (2004). Physical properties of vetch seed. *Biosystems Engineering*, 88(4), 507–512.
- [25] Sonmez, N., Alizadeh H.H.A., Ozturk, R., and Acar A.I., "Some physical properties of Gilaburu seed." *Tarim Bilimleri Dergisi* 13.3 (2007): 308-311.
- [26] Suthar S.H., Das S.K. 1996. Some physical properties of karingda *Citrullus lanatus* (Thumb.) Mansf.] seeds. *J Agric Eng Res* 65: 15-22.
- [27] Ozarslan C. 2002. Physical properties of cotton seed. *Biosys Eng* 83: 169-174.
- [28] Desphande, S.D., Bal, S., Ojha, T.P. 1993. Physical properties of soybean seeds. *Journal of Agriculture Engineering Research*. 56: 89-92.
- [29] Ögüt, H. 1998. Some physical properties of white lupin. *Journal of Agricultural Engineering Research*, 56: 273-277
- [30] Mohsenin N.N. 1986. *Physical Properties of Plant and Animal Materials*. New York: Gordon and Breach Science Publishers. 882 p.
- [31] Dutta S.K, Nema VK, Bhardwaj R.K., 1988. Physical properties of gram. *J Agric Eng Res* 39: 259-268.
- [32] Tang J, Sokhansanj S. 1993. Geometric changes in lentil seeds caused by drying. *J Agric Eng Res* 56: 313-326.
- [33] C. Aydin, H. Ögüt, M. Konak (2002). Some physical properties of Turkish Mahaleb *Biosystems Engineering*, 82 (2) , pp. 231–234
- [34] Sahoo P.K., Srivastava A.P. 2002. physical properties of okra seed. *Biosystems Engineering* 83(4): 441–448
- [35] Gupta R.K., Das S.K., 1997. Physical properties of sunflower seeds. *J Agric Eng Res* 66: 1-8.
- [36] Abalone R, Cassinera A., Gaston A., Lara M.A., 2004. Some physical properties of amaranth seeds. *Biosys Eng* 89: 109-117.
- [37] Joshi D.C, Das S.K., Mükherjee R.K. 1993. Physical properties of pumpkin seeds. *J Agric Eng Res* 54: 219-229.
- [38] Shepherd H., Bhardwaj R.K., 1986. Moisture-dependent physical properties of pigeon pea. *J Agric Eng Res* 35: 227-234.

# *Sorghum in Phytoremediation*

*Ridvan Temizgul<sup>1</sup>, Mahmut Kaplan<sup>2</sup>, Semih Yilmaz<sup>3</sup>*

---

## **Abstract**

Environmental pollution due to human activities in industrial and mining areas started to be a big global problem. Heavy metals, pesticides, organic and radioactive wastes are among the leading polluters and occupy an important place. Because of the complexity of relations among parameters and differences of pollutants, it becomes difficult to clean these areas by physical and chemical methods.

Phytoremediation is an environmentally friendly and low cost biotechnological method using plants for immobilization and degradation of contaminants in polluted areas. Choose of ideal plant species and appropriate enhancing criteria are the most important requirements for obtaining high efficiency remediation and beneficial biomass.

The popularity of sorghum is increasing every day due to its widespread use in bioethanol production and animal feed as well as its adaptability to dry and salty areas, compatibility to low input agricultural fields, availability as basic food for more than 500,000 people, and use as supplementary product for treatment of various diseases. In addition, sorghum can also be used in phytoremediation of contaminated areas owing to its heavy metal accumulating property. It has been proven that sorghum accumulates more heavy metal in tissues when compared with most plants known as tolerant. Extremely low transfer of heavy metals to grain by keeping them in root and leaf is a superior property of sorghum. In this respect, the grains can safely be used both as human and animal feed. In the present study, phytoremediation potential of sorghum plant in eliminating the heavy metals in multiple-heavy metal contaminated areas was discussed.

**Keywords:** *Sorghum, phytoremediation, heavy metal contamination*

---

## **1.INTRODUCTION**

Heavy metal contamination in soil systems due to industrialization was related with human activities as fertilizer and herbicide application, energy and fuel consumption, mineral and metal processing, and waste disposal. Various alternative methods are developed for cleaning contaminated areas. Plants can absorb and collect the heavy metals in their tissues as part of phytoextraction. For this purpose, selection of plants with heavy metal resistant properties and their cultivation may be key point in a new soil management strategy. Studies indicated that some cereal species as *Brassica juncea*, *Avena sativa*, *Zea mays*, *Hordeum vulgare*, *Helianthus annuus*, and *Lolium perenne* with high biomass exhibited heavy metal resistance [1-4]. In addition, fast growing *Salix viminalis*, and *Populus sp* produce excellent biomass and are potential candidates for phytoremediation [5].

Phytoremediation can increase the quality of soil via removing the heavy metals in a long-term process [6-8]. Plants with 50 to 500 times higher metal concentrations in above-ground organs compared to soil are referred as hyperaccumulators [9]. In other words, hyperaccumulators can store 100 to 1000 times higher metals in above ground tissues without any toxicity when compared with other plant species [10]. Nearly 450 plant species (only 0.2% of angiosperms) are recognized as hyperaccumulators [11]. Asteraceae, Brassicaceae, Fabaceae, Lamiaceae, Scrophulariaceae, and Euphorbiaceae are only a few of the families with such a feature [12]. While some of the species in these groups can accumulate more than one heavy metal with slow growth rate and low biomass, others accumulate only one type of heavy metal with high growth rate and high biomass [13]. Thus, higher heavy metal accumulators with high biomass production with remarkable economic value and their integration into soil ecosystem are preferred in phytoremediation processes [13-16]. Many chemicals as EDTA, HEDTA, NTA (nitrilotriacetic acid) and organic acids are used for increasing the efficiency of phytoremediation processes in pot and field trials [17-22]. Most of the studies related with phytoremediation are based on pot and aquaculture, but field trials are very limited in this regard [23-25].

The use of cereals in phytoremediation is advantageous in these processes due to its economical recovery. Sorghum bicolor is a resistant C4 plant with its high biomass, fast growth rate, and use as fodder [26, 27]. Thus, it is also considered to be promising plant for bioenergy production. Several studies have demonstrated that sweet sorghum have the ability to accumulate some heavy metals [28-30]. One preferable property of sorghum is that it can be cultivated every year and its biomass can easily be removed from the field together with stored heavy metals. Also, low accumulation of heavy metals in grain is another advantage and can be used as animal nutrient.

---

<sup>1</sup>Corresponding author: Ridvan Temizgul, Erciyes University, Department of Biology, 38039, Kayseri/Turkey.

[rtemizgul@erciyes.edu.tr](mailto:rtemizgul@erciyes.edu.tr)

<sup>2</sup>Mahmut Kaplan, Erciyes University, Department of Field Crops, 38039, Kayseri/Turkey. [mahmutkaplan5@hotmail.com](mailto:mahmutkaplan5@hotmail.com)

<sup>3</sup>Semih Yilmaz, Erciyes University, Department of Agricultural Biotechnology, 38039, Kayseri/Turkey. [yilmazsemh@yahoo.com](mailto:yilmazsemh@yahoo.com)

For all these reasons sorghum with low nitrogen requirement, high tolerance to different growing conditions, high biomass production, usability in bioenergy production, and most notably its ability to absorb multiple heavy metals, can be considered as potential phytoremediation agent in contaminated areas.

### Reasons for heavy metal accumulation

While the contamination of soils with heavy metals can be due to industrial and agricultural activities, it may also come up with the dissociation of heavy metal containing rocks and their transfer to water and soil systems. Dispersal of heavy metals to environment can rise due to exhaust gases (Pb), mining (Cr, B), industrial processes (Hg, Cd), paints (Pb, Cd), medical reasons (Hg), natural sources (Pb, Hg, Cr, Cd, B), thermal reactors (Pb, Hg, Cr, Cd), and agricultural origin [31].

### Prevention of heavy metal contamination

Many approaches are used in order to prevent soil contamination due to heavy metals. The most widely used of these approaches are;

1. Prohibiting the use of contaminated areas without interfering with pollutants
2. Immobilizing the contaminants in the region and taking the region into control
3. Transferring and storing the contaminated soil in a final disposal site
4. In-situ or ex-situ phytoremediation of contaminated soil.

### Adverse effects of heavy metals on organisms

Excessive accumulation of heavy metals has negative effects on the development of vegetative tissues and reproductive organs [32]. Thus heavy metals impair the physiological activities as transpiration, stomatal movement, water uptake, photosynthesis, enzyme activity, germination, protein synthesis, membrane stability, and hormonal balance in plants [33].

Heavy metals emerging from industrial activities can disperse to soil and water systems and reach to human and animals through food chain. Heavy metals can be classified into two groups as vital and non-vital according to their participation levels in biological processes. Heavy metals recognized as vital are required in certain levels in organisms, but excess accumulation result in toxicity. For example, once the Pb diffuse in blood, it can disperse to kidney, bone and other organs and cause abnormalities in brain and nervous system [34].

Cadmium (Cd) and related compounds generally result in hypertension, lung and prostate cancer, osteoporosis, anemia, tooth loss, and loss of sense of smell [35]. Chromium (Cr) effects carbohydrate, water and protein metabolism via ensuring the movement of insulin [34]. Copper (Cu) is an essential trace element due to its participation in the structure of many enzymes, but, excess accumulation result in abdominal pain, nausea, vomiting, and diarrhea [36].

### Phytoremediation

Phytoremediation is defined as cleaning process of contaminated areas from contaminants through the growth of accumulator plants [13]. Plants can clean the contaminated areas by absorbing, accumulating, storing and/or breaking up organic and inorganic contaminants. In this way, the stabilization or arrangement of the fields was aimed. Phytoremediation is environmentally friendly technique and important because of its sustainability and cost-effectivity compared to other breeding methods. Phytoremediation technology can be grouped in to five categories according to applicability and basic processes; phytoextraction, rhizofiltration, phytostabilization, phytovolatilization, and phytodegradation (Figure 1).

Studies indicated that the most appropriate plants in phytoremediation should have the characteristics as living in high heavy metal concentrations, bear rich and powerful root system, accumulate high amounts of heavy metals in harvested tissues, and produce high biomass [37]. It was reported that the most common hyperaccumulator plant *Thlaspi caeruledcens* can accumulate up to 26 gr of Zn [38].

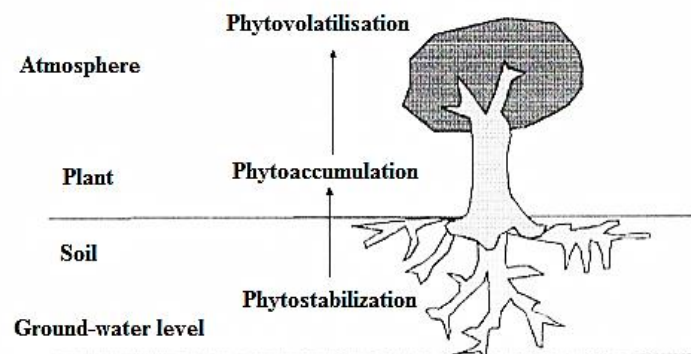

Figure 1. Basic mechanisms for removal of heavy metals through phytoremediation [39]

## The usability of sorghum in phytoremediation

The usability of sorghum under Pb, Cd, Cu and Zn contaminated field conditions was tested and at the end of 120 days of practice 0.35 kg/ha of Pb, 0.052 kg/ha of Cd, 1.44 Kg/ha of Zn and 0.24 kg/ha of Cu was obtained in only one harvest [40]. These researchers indicated that application of EDTA can considerably increase the elimination of Pb. In a study carried out with heavy metal contaminated sorghum seeds, it was evident that two fold increases in leaf and 2-4 fold increase in stem tissues were observed in terms of As and Pb accumulation compared to control. In the same study, although not as much as As and Pb, marked increase was also observed in Bi, Cd, Mn and Zn. However, significant increase was not observed in Cu accumulation [41]. In a study carried out by Angelova et al. [42], it was reported that sorghum plant accumulated 191.4-428.9 mg/kg of Pb, 16.9-35.5 mg/kg of Cu, 450.7-1.016 mg/kg of Zn and 7.5- 14.6 mg/kg of Cd in contaminated areas. They indicated that the highest amount of accumulation was observed in root, and the lowest was in grain.

Although sorghum cannot continuously accumulate Cd in root, it is higher than that of tolerant lettuce or other graminea family members known as tolerant [43]. Cd content in sorghum roots can be used to determine the level of soil contamination [44]. At the same time, it was reported that different sorghum species are the most appropriate plants in phytoremediation of Cu, Pb, Zn and Cd [42].

## Conclusion and recommendations

Heavy metal pollution is an important environmental problem due to its negative effects on human health and agricultural areas. Accumulation of pollutants in soil, affects not only soil fertility and functions of ecosystem but also human and animal health through the food chain. Heavy metal pollution in soil became a global problem via developments in industrial and mining activities and the development of irrigation with wastewater and widespread sludge treatment. Physical and chemical purification systems are not preferred because of the high cost of heavy metals as the most important polluters in soil and also difficulties in final elimination of the remnants. The use of phytoremediation is increasing day by day both for its low cost and environmentally friendly aspects. Many different plant species and technologies raise the possibility of using this technology. However, phytoremediation is not recognized as final disposal or removal method. Final removal is achieved by discarding the remnants of plants after phytoremediation processes with an appropriate method. If the remnants of plants can be used for secondary purpose as food is also an important aspect in terms of economic benefits. Sorghum plant accumulates heavy metals especially in root and leaf tissues but not in grains. Thus, the grains of sorghum can safely be harvested from contaminated areas and used in animal and human nutrition. At the same time, the stem of sorghum can be used in furniture industry as hardboard and provide a great return on the economy. However, long time period for remediation processes restricts use of this method. To overcome these limitations, it is necessary to understand molecular, genetic and biochemical mechanisms related to metal hyperaccumulation in plants. In addition, studies commonly conducted in aquaculture and pot trials should be performed in field conditions for determining the real phytoremediation capacity of the plants.

## REFERENCES

- [1]. D. E. Salt, R. D. Smith and I. Raskin, "Phytoremediation". *Annual Review of Plant Physiology and Plant Molecular Biology*, 49: 643-668, 1998. J. Breckling, Ed., *The Analysis of Directional Time Series: Applications to Wind Speed and Direction*, ser. Lecture Notes in Statistics. Berlin, Germany: Springer, 1989, vol. 61.
- [2]. Z. G. Shen, X. D. Li, C. C. Wang, H. M. Chen and H. Chua, "Lead phytoextraction from contaminated soil with high-biomass plant species" *Journal of Environmental Quality*, 31(6): 1893-1900, 2002.
- [3]. E. Meers, A. Ruttens, M. Hopgood, E. Lesage and F. M. G. Tack, "Potential of Brassica rapa, Cannabis sativa, Helianthus annuus and Zea mays for phytoextraction of heavy metals from calcareous dredged sediment derived soils", *Chemosphere*, 61(4): 561-572, 2005.
- [4]. M. Komarek, P. Tlustos, J. Szakova, W. Richner, M. Brodbeck, M. Sennhauser, "The use of maize and poplar in chelant-enhanced phytoextraction of lead from contaminated agricultural soils". *Chemosphere*, 67(4): 640-651, 2007.
- [5]. P. Vervaeke, S. Luyssaert, J. Mertens, E. Meers, F. M. G. Tack and N. Lust, "Phytoremediation prospects of willow stands on contaminated sediment: A field trial". *Environmental Pollution*, 126(2): 275-282, 2003.
- [6]. M. P. Benavides, S. M. Gallego and M. L. Tomaro, "Cadmium toxicity in plants", *Brazilian Journal of Plant Physiology*, 17, 21-34, 2005.
- [7]. A. K. Shanker, C. Cervantes, H. Loza-Tavera and S. Avudainayagam, "Chromium toxicity in plants", *Environment International*, 31, 739-753, 2005.
- [8]. R. B. Meagher, "Phytoremediation of toxic elemental and organic pollutants", *Current Opinion in Plant Biology*, 3, 153-162, 2000.
- [9]. S. Clemens, "Toxic metal accumulation, responses to exposure and mechanisms of tolerance in plants", *Biochimie*, 88, 1707-1719, 2006.
- [10]. R. R. Brooks, "General Introduction. In: Brooks, R.R. (ed.). Plants that hyperaccumulate heavy metals: their role in phytoremediation, microbiology, archaeology, mineral exploration and phytomining". *CAB International*, New York, pp. 1-14, 1998.

- [11]. R. D. Reeves, "Hyperaccumulation of trace elements by plants. In: Morel, J.L., Echevarria, G. ve Goncharova, N. (Eds.). Phytoremediation of metal-contaminated soils", *NATO Science Series: IV: Earth and Environmental Sciences*, Springer, NY, pp. 1-25, 2006.
- [12]. A. G. L. Assuncao, H. Schat and M. G. M. Aarts, "Thlaspi caerulescens, an attractive model species to study heavy metal hyperaccumulation plants", *New Phytologist*, 159(2), 351-360, 2003.
- [13]. A. R. Memon, D. A. Aktoprakligül, Özdemir and A. Vertii, "Heavy metal accumulation and detoxification mechanisms in plants", *Turkish Journal of Botany*, 25, 111-121, 2001.
- [14]. T. McIntyre, "Phytoremediation of heavy metals from soils", *Advances in Biochemical Engineering/Biotechnology*, 78, 97-123, 2003.
- [15]. B. Nowack, R. Schulin and B. Robinson, "Critical assessment of chelant-enhanced metal phytoextraction". *Science of the Total Environment*, 40(17): 5225-5232, 2006.
- [16]. M. W. H. Evangelou, M. Ebel and A. Schaeffer, "Chelate assisted phytoextraction of heavy metals from soil. Effect, mechanism, toxicity, and fate of chelating agents". *Chemosphere*, 68(6): 989-1003, 2007.
- [17]. M. J. Blaylock, D. E. Salt, S. Dushenkov, O. Zakharova, C. Gussman, Y. Kapulnik et al., "Enhanced accumulation of Pb in Indian mustard by soil-applied chelation agents". *Environmental Science and Technology*, 31(3): 860-865, 1997.
- [18]. J. W. Huang, J. Chen, W. B. Berti, S. D. Cunningham, "Phytoremediation of lead-contaminated soils: role of synthetic chelates in lead phytoextraction". *Science of the Total Environment*, 31(3): 800-805, 1997.
- [19]. A. Kayser, K. Wenger, A. Keller, W. Attinger, H. R. Felix, S. K. Gupta et al., "Enhancement of phytoextraction of Zn, Cd and Cu from calcareous soil: the use of NTA and sulfur amendments". *Science of the Total Environment*, 34(9): 1778-1783, 2000.
- [20]. X. Ke, P. J. Li, Q. X. Zhou, Y. Zhang, T. H. Sun, "Removal of heavy metals from a contaminated soil using tartaric acid". *Journal of Environmental Sciences*, 18(4): 727-733, 2006.
- [21]. H. Q. Wang, S. J. Lu, H. Li and Z. H. Yao, "EDTA-enhanced phytoextraction of lead contaminated soil by *Bidens maximowicziana*". *Journal of Environmental Sciences*, 19(12): 1496-1499, 2007.
- [22]. Q. T. Wu, J. C. Deng, X. X. Long, J. L. Morel and C. Schwartz, "Selection of appropriate organic additives for enhancing Zn and Cd phytoextraction by hyperaccumulators". *Journal of Environmental Sciences*, 18(6): 1113-1118, 2006.
- [23]. D. Hammer and C. Keller, "Phytoextraction of Cd and Zn with *Thlaspi caerulescens* in field trials". *Soil Use and Management*, 19(22): 144-149, 2003.
- [24]. S. P. McGrath, E. Lombi, C. W. Gray, N. Caille, S. J. Dunham and F. J. Zhao, "Field evaluation of Cd and Zn phytoextraction potential by the hyperaccumulators *Thlaspi caerulescens* and *Arabidopsis halleri*". *Environmental Pollution*, 141(1): 115-125, 2006.
- [25]. P. Zhuang, Q. W. Yang, H. B. Wang and W. S. Shu, "Phytoextraction of heavy metals by eight plant species in the field". *Water, Air and Soil Pollution*, 184(1-4): 235-242, 2007.
- [26]. D. R. Buxton, I. C. Anderson and A. Hallam, "Intercropping sweet sorghum into alfalfa and reed canarygrass to increase biomass yield". *Journal of Production Agriculture*, 11: 481-486, 1998.
- [27]. P. W. Unger, "Alternative and opportunity dryland crops and related soil conditions in the Southern Great Plains". *Agronomy Journal*, 93(11): 216-226, 2001.
- [28]. D. M. Kumawat and P. S. Dubey, "Sorghum straw as an efficient remover of metal from wastewater". *Current in Science*, 61: 47-49, 1991.
- [29]. Y. J. An, "Soil ecotoxicity assessment using cadmium sensitive plants". *Environmental Pollution*, 127(1): 21-26, 2004.
- [30]. L. Marchiol, G. Fellet, D. Perosa and G. Zerbi, "Removal of trace metals by *Sorghum bicolor* and *Helianthus annuus* in a site polluted by industrial wastes: a field experience". *Plant Physiology and Biochemistry*, 45(5): 379-387, 2007.
- [31]. Ö. Vanlı and M. Yazgan, "Ağır metallerle kirlenmiş toprakların temizlenmesinde fitoremediasyon tekniği". <http://www.tarimsal.com/fitoremediasyon/fitoremediasyon.htm>, 2008, (15.08.2016).
- [32]. N. Gür, A. Topdemir, Ö. Munzuroğlu, and D. Çobanoğlu, "Ağır Metal İyonlarının (Cu+2, Pb+2, Hg+2, Cd+2) *Clivia* sp. Bitkisi Polenlerinin Çimlenmesi ve Tüp Büyümesi Üzerine Etkileri". *F.Ü. Fen ve Matematik Bilimleri Dergisi*, 16(2), 177-182, 2004.
- [33]. C. D. Kennedy and F.A. N. Gonsalves, "The action of divalent zinc, cadmium, mercury, copper and lead on the trans-root potential and efflux of excised roots", *J. Exp. Bot.*, 38, 800-817, 1987.
- [34]. Ö. Kahvecioğlu, G. Kartal, A. Güven, and S. Timur, "Metallerin Çevresel Etkileri-I". [www.metalurji.org.tr/dergi/dergi136/d136\\_4753.pdf](http://www.metalurji.org.tr/dergi/dergi136/d136_4753.pdf), 2006.
- [35]. B. Yağmur, H. Hakerlerler and R. Kılınç, "Gübreler ve İnsan Sağlığı". *Çiftçi Dergisi* sayı: 2, 2003.
- [36]. Anonim, "Bakır". <http://www.food-info.net/tr/min/copper.htm>, 2006.
- [37]. R. D. Reeves and A. J. M. Baker. "Metal-accumulating plants. In: Phytoremediation of toxic metals: using plants to clean up the environment", Raskin, I. and B.D. Ensley (Eds.). Wiley, New York, pp: 193-229, 2000.
- [38]. M. M. Lasat, "Phytoextraction of metals from contaminated soil: A review of plant/ soil/ metal interaction and assessment of pertinent agronomic issues", *Journal of Hazardous Substance Research*, 2(5), 1-25, 2000.
- [39]. F. O. Kocaer and H. S. Başkaya, "Metallerle Kirlenmiş Toprakların Temizlenmesinde Uygulanan Teknolojiler". *Uludağ Üniversitesi Mühendislik Mimarlık Fakültesi Dergisi*, Cilt 8, Sayı 1. 2003.
- [40]. Z. Ping, S. Wensheng, L. Zhian, L. Bin, L. Jintian and S. Jingsong, "Removal of metals by sorghum plants from contaminated land". *J Environ Sci* 21: 1432-1437, 2009.
- [41]. J. M. Murillo, T. Maranon, F. Cabrera and R. Lopez, "Accumulation of heavy metals in sunflower and sorghum plants affected by the Guadamar spill". *The Science of the Total Environment*, 242: 281-292, 1999.
- [42]. V. R. Angelova, R. V. Ivanova, V. A. Delibaltova and K. I. Ivanov "Use of sorghum crops for in situ phytoremediation of polluted soils". *Journal of Agricultural Science and Technology A 1*: 693-702, 2011.
- [43]. A. P. Pinto, A. M. Mota, A. de Varenne and F. C. Pinto, "Influence of organic matter on the uptake of cadmium, zinc, copper and iron by sorghum plants", *Science of the Total Environment* 326: 239-247, 2004.
- [44]. J. A. Youn, "Soil ecotoxicity assessment using cadmium sensitive plants", *Environmental Pollution* 27: 1-26, 2004.



# Internet Access And Digital Skepticism: A Preliminary Analysis

Naciye Guliz Ugur<sup>1</sup>, Merve Turkmen Barutcu<sup>2</sup>

---

## Abstract

Technology readiness is multifaceted, varies from one individual to the next, and predicts and explains a person's responses to technologies. This study investigates whether internet access contributes to technology readiness segments of people. The Internet is one of the most powerful media of information and communication in human history, it has opened massive opportunities for economic development across the globe. This research aims to analyze technology readiness level of people who access Internet and evaluate their technology readiness levels in terms of the technology readiness segments. The research is conducted on 300 participants and data is gathered by using Technology Readiness Index (TRI) survey, which was developed by Parasuraman (2000) to measure users' intention to technology usage. The Technology Readiness Index is based on four main categories of attitudes toward technology which are optimism, innovativeness, discomfort, and insecurity. Based on participants' TRI dimensions score, each participant is classified into five TRI segments; explorers, pioneers, skeptics, paranoids and laggards. In the light of the findings and limitations, some recommendations were made to tackle the technology readiness problem.

**Keywords:** Technology readiness index, technology adoption, TRI, internet users, digital skepticism

---

## 1. INTRODUCTION

Explaining why some employees accept technology while others don't has been the focus of much research over the past years. Some researchers have looked at the diffusion of innovation literature, the theory of reasoned action, and the theory of planned behavior (Meng, Elliot & Hall, 2010). More recent, the technology acceptance model has become popular in addressing this issue (Tsikriktsis, 2004). An attempt has been made to integrate all these competing approaches and resulted in the development of the Unified Theory of Acceptance and Use of Technology by Venkatesh, Morris, Davis, and Davis (2003).

Technology readiness (TR) refers to "people's propensity to embrace and use new technologies for accomplishing goals in home life or work" according to Parasuraman (2000, p. 308). A combination of positive and negative feelings regarding technology exist that can impact a person's willing to embrace a new technology (Duvall, 2012). Parasuraman found that although people are generally optimistic about technology, there is still a great deal of insecurity and even technology optimists and innovators experience technology driven anxieties (2000).

Ironically, although new technologies are at increasing rates, ample anecdotal as well as survey based evidence suggests signs of growing consumer frustration and disillusionment (Parasuraman, 2000). Another study based on extensive qualitative research on peoples' reactions to technology, Mick and Fournier (1998), identified eight technology paradoxes with which consumers have to cope: control/chaos, freedom/enslavement, new/obsolete, competence/incompetence, efficiency/inefficiency, fulfills/creates needs, assimilation/isolation, and engaging/disengaging.

The nineties witnessed a major revolution with the invention of the first electronic digital computers. Till then, the term Internet was practically unknown to most people. However, today, the Internet has become the most powerful tool for people around the world. With the advent of Internet, our earth has virtually reduced in size and has attained the form of a global village. The Internet has helped bring the world closer. Receiving news from across the world, accessing knowledge resources, and shopping online are simply a click away.

The Internet has tremendous potential and a lot to offer in terms of services. One of the greatest advantages of internet is that the majority of the people get used to technological revolution by using internet. In this study, adoption of new technologies are examined (Parasuraman, 2000), and accordingly, we measured internet users' attitude toward technology to specify their technology readiness segmentation. This study will mainly explore the digital readiness of the community which have just walk through the digital bridge and their attitude toward new technologies.

Previous studies have been conducted using the Technology Readiness Index (TRI) to clarify people's readiness to adopt new technologies. Results demonstrated that this model is able to predict people's readiness to adopt and use technology services

---

<sup>1</sup> Sakarya University, Department of Management Information Systems, 54187, Serdivan, Sakarya, Turkey. [ngugur@sakarya.edu.tr](mailto:ngugur@sakarya.edu.tr)

<sup>2</sup> Sakarya University, Department of Business, 54187, Serdivan, Sakarya, Turkey. [mturkmen@sakarya.edu.tr](mailto:mturkmen@sakarya.edu.tr)

and products (e.g. Chen & Li, 2010; Lanseng & Andreassen, 2007). However, to our knowledge, Turkey has no scholarly studies especially about internet users' attitudes toward technology. In this research, we studied internet users' technology readiness level and we also investigate the relationship between participants' demographics and their segments. TRI was chosen for this study as it measures readiness to use technology in home life and at work; this relates directly to our study since people who use internet and stay on the positive side of the digital divide seems more familiar to technology and developments. Although they connect the world by internet, they can still feel uncomfortable and insecure.

## 2.LITERATURE REVIEW

Rogers (2003) has defined technology as "a design for instrumental action that reduces the uncertainty in the cause-effect relationship involved in reaching a desired outcome" (p. 13). The question of how to use a design for instrumental action is at the core of the field of technology adoption. As technology innovation increases, the degree to which consumers and users are conversant with and ready to use technology is of growing importance.

It is necessary to gain an understanding of consumers' adoption of new technologies and its antecedents. In explaining what is driving consumer behavior, Fishbein (1980) developed the theory of reasoned actions (TRA), which explains the association between attitude and buying behavior. The TRA asserts that the "attitude toward buying and subjective norm are the antecedents of performed behavior" (Ha, 1998; Pelsmacker et al., 2005). Furthermore, a particularly relevant proposition was offered by Parasuraman (2000) in order to measure people's readiness to use and interact with technology.

The technology readiness model is based on Mick and Fournier's (1998) facets of potential drivers and inhibitors as defined by eight paradoxes. Based on their qualitative research, Mick and Fournier observed that consumers have to cope with control and chaos, freedom and enslavement, new and obsolescence, competence and incompetence, efficiency and inefficiency, fulfillment and generation of needs, assimilation and isolation, engagement and disengagement in their reaction to technology.

As implied by each pair of dichotomies identified by Mick and Fournier (1998), technology may prompt positive and negative feelings that could affect technology-dependent outcomes. Based on consumer responses to questions, Parasuraman (2000) observed that positive feelings are enabling factors that include optimism and innovativeness while the negative feelings are inhibiting factors that include discomfort and insecurity.

Technology readiness refers to "a person's propensity to embrace and use new technologies for accomplishing goals in home life and at work" (Parasuraman, 2000). It is much more a mental state than a measure of technical competency. The construct is a combination of technology-related beliefs that collectively determine a person's predisposition to interact with technology-based products and services. Technology readiness is based on the idea that customer beliefs and behaviors correspond to a different model when technology is involved. Technology readiness is multifaceted, varies from one individual to the next, and predicts and explains responses to technologies (Parasuraman & Colby, 2001).

Technology readiness asserts that people have both positive and negative views about technology-based products and services (Parasuraman, 2000). Although positive feelings propel people toward technologies, negative feelings may hold them back, and the relative dominance of the two types of feelings is likely to vary across individuals (Parasuraman). Using the construct, people can be arrayed along a technology beliefs continuum, anchored by receptiveness at one end and resistance at the other (Parasuraman & Colby, 2001). People's positions on this continuum can be expected to correlate with their propensity to embrace and employ technology (Parasuraman, 2000).

As the result of multiyear researches Parasuraman, (2000) developed TRI. Parasuraman (2000) introduced the concept of this index as a measure of "technology readiness" phenomenon. The TRI is a multiple-statement index with sound psychometric properties that companies can use to gain an in-depth understanding of the readiness of their customers to embrace and interact with technology, especially computer/Internet-based technology. In starting position 44 questions were developed based on group interviews, afterwards these questions were again tested by other studies and were reduced to 36 questions. TRI consists of 36 different technology-belief statements, with roughly half of the statements relating to beliefs that contribute to technology readiness, and the remaining relating to beliefs that inhibit technology readiness.

TRI is based on four main categories of attitudes toward technology which are optimism, innovativeness, discomfort, and insecurity (Parasuraman & Colby, 2001). Parasuraman, (2001) defined innovativeness as one's tendency to be a technology pioneer and thought leader, and optimism as a positive view of technology and belief that it offers flexibility, efficiency in their lives. Discomfort was defined as a perceived lack of control over technology and feeling of being overpowered by it, insecurity was defined as distrust of technology and skepticism about its capability to work in a proper way.

This index can be viewed as an overall state of mind resulting from a gestalt of mental enablers and inhibitors that collectively determine a person's predisposition to use new technologies. Of these four dimensions, optimisms and innovativeness are drivers of technology readiness while discomfort and insecurity are inhibitors.

The combination of scores on the four technology readiness dimensions represents a person's overall technology readiness (Parasuraman and Colby, 2001). Several empirical studies provide the insight that the TRI is capable of capturing the relationship between technology readiness and technology usage behaviors (for example, Colby and Albert, 2003; Farby, 2004; NTRS, 1999, 2000, 2001; Parasuraman and Colby, 2001).

Based on individual's technology readiness score and the TRI, Parasuraman and Colby (2001) further classified technology customers into five technology readiness segments, namely, explorers, pioneers, skeptics, paranoids, and laggards. They stated that "explorers" are highly optimistic and innovative; they score high in technology readiness and are highly motivated and fearless to try new technology once it appears in the market. Also they are highly motivated and confident in their ability to

make technology work. They are younger, generally male, have a higher income, and are better educated than members of other segments.

“Pioneers” are relatively early adopters of new technology but are simultaneously held back by inherent discomfort and insecurity; they are innovative yet cautious. Consumers in this segment have an average income and education, are equally likely to be male or female, and tend to be younger relative to the remaining segments (Parasuraman & Colby, 2001).

The “Skeptics” segment represents the middle segment in the five segmentation profiles. Skeptics are fairly techno-ready; they are lowly motivated and need to be convinced of the benefits of using the emerging technology. They just lack enthusiasm, and are less likely to believe technology offers them more control over their lives. They are low on the driver and inhibitor dimensions. Consumers in this segment are of average age, income, and education level, and half are males (Parasuraman & Colby, 2001).

“Paranoids” are the insecure; they are later adopters of new technology. Though paranoids are convince of the benefits of the technology, at the same time, they are concerned about the risks and barriers of technology adoption. They adopt technologies when growth begins to decline. This segment is slightly older, more likely to be female, less affluent and less educated (Parasuraman & Colby, 2001).

“Laggards” are the resistant ones, who are likely the last adopters of new technology; and they may never use new technology unless they are forced to do so (Lai, 2008). They are the opposite of Explorers, low on the driver dimension and high on discomfort and insecurity. Laggards are the oldest segment in age, mostly female (67%), have the lowest income and have the lowest levels of education (Parasuraman & Colby, 2001).

The four technology readiness dimensions and technology adoption segmentation profiles discussed above are based on US data, with a relatively small percentage of mature consumers in the sample (Parasuraman & Colby, 2001). Several authors (Lam, Chiang, & Parasuraman, 2008; Lin & Hsieh, 2006; Tsiriktsis, 2004; van der Rhee, Verma, Plaschka, & Kickul, 2007; Victorino et al., 2009) examined the four dimensions of technology readiness and approved all of them using a 10-statement and 36-statement index. On the other hand, Liljander et al. (2006) were able to emerge only the two major dimensions using a 12-statement index. Relevant studies using a simplified index to measure technology readiness didn't use the same statements thus it seems inappropriate to compare the results. In terms of the segmentation profile, in the literature, two prior studies examined the five segments but couldn't reach the same findings. Tsiriktsis (2004) in a UK study defined four segments, except Paranoids. Victorino et al., (2009) in a study of US hotel users profiled three segments: Innovators, Paranoids and Laggards. Prior studies found that explorers and pioneers are high in technology readiness and tend to embrace new technology earlier than the others (e.g. Parasuraman and Colby, 2001; Lai et al., 2005).

According to literature review, it is expected that individuals who are more technology ready are likely to be keener to use technology-based products or services. Furthermore, it's assumed that the people who use internet are more technology-friendly. Connecting the internet is like the first step of walking through the technology gates. We aimed to measure the technology readiness level of the people who use internet and at least can fill an online survey. Does jumping through the digital divide is enough for people to trust technology? Do people, who use internet, trust online platforms? Do they feel confident about online actions? In the following sections of this paper, the TRI and segmentation profiles will be examined in the internet users' context.

### 3.METHODOLOGY

Data for the current study were gathered with convenience sampling with the purpose of facilitating the data collection to minimize the costs and save time. Since the questionnaire was going to be applied to internet users, an online survey is prepared.

The conceptualization of the online survey was based on the existing TRI. The survey is conducted on Turkish users, therefore we translated the original TRI, which was developed by Parasuraman (2000) in English. The survey consisted of four dimensions; innovativeness, optimism, insecurity and discomfort. We used the 36-statement index to measure their technology readiness levels.

A short instrument consisting of 8 demographic questions, 36 statements based upon a 5-point Likert scale (strongly disagree, disagree, neutral, agree, strongly agree) was administered to internet users. The 5-point response scale wasn't containing “no opinion” option specifically to prevent participants from simply taking the “no opinion” perspective in answering the questions. Survey link is shared on social media platforms and via e-mail chains. At the end of one month data gathering period, 300 internet users participated the survey. This study was conducted to reach Turkish internet users who: are female and male, are highly and lowly educated, have high and low income, have any attitude toward technology.

The data analysis in this study was divided into two phases. Phase I involved describing the sample profile and the data collected. Phase II involved preparing the data for analysis. The results were gathered by entering the survey data into SPSS. Based on participants' TRI score, each one is classified into five TRI segments; explorers, pioneers, skeptics, paranoids and laggards. After the classification, results are analyzed within the demographic variables.

### 4.ANALYSIS AND RESULTS

We had a total of 300 participants in our study. The ages of the respondents ranged from 18 to 65 but were more biased (49%) toward the younger generation between ages 18 and 30 years old. The distribution of males and females was quite close (57,7

% males to 42,3% females). Most of respondents had an undergraduate degree, and had a monthly income of 2001 TL to 3500 TL.

In our study, we examined the four dimensions of technology readiness and approved all of them using the 36-statement index. The findings in Table 1 represent the distribution of participants within the five segments. 24% of the sample could not assigned to any segment.

Table 1: Segmentation

		Frequency	Percent	Valid Percent	Cumulative Percent
Valid	Explorers	17	5,7	7,5	7,5
	Pioneers	153	51,0	67,1	74,6
	Skeptics	2	,7	,9	75,4
	Paranoids	50	16,7	21,9	97,4
	Laggards	6	2,0	2,6	100,0
	Total	228	76,0	100,0	
	Unassigned	72	24,0		
Total		300	100,0		

Our findings prove that internet access defeats skepticism and laggardness. People, who overcome digital divide problem and identify the advantages of Internet, lean towards technological evolution and becomes ready for technology.

According to the literature on TRI and technology adoption, we developed several hypothesis. Studies have shown that the typical adopter of a new technology is younger, has a high income, has a high level of education, and is a male (Rogers, 2003; Laukkanen & Pasanen, 2008; Chinn & Fairlie, 2004; Marchionni & Ritchie, 2007). Therefore, in our research about internet users' technology readiness, the following hypothesis is proposed:

Hypothesis 1: Males are more likely to score higher on the enablers of technology readiness (Optimism and Innovativeness) and lower on the inhibitors of technology readiness (Discomfort and Insecurity) than females.

The results of our study meet the findings of prior studies, males scored higher on enablers and lower on the inhibitors of technology readiness. 41,2% of the explorers is female where 58,8% is male. Similar to this finding, majority of pioneers is male. Females and males distribute equal at skeptics. Therefore, majority of paranoids and laggards are female. Hypothesis 1 is accepted.

In terms of age, the findings of Rogers (1995) and of Meuter et al. (2003) show that age is the most important demographic factor in explaining the adoption of technologies. Previous studies indicate a negative relationship between age and the adoption of technology (Joines et al., 2003; Hertzog & Hultsch, 2000; Bigne et al. 2005). Therefore, the following hypothesis is proposed:

Hypothesis 2: Young people are more likely to score higher on the enablers of technology readiness (Optimism and Innovativeness) and lower on the inhibitors of technology readiness (Discomfort and Insecurity) than old people.

In our study, young (18-30) and middle aged (31-45) participants scored slightly different at TRI, on the other hand the older group (older than 45) seemed more paranoid than others. 70% of the young participants and 66,3% of the middle aged are located in in the group of pioneers. Majority of the old people (over 45) seems also as pioneers (57,1) but 35,7% of them is in the segment of paranoids and 7,1% is in laggards. Paranoids also consists 20,2% of the young group and 20,5% of the middle aged group. Accordingly, hypothesis 2 is partially accepted. Young (18-30) and middle aged (31-45) groups distribute nearly at equal percentages within groups, the accepted part of the hypothesis is the significant difference between the old group and the others.

Technology adopters differ with regard to their level of education as early adopters tend to have a higher level of education (Rogers, 1995). This could be explained by their perceived ability to assimilate more knowledge than people with lower levels of education (Rogers, 1995). Previous studies have shown a positive relationship between level of education and technology adoption (Porter & Donthu, 2006). Thus, the following hypothesis is proposed:

Hypothesis 3: More educated people are more likely to score higher on the enablers of technology readiness (Optimism and Innovativeness) and lower on the inhibitors of technology readiness (Discomfort and Insecurity) than low educated people.

For the hypothesis 3, our results revealed the opposite of the prior studies' findings. Majority of all the groups showed up in the group of pioneers. 73,5% of the people who are graduated from a high school or lower score as pioneers, also the greatest portion of pioneers is undergraduate. The most educated participants who are graduated from masters or doctoral degree don't look different according to other income groups, even they seem similar with the lowest educated participants. Hypothesis 3 is rejected.

The adoption of technological products requires financial investment. According to Taglang (2000), people with lower income resist technologies that require continuing or high costs. Some studies have shown a positive relationship between level of income and technology adoption (Taglang, 2000; Li et al., 1999) Therefore, the following hypothesis is proposed:

Hypothesis 4: High income people are more likely to score higher on the enablers of technology readiness (Optimism and Innovativeness) and lower on the inhibitors of technology readiness (Discomfort and Insecurity) than low income people.

Contrary to expectations, there isn't a significant difference between the income groups. Similar to education distribution within segments, the majority of all income groups ranked as pioneers. 73,2% of the participants who earn over 3500 TL score as pioneers, 63,7% of the middle group (2000-3500 TL) and 68,2% of low income (below 2000 TL) are also in this segment. When we analyze paranoids, majority of the group consists of the middle income participants with 42%. The richest participants whose income is more than 3500 don't show significant difference according to other income groups, even they seem similar with the lowest income participants. Therefore, hypothesis 4 is rejected.

## 5.CONCLUSION

Various studies have revealed technology readiness of the population in Turkey. However, until now, there has been no examination of technology readiness of especially the internet users. This study is one of the few studies that have been conducted in developing countries. This study aimed to uncover technology readiness of people who overcome the digital divide problem and analyze if there exists a relationship between several demographics and technology readiness score. The study was based on a survey conducted in Turkey using the TRI, which was adapted from Parasuraman (2000) and its four dimensions: Innovativeness, Optimism, Discomfort and Insecurity. SPSS was run to analyze the data collected and test the research hypotheses. The findings of the study revealed that gender and youth have an influence on people's attitude toward technology, but income and education seem ineffective on internet users' technology readiness. Based on these findings, this study offers a number of recommendations for improving Turkish people's level of technology readiness. Our research findings prove that internet access defeats skepticism and laggardness. People, who overcome digital divide problem and identify the advantages of Internet, lean towards technological evolution and becomes ready for technology. In our study, contrary to expectations, internet users' education and income level analyzed as ineffective on technology readiness. Majority of the literature on technology or digital readiness underline that socio-economic status, namely income and education have a negative effect on personal development, so these disadvantaged people stay behind. This study reveals that if people connect to internet their disadvantages in education and income can disappear. Therefore, the government should make complementary investments to solve the digital divide problem, because it's seen from the literature that offline community can't improve their readiness level. Finally, great portion of the participants scored as explorers or pioneers, namely internet users passed on the TRI exam. If the policy makers can make more people connect the web, the technology readiness of the population can rise.

## REFERENCES

- [1]. E. Bigne, C. Ruiz and Sanz, S., "The impact of internet user shopping patterns and demographics on consumer mobile buying behavior," *Journal of Electronic Commerce Research*, 6(3), 18, 2005.
- [2]. S.Chen and Li, S., "Consumer adoption of e-service: Integrating technology readiness with the theory of planned behavior," *African Journal of Business Management*, 4(16), 3556-3563, 2010.
- [3]. M.D. Chinn and Fairlie, R.W., "The determinants of the global digital divide: a cross-country analysis of computer and internet penetration," discussion paper series. *Institute for the Study of Labour, Bonn*. 2004.
- [4]. C.L. Colby and Albert, T., "The role of culture in technology adoption in the US: results of the African American and Latino technology readiness survey", *Rockbridge News*, Vol. 2, 2003.
- [5]. S. Farby, "Five technology consumers to watch", *Rockbridge News*, Vol. 2, 2004.
- [6]. M. Fishbein, "A theory of reasoned action: some application and implications", *Nebraska Symposium on Motivation, University of Nebraska Press, Lincoln, NE*, Vol. 27, pp.65-116, 1980.
- [7]. C. L. Ha, "The theory of reasoned action applied to brand loyalty," *The Journal of Product and Brand Management*, 7(1), 51-6, 1998.
- [8]. C. Hertzog and Hultsch, D. F., "Metacognition in adulthood and old age" in: Craik F, Salthouse T (eds.). *The handbook of aging and cognition*, second edition. Mahwah, NJ: Lawrence Erlbaum Associates, 417-466, 2000.
- [9]. J., Joines, C., Scherer and Scheufele, D., "Exploring Motivations for Consumer Web Use and Their Implications for E-Commerce", *Journal of Consumer Marketing*, 20(2): 90-109, 2003.
- [10]. H-C., Lai, Y-C. Chiu and Leu, H-D., "Innovation capacity comparison of China's information technology industrial clusters: The case of Shanghai, Kunshan, Shenzhen and Dongguan," *Technology Analysis & Strategic Management*, Vol.17, No.3, pp. 293-315, 2005.
- [11]. M-L. Lai, "Technology readiness, internet self-efficacy and computing experience of professional accounting students," *Campus-Wide Information Systems*, 25(1), 18-29, 2008.
- [12]. S. Y., Lam, J., Chiang and Parasuraman, A., "The effects of the dimensions of technology readiness on technology acceptance: an empirical analysis," *Journal of Interactive Marketing*, 22(4), 19-39, 2008.
- [13]. E., Lanseng and Andreassen, T., "Electronic healthcare: a study of people's readiness and attitude toward performing self-diagnosis," *Journal of Service Management*, 18(4), 394-417, 2007.
- [14]. , T., Laukkanen and Pasanen, M., "Mobile banking innovators and early adopters: How they differ from other online users?," *Journal of Financial Services Marketing*, 13(2), 86-94, 2008.

- [15]. H., Li, C., Kuo and Russell, M., "The impact of perceived channel utilities, shopping orientations, and demographics on the consumer's online buying behavior," *Journal of Computer-Mediated Communication*, 5(2), 1999.
- [16]. V., Liljander, F., Gillberg, J., Gummerus, and van Riel, A., "Technology readiness and the evaluation and adoption of self-service technologies," *Journal of Retailing and Consumer Services*, 13, 177-191, 2006.
- [17]. J.-S. C., Lin and Hsieh, P.-I., "The role of technology readiness in customers' perception and adoption of self-service technologies," *International Journal of Service Industry Management*, 17(5), 497-517, 2006.
- [18]. C. Marchionni and Ritchie, J., "Organizational factors that support the implementation of a nursing Best Practice Guideline," *Journal of Nursing Management*, 16(3), 74-266, 2007.
- [19]. M. L., Meuter, A. L., Ostrom, M. J., Bitner and Roundtree, R., "The influence of technology anxiety on consumer use and experiences with self-service technologies," *Journal of Business Research*, 56: 899-906, 2003.
- [20]. D. G. Mick and Fournier, S., "Paradoxes of technology: Consumer cognizance, emotions, and coping strategies," *Journal of Consumer Research*, 25, pp. 123-47, 1998.
- [21]. NTRS (1999) "The 1999 National Technology Readiness Survey", Retrieved, Oct 27, 2014, Available: [www.technoreadymarketing.com](http://www.technoreadymarketing.com).
- [22]. NTRS (2000) "The 2000 National Technology Readiness Survey", Retrieved, Oct 27, 2014, Available: [www.technoreadymarketing.com](http://www.technoreadymarketing.com).
- [23]. NTRS (2001) "The 2001 National Technology Readiness Survey", Retrieved, Oct 27, 2014, Available: [www.technoreadymarketing.com](http://www.technoreadymarketing.com).
- [24]. A. Parasuraman, "Technology readiness index (TRI): a multiple-item scale to measure readiness to embrace new technologies," *Journal of Service Research:JSR*, 2(4), 307, 2000.
- [25]. A. Parasuraman, and Colby, C., *Techno-Ready Marketing: How and Why Your Customers Adopt Technology*, The Free Press, New York, NY, 2001.
- [26]. P. D., Pelsmacker, W., Janssens and Mielants, C., "Consumer values and fair-trade beliefs, attitudes and buying behavior," *International Review on Public and Non Profit Marketing*, 2, 50-69, 2005.
- [27]. C., Porter and Donthu, N., "Using the technology acceptance model to explain how attitudes determine internet usage: the role of perceived access barriers and demographics," *Journal of Business Research*, 59(9), 999-1007, 2006.
- [28]. E.M. Rogers, *Diffusion of Innovation*. Fourth edition, NY: Free Press, 1995.
- [29]. E. M. Rogers, *Diffusion of innovations* (5th ed.). New York, NY: Free Press, 2003.
- [30]. (2000) K. Taglang, Content and the Digital Divide: What do people want? Retrieved Oct 10, 2014, Available: <http://digitaldividenetwork.org/content/stories/index.cfm?key=14>.
- [31]. N. Tsikriktsis, "A technology readiness-based taxonomy of customers: a replication and extension," *Journal of Service Research*, 7(1), 42-52, 2004.
- [32]. B., van der Rhee, R., Verma, G., Plaschka and Kickul, J., "Technology readiness, learning goals, and e-learning: searching for synergy," *Decision Sciences Journal of Innovative Education*, 5(1), 127-149, 2007.
- [33]. L., Victorino, E., Karniouchina and Verma, R., "Exploring the use of the abbreviated technology readiness index for hotel customer segmentation," *Cornell Hospitality Quarterly*, 50(3), 342-359, 2009.

# Biometric Solutions For Is Security

Naciye Guliz Ugur<sup>1</sup>, Merve Turkmen Barutcu<sup>2</sup>

---

## Abstract

*In this paper, we review the potential use of biometric technologies as viable, useful, flexible and arguably cost-effective IS security control devices in organizations. Based upon an exploratory analysis of top business publication mentions of uses of biometrics for security controls, we introduce our view that deployments of biometrics as IS security controls continue to be remarkably underutilized and underdeveloped compared to the potential that such technologies might yield to organizations. Applying theory associated with the MIS economics reference discipline literature, we study the possible broader issues that might indicate that there are underlying limitations to widespread adoptions of biometrics technologies as physical control mechanisms for IS security. Finally, we make suggestions that might alleviate these hypothesized economic and social roadblocks prohibiting adoption of the theoretically promising yet pragmatically limited biometric solutions to enhancing the overall IS security environment.*

**Keywords:** IS Security, Biometric Security, Biometrics, Security Tools, Biometric Authentication

---

## 1. INTRODUCTION

Biometric security applications are wide ranging. We see examples of successful biometrics identity uses for patient data access identification in healthcare environments, for safety in air travel, in finance for banking ATM customer identification, in casinos for identifying known card sharks and criminals, in schools for identifying students, in bars and suntan booths for payments, in corporations for PC network access, and in government for welfare payments, national IDs for voter registration, and military applications. Biometrics technologies are used to secure transfer payments and to add controls to human resources employee time and attendance information systems. We even see biometrics mixed with cryptography in a multimodal deployment in a South Dakota college for students to identify themselves in order to purchase food items (Kim & Ogbanufe, 2015). What we don't see, however, is a widespread and near-universal adoption and acceptance of this cost effective and useful technology for information systems control purposes. This paper seeks to address the structural reasons that may explain why such a promising information systems security technology has not yet lived up to its hype in real world deployments.

This paper brings five points to the biometrics IS security and control dialog. First, we briefly review the biometric technologies, their effectiveness and tradeoffs from applications of identification vs. verification, while discussing the impact of these topics on issues related to IS controls. Second, the research evaluates the current status of the biometric market in terms of vendor marketing, product development and issues related to the effectiveness and performance of these technologies. Third, we discuss the profound limitations that continue to exist in the biometrics identification and verification security market, using an economic model to suggest lessons for industry, government and private consumers. Fourth, we explore that model using a preliminary analysis of business publication data allowing us to consider our hypotheses regarding the broader issues associated with the use of biometrics for IS security purposes. Lastly, the implications of the model for the IS security domain will be discussed, along with practical recommendations given for the IS manager to consider when evaluating the use of biometrics for information systems control purposes.

Today's biometrics offer technologies that enable the IS security practitioner to deploy strong physical controls to protect various internal and external organizational assets from threats, particularly financial and systems in nature, by constructing accurate, distributed networks of personal identification and verification. In terms of the realization of the benefits of the use of biometrics as a potential security control, the question becomes, "When will we see biometrics become a mainstream control, used daily?" Here, we suggest that IS security managers could benefit from exploiting the solid potential of biometrics to protect against failures of authentication and identification, while avoiding the ongoing biometric market dysfunction that continues to limit vendor successes and market clarity. We are not there yet with the use of biometric controls for IS security problems, but ongoing security identity problems suggest that this tool would be useful when deployed in certain situations for systems security. Why are biometric technologies not a go to, mainstream choice in the security technologist's toolkit at the present time.

## 2. LITERATURE REVIEW

### A REVIEW OF THE BIOMETRIC TECHNOLOGIES

---

<sup>1</sup> Sakarya University, Department of Management Information Systems, 54187, Serdivan, Sakarya, Turkey. [ngugur@sakarya.edu.tr](mailto:ngugur@sakarya.edu.tr)

<sup>2</sup> Sakarya University, Department of Business, 54187, Serdivan, Sakarya, Turkey. [mturkmen@sakarya.edu.tr](mailto:mturkmen@sakarya.edu.tr)

Biometrics are a collection of related IS security technologies that digitize our unique human physiological or behavioral characteristics and use these digital representations of our characteristics to determine or verify identity by comparing a captured sample of an individual to an established database of individual digitized representations. Biometrics can be used in IS security to establish online trust by providing assurance that an individual is who they say they are, even if they are at a distant location, are not in view, and no one can vouch for them (Kleist, 2007). Like most multimodal solutions, when combined with other, more traditional IS security technologies such as a PIN number or digital token, the biometric provides strong identification and authentication properties for systems.

### **Fingerprint**

We are the most familiar with the finger-scan or fingerprint biometrics, related to the history of use for identification and criminal detection purposes. There are many approaches to fingerprint biometrics, but each vendor follows approximately the same system for identifying individuals. Each of us has a unique pattern to our fingerprint based on the whorls, loops and arches in the ridges of the pads of one's fingers. Fingerprint systems are a proven technology, are capable of being used in large-scale systems, and are no longer expensive to deploy in private settings. Today's fingerprint biometric technology typically uses a template that represents a digital representation of an actual print, based on the minutiae. The most likely applications for the fingerprint biometric in IS security applications are in interior environments, where the product can be seamlessly integrated into familiar processes such as a laptop sign on procedure (Morosan, 2010). Fingerprint biometric technology prices are well within the range of delivering quantifiable cost benefit results.

### **Facial Scan**

Facial scan biometrics use unique facial characteristics in order to make a match to an algorithmically determined representation of an abstraction of the stored, digitized image of a face (John D. Woodward, Orleans et al. 2003). Facial scanning works using two fundamental approaches. The first type of facial scan is one where the subject is potentially matched to a stored identity via a controlled capture and the second occurs with a potential match based upon a random group member capture (Kleist, 2007). The controlled capture takes place in an environment where the user identifies themselves to the system. The identification capture is useful for law enforcement and professionals responsible for high security applications in crowds. Facial scanning may be a less expensive biometric than other technologies, but there also may be weaknesses in facial scanning in terms of false rejects for a variety of reasons, such as facial expression variations, hair changes, or lighting pattern differences (Chirillo 2003).

### **Iris Scan**

In humans, both the left and right irises are uniquely patterned within the same individual and between identical twins. Yet, despite and because of this tremendous variability, the iris-scan biometric may be configured to provide a high degree of accuracy for matching a user to the database of stored user iris scan representations (Kleist, 2007). Unlike fingerprint or hand geometry biometrics, it is likely that the iris is less subject to degradations and changes over long periods, yielding a database that can retain integrity over a longer period of time. The accuracy and stability of the iris scan biometric is therefore one of the few biometrics offering true identification, as compared to verification, capabilities. People tend to have a high resistance to iris scans due to their perceptions of its intrusiveness, as well as the slightly increased complexity of its use when compared to hand or fingerprint technologies (Nanavati, Thieme et al. 2002). People are used to giving their fingerprint, but are much less familiar, and perhaps much less comfortable, with the iris scan, making this IS security choice a little less forgiving as a choice for security for general public applications.

### **Hand Geometry**

Hand geometry, offering practical and real world application success stories for true cost benefit paybacks, has been one of the bestselling devices in the traditional access control market because the technology is easy to use, relatively robust and can be flexibly deployed (Riley and Kleist, 2005). While easy to use, the readers are bulky and may require periodic cleaning to maintain performance levels.

### **Retina Scan**

The retina scan, like the iris scan, provides the possibility of high accuracy for identification, and thus is a technology applicable for high security requirements. The user must cooperate with the reading device to identify unique retinal blood vessel patterns in the back of the eye, making the technology seem to be more intrusive and offensive to the general public. The technology identifies up to 192 reference points, resulting in a 96 byte template and is suitable when false rejects are a preferable outcome to an imposter entering the system (Nanavati, Thieme et al. 2002; John D. Woodward, Orleans et al. 2003). Given the high number of unique data points that can be collected with retinal scans, the retinal scan is therefore a difficult technology to spoof.

### **Other Biometrics**

Individuals are unique with respect to the physical arrangement of our vocal cords, vocal tract, palate, teeth, sinuses and mouth tissue, giving us unique and identifiable speech patterns, making voice scanning identification a non-intrusive IS security option. Voice scanning can be highly accurate for authentication (Chirillo 2003). Some banks use signature scanning to analyze not only the appearance of the signature but also the writing dynamics associated with creating the attribute such as writing speed, implement pressure and other similar attributes. Because of the dynamic nature of signature, multiple samples are necessary to capture this biometric. Some of the other biometric technologies that are currently available or in the development stages include keystroke-scanning dynamics, biometrics that examine odor, skeleton, or ear shape (Jain, Bolle et al. 1999).



### 3. CURRENT STATUS OF THE BIOMETRIC MARKET

The market for biometrics is a complex one. In general, biometrics devices, just as with all small electronics, are becoming faster, cheaper and more widely accessible (Tilton 2003). It ranges from small vendors with a new technologies operating in startup mode to large, well-established and well-recognized vendors that have been in this marketplace for decades, selling traditional fingerprint or hand geometry reader technology to governments all over the world. Other vendors may manufacture a single biometric or several; some vendors generate revenue by licensing proprietary software used by other vendors in their products; selling an upstream product in the vertical channel instead of selling a customer product in horizontal markets (Soh, et al., 2010). Other biometrics industry vendors are known as systems aggregators, solving large security problems by analyzing, recommending, selecting and installing many security solutions from many different vendors for their customers, where biometrics are but one subset of their arsenal of consulting solutions. Data suggests that the fingerprint biometric is the strongest right now, and may still be in a dominant position in five years. Multimodal biometric deployments are a clear trend embraced by both vendors and buyers.

A review of 3 years of Wall Street Journal articles related to biometrics indicates that the private sector market is led by usage in grocery stores and financial institutions. The medical market is not captured by any single technology at this time, but represents the next big opportunity for vendors in the private sector, after the financial institutions and credit card applications. This expansion in the private sector for biometrics technology was one of the most exciting developments uncovered in the research. In general, it can be stated that most biometric technologies have not coalesced around any dominant standards, limiting the momentum that might occur if vendors were to agree upon algorithms or data standards.

### 4. ECONOMIC MODEL OF THE BIOMETRIC INDUSTRY AND MARKET RESEARCH

When considering the adoption of a biometric, IS security personnel must consider more than the fit of the technology to the business problem of the biometric. No one biometric leads or dominates, nor does any single vendor dominate in the industry. As Arthur indicates, one technology product may lead in market share for a time and then another product may lead for a time (Arthur, 1989, 1994). Part of the lack of usage of biometrics by IS security managers may relate to the idea that they are deciding upon a biometric product before the “tipping point” of that biometric has been reached. System managers prefer to choose a technology that is the clear leader, such as fingerprint or facial scanning (Venkatraman & Delpachitra, 2008). Yet, in the biometrics industry, it can be argued that there is no single firm or biometric type that has achieved a dominant market share role of sufficient size and strength as to allay corporate fears of technological obsolescence or firm failure. It can be argued that IS security managers are selecting a technology before it is clear which of these many technologies and vendors will come to dominate in the market. This insecurity may be underlying the lack of usage of biometrics as a key security solution and tool in security control implementations.

A total of 182 articles were read for the periodical analysis portion of the research. Over 90 articles were read from the Wall Street Journal database, 68 articles from the EBSCO host database and 19 out of 24 articles from the LexisNexis database contributed to the analysis, representing various other periodicals, having done a computerized search on the biometrics industry. Following interviews with vendors and a content analysis of top business periodicals for a three year period, we uncovered the following results, preliminarily: Up until now, the strongest markets for biometrics technologies have only been realized in governmental applications across the world. Usage in welfare systems, census projects, jails, access to military bases and other applications are well documented.

- Potential applications for business customers of biometrics might be to use biometrics to ensure that transactions are accomplished with accuracy and security in external relationships with suppliers or retailers.
- Potential applications for systems security managers might also be in ensuring the accuracy and timeliness of payments for their own employees. Internal business applications might be in help desk password resets, in entry access monitoring, in employee time and attendance situations and for simple applications such as cafeteria payment mechanisms. Internal deployments with employees are likely an easier place to start with biometric security solutions than external deployments with customers.
- Large e-commerce businesses such as Amazon and EBay have problems with fraud and theft in the retail channel. Biometrics payment mechanisms in electronic commerce, such as fingerprint readers at laptop keyboards, may help businesses to avoid some of the weaknesses of credit card payment fraud.
- Examples of non-governmental applications reported in the Wall Street Journal that are striking include the use of fingerprints for payroll check processing at 176 Bi Lo stores, Piggly Wiggly is looking at the technology for 120 stores, Blockbuster and Kroger are also evaluating this technology. BioPay LLC of Herndon VA has signed up 500 merchants for payment technology that uses customers' fingerprints for payment. The Pay by Touch system uses a fingerprint combined with an 8 or 10 digit pin to identify customers and link them to a back office electronic wallet holding a payment mechanism. Discover Financial, a subsidiary of Morgan Stanley, is associated with this approach of using an e-wallet, although it will accept more than the Discover card at payment locations. These reported applications are examples of how biometrics are moving into the financial sector, check cashing, and credit card replacement areas.
- Businesses, apartments, dormitories, office spaces and homes all share the commonality of repetitive key management tasks; issuing, monitoring and changing physical locks and keys whenever appropriate. It may be that biometrics have reached the cost effective threshold where these devices can compete in price against more old fashioned key management approaches.
- Testing labs give independent assessments of various technologies. As a buyer, it would be prudent to insist on an independent assessment of performance criteria. It would also be prudent to follow traditional systems analysis design principles, which

includes thinking about a pilot test or departmental trial attempt before unveiling a major installation. As in any large technology purchase, requests for proposal are helpful and visits to other satisfied customers useful.

- There are examples of the positive cash flows from the implementation of biometrics in password reset applications, for time and attendance situations and for security enhancement applications. As prices fall, these positive net cash flows from biometrics will be more likely to be available. Further, cost savings from biometrics may be more likely to be found in the more mundane, operational level applications rather than the exotic, flashy or exciting kinds of biometric installations. Do not overlook routine and ordinary applications in the exploration of biometric technology for an organization.

- Multimodal applications have increased in popularity. A buyer might wish to investigate pairing two biometrics together or a biometric with another security solution.

- In a governmental biometric deployment, we found a positive cash flow over a five year view for the use of a hand geometry system used for access to a secure location used daily by 10,000 users. In an independent audit, we determined that the significance of this biometric deployment was the hand geometry biometrics installation provided a "best practice" that dramatically increased overall security for relatively low one time and recurring costs.

- Our research found that government buyers with very high security concerns for personnel and property might be more concerned with the effectiveness of the solutions and scalability of the product over the cost. We also found that buyers with less concern over security may have more interest in the relevance of the cost, but we were unable to make any definitive conclusions due to lack of data.

## 5.CONCLUSION

Biometric technologies promise to enhance many systems with more convenience and have the potential to also provide better privacy and higher security. While the field is developing rapidly, it can be difficult to identify the real advantages and disadvantages associated with the use of biometry. As biometric technology matures, there will be increasing interaction among the market, the technologies, and the applications. This interaction will be influenced by the additional value of the technology, user acceptance, and the credibility of the service provider. To conclude, we reviewed biometrics as a possible highly effective IS control solution, yet considered that this solution has been largely overlooked and ignored by IT managers. Yet, we argue here that it is possible to deploy biometrics to offer significant benefits for IS security problems while successfully mitigating the negative aspects of the technology and its turbulent markets.

## REFERENCES

- [1]. W. B. Arthur, "Competing Technologies, Increasing Returns, And Lock-In By Historical Events," *The Economic Journal*, 99(394), 116-131, 1989
- [2]. W. B. Arthur, *Increasing Returns And Path Dependence In The Economy*, University of Michigan Press, 1994.
- [3]. J. Chirillo, *Hack Attacks Testing: How To Conduct Your Own Security Audit*, John Wiley & Sons, 2003.
- [4]. A. K. Jain, R. Bolle and S.Pankanti, *Biometrics: Personal Identification In Networked Society*, 1999.
- [5]. D. Kim, and O.Ogbanufe, *Beyond Security and Privacy Perception: An Approach to Biometric Authentication Perception Chang*, 2015.
- [6]. V. F. Kleist, "Building Technologically Based Online Trust: Can The Biometrics Industry Deliver The Online Trust Silver Bullet?," *Information Systems Management*, 24(4), 319-329, 2007.
- [7]. C. Morosan, "Theoretical And Empirical Considerations Of Guests' Perceptions Of Biometric Systems In Hotels: Extending The Technology Acceptance Model." *Journal of Hospitality & Tourism Research*, (2010: 1096348010380601.
- [8]. S., Nanavati, M., Thieme and R. Nanavati, *Biometrics: Security Verification in a Networked World*, 2002.
- [9]. Riley Jr, R. A., & Franke Kleist, V. (2005). The biometric technologies business case: a systematic approach. *Information management & computer security*,13(2), 89-105.
- [10]. K. L., Soh, W., Wong and K. L. Chan, "Adoption Of Biometric Technology In Online Applications," *International Journal of Business and Management Science*, 3(2), 121. (2010).
- [11]. C. J. Tilton, *White Paper: Biometric Industry Standards*, SAFLINK Corporation, 2003.
- [12]. S., Venkatraman and I.Delpachitra, "Biometrics In Banking Security: A Case Study," *Information Management & Computer Security*, 16(4), 415-430, 2008.
- [13]. J. D., Woodward, N. M., Orlans and P. T. Higgins, *Biometrics:[Identity Assurance In The Information Age]*. New York: McGraw-Hill/Osborne, 2003.

# Potential Mistakes Made in Design of Natural Wastewater Treatment Systems (Constructed Wetlands)

Zeki Gokalp<sup>1</sup>, Sedat Karaman<sup>2</sup>, Belgin Cakmak<sup>3</sup>

---

## Abstract

Current climate change and resultant global warming have exerted a great pressure over water resources. Water resources are not sufficient in some countries to meet ever-increasing domestic, agricultural and industrial demands. Such restrictions oriented countries either to use water-saving technologies or to reuse treated wastewaters. Besides conventional, high-cost advanced treatments systems, natural treatment systems are used in small communities. Constructed wetlands, so called as natural treatment systems, emulates the natural wetlands and uses the biochemical processes taking place in natural one to remove pollutants from wastewaters. They are commonly preferred in rural sections, especially for wastewater treatment in villages. Although these systems are quite new in Turkey, there are several of them constructed in various parts of the country. Since several mistakes have been made in design of these systems, majority of them either not operating at all or way behind the expected performance outcomes. Once these systems were constructed, it is quite hard to make repairs or rehabilitation to improve the performance of these systems. Therefore, design criteria should strictly be taken into consideration before to construct natural treatment systems. The present study was conducted initially to point out the design criteria for constructed wetlands and then to put forth possible mistakes made in design, operation and maintenance of these systems. Recommendations were also provided for future constructions.

**Keywords:** Wastewater, natural treatment, constructed wetlands, Turkey

---

## 1. INTRODUCTION

World population today already reached to 7.5 billion and there is an ever-growing demand for food and water resources to feed this huge and continuously increasing population. There is an increasing pressure exerted over available water resources since agricultural, industrial and domestic water users are in a challenging competition for limited fresh water resources. Besides, current global warming and climate change aggravate this pressure over water resources. Thus, world countries have put water resources and water-related problems into the first place in their agendas and assigned uppermost significance to water resources. Agriculture is the greatest water user sector especially in developing countries. Therefore, initially agricultural water use should be handled to overcome water-related problems; then the problems in other water using sectors should be taken into consideration. Water losses and wastes in all sectors should be prevented, efficient water use should be provided and possible use of wastewater and treated water should be investigated [1].

According to the results of Municipal Wastewater Statistics Survey, which was applied to all municipalities, 1,309 out of 1,396 municipalities were served by sewerage systems in 2014 in Turkey. Out of 4.3 billion m<sup>3</sup> of wastewater collected by sewerage systems, 44.6% was discharged into sea, 44.2% was discharged into river, 2.8% into dam, 2.2% into lake and artificial lake, 0.4% onto land, and 5.8% to other receiving bodies. Out of 4.3 billion m<sup>3</sup> of wastewater discharged via sewerage system, 3.5 billion m<sup>3</sup> was treated in wastewater treatment plants. It means treatment was applied to 81% of discharged wastewater. The rate of advanced treatment was 41.6%, while the rate of biological treatment was 33.2%, the rate of physical treatment was 25.0% and the rate of natural treatment was 0.2%. Rate of population served by wastewater treatment plants was 64% in Turkey's population, and 68% in total municipal population. Average amount of wastewater discharged from municipal sewerage systems per capita per day was calculated as 181 liters [2].

Constructed wetlands, also called natural treatment systems with their cheaper and easy construction, low energy and labor costs, easy operation, maintenance and monitoring were specified as the primary issue in rural development strategy document of State Planning Organization of Turkey (Anonymous, 2006). Natural and constructed wetlands are treatment systems employed as an alternative to conventional treatment systems because of their low construction, operation and maintenance costs, low energy demands, simple operation and low sludge generation [3, 4]. These systems are specially designed systems

---

<sup>1</sup>Corresponding author: Erciyes University, Agricultural Faculty, Department of Biosystems Engineering, 38039, Melikgazi/Kayseri, Turkey.  
[zekigokalp@yahoo.com](mailto:zekigokalp@yahoo.com)

<sup>2</sup>Gaziosmanpasa University, Agricultural Faculty, Department of Biosystems Engineering, 38039, Tasliciftlik/Tokat, Turkey.  
[skaraman@gop.edu.tr](mailto:skaraman@gop.edu.tr)

<sup>3</sup>Ankara University, Agricultural Faculty, Department of Agricultural Structures and Irrigation, 06360, Dışkapı/Ankara, Turkey.  
[Belgin.Cakmak@agri.ankar.edu.tr](mailto:Belgin.Cakmak@agri.ankar.edu.tr)

imitating the natural wetlands and include soil, plant and microorganisms to remove the pollutants from wastewaters. An excavated constructed wetland basin is lined with compacted clay or synthetic membrane and filled with graded sand-gravel substrate [5]. Today, constructed wetlands are widely used to treat domestic wastewaters, agricultural wastewaters, industrial wastewater and runoff waters. Treated effluent water can be used for irrigation and other water recycling purposes.

In present study, initially brief information was provided about the natural wetlands to present an insight into natural treatment systems. Then, possible use of constructed wetlands imitating these natural wetlands for waste water treatment in rural parts of Turkey, especially in villages, was assessed. Brief information was also provided about potential drawbacks and problems observed in construction, operation and maintenance of these systems.

## 2. NATURAL WETLANDS

A wetland is a land area that is saturated with water, either permanently or seasonally, such that it takes on the characteristics of a distinct ecosystem [6]. The primary factor that distinguishes wetlands from other land forms or water bodies is the characteristic vegetation of aquatic plants, adapted to the unique hydric soil. According to Ramsar Convention, wetlands include a wide variety of habitats such as marshes, peatlands, floodplains, rivers and lakes, and coastal areas such as saltmarshes, mangroves, and seagrass beds, but also coral reefs and other marine areas no deeper than six meters at low tide, as well as human-made wetlands such as waste-water treatment ponds and reservoirs [7].

Wetlands have various significant roles in environment such as water purification, flood control, carbon sink and shoreline stability. They are also considered as the most biologically diverse of all ecosystems and serve as home for a wide range of plant and animal species. Nutrient inflow to wetlands supports the growth of vegetation and vegetation constitutes the primary component of wetland food-chain and converts inorganic materials into organic materials [8]. The functions and benefits provided by the wetlands can be summarized as follows [9]:

- Purify waters through retaining residues and poisonous materials or using nutrients (nitrogen, phosphorus).
- Raise the humidity of the region where they are located and have positive impacts primarily on local climate parameters such as precipitation and temperature.
- Stabilize the water regimes of the regions where they are located through charging or discharging groundwater tables, storing floodwater, controlling floods, preventing sea water intrusion.
- Provide a habitat for a rich flora and fauna.
- They have a high economic value with their supports provided in fishery, agriculture, livestock, reed production and tourism.

Just because of wastewater discharges into wetlands because of water treatment functions, they are under serious pollution threats and such a case brought the preservation of such sites into consideration. Although researches indicated high waste water treatment performance of natural wetlands, such implementations may have some adverse effects with regard to preservation of these sites. Toxic elements in wastewaters, negative impacts of pathogens and additional hydraulic loading and nutrients can cause long-term degradations in these natural systems. Therefore, constructed wetland technologies have been developed instead of natural ones for wastewater treatment purposes.

## 3. NATURAL TREATMENT SYSTEMS (CONSTRUCTED WETLANDS)

Many terms are used to denote constructed wetlands, such as reed beds, soil infiltration beds, constructed treatment wetlands, treatment wetlands, etc. Beside "engineered" wetlands, the terms of "man-made" or "artificial" wetlands are often found as well [10]. Constructed wetlands imitate the natural wetlands in treatment of domestic wastewaters. They are also called natural treatment systems and contain soil, plant and microorganisms within specially-designed and constructed basins to remove pollutants from wastewaters [11]. These systems are commonly composed of a compacted clay or synthetic liner overlaid with graded sand and gravel substrate material, reed like aquatic plants and the other engineering structures adjusting hydraulic loading rates, hydraulic retention times and water levels within the basin (Fig. 1). Constructed wetlands are engineered systems that use natural functions of vegetation, soil, and organisms to treat different water streams. Depending on the type of wastewater that has to be treated the system has to be adjusted accordingly which means that pre- or post-treatments might be necessary. Constructed wetlands have several advantages over the conventional treatment systems. The primary advantage is their low costs and easy construction. They require quite low or even zero-energy for operation and have significantly lower operational costs than the conventional ones. Constructed wetlands are environment-friendly systems and provide habitat for various wetland plants and organisms. Beside these advantages, they have also some disadvantages. They require larger construction areas than regular and conventional treatment systems to treat the same capacity wastewater influent. The system performance is less stable, dominantly depend on wastewater characteristics and can easily be altered by changing climate conditions. A successful constructed wetland design should take the following general criteria into consideration [12]:

- The design should comply with the natural landscape and topography.
- The design should be kept as simple as possible.
- Extreme weather and climate conditions should be considered in design.
- The design should be so performed as to require the least maintenance.
- The wastewater flow should be supplied through gravitational flow.
- The systems should be allowed time to reach the desired performance values.

Constructed wetlands are commonly designed as surface flow and sub-surface flow constructed wetlands. Based on flow regime, sub-surface flow wetlands are also classified as vertical and horizontal flow constructed wetlands. In Turkey, mostly sub-surface horizontal flow constructed wetland systems are used for domestic wastewater treatment in rural sections of the country.

### 3.1. Surface Flow Constructed Wetlands

Surface flow constructed wetland systems are composed of a natural or excavated bed or canal, a compacted impervious layer at the bottom, soil or another substrate media for plant rooting and relatively low water level flowing through the system (Fig. 2). Some design parameters are provided in Table 1. Water surface is open to atmosphere and above the filtrate or substrate material. These systems look more like the natural wetlands and provide various benefits for wild life beside water treatment [13]. The primary advantage of these systems are their low investment, operation and maintenance costs, easy construction and operation and the basic disadvantage is the land requirement to construct such systems since they require significantly larger areas than the other constructed wetland or conventional treatment systems [14].

Table 1. Design parameters for surface flow constructed wetlands

Parameter	Design Criteria
Influent quality	BOD $\leq 20 - 30 \text{ mg L}^{-1}$ TSS $\leq 20 - 30 \text{ mg L}^{-1}$
Pre-treatment	Oxidation basins
Design flows	$Q_{\max}$ (maximum monthly flow) $Q_{\text{ave}}$ (average flow)
Maximum BOD loading	$20 \text{ mg L}^{-1} : 45 \text{ kg ha}^{-1} \text{ day}^{-1}$ $30 \text{ mg L}^{-1} : 50 \text{ kg/ha}^{-1} \text{ day}^{-1}$
Maximum TSS loading	$20 \text{ mg L}^{-1} : 45 \text{ kg ha}^{-1} \text{ day}^{-1}$ $30 \text{ mg L}^{-1} : 50 \text{ kg ha}^{-1} \text{ day}^{-1}$
Water depth	0.6 – 0.9 m (full plant cover sections) 1.2 – 1.5 m (Open water surfaces)
Maximum HRT	1.0 m (Inlet settling section) 2 days (full plant cover sections) 2 – 3 days (Open water surfaces)
Basin geometry	Optimum 3:1 – 5:1
Inlet settling section	In case of failed pretreatment in settling
Inlet	Uniform influent distribution in inlet
Outlet	Uniform effluent collection in outlet

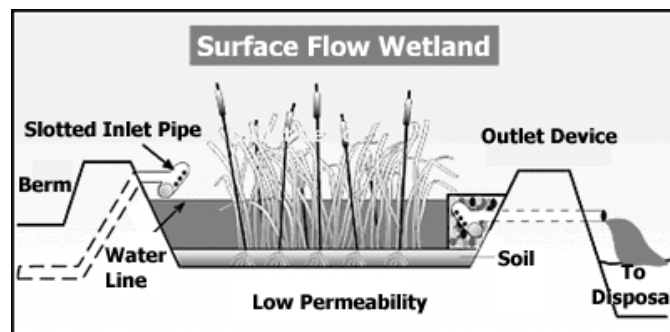

Figure 2. Surface flow constructed wetlands [15]

### 3.2. Sub-surface Flow Constructed Wetlands

Water does not come out to surface in sub-surface flow constructed wetland systems, water level is not open to atmosphere and flows through a substrate material and reaches to outlet. Sub-surface flow constructed wetlands are usually composed of an excavated basin, a compacted clay or synthetic impermeable liner overlaid by graded gravel and sand substrate material planted with aquatic plants and water level control structures (Fig. 3). Based on flow regime, they are designed in either horizontal flow or vertical flow and can be used with and without emergent plants [16]. Certain parameters should be taken into consideration in design of these systems and recommended design criteria are provided in Table 2 [14]. Sub-surface horizontal flow constructed wetlands are used for domestic wastewater treatment in rural parts, especially in villages of Turkey. Municipal waste water administrations or special provincial administrations are responsible for the construction of these systems. However, most of them have already been constructed by special provincial administrations. The administrations usually use type-projects designed to serve certain populations. Since these systems are constructed in villages, they are commonly designed for 250, 500, 750 and 1000 people. A type project designed for a population of 750 people is presented in Fig 4. Concrete septic tanks (usually with 4 cells) are constructed in front of constructed wetland systems to provide a pre-treatment for influent. Suspended soils are mostly settled in septic tanks. Some design parameters are provided in Table 2.

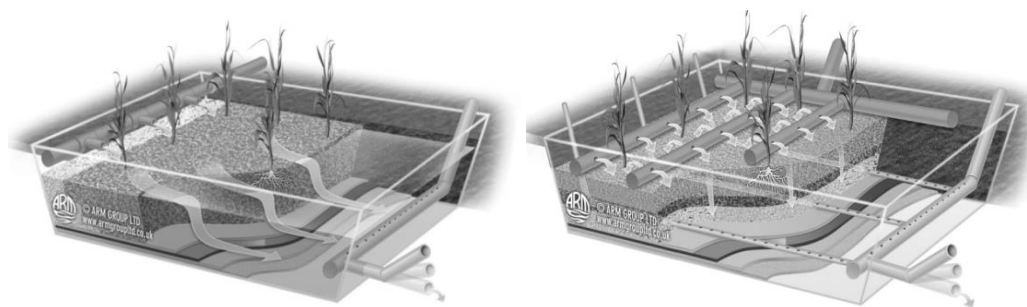

Figure 3. Horizontal and vertical flow sub-surface constructed wetlands [17]

Table 2. Design parameters for sub-surface flow constructed wetlands

Parameter	Design Criteria
BOD	6 g m <sup>-2</sup> day <sup>-1</sup> – 30 mg L <sup>-1</sup> for inlet
TSS	20 g m <sup>-2</sup> day <sup>-1</sup> – 30 mg L <sup>-1</sup> for inlet
Depth	Substrate: 0.5-0.6 m Water 0.4-0.5 m
Length	Minimum 15 m
Width	Maximum 61 m
Bed bottom slope	0.5 – 1%
Bed surface slope	Flat or almost flat
Hydraulic conductivity	1000 m day <sup>-1</sup> for the first 30% of length 10000 m day <sup>-1</sup> for the last 70% of length
Substrate	Inlet section: 40-80 mm Process section: 20-30 mm Outlet section: 40-80 mm Planting section: 5-20 mm

About 1.0 m deep basin is excavated with construction machinery just by taking the population into consideration. Usually about 1 m<sup>2</sup> base area was considered for each person. An aspect ratio (L:W) of about 5:1 is generally used in sub-surface flow constructed wetland systems in Turkey. Excavation of slopes usually performed at a ratio of 1H:2V. Once the basin was excavated, about 10 cm clay liner is placed over the bottom and slopes and the liner is then compacted. Instead of using geotextile or synthetic liners, compacted clay is generally used in Turkey to provide bottom lining and to prevent possible seepage through the bottom and slopes.

The most significant component of these systems is the substrate material filtering the wastewater. The material both provides a medium for rooting of aquatic plants and distributes influent, directs and collects effluent, provides surface area for microbial activity and filters suspended solids. Although various size and composition of substrate materials have been tried, there are not any concrete evidences about which size or type of material is the best. The basic criterion is not to allow small particles settle into the pores of coarser ones. About 15 cm agricultural soil is placed over the clay liner for rooting of aquatic plants to be planted later on. Over the soil, about 25-30 cm medium gravel (1.0-1.5 cm diameter) layer is placed and over that layer, about 20 cm sand (2.0 mm) layer is placed. Substrate upper surface is leveled and about 1% slope is provided at bottom surface. Coarse gravel (4.0-6.0 cm diameter) is placed at the influent entrance and effluent outlet sections to provide easy influent flow into substrate material through the perforated pipe placed around the top of coarse gravel and easy discharge of effluent through perforated drainage pipe placed beneath the coarse gravel.

Side berms are slightly elevated from the substrate surface to prevent runoffs and erosion of fine materials into the reed bed. Usually common reed (*phragmites australis*) is used for surface plantation of constructed wetlands in Turkey. A usual density is taken as 3-5 plants (rhizomes) per square meter. Finally entire reed bed is surrounded with wire-mesh fences to prevent access to reed bed. The system is then handed over to local administration (village administration) for operation.

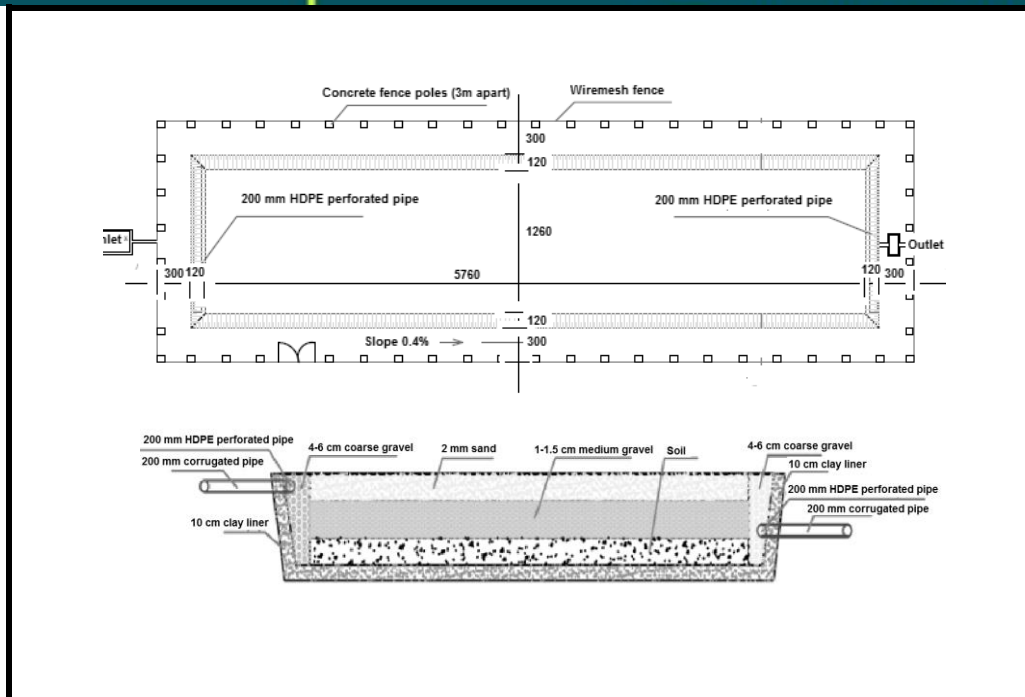

Figure 4. A pilot project designed for a population of 500 people

#### 4.COMMON PROBLEMS EXPERIENCED IN CONSTRUCTED WETLANDS

In Turkey, only the population to be served was taken into consideration while designing horizontal flow sub-surface constructed wetlands. Local topography, climate conditions, influent wastewater characteristics, hydraulic loading rates, hydraulic retention times, site-specific characteristics, discharge criteria and most important of all standard design procedures are not taken into consideration. Thus, various failures are experienced because of such design errors and majority of already constructed systems are not either well-operating or not-operating at all [18].

The common failures are classified as:

- Mistakes made in design of natural treatment systems,
- Failures in site selection,
- Inlet clogging,
- Substrate clogging,
- Water ponding over the surface,
- Outlet clogging,
- Leakage through slopes,
- Plantation failures,
- Failures in operation and maintenance [19].

The most critical mistake made in design of constructed wetlands is observed in required basin area. Design manuals recommend 5 m<sup>2</sup> basin surface area per capita or at least 3-5 m<sup>2</sup> in case of limited land resource [14]. However, the systems constructed in Turkey usually allocate about 1 m<sup>2</sup> basin surface area per capita. That is to say, trying to treat wastewater influence of a single person with 5 times less basin area or substrate material. The ultimate outcome will definitely be a fiasco. The substrate material will not be able to bear that much influent and will either clog instantly or allow water ponding throughout the basin surface.

The suitability of a site for constructing a treatment wetland may depend on the condition of one or more of the following factors: substrate, soil chemistry, hydrology/geomorphology, vegetation, presence of endangered species or critical habitat, wildlife, cultural/socioeconomic impacts including environmental justice issues, the surrounding landscape, land use/zoning considerations, and potential impacts to safety and health, such as impacts from major flooding events and vector-borne disease. Project proponents and permit applicants should carefully examine these factors and consult with applicable agencies in determining the most appropriate site(s) for their projects, and should follow the necessary environmental impact review procedures or other requirements in selecting the final project location and characteristics. A failure case for site selection is presented in Fig. 5a. Natural treatment system was directly constructed by a small creek. Substrate was already washed out and wetland just turned into a little swamp. Influent water is directly passing through above the wetland surface and discharged into adjacent creek without almost any treatment.

By far the biggest operational problem of constructed wetlands nowadays is clogging of the filter beds. The term "substrate clogging" summarizes several processes which lead to a reduction of the infiltration capacity of the substrate surface. Substrate clogging leads to an extremely fast failure of the treatment performance of the system. To run constructed wetlands at high

loading rates without running into clogging problems in a long term view can therefore be considered as one of the most prominent research and development goals in constructed wetland technology. Filtrate clogging is the most common failure case observed in constructed wetlands of Turkey. Fig. 5b illustrates the results of a clogged inlet zone. Sewage from septic tank was pounded just in front of the coarser inlet section and pounding expended throughout the substrate surface. A clogged outlet zone is presented in Fig. 5c. Partially treated domestic wastewater was pounded just over the outlet zone.

Well-grown and sustainable plantation is a crucial issue for proper treatment through constructed wetlands. Establishing vegetation in a constructed wetland involves planting a suitable propagule at appropriate time. Whole plants or rhizomes are used in a typical plantation. A failure case for plantation is presented in Fig. 5d. Common Reed (*Phragmites* spp.) was used in investigated constructed wetlands since this is the most common plant used in Europe and in countries with a cold climate. A planting density of 5 rhizomes  $m^{-2}$  was implemented. A homogeneous and well-grown plantation was able to be observed in only a few of the investigated natural treatment systems. Plantation was either fully or partially unsuccessful in many of the treatment systems in Turkey. That does not mean the rest are successful in plantation. Most of them have somehow different problems with regard to planting. Several of them just turned into weed beds instead of turning into a well-grown reed beds. So, the researchers of present study called them “weed bed rather than reed bed”.

vious liner and to prevent leakage from the bottom and slopes of the wetland basins. Instead of such synthetic liners, compacted clay liner was used over the bottom and slopes of constructed wetlands of Turkey. Since a synthetic liner was not used and slopes were not able to be compacted properly, leakage was observed in some villages through the slopes of basins. Leaking effluent is directly spilled over the adjacent fields and reaches to the nearest creeks.

A proper operation, monitoring and maintenance program is the key issue to achieve the desired performance parameters from a natural treatment system. Proper design is not sufficient alone to have the required performance. Constructed wetland systems require infrequent operation and maintenance activities to achieve the performance goals if they are designed and constructed properly. The most critical items in which operator intervention is necessary were specified as below:

- Maintenance of flow uniformity
- Management of vegetation
- Maintenance of slopes

Routine monitoring is essential in managing a wetland system. In addition to regulatory requirements, inflow and outflow rates, water quality, water levels and indicators of biological conditions should be regularly monitored and evaluated. There aren't any operation, monitoring and maintenance plans and activities in most of the constructed wetlands of Turkey. State authorities have proposed to construct natural treatment systems to villages with sewage systems and required a land allocation from the villages desired to own a treatment system. A tender is usually held for the construction works for the implementation of a pilot project based on the village population. The contractor implements the pilot project and hand it over to village judicial personality. Nothing was done after the hand-over of these facilities with regard to operation, monitoring and maintenance of natural treatment systems. Everything was left as it was constructed. Current observations revealed that almost all of them should pass through rapid maintenance and monitoring processes.

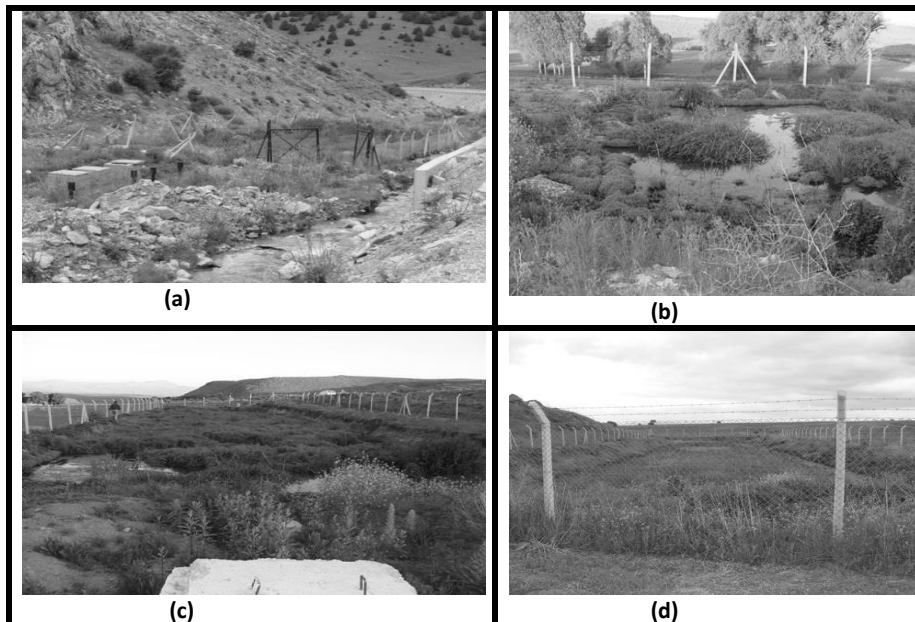

Figure 5. Common failures experienced in practice [19]



**5.CONCLUSIONS**

As long as appropriate design criteria were taken into consideration, constructed wetlands, also called natural treatment systems, can reliably be implemented in sites with low land costs and limited labor force. These systems, especially sub-surface horizontal flow constructed wetland systems, are getting common in rural parts of Turkey, especially in villages to treat domestic wastewater. Such implementations were also specified as the primary issue in rural development strategy document of State Planning Organization of Turkey. However, most of the already constructed systems are not either well-operating or not operating at all just because of errors and mistakes made in their design, operation and maintenance processes. Such errors must urgently be corrected to prevent the waste of investment made on these systems. Valid design specifications, site-specific conditions, local climate conditions and extreme values, influent wastewater characteristics, hydraulic loading rates and retention times should all be taken into consideration while designing a natural treatment system for a specific location. As to conclude, constructed wetlands are the significant systems to prevent water resources pollution since the wastewater previously was being discharged into receiving bodies without any treatments. Now, treated effluents are discharged into water bodies with these systems and consequently both water quality and aquatic life are preserved against the toxic and hazardous impacts of untreated sewage.

**REFERENCES**

- [1] T. Akuzum, B. Cakmak, Z. Gokalp, Türkiye'de su kaynakları yönetiminin değerlendirilmesi, *1. Ulusal Su Kaynakları Yönetimi Sempozyumu*, 20-22 Ekim, Karaman, 2010. (in Turkish).
- [2] Anonymous, Municipal Waste Water Statistics 2014, *Turkish Statistical Institute*, No:18778, 22 December 2015.
- [3] R.L. Knight, T.W. McKim, H.R. Kohl, . Performance of a natural wetland treatment system for wastewater management. *J. Water Pollut. Control Fed.* 59, 746-754, 1987.
- [4] H.R. Kadlec and R.L. Knight, *Treatment Wetlands*. Lewis, Boca Raton, New York, London, Tokyo, p. 893, 1996.
- [5] Anonymous 2011a. What are constructed wetlands in Treatment of Agricultural Waste by use of Constructed Reed-bed Wetlands, Available at <http://pgoforth.myweb.uga.edu/page3.html>.
- [6] Anonymous, *Department of Environmental Protection State of Florida Glossary. State of Florida*. Retrived 2011-09- 25, 2011b.
- [7] Anonymous, *Wise Use of Wetlands, Ramsar Handbooks, 4<sup>th</sup> Edition, Handbook 1*, 2011c.
- [8] D.A. Hammer, R.X. Bastian, *Wetlands ecosystems: Natural water purifiers*. In: Hammer, D.A. (Ed.), *Constructed Wetlands for Wastewater Treatment*. Chelsea, Lewis, pp. 5-19, 1989.
- [9] Z. Ayvaz, Doğal Zenginlik Müzeleri Sulak Alanlar, *Ekoloji Magazin*, Nisan-Haziran, Sayı 6, 2005. (in Turkish)
- [10] H. Hoffmann, C. Platzer, E. von Münch, M. Winker, *Technology review of constructed wetlands - Subsurface flow constructed wetlands for greywater and domestic wastewater treatment*. Deutsche Gesellschaft für Internationale Zusammenarbeit (GIZ) GmbH, Eschborn, Germany, 2011.
- [11] EPA, *Constructed wetlands for wastewater treatment and wild life habitat: 17 Case Studies*. EPA832-R-93-005. 1993.
- [12] EPA, *A Handbook of Constructed Wetlands, Volume 1:General Considerations*, USEPA Region III with USDA, NRCS, ISBN 0-16-052999-9, 1995.
- [13] R.B.E. Shutes, M. Revitt, M. Forshaw, B Winter, B, *Constructed Wetland Monitoring and Management for Urban Runoff Management*. In : Editors : Mansor, M., Eng, L.P. and Shutes, R.B.E. *Constructed Wetlands : Design, Management and Education*. Universiti Sains Malaysia Publisher, Malaysia, 2002.
- [14] EPA, *Manual, Constructed Wetlands Treatment of Municipal Wasterwaters*, EPA/625/R-99/010, U.S. Environmental Protection Agency, Cincinnati, Ohio, USA, 1999.
- [15] Anonymous, available at <http://www.wateronline.com/doc/surface-flow-systems-work-like-natural-wetlan-0001>.
- [16] T.C. Young, A.G. Collins and T.L. Theis, *Subsurface flow wetland for wastewater treatment at Minoa, NY*. Report to NYSERDA and USEPA, Clarkson University, NY, 2000.
- [17] Anonymous, available at <http://www.armreedbeds.co.uk/resources/constructed-wetlands/horizontal-subsurface-flow>
- [18] Z. Gokalp, B. Cakmak, "Doğal Arıtma Sistemlerinde Karşılaşılan Problemler ve Çözüm Önerileri", *3. Uluslararası Bursa Su Kongresi*, Cilt 1, s.119-126, 2013 (in Turkish).
- [19] Z. Gokalp, O. Uzun, Y. Cals, *Common Failures of the Natural Treatment Systems (Constructed Wetlands) of Kayseri, Turkey. Ekoloji* 23(92):38-44, 2014.

# Analysis Of Sustainability Reporting in the Turkey Automotive Sector

*Gulcin Yildirim<sup>1</sup>; Tugce Uzun Kocamis<sup>2</sup>; Emine Mukaddes Kistan<sup>3</sup>*

---

## Abstract

*Sustainability reporting is a responsibility practices related to corporate performance measurement for sustainable development objectives. Prepared as a requirement of the responsibility for the internal and external stakeholders. Companies share the non-financial information relating to business activities through sustainability reports. Sustainability reports were developed with GRI Reporting Framework and encompass organization's results in the context of strategy and management approach in a reporting period. A sustainability report is an organizational reports that provide economic, environmental, social and governance information about performance. Implementation of corporate sustainability and sustainability reporting has continued to grow steadily in recent years. This is true for companies in the automotive sector.*

*The automotive sector is considered as the locomotive of the world economy in all industrialized countries due to the significant contribution both employment and the economy in terms of export statistics. With Sustainability Reporting, companies provide significant gains in the area of talent management and supply chain, occupational health and safety at work, with the acquisition of the environmental performance. In this context; the study aims to analyze sustainability reports of the companies operating in the automotive sector in Turkey Istanbul Stock Exchange Sustainability (BIST) Index on the basis of social performance data with TOPSIS method.*

**Keywords:** *Sustainability Reporting, TOPSIS Method, Sustainability Reporting in Automotive Sector*

---

## 1. INTRODUCTION

The adaption of corporate sustainability and sustainability reporting has continued to grow steadily in recent years. This idea based on no healthy society or economy can exist in a world with so much poverty and pollution. Conventional methods of economic and social development has failed to consider the importance of environment. Now the new approach is to meet people's basic requirements while striving to assure the health of the environment and economic prosperity for all people.

The concept of "Sustainable Development", as part of it also "Corporate Social Responsibility", is gaining attraction of companies. Sustainable development seeks to take account of and integrate the economy, ecology and society in order to preserve the world's environmental and cultural resources for future generations while also respecting diversity and reducing social inequality [1]. Society demands more transparency and companies want to and must communicate about their sustainability performance. This concept also contains the economic survival of companies [2].

The challenges surrounding issues of sustainability and its implementation are strongly felt in the automotive sector. The automotive sector faces the following challenges: intensifying competition, increasing importance of corporate sustainability and corporate social responsibility (CSR), more discerning customers rising costs of raw materials, tighter regulations (e.g., concerning CO<sub>2</sub> emissions), greenwashing, and maintaining reputation. As these challenges show, sustainability plays an important role in the automotive sector today[3]. It is a clear need for company action, and at the same time, there is also wide recognition that sustainability offers considerable potential.

In our study, the relationship between the concept of sustainability and automotive sector was explained. The reports of the automotive companies are located in the Sustainability Index in BIST were analyzed with TOPSIS method.

## 2. RELATIONSHIP BETWEEN SUSTAINABILITY AND AUTOMOTIVE SECTOR

A sustainability report is an organizational report that provide information about economic, environmental, social and governance performance. Sustainability reporting is a term used synonymously with various concepts such as triple responsibility reporting, corporate social responsibility reporting, non-financial reporting and so on [4].

Companies can report about information by the stakeholders' request, so that the investors can evaluate the long-term viability of the company. They also report information that helps them to assess their long-term viability by analyzing their own

---

<sup>1</sup> PhD candidate, University of Bahçeşehir, [gulscin@hotmail.com](mailto:gulscin@hotmail.com)

<sup>2</sup> Lecturer Dr., Department of Accounting and Tax, Vocational School of Social Sciences, University of Istanbul, [tugce.uzun@istanbul.edu.tr](mailto:tugce.uzun@istanbul.edu.tr)

<sup>3</sup>Boğaziçi University- The Institute Of Social Sciences- Economics; [kistan3@hotmail.com](mailto:kistan3@hotmail.com)

operating models and activities and how they handle and influence social, economic, human, and natural resources. Companies will also disclose their positive and negative impacts on the economy, environment, and society. Corporate sustainability reporting submit company's sustainability strategies and progress that is made towards achieving goals.

Corporate sustainability is taken into account when defining business objectives, particularly with respect to issues relating to stakeholder demands and the environment. In this context new challenges are emerging for the automotive industry in general, and for OEMs in particular. In addition, stakeholder requirements, especially those of consumers and political representatives, are also undergoing rapid change. Here environmental acceptability, cleaner technologies, and new forms of mobility play a key role. Moreover, the motives behind consumer purchases are becoming less emotional and more functional. The OEMs are attempting to optimize existing power trains, develop innovative driving technologies and new distribution models, as well as to build an efficient global structure and network [1]. Many of the main car makers have joined the United Nations Global Compact (in chronological order: Daimler, BMW, Renault, Volvo, Volkswagen, PSA, Nissan, Ford, Hyundai and KIA) [3].

The automotive sector in Turkey is among the first three major sectors today. Share of the automotive and automotive parts production manufacturing in gross domestic product is at 20%, while its share in GDP is estimated at about 5%. Direct share of the automotive sector in industrial employment was 6%, and when including sub-industry and other sides, the share in industrial employment is expected to reach 20%. Automotive is in the medium-high tech sectors and also among the highest unit value-added sectors in the export of major industries and sub-industries. Its share in employment and because of being most export sectors, the sector have a strong effect on the entire economy as well as other sectors [4]- [5]. It is operating worldwide.

Parallel to the developments in worldwide, automotive company is supposed to be leading in sustainability activities and sustainability reporting.

### 3.LITERATURE REVIEW

This section presents an overview of the relevant literature.

Jasch & Lavicka (2006) conducted a study is based on a project with the Styrian automobile cluster in Austria and selected member companies. In six companies, the environmental management costs, as well as further costs for health and safety, risk management and other social issues were assessed. Less tangible items and external effects are addressed. Starting with the efforts to assess the financial effects of the sustainability performance indicators provided by the Global Reporting Initiative (GRI) for sustainability reporting, the UN DSD (United Nations Division for Sustainable Development) method for environmental management accounting (EMA) was enlarged by several other cost categories. This paper describes these and the experiences from the pilot projects. The two major cost drivers are the purchase costs of non-product output and the costs related to lost working days because of sick leave and accidents and the overtime pay to make up for these lost working days [7].

Kehbila, Ertel, & Brent (2010) conducted survey on the state of corporate sustainability within the South African automotive industry. The survey focused on the meaning and relevance of sustainability to South African automotive companies, and their use of different approaches to implement sustainability in corporate practice. On this score, the paper seeks to analyze and compare the levels of voluntary environmental initiatives between large and small and medium-sized enterprises within the automotive milieu. Survey results reveal that a majority of automotive companies have sought to improve their environmental performance by integrating environmental considerations into their core activities. Although the majority of these companies have standardized EMSs, our analysis reveals considerable differences between companies' approaches to corporate sustainability [8].

Cortez and Cudia (2010) studied of industries further explore how environmental innovations measured through environmental costs of Japanese automotive and electronics companies impact their financial performance. This study uses the descriptive and exploratory case study design in comparing five automotive and five electronic Japanese manufacturing companies' environmental innovations measured through environmental costs and the related impact on sales, net income and assets. Statistical tests using regression analysis reveal that environmental innovations in terms of costs show a linear relationship with the financial performance of Japanese firms included in the study. This might imply that any change in the environmental investments and expenses made by the companies would result to a corresponding level of change in their sales, net income and assets [9]. Sustainability reports of 14 manufacturers in the European automotive industry are analyzed with respect to issues of corporate sustainability implementation by Sukitsch, Engert & Baumgartner (2015). The main aim of this analysis to understand how manufacturers in the European automotive industry implement corporate sustainability. As a result the analysis shows that while companies are well-aware of the significance of sustainability for their industry, some tend to be leaders, and others laggards, as far as implementation is concerned. Results confirm the importance of specific policy instruments in implementation, such as the use of environmental management systems and standards, and of related changes in organizational structures [3].

As a result of PWC's (2011) study on 215 companies It is stated that a large portion of manufacturing companies published sustainability report. This result is important in today's conditions where the increasing importance of environmental factors [10]. Senal and Aslantaş Ateş (2012) examined the structure of corporate sustainability accounting and reporting process. In this study they claimed that sustainability development promotes using various accounting and costing methods such as environmental accounting, environmental managerial accounting, and life cycle costing [11]. With the integration of organizations to the world markets in Turkey, sustainability reporting will be important. Istanbul Stock Exchange Sustainability Reports of companies located in the Sustainability Index was investigated by Pamukçu and Ozdemir (2016). It was found that companies which is included in sustainability index have published business and incensant reports since 2007. In these

premises they concluded that companies share business of financial reporting as well as social, environmental and governance performance clearly [12].

#### 4. ANALYSIS OF SUSTAINABILITY REPORTING IN THE TURKEY AUTOMOTIVE SECTOR

Sustainability reports should focus on four main aspects of a company, including the social, environmental, economic, and governmental issues and advances. For most companies to have an interest in sustainable development needs to be an expected financial benefit. But often organisations are not able to precisely tell their environmental or social costs and even less, the benefits and savings from improved environmental and social performances. Many companies are interested in the social and economic dimensions of sustainable reporting. Especially environmental issues are not being priorities of many firms. For the automotive industry, social factors are important as well as environmental factors. Social Performance Indicators concerns the impacts an organization has on the social systems within which it operates. The GRI Social Performance Indicators identify key Performance Aspects surrounding labor practices, human rights, society, and product responsibility[4].

The main objective of the study is to determine social sustainability performance of companies which operates in the automotive sector in Turkey and the BIST Sustainability Index by using TOPSIS performance evaluation system.

In Turkey there are few studies done by TOPSIS method. Uygurtürk and Korkmaz (2012) in their study analyzed financial performance of the companies by TOPSIS method by using traded 13 base metal industry enterprises' financial statements in 2006-2010 in the Istanbul Stock Exchange (ISE). As a result, the performance scores of the basic metal industry company operating in the period of analysis were generally vary [13]. Demirelli (2010) for his work analyzed performance of public banks in operating nationwide widely by TOPSIS method. As a result of study, state-owned banks operating in nationwide commonly were affected by the local and the global financial crisis, performance points fluctuated constantly according to the data of the overseas, the banking sector did not achieve an improvement noticeable vary [14]. Ergüden and Çatlıoğlu (2016) investigated environmental performance evaluation of four chosen companies taking care of the sustainability report data published in 2013. Sustainable contribution to energy companies using TOPSIS method was examined on the basis of different criteria. Companies that most contribute to sustainability in Turkey was defined as Zorlu Energy [15]. CSR in the automotive industry comprises a great variety of issues emerging during the production, use and disposal phases. Automotive suppliers should adopt a lifecycle approach paying attention to CSR issues in all stages of their supply [16].

Sustainability reports of 4 companies listed in the BIST index (Doğuş Otomotiv, Ford Otosan, Otokar, Tofas) were included in the analys. The data used in this study were obtained by examining the sustainability report was published in the respective companies' web sites. Evaluation criterias were selected in accordance with the structure of the performance evaluation system of TOPSIS.

#### 4.1 TOPSIS Method

TOPSIS (Technique for Order Preference by Similarity to Ideal Solution) was developed in 1981 by Yoon and Hwang [17].

It based on the main principles that the proximity of the decision point to the ideal solution. TOPSIS method comprises a solution consisting of 6-step process. The steps of the TOPSIS method are described at below [18].

##### Step 1: Creating Decision Matrix (A)

Lines of the decision matrix consist of decision points that desired listed advantages, while the column is located assessment factors to be used in decision making. A matrix is the initial matrix created by the decision makers. The decision matrix is shown as follows:

$$A_{ij} = \begin{bmatrix} a_{11} & a_{12} & \dots & a_{1n} \\ a_{21} & a_{22} & \dots & a_{2n} \\ \cdot & \cdot & \cdot & \cdot \\ \cdot & \cdot & \cdot & \cdot \\ a_{m1} & a_{m2} & \dots & a_{mn} \end{bmatrix}$$

In  $A_{ij}$  matrix, M is the number of decision points, n is the number of data evaluation factors.

##### Step 2: Creating Standard Decision Matrix (R)

Standard Decision Matrix, taking advantage of the A matrix elements and is calculated using the following formula.

$$r_{ij} = \frac{a_{ij}}{\sqrt{\sum_{k=1}^m a_{kj}^2}} \tag{1}$$

R matrix is obtained as follows:

$$R_{ij} = \begin{bmatrix} r_{11} & r_{12} & \dots & r_{1n} \\ r_{21} & r_{22} & \dots & r_{2n} \\ \cdot & & & \cdot \\ \cdot & & & \cdot \\ \cdot & & & \cdot \\ r_{m1} & r_{m2} & \dots & r_{mn} \end{bmatrix}$$

**Step 3:** Creating Weighted Decision Matrix Standard (V)

First of all, weights for the evaluation factor ( $w_i$ ) is determined ( $\sum_{i=1}^n w_i = 1$ ). Then elements in each column of the matrix R is multiplied by the value corresponding  $w_i$ . V matrix is generated. V matrix is shown below;

$$V_{ij} = \begin{bmatrix} w_1 r_{11} & w_2 r_{12} & \dots & w_n r_{1n} \\ w_1 r_{21} & w_2 r_{22} & \dots & w_n r_{2n} \\ \cdot & & & \cdot \\ \cdot & & & \cdot \\ \cdot & & & \cdot \\ w_1 r_{m1} & w_2 r_{m2} & \dots & w_n r_{mn} \end{bmatrix}$$

**Step 4:** Creating ideal (+) and negative ideal (-)Solutions

TOPSIS method assumes that monotonically increasing or decreasing trend of each of the evaluation factors.

To build the ideal solution set, weighted assessment of the factors in the V matrix which is the largest of the column value (about evaluation factor minimization way the smallest) is selected. Finding the ideal set of solutions shown in the following formula.

$$A^* = \left\{ (\max_i v_{ij} | j \in J), (\min_i v_{ij} | j \in J') \right\} \tag{2}$$

Set will be calculated from the (2) formula shown as  $A^* = \{v_1^*, v_2^*, \dots, v_n^*\}$

Negative ideal solution set is created by selecting weighted assessment of the factors in the matrix V which is the smallest of the column value (corresponding evaluation factor maximization way is the greatest). The presence of negative ideal solution set shown in the following formula.

$$A^- = \left\{ (\min_i v_{ij} | j \in J), (\max_i v_{ij} | j \in J') \right\} \tag{3}$$

Set will be calculated from the (3) formula shown as  $A^- = \{v_1^-, v_2^-, \dots, v_n^-\}$

In both formulas also the value  $J$  shows benefit (maximization) and  $J'$  shows losses (minimization).

Both ideal and negative ideal solution set consists of a number of assessment factors that m elements.

**Step 5:** Calculation of Discrimination Measures

In TOPSIS method, the Euclidian distance approach is used in order to find the deviation of the value of evaluation factors for each decision point from the ideal and negative ideal solution sets. The deviations related to the decision point obtained here is called the measure of Ideally Discrimination ( $S_i^*$ ) and negative ideal Discrimination ( $S_i^-$ ). Ideal separation ( $S_i^*$ ) calculates by using the formula (4), wherein the calculation of the measure of negative ideal separation ( $S_i^-$ ) is shown in the formula (5).

$$S_i^* = \sqrt{\sum_{j=1}^n (v_{ij} - v_j^*)^2} \tag{4}$$

$$S_i^- = \sqrt{\sum_{j=1}^n (v_{ij} - v_j^-)^2} \tag{5}$$

Calculated number of  $S_i^*$  ve  $S_i^-$  will naturally be up to the number of decision points.

**Step 6 :** Calculating the relative proximity to the Ideal Solution

The calculation of the relative proximity of each decision point to the ideal solution ( $C_i^*$ ) is utilized from the ideal and negative ideal separation sizes. The criteria used here is the share of negative discrimination measure in total separation ideal measure. Calculating the ideal solution to the relative proximity values are shown in the following formula.

$$C_i^* = \frac{S_i^-}{S_i^- + S_i^*} \tag{6}$$

$C_i^*$  value is in the range of  $0 \leq C_i^* \leq 1$  and  $C_i^* = 1$  shows absolute closeness of the respective decision point to the ideal solution,  $C_i^* = 0$  shows absolute closeness of the respective decision points to the negative ideal solution.

## 4.2 Implementation

### 4.2.1 Companies Include in The Research

Companies include in the analyz is shown in Table 1.

Table 1: Companies include in the analyz

No.	Company Name
1	Doğuş Otomotiv
2	Ford Otosan
3	Otokar
4	Tofaş

### 4.2.2. Performance Data Of Companies

Performance data was choosen from sustainability reports, preparing according to GRI 4 standard, of the subject companies in 2015. Average training per employee and EHS training for cantractors and employee have been chosen as the social performance indicators. In this context, social performance data for choosing organizations are located in Table 2.

Table 2: The social performans data of the companies

Firm's	Average training per employee (Time/Employee)	EHS training for Contractors employees (The number of participants)	EHS training (The number of participants)
Tofaş	40,25	4392	8756
Ford	82	1681	10504
Otokar	25	127	1774
Doğuş Otomotiv	29	-	-

### 4.2.3 Creating A Decision Matrix

In the first step of the analysis is determined decision points and evaluation criteria. Table 3 shows the decision matrix. Lines indicate decision points and columns indicate the evaluation factors. Calculation of the evaluation factors in the matrix based on social performance indicators was published in the sustainability report of the organizations.

Table 3: Decision Matrix

Firm's	1	2	3
Tofaş	40,25	4392	8756
Ford	82	1681	10504
Otokar	25	127	1774
Doğuş Otomotiv	29	-	-

### 4.2.4 Standard Decision Matrix Creation

In the second stage of TOPSIS is creation of standart decision matrix. When to applying formula in step 2 of data in Table 3, we can get Table 4 values. The Table 4 shows us standard decision matrix of companies involved the research.

Table 4: Standard Decision Matrix

Firm's	1	2	3
Tofaş	0,4448	2,6053	0,8219
Ford	1,4761	0,3826	1,1757
Otokar	0,2609	0,0270	0,1297
Doğuş Otomotiv	0,3062	0,0000	0,0000

#### 4.2.5. Standard Weighted Decision Matrix Creating

In order to create a standard decision matrix, weight value must be determined as shown in Table 5.

Table 5: Weight Value

1	2	3
0,4000	0,3000	0,3000

Weight value is used in order to calculate weight standart matrix. Table 6 was created via multiple all the elements of Table 4 with elements of Table 5.

Table 6: Weight Standard Matrix

Firm's	1	2	3
Tofaş	0,1779	0,7816	0,2466
Ford	0,5904	0,1148	0,3527
Otokar	0,1043	0,0081	0,0389
Doğuş Otomotiv	0,1225	0,0000	0,0000

#### 4.2.6 Obtaining the Ideal Positive (A+) and Ideal Negative (A-) solution Value

The next stage of TOPSIS method is create solution set consists an ideal positive (A+) and negative ideal (A-) which is located in Table 7. Elements of the new table contain determining maximum and minimum values in our standard decision pillars.

Table 7: Ideal Positive (A+) With Ideal Negative (A-)

	Doğuş	Ford	Otokar
Min	0,1043	0,0000	0,0000
Max	0,5904	0,7816	0,3527

#### 4.2.7 Calculation of Discrimination Measures

The next stage of TOPSIS method is calculate the distance between alternatif. The values shown in Table 8 was calculated by using formulas (4) and (5).

Table 8: Distance between Alternatives

Firm's	S*	S-
Tofaş	0,4260	0,8229
Ford	0,6668	0,6115
Otokar	0,9659	0,0398
Doğuş Otomotiv	0,9769	0,0181

#### 4.2.8 Calculating the relative proximity to the Ideal Solution

The sixth stage of TOPSIS method is calculated of how close it is to find the place to each alternative of making ideal. The result located in Table 9 obtaining using Formula (6).

Table 9: Relative proximity of the Ideal Solution

Firm's	C*
Tofaş	0,6589

Ford	0,4783
Otokar	0,0395
Doğuş Otomotiv	0,0182

Order from bigger to smaller according to c\* value is Tofaş- Ford-Otokar-Doğuş. Tofaş has higher value with 0,6589 point. Ford is the second firm with 0,4783 points, Otokar is third firm with 0,0395 points and Doğuş is last company with 0,0182 points.

### 4.3 Result

In this study, social performance of four chosen companies was evaluated taking care of the sustainability report data published in 2015. The value of average training per employee and EHS training for contractors and employee chosen as determining factor for firms including research. In the end of this research, Tofaş is take the highest number with point 0.6589 giving importance training. Doğuş has a lowest performance with 0.0182 point. The information about EHS training was not found in Doğuş sustainability report.

### 5. CONCLUSION

Requirements for corporations to disclose corporate sustainability reports yearly continually grows, however with no universal guide or set requirements, corporations are at the leisure of disclosing whichever information they find most valuable to their own benefit. As business sustainability reporting becomes more common in the global marketplace. Car manufacturers still recognize the importance of corporate sustainability implementation in practice.

When viewing sustainability reports throughout time, they are used as a guide to putting the positive and negative aspects of the company into context year after year. If a company sets forth sustainability reports each year, it illustrates its dedication to the issue of sustainability.

### REFERENCES

- [1] Nunes, K., Valle, R., Schebek, L., & Peixoto, J. (2010). Automotive Industry Sustainability Reports: A Comparison Of Brazilian And German Factories. *VI CONGRESSO NACIONAL DE EXCELÊNCIA EM GESTÃO Energia, Inovação, Tecnologia e Complexidade para a Gestão Sustentável*, (s. 1-24). Brasil.
- [2] Lieback, J., Moosmann, S., & Felker, Y. (2013). *Sustainability Management In The Automotive Industry Drawn From Their Reporting*. Berlin: GUTcert.
- [3] Sukitsch, M., Engert, S., & Baumgartner, R. (2015). *The Implementation of Corporate Sustainability in the European Automotive Industry: An Analysis of Sustainability Reports*. September 12, 2016 Available: [www.mdpi.com/journal/sustainability](http://www.mdpi.com/journal/sustainability)
- [4] *Sustainability Reporting Guidelines*. (2000-2011). July 15, 2016 Available: [www.globalreporting.org:https://www.globalreporting.org/resource/library/G3.1-Guidelines-Incl-Technical-Protocol.pdf](http://www.globalreporting.org:https://www.globalreporting.org/resource/library/G3.1-Guidelines-Incl-Technical-Protocol.pdf)
- [5] TSKB Ekonomik Araştırmalar. (2015). *Otomotiv Sektöründe Üretim Kayıplarının Etkileri-Otomotiv ve Yan Sanayi Değerlendirmesi Mayıs 2015*. İstanbul: TSKB.
- [6] ODD. (2016). *Genel Değerlendirme Aralık 2015*. İstanbul : Otomotiv Distribütörleri Derneği.
- [7] Jasch, C., & Lavicka, A. (2006). Pilot project on sustainability management accounting with the Styrian automobile cluster. *Journal of Cleaner Production*, 1214-1227.
- [8] Kehbila, A., Ertel, J., & Brent, A. (2010). Corporate Sustainability, Ecological Modernization and the Policy Process in the South African Automotive Industry. *Business Strategy and the Environment*, 453-465.
- [9] Cortez, M., & Cudia, C. (2010). The Impact Of Environmental Innovations On Financial Performance: The Case Of Japanese Automotive and Electronics Companies. *Journal of International Business Research*, 9(Special Issue 1), 33-46.
- [10] PWC. (2011). *Türk İş Dünyası'nda Sürdürülebilirlik Uygulamaları Değerlendirme Raporu*. İstanbul: PWC.
- [11] Senal, S., & ASLANTAS ATEŞ, B. (2012). Kurumsal Sürdürülebilirlik İçin Muhasebe ve Raporlama. *Muhasebe ve Denetim Bakış*, 83-97.
- [12] Pamukçu, F., & Özdemir, Z. (2016). Kurumsal Sürdürülebilir Raporlama Sisteminin Borsa İstanbul Sürdürülebilirlik Endeksi Kapsamındaki İşletmelerde Analizi. *Mali Çözüm*, 13-35.
- [13] Korkmaz, H., & Uygurtürk, T. (2012, Ekim). Finansal Performansın TOPSIS Çok Kriterli Karar Verme Yöntemi İle Belirlenmesi: Ana Metal Sanayi İşletmeleri Üzerine Bir Uygulama. *Eskişehir Osmangazi Üniversitesi İİBF Dergisi*, 7(2), 95-115.
- [14] Demirelli, E. (2010). TOPSIS Çok Kriterli Karar Verme Sistemi: Türkiye'deki Kamu Bankaları Üzerine Bir Uygulama. *Girişimcilik ve Kalkınma Dergisi*, 5(1), 101-112.
- [15] Ergüden, E., & Çatlıoğlu, E. (2016). Sustainability Reporting Practiceses In Energy Companies With Topsis Method. *Muhasebe ve Finansman Dergisi*, 201-221.
- [16] Martinuzzi, A., Kudlak, R., Faber, C., & Wiman, A. (2011). CSR Activities and Impacts of the Automotive Sector. *RIMAS Working Papers*, 1-29.
- [17] Hwang, C., & Yoon, K. (1981). *Multiple Attribute Decision Making: Methods and Application*. NewYork: Springer.
- [18] M., Ö. (2014). Özdemir M., Bolum Adi: TOPSISTOPSIS: Operasyonel, Yönetmel ve Stratejik Problemlerin Çözümünde Çok Kriterli Karar Verme Yöntemleri. Bursa: Dora Basım-Yayın Dağıtım.



# Earthquakes And Rural Structures

*Sedat Karaman<sup>1</sup>, Zeki Gokalp<sup>2</sup>*

---

## **Abstract**

*Earthquakes occurred every year in various parts of the world cause serious loss of life and property. Such disasters also have negative impacts on country economies. About 30% of world population lives in rural sections and majority of casualties, damages and other physical hazards are experienced in rural parts. In case of a severe earthquake, casualties and injuries, livestock casualties, damaged buildings and other damages are mostly observed in rural structures. In various parts of the world, majority of the damages are also observed in rural structures because of improper site selections, poor-quality construction materials or local materials, improper design of these buildings and structures. Therefore in rural structures, earthquake-resistant structures should be constructed with light-weight durable materials to provide life safety of people living in these regions and to provide great contributions to country economy.*

**Keywords:** *Agricultural structures, rural settlements, earthquake*

---

## **1.INTRODUCTION**

Every year, earthquakes occur worldwide at different magnitudes and cause serious loss of life and property. Earthquakes also negatively influence country economies. About 30% of world population lives in rural sections [1] and majority of casualties, damages structures, loss of animals and other material damages in earthquakes are experienced in rural sections.

In less developed and developing countries, dwellings and agricultural structures in rural sections are mostly constructed with stone, adobe, and briquette or fired bricks as masonry constructions. These structures have quite low resistance against earthquake-like horizontal forces. There were serious loss of life experienced in recent earthquakes occurred in Turkey and Iran.

In various parts of the world, majority of earthquake-induced damage is observed in rural parts of the countries. As it was in East Marmora (17 August 1999) and Düzce (12 November 1999) earthquakes, serious loss of life and property observed in rural settlement units of Turkey was mostly because of traditional stone masonry constructions. Beside improper site selection for settlement places, usually locally available construction materials are used in rural structures. They are constructed with traditional or sometimes with primitive methods way behind engineering principles. Therefore, they don't have any resistance to earthquakes. Although the principles and implementations for rural structures were sufficiently specified in earthquake regulations, they are not obeyed properly, thus the mistakes and faults reducing earthquake resistance of these structures are evident. For earthquake resistant structures and buildings in rural settlement units, durable, light-weight, heat and moisture insulated materials should be used. Such materials and implementations will increase life safety of the people living these sections and will also provide significant contributions to country economies.

## **2.DEFINITION AND TYPES OF EARTHQUAKES**

Earthquake is sudden sliding in some parts of earth crust and resultant shaking of the surface of the earth through some geological phenomenon. In other words, earthquake is fracture or imbalance of flexible earth crust and resultant sudden release of energy to earth surface as shock waves. Earthquakes are classified under three groups based on the factors influencing their formation: tectonic, volcanic and collapse earthquake. About 90% of earthquakes worldwide are tectonic earthquakes. The core of the earth with about 3 600 km radius is full of hot and molten metals and it is overlaid with 2 900 km thick mushy mantle and the mantle is overlaid with 60-70 km thick lithosphere constituting continents, deep seas, mountains and valleys. Tectonic earthquakes are occurred through the movement of some parts of lithosphere over mantle layer. Volcanic earthquakes are formed through volcano eruptions. Collapse earthquakes are formed through the collapse of mine gallery or cavern roofs, or the collapse of roofs of cavities in saline and limey lands as a result of melting [2].

During the last 40 years worldwide, 30 earthquakes occurred at a magnitude of 8 and over, 530 earthquakes occurred at magnitudes between 7-8. In other words, 998 of thousand earthquakes occurred worldwide were at magnitudes less than 7 (non-harmful). However in underdeveloped countries, the earthquakes with magnitudes between 6-7 may cause serious disasters because of unplanned settlements and insufficient construction technology [3].

---

<sup>1</sup>Corresponding author: <sup>1</sup>University of Gaziosmanpaşa, Faculty of Agriculture, Department of Biosystems Engineering, 60250, Tokat/Turkey. [sedat.karaman@gop.edu.tr](mailto:sedat.karaman@gop.edu.tr)

<sup>2</sup>University of Erziyes, Faculty of Agriculture, Department of Biosystems Engineering, 38039, Kayseri/Turkey. [zgokalp@erciyes.edu.tr](mailto:zgokalp@erciyes.edu.tr)

### 3. THE FACTORS INFLUENCING DAMAGES ON RURAL STRUCTURES

The basic factors influencing the magnitude of earthquake damages on rural settlement areas can be gathered under the headings of: physical magnitude of the earthquake, distance of the earthquake from settlement areas, ground structure, quality of structures, national income level, rapid and uncontrolled structuring, unawareness and lack of education, measures taken before the earthquakes.

The primary danger in an earthquake is ground shaking and underground ruptures along the fault rupture zones. The secondary dangers are earthquake-induced landslides, earth liquefaction and settlements, large tsunamis in seas and periodical changes in water surfaces. The damages in rural structures are destructions or collapse of dwellings, livestock housings and storage structures. In addition, damages are also observed in dams, pipe lines, canals, weirs and similar structures. The damages exerted on agricultural machinery and tools are also seen as physical damages observed in rural sections. Analysis and designs through attentive engineering principles may prevent and mitigate such damages [4].

Earthquakes exert additional forces and create different impacts on structural members. The structures which are not able to resist against these impacts are either totally collapse or have slight, medium or heavy damages. Unconscious design practices for load-bearing system, construction system, material selection and implementations result in non-resistance against earthquake forces and end up with total collapse or heavy damage. Ultimately, serious loss of life and property are experienced. Since earthquakes exert some additional forces on structures, construction systems should be so designed as to resist against these forces [5].

Design and construction faults and environmental impacts may weaken load-bearing systems. Functional alterations in buildings also create serious damages on structures in case of an earthquake. Design, tools, workmanship and inspections not complying with earthquake regulations increase the destructive impacts of damages. The damages on structures vary based on the characteristics of the structures. Such characteristics include type of load-bearing system, material and workmanship quality, construction quality, number of floors, previous damages, aging of structures, additional loads, corrosion, alterations and etc. [6].

Constructional damages vary in urban and rural sections and there are also differences between the center and surroundings. Such differences are mostly resulted from the differences in construction techniques, workmanship quality or material use, sometimes also resulted from the mistakes made in design and detailing. Rural sections are composed of buildings commonly constructed with civil society architecture and specific local materials [5].

While reinforced masonry buildings are commonly used in agricultural structures of developed countries, regular or traditional masonry buildings are constructed with locally available construction materials in less developed or developing countries (Figure 1). Since any engineering service is not used in these buildings, serious loss of life and property is experienced in case of an earthquake [7].



Figure 1. Earthquake damages on rural structures

### 4. BUILDING SYSTEMS IN RURAL SECTIONS

**Stone masonry buildings:** Since stone is a heavy and brittle construction material, it is not proper to be used in agricultural buildings of heavy earthquake regions. However, in case of unavailability of better materials, it is used as a local and cheap construction material. In stone masonry buildings, foundation depth should be lowered beneath the freezing level, masonry rules should fully be obeyed, connections should be well-constructed, stones with regular geometries should be used, stones should be nonporous and durable, cement should be used instead of lime mortar or mud as a binding material, window spaces should not be large, lintels should be placed over doors and windows, intersecting walls should tightly be connected and horizontal girders should be placed. In addition to all these members, building corners should be supported with steel profiles to make the building resistance to earthquakes. Stone masonry buildings without these measures and constructed with oval stones can easily collapse even in mild earthquakes.

In rural settlement units composed of stone masonry buildings in Turkey, commonly single story buildings are constructed with stones taken from river basins and usually mud is used as binding agent. Roofs are usually covered with earthen material. Such

buildings do not have any resistance to earthquakes and can easily collapse even at mild earthquakes and cause serious loss of life and property. For instance in Bingöl earthquake of 2002, especially the dwellings and animal housings collapsed and local people experienced serious loss of material and property. It was observed that the buildings of the region were made of heavy and thick stone masonry walls and mud was used as the binding material [8].

**Brick masonry buildings:** Brick masonry buildings are quite less resistant to earthquakes than reinforced concrete structures. Since brick does not have a crystalline and layered structure, the masonry buildings made of brick do not exhibit a flexible behavior. Brick walls are brittle construction members. When they are constructed as reinforced masonry like reinforced concrete, they may gain a ductile characteristic. Their earthquake energy dissipation capacity through permanent deformation is quite lower than the reinforced concrete structures. Therefore, brick masonry buildings can be constructed maximum in 2 stories in 1st degree earthquake zones, in 3 stories in 2nd and 3rd degree earthquake zones and in 4 stories in 4th degree earthquake zones. A basement may also be constructed in these buildings. Brick masonry buildings should not be a public building like school, mosque, dispensary, workplace including several people inside [9].

Brick masonry buildings should have at least 10 cm thick reinforced concrete slabs and at least 20 cm wide reinforced girders should be placed over the walls where the slab rests on. In brick masonry buildings, upper sections of all doors and windows should be at the same level and the lintels should be continuous as to have a girder. More flexible and durable reinforced girder will reduce potential damages in case of an earthquake. [10].

**Adobe masonry buildings:** Adobe has been used as a construction material for centuries. It has quite low compressive strength and water resistance. It is commonly used in low-story rural dwellings. Majority of rural population lives in adobe masonry buildings since it is locally available throughout the world. Such buildings accommodate about 30% of world population. Considering the building physiology and ecological benefits of the material, it will be used in the upcoming years [11]. The horizontal layers created in masonry adobe walls may provide a slight resistance against earthquake. Vertical alignments should be diverted about 1/3 of a single adobe length to improve earthquake resistance. However, a regular adobe masonry wall has low resistance against compressive and shearing forces. The material exhibits plastic behavior when wetted, then loss the strength and may prone to collapses. Some admixtures are used while making adobes to improve their mechanical characteristics [12].

Alker is an adobe produced with 10-20% plaster admixture. The physical and mechanical characteristics of a regular adobe may significantly be improved with this plaster admixture. Tension strength of alker is higher than regular adobes and this increase the material resistance against earthquake-induced horizontal forces [13].

**Wood-frame buildings:** Since wood is an earthquake resistant and cheap construction material and has a high durability-weight ratio, it is commonly used in rural parts of the countries. It is usually used in forestry areas. Wood buildings are constructed in interlocking system and also connected with nails; therefore they can preserve their forms in case of an earthquake.

In wood frame buildings, the members constituting the walls should tightly be jointed. Plasterboard walls commonly used in hot and rainy regions should be avoided to be used in earthquake zones [2]. For desired resistance, wood frame should be properly attached to foundation, framework should be durable and able to transmit earthquake loads uniformly to entire building, constructional members should be jointed properly and the roof should be properly attached to the building underneath [14], [15].

## 5. CONSTRUCTION MEMBERS

**Roof;** Roofs exhibit greater movements or accelerations under horizontal earthquake forces and tend to slip away from other bearing members. The lighter the roof load, the smaller the shear force. In case of flat earthen roof, such a shear force is higher. Shearing trend of the roof exerts excessive pressure and force over the upper surface of the walls. Therefore, girders should be placed over load bearing walls [12]. In less developed countries, commonly flat earthen roofs are used. The roof is covered with earthen material and a new layer is placed and compacted every year. Such layers excessively increase the roof loads. Collapse of this heavy roof in case of an earthquake may result in serious catastrophes.

**Walls;** Walls should be light weighted as much as possible and they should not exert heavy loads to building frame. In this way, the building will gain an earthquake resistance.

A girder should be placed between foundation walls and load-bearing walls. Otherwise, the building mass over foundation walls exerts a shearing force like the one exerted by the roof in case of an earthquake and may result in collapse of the building (Figure 2)[12], [13]. The total porosity of the wall should not exceed 40% [10]. Proper vertical members should also be placed to improve earthquake resistance of the buildings. The binding materials used in the walls should be quality and proper materials. Cement or supplemented lime mortar should be used. Base plans of dwellings in 1st degree earthquake zones should be square, rectangular or circular to mitigate the impacts of earthquake forces [2].

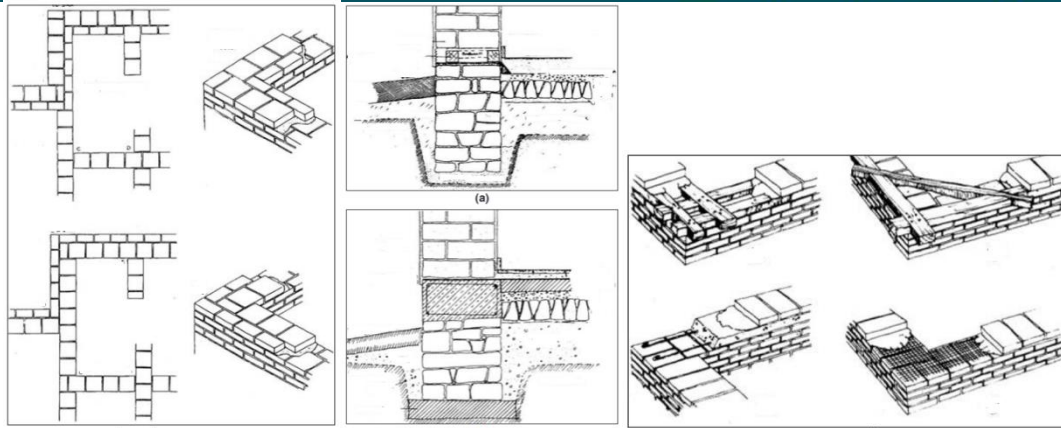

Figure 2. Adobe masonry wall and foundation configurations.

**Doors and windows:** The door and window sizes should not exceed 3 m<sup>2</sup> [11]. The number of open spaces like doors and windows should be kept at minimum, evenly distributed over long side walls. In this way, rotation tendency of the building may be reduced in case of an earthquake. A portable space mould should be placed for door and window spaces in wall masonry. The door and window spaces in adobe buildings should be placed at least 15 cm away from the corners and joint sections. Their width should be maximum 100 cm [13].

**Foundation;** In case of an earthquake, the movement of building mass varies in different and weak grounds and may result in different slides and collapses. Weakness and flexibility of foundation soil may increase the impacts of earthquake. Therefore in buildings to be constructed in earthquake zones, foundations should be extended to strong ground. A great attention should be paid in construction of foundations of especially the masonry buildings. Any settlement in weak foundations will result in cracks and weakness in upper walls and ultimately easy collapse of the building in case of an earthquake. Ground liquefaction may also create significant hazards on masonry buildings [16].

## 6.SITE SELECTION FOR RURAL SETTLEMENTS

Previous earthquakes clearly revealed that significance of site selection for settlement places [5]. Settlement pattern is an important parameter to prevent from the hazards of earthquakes. Placement of buildings, spacing between adjacent buildings and legal regulations play significant roles in settlement patterns [4].

While replacing the villages in rural sections, the safest sites should be selected for prevention from the negative impacts of possible earthquakes. Skirts of steep slopes with potential landslides, soft grounds and the sites close to fault zones should be avoided. Scientific data and principles should be used together with geological and ground surveys while selecting new rural settlement places. The major reason for cracks and damages on buildings in case of an earthquake is poor ground conditions and differential settlements in foundations constructed over such grounds. When the loads transmitted to ground through foundation walls were safely bearded by the ground and in the ground is homogeneous, differential settlements will not occur and damages can be prevented in this way. In new settlement places in severe earthquake zones, weak grounds should definitely be avoided earthquake severity and ground conditions should definitely be taken into consideration while constructing new buildings.

## 7.MEASURES TO BE TAKEN

Earthquake related problems in agricultural structures of the rural sections have not been clearly elucidated, yet because of difficulties in dynamic analysis. The measures to be taken for earthquake resistance of agricultural structures and some significant points to be considered may provide support in solution of such problems. It is impossible to prevent earthquakes, but it is possible to mitigate the damages created by earthquakes. In doing so, scientific approaches and special construction techniques should be used.

Since there aren't any distinct methods to estimate the occurrence of an earthquake, it impossible to take pre-measures to prevent the loss of life and property. Such a case is clearly evident in rural sections which are composed of primitive, traditional weak dwellings and agricultural structures. Serious loss of life and property is encountered even in low-magnitude earthquakes. The severity of losses, economic damages and social problems created by earthquakes total depend on measures to be taken before the occurrence of earthquakes. The following measures can be taken against earthquakes: Strengthening current dwellings and agricultural structures and making them earthquake resistant; reconstruction of weak structures; replacement of settlements. With these measures, loss of life and property may significantly be reduced. However, it is quite hard to implement such measures. So, they should be implemented by the state with special programs especially for the buildings in 1st degree earthquake zones [2]. Ground surveys and scientific principles should be taken into consideration while designing rural settlements, agricultural structures and facilities and agricultural engineers should also be consulted in these processes.

Public training and education is also a significant means of prevention of possible loss of life and property. The public should be informed through modern information and communication technologies, they should be trained about earthquakes and their

active participation into such training programs should be supplied. In these programs, possible measures to be taken against earthquakes should be explained. Training should also be provided about construction materials and earthquake-resistant buildings.

To minimize earthquake damages, the legal regulations to applied in a disaster should be reconsidered or reestablished if necessary, land-use plans should be renewed, risk of disaster should be assessed in macro and micro scale, risk plans and maps should be created, relevant scientific and technical plans and programs should be created, nationwide earthquake register networks and control systems should be established and comprehensive training programs should be developed [17]. Today, reasons of earthquakes, occurrence probabilities and their impact areas can be estimated, and then it is possible to prevent the conversion of an earthquake into a disaster. Right at this point, different professional groups and organizations should start working from the upper scale plans to building scale, data bases should be created and rescue teams should be established [5].

Since masonry buildings are common in rural sections, a special attention should be paid in design of them for their resistance against earthquakes. Agricultural structures are constructed as single or two-story buildings. Proper materials use and construction techniques will minimize potential impacts of earthquakes on these buildings. Therefore, nationwide standards should be established especially in earthquake zones for construction materials and light-weight materials should be used in rural structures.

## 8. CONCLUSION

It is evident that several measures can be taken in design, construction and inspection of rural structures to minimize the loss of life and property in earthquake zones. Awareness should be raised in rural settlement places with uncontrolled structuring for design and construction techniques of buildings. Ground surveys, proper design, quality materials and relevant inspections are the major requirements for safe and earthquake-resistant structures. Reinforced concrete quality should comply with standards and regulations, otherwise serious loss of life and property will be evident. Relevant administrative and technical measures should also be taken to improve building quality.

The primary principle is earthquake-resistant building design is; to have no damages in any structural or non-structural members in light-magnitude earthquakes; to have repairable damages in structural or non-structural members in medium-magnitude earthquakes; to prevent full or partial collapse of building in severe earthquakes.

The negative outcomes of potential earthquakes result from not only the insufficiencies in design and construction of agricultural structures, but also result from insufficiencies in design and implementations of rural settlements and improper implementations of pre-, during and post-earthquake activities. Relevant measures should be taken to mitigate the loss and damages caused by earthquakes in rural settlement places. A work sharing should be established among the public institutes, private organizations and non-governmental organizations.

## REFERENCES

- [1] R.Cofirman, N. Agnew, G. Auiston and E. Doehne, Adobe mineralogy: characterization of adobes from around the world, 6th international Conference on The Concervation of Earthen Architecture, Las Cruces,NM. 14-19 October 1990.
- [2] A.R. Uluata, ve Yağanoğlu, Deprem ve Kırsal Yapılar. Tarım ve Mühendislik Derg., *TMMOB Ziraat Mühendisleri Odası*, Sayı 14. s. 38-42. 1984.
- a. Ercan, Türkiye’de Depremler. [Online]. Available: [http://itubirlik.org.tr/wp-content/uploads/ali\\_ercan\\_makale.pdf](http://itubirlik.org.tr/wp-content/uploads/ali_ercan_makale.pdf), 2016.
- [3] P. Gülkan P. and O. Ergünay, *Yapı Dünyası Derg.*, 72, s 9-16, 2002.
- [4] N. Akıncıtürk, Yapı Tasarımında Mimarın Deprem Bilinci, *Uludağ Üniversitesi Mühendislik-Mimarlık Fakültesi Dergisi*, Cilt 8, Sayı 1, 2003.
- [5] S. B. Şengezer, 13 Mart 1992 Erzincan Depremi Hasar Analizi ve Türkiye’de Deprem Sorunu, *Y.T.Ü. Basın Yayın Merkezi*, 1999, İstanbul, 1999.
- [6] Ö. Uğur, Determining the Structural Properties and Earthquake Behaviours of the Rural Constructions In Manisa Region. Masters Thesis, Ege University, Department of Civil Engineering, p191, İzmir, 2008.
- [7] H. Binici, M.H. Durgun, Y. Yardım, Are The Mud Brick Structures Very Weak Against Earthquake? What Are The Advantages and Disadvantaged of Them?, *KSU Journal of Engineering Sciences*, 13(2), 2010.
- [8] N. Bayülke, Depreme Dayanıklı Betonarme ve Yığma Yapı Tasarımı, *İnşaat Mühendisleri Odası İzmir Şubesi*, Yayın No:27, 245s., İzmir, 1998.
- [9] N. Bayülke, Depreme dayanıklı betonarme ve yığma yapı tasarımı, *Niksar Deprem Semineri*, (Editör, Baki Canik), Ankara, s.37-82., 1992.
- a. Işık, Investigating The Desing Criteria of Alker Wall To Achive The Earthquake Safe Structure. Fifth National Conference on Earthquake Engineering, 26-30 May, AE-048, 7p, İstanbul, Turkey, 2003.
- [10] Z. Alkan, Deprem ve Kerpiç, *Ziraat ve Yayım*, 4.s.15-17, 1971.
- [11] R. Kafesçioğlu and E. Gürdal, Çağdaş Yapı Malzemesi-Alker (Alçılı Kerpiç), *İTÜ.*, pp. 40, İstanbul, 1985.
- [12] G. Iizuka, On the damage and caution to wooden houses by recent earthquakes in Japan, Proceedings of the Seventh World Conference on Earthquake Engineering September 8-13, 1980 ( 7th WcEE İst. 1980 ), v.5, p.121-124, 1980.
- a. Aksoy, Z. Ahunbay, Behaviour of Turkish traditional timber framed houses against eartquaes, *İtüdergisi/a mimarlık, planlama, tasarım* Cilt:4, Sayı:1, 47-58 Mart, 2005.
- [13] N. Kumbasar, and Z. Celep, Yapı Dinamiği ve Deprem Mühendisliğine Giriş, Beta Dağıtım, İstanbul, 2004.
- [14] O. Ergünay, Afet Yönetimi Nasıl Olmalı?, *İTÜ Vakıf Dergisi*, 1999 Aralık, 30:79, 1999.

# Quantitative and Qualitative Aspects of Remittances, Comparative Analysis of Albania and Macedonia

*Agim Mamuti<sup>1</sup>, Mehmed Ganic<sup>2</sup>*

---

## Abstract

*The issue of emigration is a very important concern for Albania and Macedonia due to the fact that a high percentage of their population has left the countries in the last two decades, making these two countries one of the countries with the highest emigration percentage flows in the world. Migrant remittances are an increasingly important source of income for both countries. For these two economies, remittances are the largest type of international financial inflow and are larger than either capital inflows or official development assistance. These remittance inflows have allowed domestic consumption and investment to be substantially higher than what would have been possible otherwise and have contributed significantly to the developmental prospects of these two economies. In addition, the outflow of labor from these economies has helped to relieve chronically high unemployment which has characterized them since the transition process began in the early 1990. This paper analyses the quantitative and qualitative aspects of the remittances flows and highlight migration issues that are of specific context for Albania and Macedonia, respectively.*

**Key words:** *remittances, migration, quantitative, qualitative, Albania, Macedonia*

---

## 1. INTRODUCTION

Remittances have grown rapidly in recent years and have proved to be a stable source of finance for many countries, which can be of relief during difficult economic times. Albania and Macedonia are interesting case studies for various reasons. Firstly, they are countries that have experienced extensive emigration. Large number of Macedonia's and Albania's populations has emigrated. Secondly, South-Eastern Europe is the region that receives one of the highest amounts of remittances in the world. Albania and Macedonia, as small Southeast European economies, have been receiving a growing amount of remittances throughout the years. There are a high percentage of remittance-receiving households at national level in both Albania and Macedonia.

## 2. LITERATURE REVIEW

Migration and remittances may have important economic consequences. It is widely acknowledged that remittances have positive effect on the receiving country. Money sent by emigrants can reduce the poverty and generate substantial welfare gains for migrants and their families (WB, 2006). Large size of remittances relative to other external flows and to the GDP indicates that macroeconomic effects are also substantial. Remittances flows can influence the foreign exchange rate, domestic interest rates, and the balance of payments. Large inflows can also have some undesirable side effects weakening the institutional capacity of the state.

Earning remittances through emigration is seen by most Albanians as the most effective way of coping with the country's very difficult economic conditions and ultimately to escape poverty at the individual and household level (De Soto et al., 2002). Albanian migrants working abroad have sent home remittances variously estimated (because of the uncertainty over the volume of unrecorded transfers) to be somewhere between \$300 million and \$1 billion per annum: the country's major source of external income after aid. Put another way, the remittances sent by one Albanian migrant are equivalent to 2.5 times the sum of the average wages of all members of a family (Misja and Misja, 1995).

Connected to a long lasting migration history, remittance flows into Macedonia are remarkable. However, as in many other remittances receiving countries in the world, official data on remittances are scarce and they may significantly underreport actual money transfers, as many migrants send remittances via informal channels. By definition of the IMF and the World Bank, official remittances data include migrants' transfers in addition to workers' remittances and compensation of employees. This data cannot be calculated in the case of Macedonia, because the Macedonian national bank records migrants' transfers as part of cash exchange which also incorporates payments for unrecorded trade and services. An estimation which included all three remittances categories found remittances in Macedonia to amount to 15.2% of GDP in 2004 (Mansoor and Quillin, 2007).

## 3. QUANTITATIVE ASPECTS OF REMITTANCES

### 3.1. QUANTITATIVE ASPECTS OF REMITTANCES IN MACEDONIA

---

<sup>1</sup> Assoc.Prof.Dr. at the Faculty of Business and Economics, University of New York in Tirana (UNYT), agim.mamuti@yahoo.com

<sup>2</sup> Assoc.Prof.Dr. at the Faculty of Business and Administration, International University of Sarajevo (IUS), mganic@ius.edu.ba

Remittances constitute an increasing source of revenue for many families in the former Macedonia. At a macro level, remittances finance the balance of payment (i.e. without remittances the current account balance would deteriorate) (Markiewicz, 2006). In fact, is among the top 30 developing countries with respect to the highest remittances received as a percentage of GDP, 11th, and with the highest remittances per capita, 278th in 2002 and that makes it the 14th, (OECD, 2006).

What constitutes remittances varies from one source to another. For example, the figures show different amounts when considering the National Bank of Macedonia (NBM) and the World Bank (WB) data. The difference lies in the definition adopted. The WB one is much broader and is the summation of three components, namely: workers' remittances, compensation of employees and migrant transfers. In other hand NBM, the migrant transfers includes in the cash exchange. Since this category includes also payments for unrecorded trade and services, the realistic estimate of migrants' transfers is somewhere within this range (Markiewicz, 2006).

This difference becomes even more complex when considering other sources, such as the IMF data. The figures on remittances as percentage of GDP and of exports vary dramatically according to the source. For instance, in 2002 remittances amounted to 15.2% of GDP according to the Center for Research and Policy Studies in Skopje, whereas in 2003 this constitutes only 3.7% (Schorooten, 2005). For 2005, Joanne Van Selm cites IMF figures on remittances as high as 18% of GDP. This is mainly due to the slightly different definitions of remittances of IMF: the sum of the compensation of employees, worker's remittances, and other current transfers in other sectors (Van Selm, 2007).

Table 1: Annual remittance flows for Macedonia (BPM5 Framework)\*

	Inflows				Outflows			
	Workers' remittances	Compensation of employees	Migrants' transfers	Migrant remittances	Workers' remittances	Compensation of employees	Migrants' transfers	Migrant remittances
2000	80.5	0.4	0	80.9	14.2	0.0	0	14.2
2001	68.0	5.4	0	73.4	20.5	0.0	0	20.5
2002	92.4	13.5	0	105.9	22.5	0.7	0	23.3
2003	145.7	27.9	0	173.7	15.4	0.6	0	16.1
2004	161.1	52.0	0	213.0	14.7	1.4	0	16.2
2005	169.4	57.2	0	226.6	14.0	1.5	0	15.5
2006	197.6	68.9	0	266.6	15.6	2.2	0	17.8
2007	239.2	105.8	0	345.0	22.3	2.5	0	24.9
2008	266.1	140.5	0	406.6	28.2	4.8	0	33.0
2009	260.1	121.0	0	381.2	22.3	4.0	0	26.3
2010	259.9	128.1	0	387.9	19.3	3.4	0	22.6
2011	271.3	162.4	0	433.7	20.7	3.6	0	24.3

Source: National Bank of Republic of Macedonia, Statistics, Balance of Payments Database

\* BPM5: The sixth edition of the Balance of Payments and International Investment Position Manual (BPM6, the Manual) published in 1993 serves as the standard framework for statistics on the transactions and positions between an economy and the rest of the world.

Most remittances are sent from Western Europe. Based on the World Bank's estimates, more than 70 percent of remittances come from Western Europe (more than 60 percent from EU countries). While Germany, Switzerland, and Italy are undoubtedly the most prominent contributing countries, other survey-based sources also list the United States as a secondary remittance sending country (see, for instance, Roberts et al., 2008).

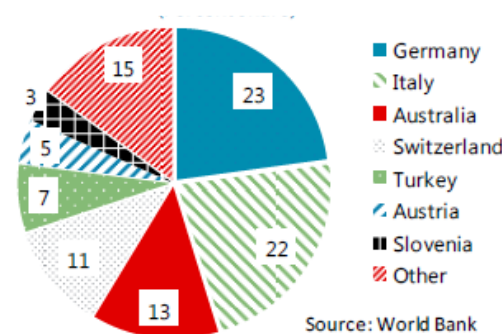

Figure 1 Origin of Remittances, 2012 (Percent share)

### 3.2. QUANTITATIVE ASPECTS OF REMITTANCES IN ALBANIA

The Bank of Albania calculates remittances as the difference between foreign currency coming in and foreign currency going out. This calculation does not exclude the possibility that income from suspicious activities, such as trafficking, is also taken into account.

Table 2: Annual remittance flows for Albania (BPM5 Framework)

(US \$, millions)

	Inflows				Outflows			
	Workers' remittances	Compensation of employees	Migrants' transfers	Migrant remittances	Workers' remittances	Compensation of employees	Migrants' transfers	Migrant remittances
2000	530.8	67.0	0.0	597.8	0.0	0.0	0.0	0.0
2001	614.9	84.4	0.0	699.3	0.0	0.0	0.0	0.0
2002	643.4	90.1	0.0	733.6	0.0	0.0	0.0	0.0
2003	778.1	110.6	0.0	888.7	0.0	4.1	0.0	4.1
2004	1,028.4	132.3	0.0	1,160.7	0.0	4.9	0.0	4.9
2005	1,160.7	129.0	0.0	1,289.7	0.0	6.5	0.0	6.5
2006	1,175.6	183.9	0.0	1,359.5	0.0	26.5	0.0	26.5
2007	1,304.6	163.5	0.0	1,468.0	0.0	9.9	0.0	9.9
2008	1,225.5	269.5	0.0	1,495.0	0.0	15.9	0.0	15.9
2009	1,091.2	227.3	0.0	1,318.5	1.4	8.6	0.0	10.1
2010	924.3	231.7	0.0	1,156.0	8.9	15.3	0.0	24.2
2011	965.0	196.8	0.0	1,161.8	7.0	14.2	0.0	21.2

Source: IMF Balance of Payments Database

With over a million Albanians living outside of the country, it is no surprise that both research and politics increasingly pay attention to the role of these emigrants. Many emigrants send remittances, with an immediate impact on the disposable household income of family members left behind. Indeed, remittances have been considered a major factor for boosting consumer expenditure in Albania, and are widely credited for fuelling the construction sector in the country. Figure 2 shows that the total amount of remittances sent to Albania has steadily increased between 2001 and 2008. Very broadly, this increase seems to correspond to the increasing number of Albanian emigrants. The highest amount of remittances recorded was in 2008 with 1,495 million USD. This is equivalent to 11.5 percent of the annual GDP that year, highlighting the important role that remittances play in the Albanian economy.

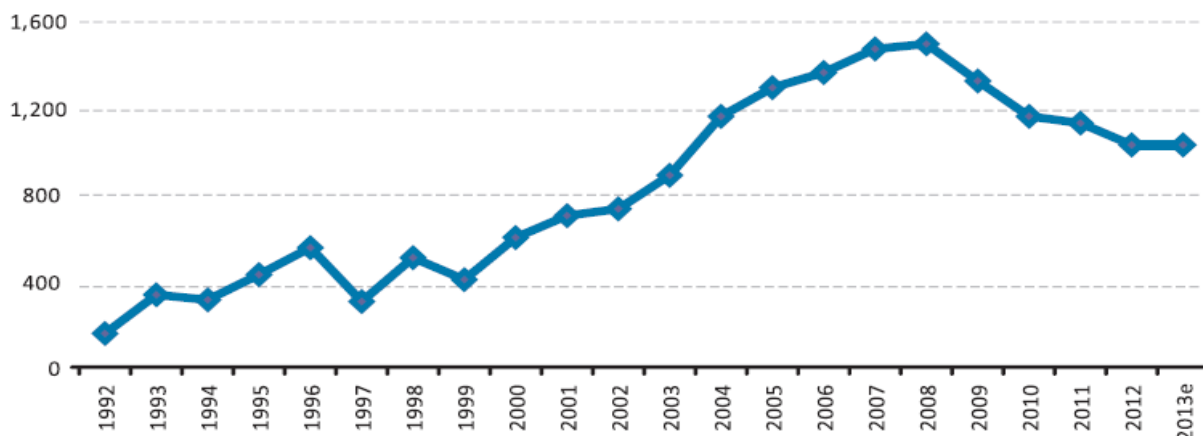

Figure 2 In-flow of remittances, 1992 – 2013, in millions of USD

Source: World Bank: Migration and Remittances data (updated as of January 2014).

During the same period, Albania enjoyed considerable and uninterrupted economic growth at an average of 5.9 percent annually (2003 – 2008). In the wake of the Great Recession, as Figure 3 illustrates, the flow of remittances has clearly decreased. This is directly related to the economic situation in Greece and Italy, the two countries accounting for the largest shares of remittances. Figure 3, illustrates that Greece and Italy jointly account for 85 percent of the remittances. This compares to around 85 percent of the emigrant stock in these two countries.



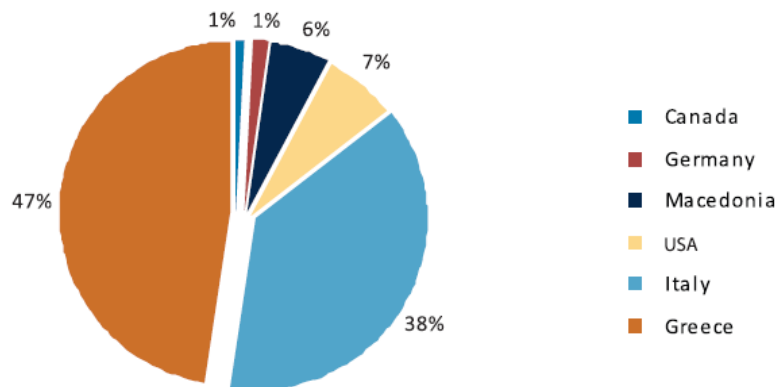

Figure 3 Remittances in 2011 by country of origin, in (%)

Source: World Bank

## 4. QUALITATIVE ASPECT OF REMITTANCES

### 4.1. QUALITATIVE ASPECT OF REMITTANCES IN MACEDONIA

There is no official governmental measurable feature of the qualitative aspect of remittances in Macedonia. However, the study done by the Center for Research and Policy Making (2007), estimates that only 15% of the financial transfers were made through official channels (i.e. banks – there is no mention of money transfer operators). The study estimated that the remainder is brought in the country either by migrants themselves or through “couriers” such as friends, relatives, coach carriers or other private tour operators, but no figures are provided. The Macedonian migrant sends home remittances very often, i.e. on a monthly or bimonthly basis. 32.4% of Macedonian Migrants are estimated to be remittance senders. Male migrants are more likely to send home remittances, although the gender discrepancy in this case is rather small. The same source reveals that 33% of the migrants believe remittances are important to their families and a World Bank study estimate that remittances constitute up to 5% of the total household expenditure (Mansoor and Quillin, 2007).

### 4.2. QUALITATIVE ASPECT OF REMITTANCES IN ALBANIA

The amount of remittances to Albania is three times as high as foreign net direct investments and nearly twice as much as the official development aid received by Albania (Social Policies Institute, 2007). Albanian emigrants mainly send remittances through informal channels (77.4%) – primarily by hand; and less with the formal ones (22.6%) - the banking system remaining the least preferred formal channel (World Bank, 2006). Due to geographical locality Albanians residing in Greece or Italy travel an average of 2-3 times per year to Albania and bring the money with them.

Money Transfer Operators (MTOs) dominate the formal market for money transfers to Albania from Italy (WB, 2006). The MTOs have advantages compared to the banks, such as faster transfer services, and no requirement for a bank account for the sender. In addition, recipient migrant households in Albania lack easy access to the banking sector. The results of the emigrant households’ survey undertaken by IOM in Albania in 2005 indicate that emigrant households in Albania show little familiarity with the banking system in Albania. Only 45.3% of all households in Albania maintain a bank account. When only emigrant households residing in rural areas are considered, the percentage is even lower (IOM, 2005).

Overall, the following factors seem to limit the formal transfer of migrant remittances to Albania: difficulties in accessing banking services by migrant senders in the host country, relatively slow speed of bank transfers, little trust in the Albanian banking services among senders and recipients of remittances, high transfer fees, and the strength of an informal money exchange market in Albania (De Zwager, 2005).

68.6% of emigrants send remittances back to Albania. The most common recipients are the parents of the sender, then spouse and children, followed by extended family. Financing the families’ daily needs is the primary use of remittances, followed by construction, upgrading and furnishing homes; and investment in real estate. According to the results of the Living Standard Measuring Survey (LSMS) in 2002, remittances from emigrants represented 13% of the average household income, while for recipient households they represented 47% of the household income. The average size of monthly remittances was 13,600 Lek or USD 95 (IMF, 2005).

Using data from the LSMS 2012, with regard to remittances, it is possible to describe the flow of remittances from the perspective of households that receive them. The households were asked about members that were currently abroad to get information on the status of employment, remittances and some demographic characteristics. As Figure 4 illustrates, about 46 percent of current migrants send remittances at home, mostly in cash (35 percent) but also in kind, or both. The figures are well related with the status of employment, those who are currently working accounting for 66 percent.

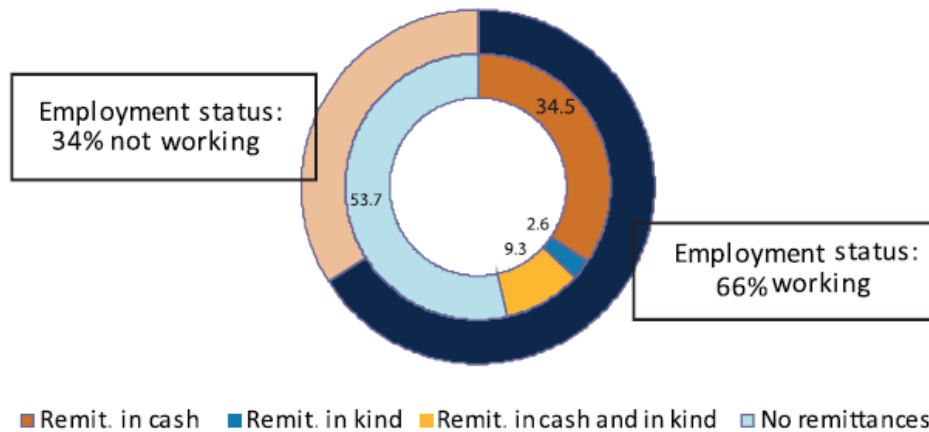

Figure 4 Flow of remittances to households during 2012 and employment status of current migrants, in (%)

Source: LSM 2012, INSTAT

Data from LSMS 2012 show that remittances are used for household expenditures and a small part is dedicated to the remittance sender's use. Only 3 percent of the migrants living currently abroad seem to send money for their own use (according to the declaration of the household). When it comes to how these remittances for the sender's use are used once sent to Albania, nearly 80 percent of the money is invested in construction work, with another 16 percent invested in business development. These estimates correspond with other studies that report that between 10 and 12 percent of remittances are invested rather than spent on household expenditure (LSMS 2002, ETF 2007, de Zwagger et al. 2010). With so much money invested in property; it is easy to see why remittances and the construction sector are seen as closely linked in Albania. These are forms of investment where remittances add to long-term development in some form, in the sense that almost all the money is invested in potentially durable products – as opposed to direct consumer spending. This said, with the figures presented here it is impossible to establish the quality and sustainability of the investments undertaken. A new building in the wrong location may end up unused, hence making no durable contribution to the country. By contrast, investments in buildings where members of the family live in reflect upgrades in living standards that are a sustainable contribution to the family and the country more widely. For example, investments in sanitation will have direct benefits for the health of the family, which indirectly benefits the country by keeping healthcare costs down.

## 5. CONCLUSIONS

Private transfers including remittances are a major source of financing for the large trade deficit in Macedonia. Private transfer inflows have represented a stable and major source of financing of external accounts over the past decade. The amount of private transfers in percent of GDP, in the last ten years, has fluctuated between 13 and 21 percent of GDP.

Macedonia is also an exceptional case insofar as remittances and other private transfer inflows are large enough to almost cover the entire trade deficit, thus making a key contribution to reserve accumulation and external stability in the context of the peg to the euro. Other than exports, private transfers constitute the largest source of foreign exchange for Macedonia. As a fairly stable source of financing, private transfers have contributed to the economy's resilience to the crisis.

During the last two decades, Albania received large amounts of remittances and became a main source of financing the great imbalance between the exports of goods and imports of services, by reducing the current account deficit. Inflow of remittances affects economic growth positively improving the balance of payment position and reducing dependence on external borrowing.

Remittances are an important economic source for many Albanian families too, and it appears that a significant part is invested – particularly in buildings – rather than simply spent on consumer goods. This suggests that in many cases, migration does indeed improve livelihoods with wider benefits for society such as in terms of improved health and welfare. These trends are reflected in lower poverty rates in households involving migrants, although differences may be less pronounced than they were in the past.

Both, for Albania and Macedonia, the proper measurement of remittances are essential for estimating their impact on the economy and making optimal policy decisions. There is broad consensus in the literature as well as at policy-making levels on the uncertainty of the true magnitude of remittances. Considering the critical nature of remittances for the Albanian and Macedonian economy, domestic surveys on recipient households should be conducted on a more frequent basis. These should be combined with a comprehensive census of the diaspora through consular offices, so as to allow a better understanding of the location, skills, and experience of migrants.

## REFERENCES

- [1] Center for Research and Policy Making (2007): Strengthening Cross-Border Cooperation in the Western Balkan Regarding Migration Management. Macedonia. Migration Flows in Modern Macedonia. Skopje, p. 9

- [2] De Soto, H., P. Gordon, I. Gedeshi and Z. Sinoimeri 2002. Poverty in Albania. A Qualitative Assessment. Washington DC: World Bank Technical Paper.
- [3] De Zwager, N., Gedeshi, I., Germenji, E., Nikas, C., IOM Tirana (2005): Competing for Remittances.
- [4] De Zwager, N., Gedeshi, I., Germenji, E., Nikas, Ch., (2005): A study on: Competing for remittances, IOM, Tirana, Albania.
- [5] De Zwager, N., Gressman, W., Gedeshi, I., (2010): Market Analysis: Albania – Maximising the Development-Impact of Migration-related Financial Flows and Investment to Albania, Vienna.
- [6] ETF, (2007): The contribution of human resources development to migration policy in Albania, Tirana.
- [7] INSTAT, Living Standards Measurement Study (LSMS) 2012
- [8] Mansoor, A. M. and Quillin, B. (eds.) (2006): Migration and Remittances. Eastern Europe and the Former Soviet Union. Washington: The World Bank.
- [9] Mansoor, Ali Quillin, Bryce (2007): Migration and Remittances. Eastern Europe and the Former Soviet Union.
- [10] Markiewicz, Malgorzata 2006. Migration and Remittances in Macedonia. Center for Economic Analyses. Skopje.
- [11] Misja, V. and A. Misja 1995. 'Emigracioni Ndërcombetar dhe Familja – Lidhjet e Ndërsjellta'. MM, 1.
- [12] OECD (2006): International Migration Outlook. SOPEMI report.
- [13] Roberts B., Markiewitz M., Nikolov M., Stojkov A., (2008), "A study on determinants and trends in remittance flows in Macedonia," Center for Economic Analyses (CEA) and USAID.
- [14] Schorooten, Mechthid 2005. Bringing Home the Money: What Determines Worker's Remittances in Transition Countries? The Institution of Economic Research/DiW (German Institute for Economic Research).
- [15] Social Policies Institute (2007): Report on exiting initiatives over the regulation of foreign currency exchange and investment in Albania.
- [16] Van Selm, Joanne (2007): Macedonia: At a Quiet Crossroads. Migration Information Source at Migration Policy Institute. Washington, D.C.: World Bank.
- [17] WB, 2006, Global Economic Prospects, no. 34320, Economic implications of remittances and migration.
- [18] World Bank (2006): Italy-Albania Remittance Corridor.

# Effects Of Deficit Irrigation On Some Physiological Parameters Of Pumpkin Seed

Hasan Ali Irik<sup>1</sup>, Halil Kırnak<sup>1</sup>, Abdullah Ulas<sup>2</sup>

---

## Abstract

The present study was conducted to investigate the effects of different irrigation water levels on some physiological parameters (leaf water potential, chlorophyll content and carotenoid content) of pumpkin seed. Experiments were carried out over the experimental fields of Erciyes University Agricultural Research Center in 2015. Six different irrigation water levels based on supply of deficit water (I100, I80, I60, I40, I20 ve I0) were applied in experiments. Leaf water potential (LWP) seasonally varied between 1.3-2.7 bar. The differences in chlorophyll contents of the treatments were found to be significant ( $P<0.05$ ). The lowest chlorophyll content was obtained from I0 treatment with 1229.15 mg g<sup>-1</sup> DTW and the greatest value was obtained from I100 treatment with 1550.85 mg g<sup>-1</sup> DTW. Significant differences were also observed in carotenoid of different irrigation treatments ( $P<0.01$ ). The lowest carotenoid content was observed in I0 treatment with 341.08 mg g<sup>-1</sup> DTW and the greatest value was observed in I100 treatment with 412.52 mg g<sup>-1</sup> DTW.

**Keywords:** Deficit irrigation, drip irrigation, pumpkin seed

---

## 1. INTRODUCTION

Environmental abiotic stress conditions, especially drought and salinity, are the primary factors reducing crop yields worldwide [1]. Crop production is a complex system among plant-soil-atmosphere. Plant water balance to be supplied within this plant-soil-atmosphere system is a significant issue in irrigation practices. For an efficient irrigation water use, irrigation programs should be so created as to consider these three factors [2].

Physical status of plants is greatly influenced by soil and environmental conditions. Water stress may be identified through either soil moisture status or plant moisture status. Today, there are several studies about decisions in water management practices through monitoring the plants. The leaf water potential (LWP) and leaf relative water content (LRWC) are primary parameters used in monitoring the status of plants [3]. Decreases in plant water potential and relevant relative water content are the indicators of water deficit-induced stress conditions. Therefore, for identification of the plants experiencing water stress, LWP and LRWC are measured [4]. Water deficits negatively influence cell growth and development and hinder plant physiological activities. Significant relationships of LWP with photosynthesis rate, transpiration rate and stomatal conductance in previous studies [5]. Chlorophyll content and photosynthesis rate decreases with decreasing leaf water potential. Negative impacts of water deficits on LWP and chlorophyll content were also reported in several previous studies ([3], [6], [7] and [8]).

There are not any studies about the effects of water deficits on physiological parameters of pumpkin seed plants. Therefore, the present study was conducted to investigate the effects of different irrigation water levels on some physiological parameters (LWP, chlorophyll and carotenoid content) of pumpkin seed plants which is a significant income source of Central Anatolian farmers.

## 2. MATERIAL AND METHODS

Experiments were conducted in Agricultural Research and Implementation Farm of Erciyes University in 2015. The research site has an average altitude of 1094 m and located between 34° 56' - 36° 59' east longitudes and 37° 45' - 38° 18' North latitudes. Climate data of the research site for the year 2015 is provided in Table 1. There was a total of 142 mm precipitation during the growing season of the plants.

---

<sup>1</sup>\*Corresponding author: Erciyes University, Department of Biosystems Engineering, 38038, Melikgazi/Kayseri, Turkey. haliirik42@gmail.com

<sup>2</sup>Erciyes University, Department of Soil Science and Plant Nutrition, 38038, Melikgazi/Kayseri, Turkey. agrulas@erciyes.edu.tr

Table 1. Climate data for the growing season of 2015

Meteorological data	Months			
	May	June	July	August
T <sub>ort</sub> (°C)	15.89	18.15	22.15	26.69
T <sub>max</sub> (°C)	22.55	24.33	30.06	32.67
T <sub>min</sub> (°C)	9.34	11.98	14.24	20.71
Wind speed (m/sn)	1.75	1.46	1.69	1.87
Precipitation (mm)	25.60	114.80	0.40	1.20
RH <sub>max</sub> (%)	77.62	85.72	70.56	60.26
RH <sub>min</sub> (%)	31.79	39.71	23.52	22.82

Soil samples were taken from 3 different locations at 4 different depth segments (0-30 cm, 30-60 cm, 60-90 cm and 90-120 cm) and analyses results are provided in Table 2. Irrigation water quality analyses were also performed and analysis results are provided in Table 3. Double-ring infiltrometer tests were performed at 3 different locations of the research site and soil infiltration rate was determined as 23.3 mm/h.

Table 2. Soil characteristics of the research site

Soil characteristics	Soil depth			
	0-30 cm	30-60 cm	60-90 cm	90-120 cm
Texture	Loam	Loam	Clay Loam	Loam
EC mmhos/cm	0.22	0.173	0.258	0.191
pH	8.13	8.17	8.14	8.23
FC, P <sub>w</sub> (%)	23	26	26	25
PWP, P <sub>w</sub> (%)	10.73	11.38	9.3	9.37
Bulk Density gr/cm <sup>3</sup>	1.27	1.24	1.22	1.28
Organic Matter, %	1.25	1.05	0.69	0.73
Lime, %	2.54	5.83	3.15	6.2
N kg/da	2.15	1.05	0.4	0.4
P <sub>2</sub> O <sub>5</sub> kg/da	2.05	1.15	0.6	0.2
K <sub>2</sub> SO <sub>4</sub> kg/da	27.16	37.64	31.01	31.01

Table 3. Irrigation water quality parameters

pH	EC(μS)	Na <sup>+</sup> (mg L <sup>-1</sup> )	K <sup>+</sup> (mg L <sup>-1</sup> )	Ca <sup>+2</sup> (mg L <sup>-1</sup> )	Mg <sup>+2</sup> (mg L <sup>-1</sup> )	HCO <sub>3</sub> <sup>-</sup> (mg L <sup>-1</sup> )	CO <sub>3</sub> <sup>-2</sup> (mg L <sup>-1</sup> )	SAR	Class
7.60	242	11.6	4.57	26.4	6.63	12.2	< 1.0	2.86	C1S1

Experiments were conducted in randomized block design with 3 replications. Plant row spacing was 100 cm and on-row plant spacing was 60 cm. Each plot had 8 plant rows. The initial two rows of each plot and the a row from the top and bottom of each plot were omitted as side effects. About 2 m spacing was left between the plots and 2.4 m spacing was provided between the blocks. Based on soil analysis, DAP fertilizer was applied to each plot as to have 12 kg/da N, 12 kg/da P and 10 kg/da K. Half of N and P was manually applied together with sowing and half of remaining section was applied at flowering the rest was applied at 50% fruit set stage. K fertilization was not performed because of sufficient K levels of research fields.

Drip irrigation system was used for irrigation of pumpkin seed plants. Irrigation water was supplied from a deep well opened in research field. An irrigation system was designed in accordance with the principles specified in [9]. Dripper spacing was selected as 0.33 m, dripper discharge was 4 lt/h, lateral diameter was 20 mm, manifold diameter was 40 mm and main line diameter was 63 mm. Water gauges were placed in front of each block to measure applied water. Wetted area was set as 66% as specified by [9].

Soil moisture contents were measured until 120 cm depth with a neutron meter in every other day. Irrigations were initiated when 35-40% of available moisture was depleted. Plant efficient root depth was taken as 60 cm [10].

Irrigation program was created by applied different portions of depleted moisture in plant root region. A total of 6 different seasonal irrigation levels were considered in this study. Irrigation treatments were arranged as: 100% full irrigation ( $I_{100}$ ), 20% deficit ( $I_{80}$ ), 40% deficit ( $I_{60}$ ), 60% deficit ( $I_{40}$ ), 80% deficit ( $I_{20}$ ) and 100% deficit ( $I_0$ ).

Seeds were sown on 5 May 2015 manually and harvest was performed on 24 August 2015. Irrigation programs were initiated on 19 June 2015. The statistical analyses were conducted using the SAS program.

## 2.1. Plant Physiological Parameters

**Leaf Water Potential (LWP):** Leaf water potential measurements were performed over at least 3 leaves from each treatment in two-week periods with pressure chamber device. Measurements were performed over healthy and fully developed leaves. Leaf stalk was cut and leaf was placed in pressure chamber. Then the pressure reading was performed from the manometer when water discharge was observed from the cut section and the value was recorded as LWP. To see daily variations in LWP values of treatments, measurements were performed 3 times between the hours 08:00-18:00 in 2 hour intervals.

**Leaf Chlorophyll and Carotenoid Content:** Leaf samples were transported to laboratory in cool boxes and their chlorophyll-a, chlorophyll-b and total carotenoid contents were determined from whole pigment extracts with UV-VIS Spectrophotometric method [11] in two-week periods. Newly harvested leaves initially were placed into liquid nitrogen and then they were cooled and cut into small pieces. From these cut samples, 5 mg tissue sample was taken and placed into test tubes. The tubes were then supplemented with 100  $\mu$ l distilled water and hydrated for 10 minutes. After hydration, 8.0 ml 96% ethanol solution was added and resultant solutions were shaken. Tubes were wrapped with aluminium foils and incubated in a fume hood overnight at room temperature. In the next day, samples were again shaken and particle sedimentation was provided. The liquid portion was then subjected to liquid spectrophotometer readings at 470, 648.6 and 664.2 nm wave lengths. Chlorophyll-a ( $K_a$ ), Chlorophyll-b ( $K_b$ ), total chlorophyll ( $K_{a+b}$ ) and total carotenoid ( $K_{x+c}$ ) contents were calculated with the following equations:

$$K_a = \frac{(13.36D_{664.2} - 5.19D_{648.6}) \times 8.1}{DTW};$$

$$K_b = \frac{(27.43D_{648.6} - 8.12D_{664.2}) \times 8.1}{DTW}$$

$$K_{a+b} = \frac{(5.24D_{664.2} + 22.24D_{648.6}) \times 8.1}{DTW};$$

$$K_{x+c} = \frac{(4.785D_{470} + 3.657D_{664.2} - 12.76D_{648.6}) \times 8.1}{DTW}$$

All units in above equations are in (mg g<sup>-1</sup> DTW).  $D_{648.6}$  = 648.6 nm wave length reading,  $D_{664.2}$  = 664.2 nm wave length reading,  $D_{470}$  = 470 nm wave length reading, DTW = Dry Tissue Weight (mg) [11].

## 3. RESULTS AND DISCUSSION

Throughout the growing season of pumpkin seed plants, 2 emergence irrigations 8 programmed irrigations were performed (a total of 10 irrigations). The amount of irrigation water applied to each treatments ( $I_0$ ,  $I_{20}$ ,  $I_{40}$ ,  $I_{60}$ ,  $I_{80}$  and  $I_{100}$ ) was respectively measured as 24, 71, 118, 165, 211 and 258 mm.

The LWP values of pumpkin seed plants at different irrigation water levels are presented in Figure 1.

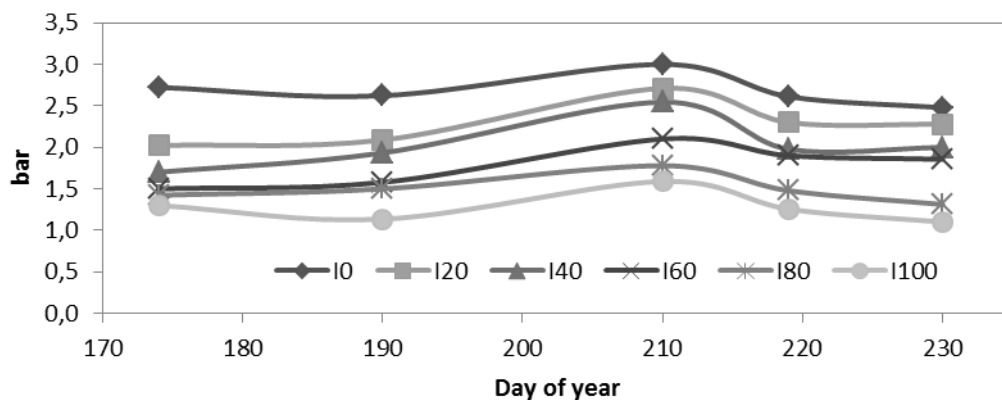

Figure 1. Variation of LWP with different irrigation treatments

As seen in Figure 1, LWP values increased with increasing water stress exerted on plants. The greatest LWP value was observed in I<sub>0</sub> treatment with 2.7 bar and the smallest value was observed in I<sub>100</sub> treatment with 1.3 bar. Since there aren't any previous studies on water stress in pumpkin seed plants, present results were able to be compared with the results of studies carried out with other plants. [12] reported increased LWP values with increasing water stress melon, [2] reported similar findings for beans, [3] for cherry and [13] for cotton.

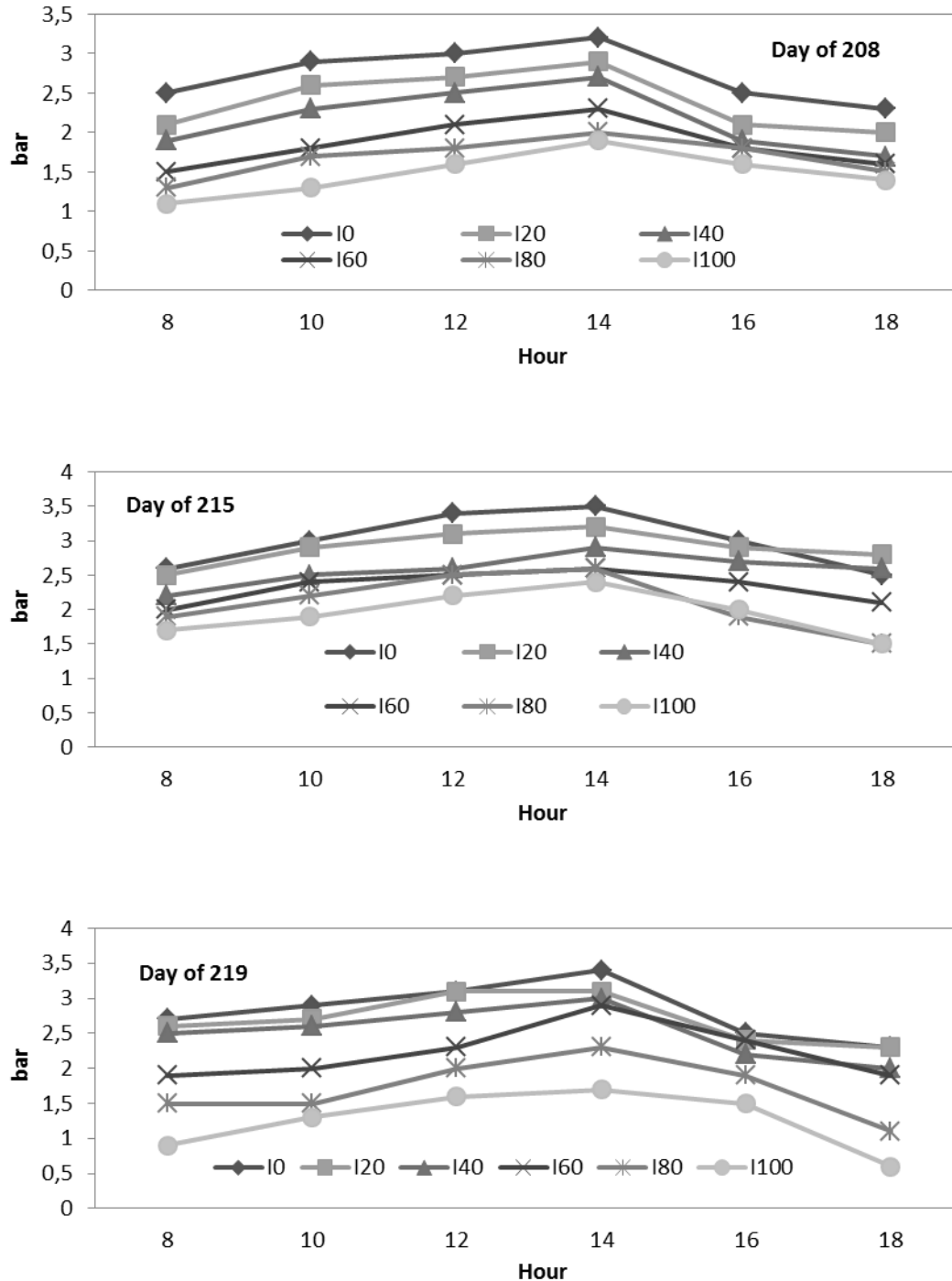

Figure 2. Hourly variations in LWP values

To see daily variations in LWP values of treatments throughout the growing season, measurements were performed 3 times between the hours 08:00-18:00 in 2 hour intervals (Figure 2). As seen in Figure 2, LWP values were at the lowest levels in all treatments during the morning hours. The greatest value was measured at 14:00 because of increased transpiration through increased temperature and decreased relative humidity at noon hours.

Chlorophyll and carotenoid contents of pumpkin seed plants under different irrigation water levels are provided in Table 7.

Table 7. Chlorophyll and carotenoid contents of treatments

Treatments	I <sub>0</sub>	I <sub>20</sub>	I <sub>40</sub>	I <sub>60</sub>	I <sub>80</sub>	I <sub>100</sub>
Ka*	871.00b	1038.70ab	998.88ab	1012.86ab	1081.13a	1121.25a
Kb	358.14	379.17	355.08	354.96	422.13	429.61
Ka+Kb (total chlorophyll)*	1229.15c	1343.20abc	1353.97abc	1367.83bc	1503.26ab	1550.85a
Kx+c (carotenoid)**	341.08c	386.32b	347.39c	386.078b	412.52a	411.36a

\*: significant at 5% level, \*\*: significant at 1% level

While different irrigation treatments created significant differences in chlorophyll-a, chlorophyll- a+b and carotenoid contents, they did not create any significant differences in chlorophyll-b content of plants (Table 8-14).

Table 8. Effects of irrigation levels on chlorophyll-a K<sub>a</sub> contents

Sources	SD	Sum of Squares	Mean of Squares	F
Block	2	17649.338	8824.669	1.46ns
Irrigation level	5	110751.697	22150.339	3.66*
Error	10	60541.617	6054.162	
General	17	188942.651		

ns: non-significant \*: significant at 5% level

Table 9. Duncan test groups for carotenoid K<sub>a</sub>

Irrigation Treatments	Mean
I <sub>0</sub>	871.010 b
I <sub>20</sub>	998.740 ab
I <sub>40</sub>	998.880 ab
I <sub>60</sub>	1012.860 ab
I <sub>80</sub>	1081.130 a
I <sub>100</sub>	1121.250 a

Table 10. Effects of irrigation levels on chlorophyll-b K<sub>b</sub> contents

Sources	SD	Sum of Squares	Mean of Squares	F
Block	2	6322.066	3161.033	0.78ns
Irrigation level	5	21548.225	4309.645	1,06ns
Error	10	40773.608	4077.361	
General	17	685643.899		

ns: non-significant

Table 11. Effects of irrigation levels on total chlorophyll (K<sub>a+b</sub>) contents

Sources	SD	Sum of Squares	Mean of Squares	F
Block	2	39867.682	19933.841	1.79ns
Irrigation level	5	211333.021	42266.604	3.79*
Error	10	111426,962	1142.696	
General	17	362627.665		

ns: non-significant \*: significant at 5% level

Table 12. Duncan test groups for total chlorophyll (K<sub>a+b</sub>) contents

Irrigation Treatments	Mean
-----------------------	------



I <sub>0</sub>	1229.150 c
I <sub>20</sub>	1392.980 abc
I <sub>40</sub>	1353.970 abc
I <sub>60</sub>	1322.260 bc
I <sub>80</sub>	1503.260 ab
I <sub>100</sub>	1550.850 a

Table 13. Effects of irrigation levels on carotenoid ( $K_{x+c}$ ) contents

Sources	SD	Sum of Squares	Mean of Squares	F
Block	2	98.607	49.303	0.45ns
Irrigation level	5	14078.212	2815.642	25.89**
Error	10	1087.567	108.757	
General	17	15264.385		

ns: non-significant \*\*: significant at 1% level

Table 14. Duncan test groups for carotenoid ( $K_{x+c}$ ) contents

Irrigation Treatments	Mean
I <sub>0</sub>	341.08 c
I <sub>20</sub>	386.32 b
I <sub>40</sub>	347.39 c
I <sub>60</sub>	386.08 b
I <sub>80</sub>	412.52 a
I <sub>100</sub>	411.36 a

Chlorophyll and carotenoid contents increased with increasing irrigation water levels. The lowest total chlorophyll content was observed in I<sub>0</sub> treatment and the greatest value was seen in I<sub>100</sub> treatment. While the lowest carotenoid content was observed in I<sub>0</sub> treatment, the greatest value was seen in I<sub>80</sub> treatment. Similar increasing chlorophyll and carotenoid contents with increasing irrigation levels were also reported for other plants in previous studies ([3], [4] and [6]).

#### 4. CONCLUSIONS

In present study, effects of different irrigation water levels through drip irrigation on some physical characteristics of pumpkin seed plants grown in center Anatolia region of Turkey were investigated. Decreasing leaf water potential, chlorophyll and carotenoid contents were observed with increasing water deficit levels.

Chlorophyll and carotenoid contents decreased with increasing water deficits. However, there were not any significant differences between full irrigation (I<sub>100</sub>) and 20% water deficit (I<sub>80</sub>) treatments. Increasing water stress levels resulted in increasing leaf water potential (LWP) values. While the greatest LWP value was observed in I<sub>100</sub> treatment with 2.7 bar, the lowest value was seen in I<sub>0</sub> treatment with 1.3 bar. It was concluded in this study that full irrigation should be used in pumpkin seed plants for high quality and quantity yields. Chlorophyll and carotenoid contents and LWP values can be used as water stress indicators in pumpkin seed plants.

#### ACKNOWLEDGMENT

The authors would like to thank the Turkish Scientific and Technical Research Council (TUBITAK) and University of Erciyes for financial support to the project of TOVAG-114O225 and BAP FDK-2015-5875, respectively.

#### REFERENCES

- [1] J.S. Boyer, Plant Productivity and Environment Science, 218:443-448, 1982.
- [2] E.S. Köksal, H. Üstün and A. İlbeyi, Bodur yeşil fasulyenin sulama zamanı göstergesi olarak yaprak su potansiyeli ve bitki su stres indeksi sınır değerleri. U.Ü. Ziraat Fakültesi Dergisi, 24 (1): 25-36, 2010.
- [3] H. Kırnak and M.N. Demirtaş. Su Stresi Altındaki Kiraz Fidanlarında Fizyolojik ve Morfolojik Değişimlerin Belirlenmesi, Atatürk Üniv. Ziraat Fak. Derg. 33(3), 265-270, 2002.
- [4] G. Çamoğlu, L. Genç and Ş. Aşık, Tatlı Mısırdaki (Zea mays saccharata Sturt) Su Stresinin Fizyolojik ve Morfolojik Parametreler Üzerine Etkisi, Ege Üniv. Ziraat Fak. Derg. 48(2):141-149, ISSN 1018-8851, 2011.
- [5] P.S. Kramer and J.S. Boyer, Water Relations of Plants and Soils. San Diego Academic Press, 1995.
- [6] E.S. Köksal, Sulama Suyu Düzeylerinin Şeker Pancarının Verim, Kalite ve Fizyolojik Üzerindeki Etkisinin, İnfrared Termometre ve Spektrodijometri ile Belirlenmesi, Ankara Üniv. Fen Bilimleri Enst. Doktora Tezi, 2006.
- [7] R.T. Fernandez, R. L. Perry and J.A. Flore, Drought Response of Young Apple on Three Rootstocks II. Gas Exchange, Chlorophyll Fluorescence, Water Relations and Leaf Abscisic Acid, J. Amer. Soc.Hort.Sci, 122(6):841-848, 1997.
- [8] Y. Karimi, S.O. Prasher, H. McNairn, R.B. Bonnell, P. Dutilleul and P.K. Goel, Discriminant Analysis of Hyperspectral Data for Assessing Water and Nitrogen Stress in Corn, Trans. Of the ASAE,48(2):805-813, 2005.
- [9] J. Keller, R.D. Bliessner, Sprinkle and Trickle irrigation. Chapman and Hall, 115 Fifth Avenue, New York, NY 10003, 1990.
- [10] R.G. Allen, L.S. Pereira, D. Raes, M. Smith, Crop Evapotranspiration-Guidelines for Computing Crop Water Requirements, Irrigation and Drain, Paper No.56.FAO, Rome, Italy, p.300, 1998.

[11] H.K. Lichtenthaler, "Chlorophylls and carotenoids: pigments of photosynthetic membranes", *Methods Enzymol* 148: 350–382, 1987.

[12] S. Kıran, F. Özkay, Ş. Ellialtıođlu and Ş. Kuşvuran, Kuraklık stresi Uygulanan Kavun Genotiplerinde Bazı Fizyolojik Deđişimler Üzerine Araştırmalar, *Toprak Su Derg.* 3(1): 53-58, 2014.

[13] F. Maya, Farklı su ve Gübre Sistemlerinde Pamuk Bitkisinde Yaprak su Potansiyelinin Deđişimi, Çukurova Üniv. Fen Bilimleri Enst. Tarımsal Yapılar ve Sulama A.B.D. Yüksek Lisans Tezi, 2007.

# Socio-psychological issues and their consequence on farmers' behavioural intention towards sustainable practices

Woldegebrial Zewel<sup>1</sup>, Guido Van Huylenbroeck<sup>2</sup>, GirmayTesfay<sup>1</sup>, Stijn Speelman<sup>2</sup>

---

## Abstract

*This study investigates smallholder farmers' behavioural intention towards two sustainable practices: minimum tillage and row planting. In research the impact of socio-psychological issues on intentions has remained relatively unexplored. Our work uses the decomposed theory of planned behaviour as a theoretical framework. The findings reveal that attitudes and normative issues positively explain farmers' intention to adopt sustainable practices. Perceived control also has a positive and significant effect on the intention to apply minimum tillage. Besides, perceived usefulness, social networks, and perceived easiness are significant predictors of farmers' attitudes. Furthermore, social capital and training are factors that positively affect the normative issues, which in turn also positively mediate the relationship between training and social networks and behavioural intention. Finally, neither the perceived resources nor media seems to significantly affect farmers' intentions. To conclude, this paper confirms that social networks, personal efficacy, training and perceived usefulness play significant roles in adopting sustainable practices in the current farming systems.*

**Keywords:** *Decomposed theory of planned behaviour, information, intention, Smallholder farmers, structural equation model, sustainable practice,*

---

## 1. INTRODUCTION

Sustainable practices are expected to improve farm productivity, and enhance food security [1] as well as to improve soil fertility, reduce risks of drought, reduce erosions, and to maintain biodiversity, environmental sustainability and agroecosystem resilience [2]. The practices involve a decrease in the use of inputs that are potentially harmful to the environment while maintaining the competitiveness and economic viability of agriculture [3].

In spite of these advantages, the adoption of sustainable practices in low-income countries has still remained below the expectation. In literature, several demographic and socioeconomic factors were raised to explain the low adoption [1], [2]. However, there is still a lack of clear evidence to understand why farmers voluntarily adopt sustainable practices [4]. This indicates the need for further in-depth research on how farmers can be encouraged to use agricultural practices that could enhance productivity and at the same time sustain the ecosystem resilience.

Several previous studies primarily focused on how demographic factors, economic resources, and biophysical factors affect adoption of sustainable practices and only some studies considered perceptions to account for socio-psychological influences and access to the extension system to measure the impact of information sources. However, most of them overlook cognitive, social and psychological factors [5]. They didn't consider the characteristics of the agricultural practices and socio-psychological issues [6], [7]. These studies might not sufficiently capture psychological factors and social influences and alternative information sources.

Therefore, this paper has three objectives. First, it identifies the main sources of agricultural information that farmers currently use. Second, the paper determines the level of attitudes and intentions of smallholder farmers to use sustainable practices on their plots in the future. Last, we investigate the influence of attitudes, normative issues and perceived controls on the behavioural intention of small farmers to adopt these practices.

## 2. THEORETICAL AND CONCEPTUAL FRAMEWORKS

The theory of reasoned action assumes that human behaviour is under the full volitional control. It postulates that intention, which is captured by two motivational factors, attitudes, and subjective norms plays a central role to perform a given human behaviour and adoption decision [8]. This implies that farmers can consider the consequences and the aligned norms of their actions before they decide whether or not to engage in a given behaviour.

Later Ajzen criticised the assumption of the full-volitional control because there are some that rely on external factors [9]. Following this, Ajzen proposed the theory of planned behaviour, which added perceived control to intention components.

---

<sup>1</sup>. Corresponding author: Department of Natural Resource Economics and Management, Mekelle University, P. O. Box 1198, Mekelle, Ethiopia. [woldezew@yahoo.com](mailto:woldezew@yahoo.com), Mekelle University, Department of Natural Resource Economics and Management, Mekelle, Ethiopia  
<sup>2</sup> Ghent University, Department of Agricultural Economics, Ghent, Belgium

Accordingly, intention becomes a weighted function of attitudes, subjective norms and perceived controls. Both perceived control and intention also explain the adoption behaviour (usage) of technological innovations and sustainable practices.

The theory of planned behaviour was later criticised for its monolithic structure of belief by Taylor and Todd [10]. The cognitive component of belief structure can't be organised into a single conceptual unit. As a result, they proposed the decomposed theory of planned behaviour and further decomposed the attitudinal belief into a relative advantage, perceived security and perceived complexity, and the perceived behavioural control into facilitating conditions and self-efficacy.

In our study the decomposed theory of planned behaviour is used as our theoretical basis to explain farmers' intention to use sustainable practices. Farmers' intention to adopt sustainable practices is explained by three dimensions: attitudes, perceived controls and normative issues. We further decompose attitudes into perceived usefulness capturing the perception of farmers with regards to the positive contribution of the sustainable practices to the performance of outcomes like yield, the perceived easiness which covers the degree of farmer's perception on simplicity of the practices to understand, learn and adopt, and finally perceived compatibility, which is the degree to which practices fit with a farmer's previous experience and existing traditional values.

The perceived control indicates the beliefs of farmers whether there are factors (obstacles and opportunities) that affect their adoption decisions. We decompose this into perceived resource and personal efficacy. The perceived resource concerns with the degree of perception of the farmers on how economic resources and facilities (money, labour, land, and time) affect behaviour and then may facilitate or impede the adoption of sustainable practices whereas personal efficacy is about a farmer's belief and evaluation on own skills, competencies, knowledge, and capabilities to perform the practices. We further decompose normative issues that indicate the degree to which a farmer believe in the influence of reference groups, and information channels on the adoption decision behaviour into four structures<sup>1</sup>.

### 3. MATERIALS AND METHODS

This study was conducted in Atsbi-Wemberta district, in the north-east of the Tigray region in Ethiopia. This is a drought-prone area. After classification of the 18 administrative villages in the district based on the agro-ecological zone, one village (Eira) was randomly selected from the warm temperate zone (1500-2300 meters above sea level) and five villages (Hayelom, Michael Emba, Habes, Felege Weyni and Ruba Feleg) from the temperate zone (2300-3069 meters) using a lottery method. From the villages, 350 farmers were randomly selected using proportional and systemic sampling methods.

With regard to sustainable practices, in consultation with the extension workers and development practitioners, we identified many practices like soil and water conservation, agroforestry, biological control, crop rotation, row planting, crop diversification, compost application, farmyard manure, minimum tillage, area enclosure, zero-grazing and weed management. We categorised these sustainable practices as (a) commonly applied or (b) barely adopted or only introduced recently in the district. The latter category includes for instance, biological control of pests and diseases, biodegradable pots, row planting and minimum tillage. Therefore, row planting and minimum tillage were selected to explore socio-psychological influence on farmers' intentional adoption decision towards these practices.

The data was collected from the sample farmers by using a survey method. The final version of the questionnaire includes information sources, social variables, and psychological factors. The study uses a principal component analysis with iteration and oblique rotation to determine small latent variables with homogenous and common structure from the large dimension and heterogeneous observed indicators in the questionnaire. Linear structural equation modelling with maximum likelihood estimation is applied to estimate the potential causal dependency between the derived latent variables.

The latent variables are measured by observed statements. We use a Bartlett principal component analysis to determine the statements underlying the latent variables or factors with a common structure. About 50 statements are used in the survey both for row planting and minimum tillage. The statements are loaded into 13 diverse factors with Eigenvalue one and above, this explained about 73% of the available variance in minimum tillage and 82% for row planting. The intention, attitude, normative issue, technical training, social capital and personal efficacy factors are respectively loaded by six, four, five, four, five and five observed statements while other factors are loaded each by three statements. These variables are liable, valid and normally distributed.

### 4. RESULTS AND DISCUSSION

#### 4.1. Agricultural Information Dissemination Strategies: Accessibility, Confidence, And Preference

This section aims to identify promotional campaigns (information sources or dissemination strategies) that are utilised by the Ethiopian government to promote the adoption of improved technologies and sustainable practices. We grouped the sources of information into four groups: media influence, extension service, technical training and social capital.

---

<sup>1</sup>. *Media influence* or media report includes the overall influence from formal media devices such as television, radio broadcast, mobiles, telephone, newspapers, magazine and other appliances. *Technical training* is the pressure and influence from practical experience sharing, short-term training session, workshops, agricultural field-day, on-farm demonstration and exposure visits. *Extension service* is the degree of influence on adoption behaviour of a farmer from consulting agricultural advisory experts, development agents or extension workers and trust on this information. This is all about technical advice and support from agricultural advisory services. *Social capital* or interpersonal contact or social influence represents the extent of influences of significant referent groups on behaviours, example, friends, neighbours, families, relatives, communities, children schooling, traditional group, and rural associations.

Table 1 reports the responses of the respondents. About 12% and 30% of respondents have obtained agricultural information from mass media and training, respectively. About 84% of them have also acquired information from extension workers and agricultural advisory experts. This shows that about 90% of respondents have no access to television, radio, and other media devices. Also about 70% had no training about sustainable practices.

We asked respondents to rate their level of confidence for the different promotional campaigns on a three-point response scale (low, moderate and high). Half of the respondents had a high confidence in information from mass media and training whereas the corresponding figure for social networks was about 8% and for agricultural advisory services was about 17%. The percentage of respondents who had a low confidence in promotional campaigns was about 57% for the social capital, followed by extension service (47%), media reports (15%) and training (11%).

Understanding farmers' preference to these information strategies is also a pre-eminent tool to design information-based campaigns to promote sustainable agricultural practices. We asked respondents for their preference regarding these alternatives based on, for example, easiness, reliability, prior experience, resource saving, and effectiveness. The scale used to measure preference ranged from 1 (least preferred) to 4 (most preferred). Media and training were the most preferred sources of agricultural information for about 35% and 42% of respondents, respectively. About 10% and 15% of the respondents preferred social networks and expert advice as sources of agricultural information in the future.

Table 1. Agricultural information: source, accessibility and confidence by farmers (%)

Sources of information	Access to		Level of confidence			Preference		
	Freq.	%	Low	Moderate	High	Freq.	%	Mean
Media influence	41	12	15	37	48	117	33	3.5
Social capital	350	100	57	35	8	35	10	2.4
Extension service	293	84	47	36	17	51	15	2.7
Technical training	105	30	11	24	65	147	42	3.7

## 4. 2. Smallholder Farmers' Attitudes And Intentions To Use Sustainable Practices

This section aims to understand the attitudes and intentions of smallholders towards minimum tillage and row planting. Based on a principal component analysis, six and four observed statements were respectively loaded to intentions and attitudes. The attitude/intention of farmers classified as farmers who have positive, undecided/undefined and negative. Table 2 presents smallholder farmers' attitudes and intentions to use row planting and minimum tillage.

About 61% and 74% of the respondents have a positive attitude towards adoption of minimum tillage and row planting, respectively. The percentage of respondents who has a negative attitude towards both practices is about 8%. The other farmers have a neutral attitude towards the practices.

Similarly, about 54% of respondents have a positive intention to use minimum tillage and about 72% for row planting. About 20% and 39% of the respondents have a neutral or undecided intention for row planting and minimum tillage, respectively. About 8% of respondents have a negative intention for row planting and about 3% for minimum tillage.

Table 2. Farmers attitudes and intentions toward adopting sustainable practices

Variable	Scales	Row planting practices				Minimum tillage practices				$\chi^2$
		Mean	Freq	%	Rank	Mean	Freq	%	Rank	
Attitude	Positive	0.80	258	74	1	0.68	214	61	1	0.025**
	Neutral	0.48	62	18	2	0.48	110	31	2	
	Negative	0.24	30	8	3	0.31	26	8	3	
Intention	Positive	0.77	252	72	1	0.68	189	54	1	0.019***
	Neutral	0.49	69	20	2	0.49	135	39	2	
	Negative	0.33	29	8	3	0.30	26	7	3	

Note: \*, \*\* and \*\*\* shows the test is statistically significant at 10%, 5%, and 1% levels, respectively.

## 4. 3. Socio-Psychological Effects On Smallholder Farmers' Behavioural Intention

In this section, we examine factors affecting farmers' intention towards row planting and minimum tillage using the robust maximum likelihood estimation method of structural equation model. The behavioural intention is explained by three different variables, namely, attitude, perceived control and normative social norms. The finding of the structural equation model that includes the path coefficients, their significance, and explanatory power is depicted by Table 3.

The attitudes and normative issues are statistically significant predictors that influence the intention of farmers to adopt both practices. However, the perceived control failed to reach statistical significance for row planting. Respondents who have positive and high attitudes have higher intentions to adopt minimum tillage and row planting compared to other farmers. The normative issues enhance intention of respondents to adopt both practices. The perceived control has a negative significant influence on the intention of farmers to adopt minimum tillage.

Table 3 shows perceived easiness, perceived usefulness, social influence, perceived compatibility, and technical training that predict attitudes, which capture about 83% of the available variance of attitude for row planting and 80% for minimum tillage.

These variables are positive and significant determinants of the attitudes towards both practices, except the perceived compatibility which has a negative effect on the attitude towards minimum tillage. Farmers who have technical training and strong social networks have favourable and positive attitudes towards sustainable practices.

The normative issue is another factor in the intention model. Media influence, extension service, technical training and social capital explained this variable. It captures about 70% of the available variance in the normative issue for row planting and 89% for minimum tillage. Training and social capital have positive significant effects on the normative issues for both practices. Use of media as a main source of information has an insignificant effect on farmers' normative issues to adopt both practices. Thus, training and social capital can help farmers to reduce uncertainties they have on the practices and evaluate their decision-making critically.

Extension services are hypothesised to positively influence farmers' normative issue towards sustainable practices because the agricultural advisory services build positive and favourable normative beliefs [11]. However, we find that extension services have a negative significant effect on normative issues of minimum tillage. Farmers who have frequently acquired information and guidance from agricultural advisories have negative normative beliefs and are unlikely to use minimum tillage. Further study is required to understand this negative effect on normative issues in detail.

Perceived control that shows the influence of internal and external forces is explained by personal efficacy and perceived resources. Both variables are able to predict 72% for row planting and 67% for minimum tillage. Personal-efficacy is a positive significant determinant of the perceived control for both practices. The path from perceived resources to perceived control in minimum tillage is negative and statistically significant although it is found to be statistically insignificant in row planting. This indicates that the presence of barriers, for example, shortage of family labour and lack of money might retard the adoption of minimum tillage.

Table 3. Standardised coefficients of the variables for both sustainable practices (structural model)

Model	Variable	Row planting practices			Minimum tillage practices		
		Coeff.	P-value	R2	Coeff.	P-value	R2
intention	attitude	0.97	0.000***	0.81	0.05	0.031**	0.79
	normative issue	0.03	0.046**		0.45	0.000***	
	perceived control	0.01	0.651		-0.08	0.052*	
attitude	perceived usefulness	0.62	0.000***	0.83	0.47	0.000***	0.80
	perceived compatibility	0.02	0.113		-0.23	0.000***	
	perceived easiness	0.20	0.000***		0.16	0.000***	
	social capital	0.19	0.003***		0.21	0.000***	
	technical training	0.13	0.049**		0.01	0.125	
	media influence	0.11	0.107		0.06	0.340	
normative issue	technical training	0.27	0.000***	0.70	0.07	0.036**	0.89
	extension service	0.04	0.455		-0.13	0.049**	
	social capital	0.56	0.000***		0.11	0.046**	
perceived control	personal efficacy	0.85	0.000***	0.72	0.09	0.083*	0.67
	perceived resources	0.01	0.468		0.03	-0.059*	

## 5. CONCLUSION REMARKS

This study examines how socio-psychological factors and information sources affect smallholder farmers' intention to adopt minimum tillage and row planting using a randomly selected sample of 350 farmers. The decomposed theory of planned behaviour is used as a theoretical framework, and the data is analysed by a linear structural equation model. The findings reveal that media reports and training are considered as reliable sources of agricultural information, whereas the information from social capital and extension services is considered less credible. Positive attitudes and favourable normative issues are found to lead to stronger intention to perform sustainable practices. The greater the perceived control, the stronger is the farmers' intention to adopt minimum tillage practices although the perceived control is an insignificant determinant of behavioural intention for row planting.

The finding shows that social capital, extension service, personal efficacy, and training are the main drivers for normative issues while for attitude main drivers are attributes of the practices along with social capital and training. Attitude mediates the positive effects of perceived usefulness and perceived easiness on farmers' intention for sustainable practices. The normative issues also mediate the positive and significant effects of training and social capital for sustainable practices. However, the pressure of mass media and extension services have no indirect effect on farmers' behavioural intention. The perceived control is also found to be an insignificant mediator for the effects of personal efficacy and perceived resource conditions to intention of the smallholder farmers. Thus, attributes of the practices and alternative information are essential factors for smallholder farmers to have positive attitude and intention towards sustainable practices.

## ACKNOWLEDGMENT

The research cost of this study is supported by Ghent University, Mekelle University, and Open Society Foundations-Africa Climate Change Adaptation Initiative (ACCAI). We would like to express our gratitude the organisations.

**REFERENCE**

- [1] M. Kassie, M. Jaleta, B. Shiferaw, F. Mmbando, and M. Mekuria, "Adoption of interrelated sustainable agricultural practices in smallholder systems: Evidence from rural Tanzania," *Technol. Forecast. Soc. Change*, vol. 80, pp. 525–540, 2013.
- [2] C. Mbow, P. Smith, D. Skole, L. Duguma, and M. Bustamante, "Achieving mitigation and adaptation to climate change through sustainable agroforestry practices in Africa," *Curr. Opin. Environ. Sustain.*, vol. 6, pp. 8–14, 2014.
- [3] A. Wezel, C. David, A. Ferrer, A. Letort, S. Féret, J. Peigné, J. F. Vian, and F. Celette, *Agroecological practices supporting the provision of goods and services in agriculture Examples from France and Europe*. ISaralyon, 2014.
- [4] M. Yazdanpanah, D. Hayati, S. Hochrainer-Stigler, and G. H. Zamani, "Understanding farmers' intention and behavior regarding water conservation in the Middle-East and North Africa: A case study in Iran," *J. Environ. Manage.*, vol. 135, pp. 63–72, 2014.
- [5] C. G. Martínez-García, P. Dorward, and T. Rehman, "Factors influencing adoption of improved grassland management by small-scale dairy farmers in central Mexico and the implications for future research on smallholder adoption in developing countries," *Livest. Sci.*, vol. 152, no. 2–3, pp. 228–238, 2013.
- [6] E. Wauters and E. Mathijs, "The adoption of farm level soil conservation practices in developed countries: a meta-analytic review," *Int. J. Agric. Resour. Gov. Ecol.*, vol. 10, no. 1, pp. 78–102, 2014.
- [7] K. M. Foley, "Examining the voluntary adoption of agricultural conservation practices in northern Malheur Country, Oregon," Master thesis, Oregon State University, 2013.
- [8] M. Fishbein and L. Ajzen, *Belief, attitude, intention, and behaviour: an introduction to theory and research*. Reading, MA: Addison-Wesley, 1975.
- [9] I. Ajzen, "The theory of planned behavior," *Organ. Behav. Hum. Decis. Process.*, vol. 50, pp. 179–211, 1991.
- [10] S. Taylor and P. Todd, "Decomposition and crossover effects in the theory of planned behavior: A study of consumer adoption intentions," *Int. J. Res. Mark.*, vol. 12, pp. 137–155, 1995.
- [11] U. N. Opara, "Agricultural information sources used by farmers in Imo State, Nigeria," *Inf. Dev.*, vol. 24, pp. 289–295, 2008.

# Effects of Nutrition Education on General Health and Nutritional Status of Pregnant Women

Meltem Soylu<sup>1</sup>

---

## Abstract

Nutrition education improves maternal nutrition and reduces the risk of poor health outcomes in both mothers and their children. The relationship between maternal nutrition education and mother's nutritional knowledge score, dietary habits, food consumption and health status (hemoglobin, hematocrit, blood pressure and body weight gain) were the subject of investigation in this study. This study has been conducted by random sampling on 150 low income pregnant women between the ages of 18-35, in intervention and control groups. Data was collected at an initial interview and again at a final interview after two nutrition education programs. There were significant increases in the nutritional knowledge score and mean intake of calcium, iron, vitamin A and weight gain in the intervention group ( $p < 0.05$ ), also increases on mean intake of energy, protein and vitamin C. Hemoglobin and hematocrit levels in the intervention group did not appear to be influenced by the nutrition education. The results indicate that nutrition counseling during pregnancy can improve dietary intake and maternal weight gain.

**Keywords:** nutrition, nutritional education, pregnant.

---

## 1. INTRODUCTION

Optimal maternal nutrition during pregnancy and lactation is vitally important to the health of mother and infant. Nutritional needs rise during pregnancy in response to the metabolic demand of the developing embryo as well as to changes in maternal physiology [1]. An association exists between health of fetus and adequate and balanced maternal nutrition during pregnancy, which is a natural event for every woman [2]. The nutritional status of the mothers in pre and postnatal periods is of great importance for the health of both the mother and their unborn babies thus maternal nutrition becomes a strong underlying determinant for the public health. The pre- and early postnatal phases are the periods during which changes to nutritional status may have the most detrimental impact. Furthermore, a large evidence base confirms that direct effects of maternal nutritional status on offspring adult health can occur. If birth weight and intrauterine growth restriction are assumed as proxy indicators for maternal nutrient supply [3].

When the maternal nutrition is inadequate and unbalanced during gestational period, the baby's needs are provided from the own tissues of mother. The risk incurred by the mother due to inadequate and unbalanced nutrition increases with the poor socio-economic and health conditions. If the increased energy and nutrient requirements are not met, various diseases, especially anemia, osteomalacia and decreased resistance to infection can occur in the mother. In addition, the incidence of complications in pregnancy and birth increases 3-4 folds [1,2,3,4]. There is a strong association between low birth weight and intrauterine growth restriction, and later: insulin metabolism; T2DM; central adiposity; abnormal lipid metabolism; obesity; hypertension; cardiovascular diseases (CVD); increased risk of death from ischaemic heart disease; and renal disease [5]. The malnutrition due to inadequate and unbalanced nutrition during gestation has extremely important negative effects of on intrauterine growth. Stillbirth, preterm birth and low birth weight are among commonly encountered problems [2].

Maternal diet during this period is an important criterion for the outcome of the pregnancy. Daily energy and nutrient items for pregnant women and nursing mothers should individually be planned to meet their physiological requirements, to keep the nutrition stores in balance, to ensure normal growth and development of the fetus and to ensure adequate milk secretion during lactation [1, 4].

When maternal weight gain is insufficient during pregnancy, the risk of low birth weight is increased; therefore, diet should be managed to ensure that energy intake is neither excessive nor deficient. Energy and nutrient requirements of pregnant and lactating women are higher than normal women. Physiologic changes during pregnancy alter nutritional requirements. Plasma volume expands nearly 50% during pregnancy. Total mass of red blood cells increases about 33% over pre-pregnancy levels. Basal metabolic rate is increased by 15% to 20% toward the end of gestation. These changes require increased intake of energy, nutrients, and fluid [1].

Studies conducted in our country have revealed that the majority of pregnant women change the nutritional habits during gestation, but that is not in the desired manner, i.e. in accordance with adequate and balanced nutrition principles. It has been indicated that malnutrition problems are due to lack knowledge rather than economic difficulties. Unfortunately, in our country,

---

<sup>1</sup>Corresponding author: Nuh Naci Yazgan University, Faculty of Health Sciences,



correct and effective nutrition education services during pregnancy cannot be provided to a large portion of this risk group. Since the increasing the awareness of pregnant women for nutrition during gestation and lactation is of importance for achieving healthy generations, this study was performed to determine the influence of the nutrition education given to pregnant women with different frequencies at different stages of gestation on the nutritional status and overall health status in comparison with the pregnant women receiving no education [6].

The relationship between maternal nutrition education and mother's nutritional knowledge score, dietary habits, food consumption and health status (hemoglobin, hematocrit, blood pressure and body weight gain) were the subject of investigation in this study.

## **2.MATERIAL AND METHODS**

This experimental and investigation study was initiated with the permission of Ministry of Health. All participants provided written informed consent.

### **2.1.Participant and Study Design**

This study was started with 173 pregnant women giving maximum two live births or less and aged between 18-35 who admitted to Pregnancy Clinic of Maternal and Child Health and Family Planning Center located in Çubuk, Ankara. However, the study has been completed with 150 pregnant volunteers because the 2 women had abortion during the first trimester of pregnancy and, authors could not reach gain to 21 pregnant women after the first interview. The women with chronic diseases such as renal, thyroid, cardiovascular problems and diabetes were excluded from the study.

One hundred and fifty pregnant volunteer women whose gestational age determined according to the last menstrual period were equally divided into six groups as controls and treatments containing 25 participants in each. Group 1 consisted of the participants at their first trimester (in 1-3 months) of pregnancy, Group 2 consisted of the participants at their second trimester (in 4-6 months) of the pregnancy and Group 3 consisted of the pregnant women who were at the third trimester (in 7-9 months) of pregnancy. A control was kept for each group.

### **2.2.Data Collection and Measurements**

A questionnaire consisting of questions that are designed to determine the women's personal information (age, age at marriage, pregnancy history, education and occupation, etc.), nutrition knowledge and dietary behaviors during pregnancy as well as daily food consumption, frequency food intake physical activity status, general health status and awareness of breastfeeding was administered to the participants. Each question was scored as one point. Total score was 38. The scores of 0-12, 13-25 and 26-38 were classified as poor, medium and good respectively.

Heights and weights of pregnant women were measured at the beginning of the study. The measurements were repeated at each meeting in order to determine the weight gain. Weight and height were measured according to the technique by researchers in the clinical scales. The records related to edema, blood pressure, blood and urine tests were obtained from the personal file of participants after the examination by the clinician and nurses. Women's hemoglobin and hematocrit levels were determined with a hematocrit centrifuge by laboratory technician in the center. Dietary intake and physical activity were obtained by the method of keeping a daily record.

Gram values corresponding to practical measures were used to determine the amount of food consumed by the participants [7]. Energy and nutrient values for these nutrients were calculated using food composition tables. The amount of nutrients in a serving of the food consumed by participants was calculated according to the Standards Food Recipes for Institutions [8].

Women in Group 1 were trained twice at their first and second trimesters of pregnancy until the end of pregnancy. Only one nutrition education was given to women in the Group 2 (second trimester) and Group 3 (third-trimester). Pregnant women in the treatment groups were trained face to face for the issues of the impact of the pregnant nutrition on maternal and infant health, food groups, and the amount of the essential nutrients to be consumed during pregnancy, weight gain in pregnancy, iodized salt utilization, protection from anemia and the importance of food preparation and breast-feeding. An illustrated guide prepared for pregnant women was used in education, and a brochure containing the issues given during education was provided to each participant following the training. The same questionnaire was repeated again within 30 days for every woman to detect the changes after nutrition education.

In this study, there are some limitations. First, we studied the small sample size. Large-scale studies are needed on this issue in the future studies. Second, self-reported dietary intake data are likely inaccurate.

### **2.3.Analysis of Data**

Data were analyzed by the Statistical Package for Social Science version 16.0 software (SPSS, Chicago, IL,USA). Kruskal Wallis variance analysis for the differences between groups, Mann-Whitney U test, the Wilcoxon two-sample paired signed rank test for analysis of repeated measurements and Chi square tests for independent variables were performed. When the differences were significant, Bonferroni correction was performed to determine which subgroups are different. The relationship between variables was evaluated with Spearman correlation analysis. P values less than 0.05 were considered as significant [9].

## **3.RESULTS AND DISCUSSION**

All of the pregnant women participating in the study were housewife and the majority of them was primary school graduates. The mean age of the women at first pregnancy were between 19.28 and 20.32. The time between two pregnancies was longer than the required limit of 24 months in the great majority of women participated in the study. The 16% of the women had

consanguineous marriages and the percentage of the families living with their parents were high. Most of the women had routine controls every month and had been examined by a midwife or nurse. The pre-pregnancy BMI (body mass index) of the women was within normal limits. Lack of obesity before pregnancy in the presented study, compared to overall BMI in Turkey, may be due to the lower age of the women participating in the study (Table 1).

Appropriate weight gain during pregnancy is directly related to the baby's birth weight. For women with a baseline BMI below 20, weight gain of 0.5 kg per week during the second and third trimesters is indicated. For overweight women (BMI of 25 to 29.9), weight gain of 0.3 kg per week during the same period is recommended. [10]. Weight gain of more than 1 kg per week at any time is generally excessive [1]. The recommended average weight gains in pregnancy were 0.065 kg/week for 0-10<sup>th</sup> weeks, 0.335 kg/week for 10-20<sup>th</sup> weeks, 0.45 kg/week for 20-30<sup>th</sup> weeks and 0.335 kg/week for 30-40 weeks [11a]. In this study, although, total weight gain of pregnant women varied in each trimester, they gained 12.5 kg  $\pm$  10 % (9 -14 kg) weight totally, approximately 1-1.5 kg per month. Observation of higher ( $p < 0.05$ ) weekly weight gain in women who trained and monitored from the beginning to the termination of the gestation as Ziegler and Filerj's recommended (Table 1) [11]. Strychar et al. (2000) who investigated the effects of psychosocial and lifestyle factors on weight gain of 115 pregnant women during pregnancy, and reported that being under doctor or dietician control improves the weight gain. These authors also observed that women gained insufficient weight when they smoked more but controlled less by clinician or dietitian as well as have less knowledge about weight gain during pregnancy [12].

Antenatal care is one of the most important preventive healthcare and support providing regular check-ups by doctors or midwives for mother and unborn baby [13]. Although, the timing and number of antenatal visits depends on the individual, pregnant women should be monitored by health professionals at least four times [14a].

The physical examination of pregnant women is performed, blood pressure is taken and height and weight are measured, and if it is in accordance with the vaccination calendar, they are vaccinated against tetanus, and education related to pregnancy, labor and the baby is given during routine follow-up. However, a standard training for the principles of nutrition during pregnancy is not included in these applications. Even, medical staffs who have limited nutrition knowledge cannot give enough nutrition education to women. In the presented study, most of the women visited the clinics every month (88% 84%, 84%, 44%, 80%, 76% respectively) and underwent routine examinations (76% 56%, 64%, 48%, 60 %, 52 % respectively).

Maternal anaemia is associated with mortality and morbidity in the mother and baby, including risk of miscarriages, stillbirths, prematurity and low birth weight [15]. 32.4 million pregnant women with anaemia and 0.8 million pregnant women had severe anaemia worldwide in 2011 [16]. Maternal anaemia remains a significant health problem especially in low and middle-income countries. Rahman et al (2016) conducted a systematic review and meta-analysis to estimate the pooled prevalence of anaemia, the association between maternal anaemia and pregnancy outcomes. There were significantly higher risks of low birth weight (12%), preterm birth (19%), and perinatal mortality (18%), in pregnant women with anaemia in low- and middle-income countries [17].

Anemia is a major public health problem that still preserves the severity in Turkey. In a study investigating the maternal deaths and their causes, it has been demonstrated that anemia is responsible for 3.7% all of maternal deaths in Turkey [18]. In a survey conducted by the Ministry of Health, 54.7% of mothers receiving at least one diagnosis of anemia during their lives and 46.6% of the mothers (anemia diagnosed in 85.2% of mothers) had this diagnosis during pregnancy [19]. Birth and excess number of pregnancies, short pregnancy intervals, malnutrition, recurrent infections and blood losses due to miscarriages and unhealthy deliveries are the leading factors of anemia seen in pregnancy [20].

In the presented study, decreases were observed in hemoglobin and hematocrit levels of all of the women in the experimental and control groups in every trimesters. However, more pronounced decreases in hemoglobin levels were determined, particularly, in the second and third interviews after the second trimester (Table 2). In the last interviews, the percentages of the women with hemoglobin level lower than 11 g/dL were found as 64%, 60%, 72%, 64%, 68% and 60% respectively.

In another study conducted on 320 pregnant women determined the prevalence of anemia in pregnant women in Afyon province and the factors that affect anemia in order to attract the attention of public to this issue, and found the prevalence of anemia as 29.38 % in pregnant women by considering the hemoglobin values. The author reported that 17.65% of pregnant women with anemia were at first trimester, 32.48 % of them were at second trimester and remaining 32.59 % were at third trimester which indicates high prevalence, thus emphasized that the priority should be diverted to the education and service delivery [21]. In another survey conducted on the pregnant women admitted to Güzelbahçe Health Center, İzmir where located in western part of Turkey, the Hb level lower than 10.5 g/dL was accepted as anemic. The 28.9 % of the women was found anemic and the 75% anemia was due to iron deficiency. It has been shown that the risk of anemia increased by 2.8 fold in second trimester and 4.2 fold in third trimester. The 67 % of pregnant women used iron and folic acid pills with a doctor's recommendation during that survey, and no significant effect of the use of iron and folic acid on anemia in pregnant women was reported [22].

Dietary factors play a major role in the development of the anemia. Therefore, dietary nutrition education should be a good first step in preventing anemia depending on nutritional insufficiency. In our study no significant correlation was determined between nutrition knowledge and hemoglobin and hematocrit levels of the women. Lack of significant correlation between women's nutrition knowledge and hemoglobin and hematocrit levels in this study may be due to several variables affecting hemoglobin and hematocrit levels.

Education has always been a perennial process since the dawn of mankind. It can be said that in any situation where learning occurs educational process changes human behavior. Education is defined as the process forming desired changes in behaviors of individuals that occurs as a result of their experiences [23]. Nutrition education is not only an important factor in the development of healthy families and communities, but also, in some manner, it helps to improve the nutritional status of

women and children, and contribute to overcome the health problems such as chronic diseases, maternal mortality, infant and child deaths, which are still striking problems in our country. Nutrition education is one of the most important preventive health services.

It has been reported that the ultimate goal of nutrition education is to produce nutritionally literate decision makers who are motivated, knowledgeable, skilled, and willing to choose proper nutrition alternatives [24]. The lack of nutrition knowledge of families is one of the prime causes of malnutrition seen particularly in children and pregnant women. Although many families have enough food in various types in their homes, they cannot use them in accordance with the principles of nutrition. In the presented study, after every call, an increase was observed in nutrition knowledge status of women who received nutrition education. The increase in the awareness was the highest at all trimesters in the women who were monitored and trained nutrition starting from the first trimester. In this group, the scores were 15.4, 23.4 and 27.6 for the first, second and third trimesters respectively. Likewise, in this group, the number of wrong answers after each training was low, which was followed by the women who received education at second trimester and the highest wrong answers were given by the women who received education only at third trimester with the scores of 11.1, 10.1 and 7.6 for the first, second and third trimesters respectively ( $p < 0.05$ ) (Table 3).

Considering the questions for assessing the nutritional behavior of women, the highest number of correct answers for use of iodized salt, preparation and cooking the food and oil use was observed in women who received education. Compare to treatment Groups 2 and 3; higher rates of correct answers were determined in the treatment Group 1 for the questions such as what should be the first food for baby, when breast milk should be given for the first time after the birth. At the beginning of the study, the rates of correct answers given to the question searching the month of additional food was lower (32%, 32%, 44%, 48%, 20%, 52% respectively). But education increased the correct answer rates markedly in the experimental groups (80%, 36%, 60%, 56%, 60%, 40% respectively). Different responses were obtained from the participants concerning the time of first nutritional supplement to be taken. Rice flour-starch foods, milk and fruit juice had been preferred before the training whereas priority was given to milk and yogurt after the education.

Women in all experimental groups consumed the recommended nutrients, such as milk, yogurt, eggs, vegetables and fruit, more frequently than the women in the corresponding controls after the nutrition education with more pronounced increase in the experimental Group 1. Significant differences were determined between the interviews concerning the calcium, iron and vitamin A intake of the participants in the Group 1 and its control group (Control 1) ( $p < 0.05$ ) based on a daily dietary intake that was calculated from the energy and nutrient items coming from the consumption of food during a day. After the training, women in the experimental groups consumed these nutrients more than before the nutrition education. Energy, protein and vitamin C consumption levels were also increased in women in the experimental groups after training. An increase was observed in the consumption of food items of women in the Group 2 in the next meeting after the education ( $p < 0.05$ ). The increase only in vitamin A was significant ( $p < 0.05$ ) in the Control Group 2 (Table 4). Women receiving nutrition education at their third trimester consumed more energy and protein but decreases were observed in calcium, vitamin A and C intake ( $p < 0.05$ ). Declined energy, calcium and riboflavin intake in the corresponding controls at the last meeting (Control 3), may indicate that nutritional education in the last months of pregnancy is not very effective in the food intake.

#### 4. CONCLUSIONS

The results of the presented study have revealed that the knowledge of pregnant women in the rural area concerning the nutrition during pregnancy and anemia is insufficient which may lead the development of anemia and/or adversely affect the course of anemia. However, the desired level of nutrition education cannot be provided to most of the pregnant women who constitute an important risk group in our country. Therefore, providing nutrition education to the pregnant women is of paramount importance for the health of mother and unborn baby for creating healthier generation. In addition, determining nutrition policy and inserting it into routine health services for preventing nutritional problems in pregnancy as well as the implementation of comprehensive prenatal care and follow-up program and training of prenatal care staff by giving an effective nutrition education is a necessity in our country. The observation of very common and severe anemia in our country highlights the need of large-scale surveys. The importance of nutrition during pregnancy and breastfeeding emphasizes that the necessary precautions, such as iron and folate supplements in addition to dietary modification, should be taken for preventing the vitamin and mineral deficiencies.

#### ACKNOWLEDGMENT

The author acknowledge staff of Pregnancy Clinic of Maternal and Child Health and Family Planning Center in Çubuk, Ankara for their support given to this work.

#### REFERENCES

- [1]. D. Katz, S. C. R Friedman, L. C. Sean. *Nutrition in Clinical Practice*, 3<sup>rd</sup> ed. Pp: 377, USA, Wolters Kluwer, 2014.
- [2]. K. Abu-Saad, D. Fraser, "Maternal Nutrition And Birth Outcomes," *Epidemiologic Reviews*, vol.32 (1), pp.5-25, 2010.
- [3]. Ministry of Health. *Food and Nutrition Guidelines for Healthy Pregnant and Breastfeeding Women: A background paper*. Wellington, New Zealand, 2006.
- [4]. C. Athukorala, A.R.Rumbold, K.J. Willson "The risk of adverse pregnancy outcomes in women who are overweight or obese", *BMC Pregnancy Childbirth*, 10:56, 2010.
- [5]. WHO Regional Office for Europe, *Good maternal nutrition – the best start in life*, pp: 5, Copenhagen, Denmark, 2016.
- [6]. M.Soylu. *Gebeliklerinin farklı dönemlerinde verilen beslenme eğitiminin gebe kadınların genel sağlık ve beslenme*

- durumu üzerine etkisi*, Gazi Üniversitesi , Eğitim Bilimler Enstitüsü, Doktora Tezi, Ankara, Türkiye, 2004.
- [7]. Baysal, A. *Beslenme*, Hatipoğlu Yayıncılık, Ankara, Türkiye, 2014.
- [8]. T. Merdol, *Toplu Beslenme Yapılan Kurumlar İçin Standart Yemek Tarifeleri*, 4. Baskı, , Hatipoğlu Yayınevi, Ankara, Türkiye, 2011.
- [9]. V. Sümbüloğlu, K. Sümbüloğlu. *Biyoistatistik*. Özdemir Yayıncılık, Sayfa: 48-205. Ankara, Türkiye, 1993.
- [10]. M. L. Watkins, S. A. Rasmussen, M. A. Honeru. "Maternal obesity and risk for birth defects", *Pediatrics*,111:1152–1158, 2003.
- [11]. E. Ziegler, L. J. Filerje . *Present Knowledge in Nutrition*, 7<sup>th</sup> ed., ILSI Press, Washington, DC, 1996.
- [12]. I. Strychar, "Psychosocial and lifesyle factors associated with insufficient and excessive maternal weight gain during pregnancy", *Journal of The American Dietetic Association*, 100,3, 2000.
- [13]. WHO, Essential Antenatal, Perinatal and Postpartum Care, Training modules, WHO Regional Office for Europe, 2002.
- [14]. Sağlık Bakanlığı, *Güvenli annelik katılımcı kitabı*, Cinsel Sağlık / Üreme Sağlığı No: 2-B, T.C. Sağlık Bakanlığı Ana Çocuk Sağlığı ve Aile Planlaması Genel Müdürlüğü, Ankara, Türkiye, 2010.
- [15]. WHO Global Nutrition Targets 2025: Anaemia Policy Brief, WHO/NMH/NHD/14.4 [http://www.who.int/nutrition/topics/globaltargets\\_anaemia\\_policybrief.pdf?ua=1&ua=1](http://www.who.int/nutrition/topics/globaltargets_anaemia_policybrief.pdf?ua=1&ua=1)
- [16]. WHO, The Global Prevalence o Anaemia In 2011, World Health Organization, Geneva, Switzerland, 2015 [http://apps.who.int/iris/bitstream/10665/177094/1/9789241564960\\_eng.pdf?ua=1&ua=1](http://apps.who.int/iris/bitstream/10665/177094/1/9789241564960_eng.pdf?ua=1&ua=1)
- [17]. M.M. Rahman , S.K. Abe , M.S. Rahman and M. M., "Maternal anemia and risk of adverse birth and health outcomes in low- and middle-income countries: systematic review and meta-analysis" *Am J Clin Nutr.*,103(2), pp. 495-504, Feb . 2016.
- [18]. Hacettepe Üniversitesi Nüfus Etütleri Enstitüsü, *Türkiye Ulusal Anne Ölümleri Çalışması* 2005, Türkiye. [http://www.hips.hacettepe.edu.tr/uaop\\_ankara/ozet\\_rapor.pdf](http://www.hips.hacettepe.edu.tr/uaop_ankara/ozet_rapor.pdf)
- [19]. T.C. Sağlık Bakanlığı, *12-23 Aylık Çocuklarda Demir Kullanım Araştırması Raporu* , Sağlık Bakanlığı Ana Çocuk Sağlığı Aile Planlaması Genel Müdürlüğü, Ankara, Türkiye, 2009.
- [20]. M.A. Biliker. *Türkiye' de Ana Sağlığı Ve Aile Planlamasının Durumu*. 1.Ulusal Ana Çocuk Sağlığı Kongre Kitabı:Ankara , Türkiye, 2001.
- [21]. G. Beştepe , N. Bilgin. "Afyon ili 2 ve 4 no'lu sağlık ocaklarındaki gebelerde anemi prevalansı ve anemiyi etkileyen bazı etmenlerin incelenmesi", *Sağlık ve Toplum*, 2:43-53, 2002.
- [22]. Kılıç, B. "İzmir Güzelbahçe Sağlık Ocağı Bölgesindeki Gebe Kadınlarda Anemi Prevalansı". 1.Ulusal Ana Çocuk Sağlığı Kongresi, 286-287, Ankara, Türkiye, 2001.
- [23]. M. Sencer. "Türkiye' de Eğitim Sisteminin Yapısal Nitelikleri ve Temel Eğitim Sorunları" *TODAİ Dergisi*. (1) 8-9, 1979.
- [24]. T. H. Stuart, C. Achterberg. "Education and communication strategies for different groups and settings". FAO Corporate Document Repository, Retrieved March 09, 2016. <http://www.fao.org/docrep/w3733e/w3733e04.htm>

## BIOGRAPHY

Meltem Soylu was born in Ankara, Turkey. She received his bachelor's degree and got master degree in the Hacettepe University, Ankara and got her PhD in nutritional education at Gazi University, Ankara, Turkey. Now, she works as assistant professor doctor in the Faculty of Health Sciences of the Nuh Naci Yazgan University in Kayseri. Her primary research interests include public health nutrition and education.

Table 1: Background Characteristics of Pregnancies

	1.GROUP			
	Experimental		Control	
	x	±Sx	x	±Sx
Age years	21.32	0.63	21.84	0.68
Marriage age	18.96	0.48	18.8	0.54
First gestational age	19.32	0.45	19.28	0.54
Pre-Pregnancy Weight (kg)	55.72	1.41	58.66	1.55
Weight (cm)	158.1	1.01	159.73	0.75
Pre-Pregnancy BKI	22.38	0.4	22.94	0.51
Birth Interval (month)	44.0	9.17	44.57	11.73
Weight gain (kg/week)*	0.383	0.05	0.265	0.03

p<0.05

	2.GROUP				3.GROUP			
	Experimental		Control		Experimental		Control	
	x	±Sx	x	±Sx	x	±Sx	x	±Sx
	23.44	0.86	23.24	0.6	21.76	0.71	22.12	0.75
	19.64	0.51	19.04	0.34	19.52	0.49	18.92	0.55
	20.08	0.52	19.04	0.36	20.32	0.53	20.08	0.59
	53.2	1.62	54.96	2.05	56.36	1.56	56.16	1.53
	159.2	0.78	160.88	1.04	157.56	0.93	159.52	0.84
	20.95	0.56	21.17	0.71	22.82	0.63	22.01	0.53
	52.4	9.38	30.61	5.25	36.4	8.54	33.76	8.31
	0.513	0.05	0.275	0.02	0.411	0.03	0.487	0.05

Table 2: Hemoglobin and Blood Pressure of Pregnancies of Experimental and Control Groups

	1.GROUP											
	Experimental				Control				3 Interview			
	1 Interview		2 Interview		3Interview		1Interview		2Interview		3 Interview	
	x ±	Sx	x ±	Sx	x ±	Sx	x ±	Sx	x ±	Sx	x ±	Sx
Hgb (g/dL)	11.3	0.1	10.7	0.2	10.3	0.2	11.5	0.2	10.9	0.2	10.4	0.2
Hct (%)	37.3	0.5	35.2	0.4	33.7	0.5	36.8	0.6	34.9	0.5	33.4	0.6
Pulse (min)	84.1	0.1	84.9	0.3	84.9	0.3	84.5	0.9	84.8	0.8	84.9	0.3
Diastolic (mmhg)	61.2	1.6	60.2	1.4	59.8	1.5	65.0	2.6	61.7	1.6	63.5	2.1
Sistolik (mm hg)	106.6	2.2	10	2.4	103.4	2.3	109.0	3.1	111.6	1.6	105	2.1

p>0.05

	2.GROUP								3.GROUP							
	Experimental				Control				Experimental				Control			
	1 Interview		2 Interview		1Interview		2Interview		1Interview		2Interview		1Interview		2Interview	
x ±	Sx	x ±	Sx	x ±	Sx	x ±	Sx	x ±	Sx	x ±	Sx	x ±	Sx	x ±	Sx	
	10.6	0.2	10.4	0.2	10.9	0.2	10.6	0.2	10.6	0.2	10.6	0.2	10.9	0.3	10.6	0.3
	34.1	0.7	32.5	0.6	34.8	0.6	33.7	0.6	33.4	0.6	33.3	0.4	33.9	0.7	32.7	0.8
	84.5	0.9	84.9	0.3	84.6	0.4	85.0	0.4	84.1	0.2	84.6	0.2	84.5	0.3	84.5	0.3
	58.2	1.6	60.8	1.3	63.4	2.1	63.0	2	64.8	2.1	63.2	1.4	68.0	2.2	68.0	2.9
	102.2	3	103.6	2.6	104.8	3.3	104.4	2.8	102.8	2.3	104.	2.4	114.	1.8	110.	2.1

\*p<0.05

Table 3: Nutrition Knowledge Score of Experimental and Control Groups

	1.GROUP*											
	Experimental						Control					
	1 Interview		2 Interview		3Interview		1Interview		2Interview		3 Interview	
	n	%	n	%	n	%	n	%	n	%	n	%
Correct	15.4	1.2	23.4	1.2	27.6	0.8	14.1	1.2	13.6	1.1	13.9	1.2
Wrong	11.1	0.9	10.1	0.9	7.6	0.7	12	0.9	12	0.9	11.5	0.9
No idea	7.4	0.8	2.1	0.5	1.1	0.2	6.8	1	7.4	1	8	1.1

	2.GROUP*								3.GROUP*							
	Experimental				Control				Experimental				Control			
	1 Interview		2		1Intervie		2Intervie		1Intervi		2Intervie		1Intervie		2Intervie	
	n	%	n	%	n	%	n	%	n	%	n	%	n	%	n	%
	17	0.9	25.4	1.1	14.1	0.9	14.3	0.9	12.5	0.9	24	1.1	14.4	1	15.4	0.9
	11.6	0.7	9.6	0.9	11.6	0.7	11.8	0.7	10.9	0.4	9.7	0.9	13.8	0.6	13.4	0.7
	6.2	0.7	1.9	0.3	7.1	0.8	6.8	0.8	10.9	0.9	3.1	0.6	6.7	0.8	6.1	0.6

Table.4 : Energy and Nutrients Consumption of Experimental and Control Groups

\*p<0.05

	1.GROUP												
	Experimental				3Interview				Control				
	1 Interview		2 Interview		x ±		Sx		1Interview		2Interview		3 Interview
	x ±	Sx	x ±	Sx	x ±	Sx	x ±	Sx	x ±	Sx	x ±	Sx	
<b>Energy*</b>	2355	117	2708	125	2740	87	2437	102	2673	120	2687	100	
<b>Protein(g)</b>	72.2	3.9	81.6	3.9	88.1	3.7	75.7	3.6	82.1	3.4	86.6	4.8	
<b>Fat(g)</b>	81.8	5.9	100.5	5.6	90.3	4.6	79.9	5.5	97.3	5.8	85	6.2	
<b>Ca(mg)*</b>	628	70	881	82	1084	77	581	64	733	8	1024	97	
<b>Fe(mg)*</b>	17.5	1.5	18.8	1	21.2	1.4	16.2	1.2	19.8	1.9	48.1	19.8	
<b>Vit. A(IU)*</b>	7115	1276	7408	1094	11980	1831	7398	1715	7026	1078	10663	2142	
<b>Thiamine mg</b>	2.2	0.2	2.4	0.2	2.9	0.2	2.49	0.2	2.7	0.2	3.2	0.2	
<b>Riboflavin mg*</b>	1.3	0.1	1.7	0.1	2.4	0.2	1.21	0.1	15.1	13.5	2.7	0.41	
<b>Niacin(mg)</b>	15.3	1.1	16.2	1.1	17.8	0.9	14.5	0.6	17	1	19.4	1.6	
<b>Vit. C(mg)*</b>	133.6	13	200	24.7	204.0	21.9	147.7	23.8	160.6	24.6	223.7	28.7	

	2.GROUP								3.GROUP							
	Experimental				Control				Experimental				Control			
	1 Interview		2 Interview		1Interview		2Interview		1Interview		2Interview		1Interview		2Interview	
x ±	Sx	x ±	Sx	x ±	Sx	x ±	Sx	x ±	Sx	x ±	Sx	x ±	Sx	x ±	Sx	
2523	102	2883	116	2510	121	2639	120	2435	99	2672	87	2689	120	2622	143	
76.3	3.2	91.6	4.6	81.8	5.3	84.9	5.3	69.5	3.4	82.5	2.5	80.7	4.9	73.7	3.86	
102.6	4.1	106	6.3	89.9	5.9	92	5.2	90.7	7.7	93.2	5.9	118.1	8.0	125.97	11.2	
704	48	932	49	755	70	842	98	984	302	785	51	907	111	722	86.8	
17.3	1	44.8	16.3	18.7	2.4	21.2	2.9	46.8	27.8	19.4	1.9	16.1	1.6	14.8	3.40	
6664	889	10000	1972	6874	1276	9194	1696	7880	1643	5793	1163	13654	3359	562	1871	
2.6	0.2	3.9	0.9	2.5	0.2	2.5	0.2	2.2	0.4	2.3	0.2	1.9	0.3	2.4	0.27	
1.5	0.2	2.3	0.3	1.6	0.2	2.3	0.4	1.5	0.1	1.6	0.1	3.3	0.4	2.8	0.3	
15.9	0.9	18.4	1.7	16.4	1.7	16.8	1.7	14.4	1.2	16.1	0.9	14.4	1.3	14.3	1.08	
156.3	16.5	185.9	17.2	146.7	20.6	148.3	18.5	221.5	80.1	132.7	15.7	155.6	21.1	270.6	23.1	



# Mineral Contents Of Weed Crops In Central Anatolian Region

Mahmut Kaplan<sup>1</sup>, Kagan Kokten<sup>2</sup> Tugay Ayasan<sup>3</sup>, Alperen Meral<sup>4</sup>

---

## Abstract

Objective of the research is to determine the mineral contents of weed crops intensively grazed by livestock of Central Anatolian Region. A total of 11 weed crops (*Sinapis arvensis*, *Lamium album*, *Malva* spp., *Convolvulus arvensis*, *Chenopodium album*, *Alhagi* spp., *Sanguisorba minor* Scop., *Amaranthus* spp., *Taraxacum officinale*, *Polygonum cognatum* and *Sorghum halepense*) collected from pastures and field of Kayseri were used as the material of the research. Plant samples were collected at blooming periods during June of the year 2011. Samples were dried and mineral contents were determined with 3 replications. Statistical analyses were performed based on randomized block design.

Phosphorus, Calcium, Potassium, Nickel, Cadmium, Lead, Copper, Manganese, Sodium, Zinc, Iron, Magnesium and Boron were determined in the weed plants in dissimilar numbers. The close analysis indicated that the weed seeds contained Cu 8.115-9.360, Mn 65.905-77.890, Zn 30.405-42.105, Fe 254.0-290.5, Mg 2118.0-2414.0, B 6.385-9.655, Ni 0.2305-0.2945, P 2640.5-3307.5, Ca 8193.0-8965.0, K 10221.51-12332.0, Cd 0.1625-0.2235, Pb 0.3345-0.4160 and Na 1181.51-1475.5 mg kg<sup>-1</sup>, respectively. Results indicated that weed plants of Central Anatolia were rich in trace elements and there was no need for supplemental trace elements.

**Keywords:** weed, mineral content, correlation, biplot.

---

## 1. INTRODUCTION

Pecora browsing indicates a system of land admin in non-farm marginal fields, but, on grassland pecora browsing indicates the most appropriate terrain use (Jones and Martin 1994).

Weeds are important feed source for ruminants grazing over the rangelands of Turkey. However, there are limited studies about nutritional values of these weeds. Alternative feed sources are widely used as regional feed sources without reducing the livestock performance. They can reduce feeding costs through providing a full or partial alternative to forage graminæ or concentrate feed (Sallam, 2005). It is usually thought that weeds had low nutritional values and were not grazed by livestock; therefore, expensive and time-consuming methods were used in weed control (Marten and Andersen, 1975). Some of these weeds are poisonous and toxic to farm animals and some others result in decreasing feed consumption. Several weed species have thorns and hard leaves, so may injure animal mouths and they even cause eye diseases ending up with blindness. Some weeds may cause to have undesired odor or taste in meat and milk. Weeds mostly contest with culture products and forage crops for water, sunlight and nutrients. On the other hand, some weeds have quite high nutritional values and digestibility (Lewis and Green, 1995). This research was carried out to detect nutritional values of common weeds in range lands of Turkey (Bosworth et al., 1985).

Both warm- and cool-season weeds contained enough calcium for moderate producing cattle. Warm-season broadleaf weeds were high in calcium. In contrast, sicklepod, tall morningglory, cutleaf evening primrose, wild rye, and little barley were down in P and suboptimum for superior-producing cattle. Magnesium content of warm-season weeds was adequate. Most cool-season weeds tested were low enough in magnesium to be considered possible inducers of grass tetany if used as the sole source of feed. Henbit at 0.4% and primrose at 0.3% were unusually high in magnesium. Potassium levels of both weeds and cultivated forages were well above nutrient requirements (Hoveland, 1995).

There are some literatures about our studied plants for some quality properties. Akubugwo et al. (2008) have stated that elements in *S. nigrum* but only for Sodium, Calcium, Iron and Magnesium in *Amaranthus hybridus* L. Sodium/Potassium and Calcium/Phosphorus rates varied between 0.13 and 0.14, and 1.24 and 1.28 in *Amaranthus h. L.*, while amounts for *Solanum nigrum* L. were 0.70 and 0.80, and 0.21 and 0.24, respectively, in all the treatments. Sultan et al (2008) detected macro (Calcium, Phosphorus, Potassium and Magnesium) and micro (Copper, Zinc, Manganese and Cobalt) nutrients in plant samples taken from 10 different freely-grazed rangelands. Early-blooming period Ca, P, K and Mg contents were respectively observed as 0.26±0.022, 0.025±0.004, 0.69±0.113 and 0.044±0.006. Early-blooming Cu, Zn, Mn and Co contents were respectively observed as 22.75±2.671, 14.70±2.065, 10.12±1.770 and 0.023±0.003. Ripening period Ca, P, K and Mg contents were respectively identified as 0.30±0.049, 0.031±0.006, 0.68±0.108 and 0.028±0.004. Ripening period Cu, Zn, Mn and Co contents

---

<sup>1</sup> Corresponding author: Erciyes University, Department of Field Crops, Kayseri, [mahmutk@erciyes.edu.tr](mailto:mahmutk@erciyes.edu.tr)

<sup>2</sup> Bingol University, Department of Field Crops, Bingol, [kahafe1974@yahoo.com](mailto:kahafe1974@yahoo.com)

<sup>3</sup> Eastern Mediterranean Agricultural Research Institute, Adana, [tayasan@gmail.com](mailto:tayasan@gmail.com)

<sup>4</sup> Bingol University, Department of Architecture, Bingol, [ameral@bingol.edu.tr](mailto:ameral@bingol.edu.tr)

were respectively observed to be  $29.8 \pm 2.962$ ,  $8.96 \pm 2.0701$ ,  $6.14 \pm 1.034$  and  $0.029 \pm 0.005$ . Krishnaiah et al. (2008) have pointed that the element content of some weed plants *Eucheuma*, *Sargassum*, *Caulerpa*, *Gracilaria*, *Gelidiella*, *Kappaphycus* and *Ulva* was examined. The Fe content was rich in the line of *Gelidiella* > *Caulerpa* > *Sargassum* > *Eucheuma* and its interval was identified to be 6.6-10.9 mg/100g dry weight. The large etesian variation was determinate to be 9.3% Magnesium, 6.4% Calcium and 5.3% Iron.

There a few studies performed to determine the mineral contents of weed crops. Therefore, aim of the research was set as to detect mineral contents of weed crops with a significant role in ruminant livestock feeding.

## 2.MATERIAL AND METOD

A total of 11 weeds were used as the plant material of this research. Plant samples were collected from pastures and field of Kayseri Province and analyzed in laboratories of Biology department of Erciyes University Natural Sciences Faculty. Surface area of Kayseri is 16.917 km<sup>2</sup> with an altitude of 1050 meters. Cold terrestrial climate is dominant in Kayseri. Summer is hot and dry and winter is cold and snowy. The province has an annual precipitation of 366 mm with the highest precipitation in March, April and May and the lowest in June, July and August. Extreme temperatures were recorded as between  $-32.5$  °C and  $+40.7$  °C.

Plant samples were taken in June during the flowering periods of the plants. Samples were dried at 70 °C for 48 hours, granulated in crusher with 1mm screen and arranged for chemical analysis.

The weed samples were run across wet-ashing continuum with hydrogen peroxide (2:3) in 3 dissimilar paces (First paces: at 145 °C 75% microwave force for five minutes, second paces: at 80 °C 90% microwave power for ten minutes and third paces: at 100 °C 40% microwave force for ten minutes) in a wet-ashing monad (speed wave MWS/2 Berg. prod. + Instru. Harres.1. 72800 E. Germany) durable to 40 bar compression (Mertens, 2005a). Then macro and micro nutrient (Phosphorus, Potassium, Calcium, Magnesium, Sodium, Iron, Manganese, Zinc, Nickel, Cadmium, Copper, Lead and Boron) content of weed plants were detected by using ICP/OES spectrophotometer (Perkin-Elmer, Opt. 2100/DV, ICP-OES, Shel., CT/06484/4794, USA) (Mertens, 2005b).

SAS (SAS Inst., 1999) was used to perform variance analysis on experimental data and Duncan testing was usage to test the importance of variations among means.

## 3.RESULTS AND DICCUSSION

### 3.1.Mineral Contests of Weed Crops

Highly significant differences were observed in mineral contents of weed plants (Table 1). While the lowest P (2640.5 mg kg<sup>-1</sup>), Ni (0.2305 mg kg<sup>-1</sup>) and B (6.385 mg kg<sup>-1</sup>) contents were obtained from *Sanguisorba minor* Scop., the highest P content (3307.5 mg kg<sup>-1</sup>) was seen in *Sorghum halepense*, the highest Ni value (0.2945 mg kg<sup>-1</sup>) in *Alhagi* spp. and the highest B value (9.655 mg kg<sup>-1</sup>) in both *Sinapis arvensis* and *Chenopodium album*. The lowest Ca content was obtained from *Convolvulus arvensis*, the highest Ca content (8965.0 mg kg<sup>-1</sup>) was observed in *Alhagi* spp. Elements of Ca and P are significant in bone, teeth and muscle metabolism (Dosunmu, 1997; Turan et al., 2003). Ca acts as a co-factor for additional celled proteins and enzyme (Krishnaiah et al., 2008).

While the lowest Mg (2118.0 mg kg<sup>-1</sup>), Cu (7.115 mg kg<sup>-1</sup>) and Cd (0.1625 mg kg<sup>-1</sup>) contents were obtained from *Chenopodium album*, the highest Mg value (2414.0 mg kg<sup>-1</sup>) was seen in *Convolvulus arvensis*, the highest Cu value (9.360 mg kg<sup>-1</sup>) in *Malva* spp. and the highest Cd (0.2235 mg kg<sup>-1</sup>) in *Sorghum halepense*. Magnesium plays a significant role in cardiovascular function. Copper-like micro elements exist in structural, regulatory and catalisator functions, nucleic acids and hormones stabilizing membranes. These elements also increase pigmentation in eye, hair and skin, blood-clotting and energy transformation and they have a potential economic significance (Levine 1984; Phillips 1995; Moy and Walday 1996; Krishnaiah et al. 2008). Minson (1990) noticed that growing Mo intromission intercepted Copper toxicity in farm animals. Same researchers also indicated increased Cu concentrations with increasing soil temperatures from 12 to 20 °C.

With regard to Na contents, the lowest (1181.5 mg kg<sup>-1</sup>) and the highest (1475.5 mg kg<sup>-1</sup>) values were observed respectively in *Alhagi* spp. and *Polygonum cognatum*. Sodium acts as electrolyte balance. Na content of weed plants was considerably lower than that obtained by Krishnaiah et al. (2008). This might be due to differences in plants species. The lowest Mn content (65.905 mg kg<sup>-1</sup>) was found in *Malva* spp. and the highest (77.890 mg kg<sup>-1</sup>) in *Sorghum halepense*. The Manganese ingredient in independent grassland grasses was enough to meet the pecora necessities (Perveen 1998).

While the lowest K, Zn and Pb contents were observed in *Amaranthus* spp. (10221.5, 30.405 and 0.3345 mg kg<sup>-1</sup>, respectively), the highest K content (12332.0 mg kg<sup>-1</sup>) was seen in *Lamium album*, the highest Zn value (42.105 mg kg<sup>-1</sup>) in *Alhagi* spp. and the highest Pb value (0.4160 mg kg<sup>-1</sup>) in *Malva* spp. Humphreys (1984) reported K concentration of tropical gramineae plants ranged from 0.6 to 1.2%. Potassium was reported to activate several enzyme system effecting plant growth (Humphreys 1984) (Hussain and Durrani 2007; Khan et al. 2007; Sultan et al. 2007; Sultan et al. 2008a; 2008b; Inam-Ur-Rahim et al. 2008). The lowest Fe content (254.0 mg kg<sup>-1</sup>) was obtained from *Convolvulus arvensis* and the highest value (290.5 mg kg<sup>-1</sup>) was observed in *Sorghum halepense*. While zinc exist in regular function of immune system, Fe present in structure of hemoglobin, energy metabolism and regular function of nervous system. (Shills and Young 1988; Adeyeye and Otokiti 1999; Ishida et al. 2000). Mineral contents may vary based on crop type and species, time of harvest, soil and climate conditions and stress factors (Gralak et al., 2006).

### 3.2. Correlations among Mineral Content of Weed Plants

As indicated in Table 2, positive and significant correlation between Na-K, Zn-Mg, Ni-Zn, Cd-Mg, Cd-Fe, Pb-Zn and Pb-Cd contents and a negative and significant correlation between Cu-Mn contents of weed plants ( $p < 0.05$ ) were observed.

### 3.3. Analysis of Biplot

Analysis of biplot was used to contrast the mineral contents of the weeds and to define weed plants and groups (Yan and Kang 2003). Biplot was able to represent 50% of total variation in mineral contents of 11 different weed species. Two perspectives were taken into consideration in biplot application as of (i) the positive relationship among Mn, Fe, Cd, P and Zn; positive relationship among Pb, Mg, Ca, Na, Ni and K; positive relationship between B and Cu, (ii) the negative relationship between Cu and Mn.

Second, it represents the feature side views of the weed plants, especially those that are established over far from the biplot source. For instance, it represents that *Sinapis arvensis*, *Lamium album*, *Taraxacum officinale* and *Malva* spp. had extremely high Cu but low Mn; *Polygonum cognatum* had extremely high P but low Cu; and *Sorghum halepense* had extremely high P, Mn, Fe and Cd but lower levels for Mg, Ca, K, Na, Ni and Cu. *Amaranthus* spp. *Chenopodium album* and *Sanguisorba minor* Scop the poor crops in mineral content, except phosphorus and boron (Table 1 and Figure 1).

## 4. CONCLUSION

It was observed in this study that some weeds had quite high nutritional values and even higher than some culture crops. In general, the greatest Mn, Fe, Cd and P contents were observed in *Sorghum halepense* plants, the greatest Pb and Cu contents in *Malva* spp. plants, Ca, Ni and Zn contents in *Alhagi* spp. plants, Mg content in *Convolvulus arvensis* plants, K content in *Lamium album* plants, Na content in *Polygonum cognatum* plants and B content in *Sinapis arvensis* and *Chenopodium album* plants. It was concluded herein that weeds may constitute a low-cost feed source and may provide several macro and micro nutrients.

## REFERENCES

- [1] Adeyeye, E.I. and M.K.O. Otokiti, 1999. Proximate composition and some nutritionally valuable minerals of two varieties of *Capsicum annum* (Bell and Cherry peppers). *Discovery Innovation*, 11:75-81.
- [2] Akubugwo, I.E., Obasi, N.A., Chinyere, G.C. and Ugbogu, A.E., 2008. Mineral and phytochemical contents in leaves of *Amaranthus hybridus* L and *Solanum nigrum* L. subjected to different processing methods. *African Journal of Biochemistry Research*, 2(2):040-044.
- [3] Bosworth, S.C., C.S. Hoveland, and G.A. Buchanan, (1985). Forage quality of selected cool-season weed species. *Weed Science* 34:150-154.
- [4] Dosunmu, M.I., 1997. Chemical composition of the fruit of *Tetrapleura tetrepra* and the physico-chemical Properties of its oil. *Global J. Pure and Applied Sci.* 3:61-67.
- [5] Gralak, M.A., Bates, D.L., Von Keyserlingk, M.A.G., Fisher, L.J. (2006) Influence of species, cultivar and cut on the micro element content of grass forage. *Slovak Journal Animal Science* (1-2):84-88.
- [6] Hoveland, C.S. (1995). *Weeds for Pasture and Hay? The Georgia Cattleman*. 20-23.
- [7] Humphreys, L.R. 1984. *Tropical pastures and fodder crops*. Longman Group U.K. Ltd. Longman House, Burnt Mill, Harlow Essex CM 20 2J. E. England.
- [8] Hussain F. and M. J. Durrani. 2007. Forage productivity of arid temperate Harboi rangeland, Kalat, Pakistan. *Pak. J. Bot.*, 39(5): 1455-1470.
- [9] Inam-Ur-Rahim, J. I. Sultan, M. Yaqoob, H. Nawaz, I. Javed and M. Hameed. 2008. Mineral profile, palatability and digestibility of marginal land grasses of Trans-Himalayan grasslands of Pakistan. *Pak. J. Bot.*, 40(1): 237-248.
- [10] Ishida H, Suzuno H, Sugiyama N, Innami S, Todoru T, Maekawa A (2000). Nutritional evaluation of chemical components of leaves, stalks and stem of sweet potatoes (*Ipomea batatas* Poir). *Food Chem.* 68:359-367.
- [11] Jones, G.E and Martin, S. 1994. *Eco zone suite of model*, for FAO training service. Eco zone Gough SAC Edinburgh Policy Analysis Division, Rome.
- [12] Khan, Z.I., M. Ashraf, K. Ahmad, I. Mustafa and M. Danish., 2007. Evaluation of micro minerals composition of different grasses in relation to livestock requirements. *Pak. J. Bot.*, 39(3): 719-728.
- [13] Krishnaiah, D., Sarbatly, R., Parasad, D.M.R. and Bono, A., 2008. Mineral content of some seaweeds from Sabah's South China Sea. *Asian Journal of Scientific Research*, 1(2): 166-170.
- [14] Levine, H.G., 1984. The use of seaweed for monitoring coastal waters. In: *Algae as ecological indicators*. Schubert, L.F. /Ed.), Academic press, London, pp: 189-210.
- [15] Lewis, W.M., and J.T. Green Jr. 1995. *Weed management*. In: *Production and utilization of pastures and forages*. Raleigh (NC): North Carolina State University, North Carolina Agricultural Research Service; Technical bulletin 305.
- [16] Marten, G.C., and R.N. Andersen, (1975). Forage nutritive value and palatability of 12 common annual weeds. *Crop Science* 15: 821-827.13.
- [17] Mertens, D (2005a) AOAC official method 922.02. In: Horwitz, W., Latimer, G.W. (Eds.), *Plants Preparation of Laboratory Sample. Official Methods of Analysis*, 18th ed. AOAC-International Suite, Gaithersburg, MD, USA, (Chapter 3), pp. 1-2.
- [18] Mertens, D (2005b) AOAC official method 975.03. In: Horwitz, W., Latimer, G.W.(Eds.), *Metal in Plants and Pet Foods. Official Methods of Analysis*, 18th ed. AOAC-International Suite, Gaithersburg, MD, USA, (Chapter 3), pp. 3-4.
- [19] Minson, D.J., 1990. The chemical composition and nutritive value of tropical grasses. In: *Tropical grasses FAO Plant Production and Protection Series*, No: 23. (Eds.): P.J. Skerman and F. Riveros. FAO Rome.
- [20] Moy, F.E. and Walday, M., 1996. Accumulation and depuration of organic micro-pollutants in marine hard bottom organisms. *Mar. Pollut. Bull.*, 33:56-63.
- [21] Perveen, S., 1998. Nutritive evaluation of some fodder tree leaves through In vitro digestibility techniques. Technical Paper, NWFP Agricultural University, Peshawar.

- [22] Phillips, D.J.H., 1995. The chemistries and environmental fates of trace metals and organochlorines in aquatic ecosystems. *Marine Pollut. Bull.*, 31:193-200.
- Sallam, S.M.A., 2005. Nutritive value assessment of the alternative feed resources by gas production and rumen fermentation in vitro. *Res. J. Agric. Biol. Sci.*, 1(2):200-209.
- SAS (1999) SAS User's Guide: Statistic. Statistical Analysis Systems Institute Inc., Cary, NC.
- Shills, M.E.G., Young, V.R., 1988. Modern nutrition in health and diseases. In: Nutrition. Nieman, D.C., Buthepodorth, D.E. and Nieman, C.N. (eds). WMc. Brown publishers, Dubugue, USA. pp. 276-282.
- Sultan, J. I., Inam-Ur-Rahim, Haq Nawaz and Muhammad Yaqoob. 2007. Nutritive value of marginal land grasses of northern grasslands of Pakistan. *Pak. J. Bot.*, 39(4): 1071-1082.
- Sultan, J. I., Inam-Ur-Rahim, M. Yaqoob, H. Nawaz and M. Hameed. 2008a. Nutritive value of free rangeland grasses of northern grasslands of Pakistan. *Pak. J. Bot.*, 40(1): 249-258.
- Sultan, J.I., Inam-Ur-Rahim, Nawaz, H., Yaqoob, M. and Javed, I., 2008b. Mineral Composition, Palability and Digestibility of Free Rangeland Grasses of Northern Grasslands of Pakistan. *Pak. J. Bot.*, 40(5):2059-2070.
- Turan, M., Kordali, S., Zengin, H., Dursun, A. and Sezen, Y., 2003. Macro and Micro- Mineral content of some wild edible leaves consumed in Eastern Anatolia. *Acta Agriculture Scandinavia, Section B, Plant Soil Science* 53:129-137.
- Yan, W. and M.S. Kang, 2003. GGE-biplot Analysis: A Graphical Tool for Breeders, Geneticists, and Agronomists, CRD Press., Boca Raton.

Table 1. Mineral contents of weed plants

Weed Plants	P	Mg	Ca	K	Na	Mn
	mg kg <sup>-1</sup>					
<i>Sinapis arvensis</i>	2876.5ab	2270.5f	8701.0b	10580.5i	1261.5h	69.760h
<i>Lamium album</i>	2956.0ab	2243.5h	8612.5c	<b>12332.0a</b>	1430.5b	68.540i
<i>Malva spp.</i>	2986.5ab	2394.0b	8321.5h	12125.5b	1405.0d	<b>65.905i</b>
<i>Convolvulus arvensis</i>	3111.5ab	<b>2414.0a</b>	<b>8193.0j</b>	11187.5e	1420.0c	70.685g
<i>Chenopodium album</i>	2988.0ab	<b>2118.0k</b>	8230.5i	10363.5k	1267.5g	72.805d
<i>Alhagi spp.</i>	3212.0a	2332.5e	<b>8965.0a</b>	10783.0h	<b>1181.5i</b>	72.255f
<i>Sanguisorba minor Scop.</i>	<b>2640.5b</b>	2342.0d	8551.5e	11353.0d	1215.5k	73.035c
<i>Amaranthus spp.</i>	2914.0ab	2192.5i	8404.0g	<b>10221.5i</b>	1218.0j	72.405e
<i>Taraxacum officinale</i>	3111.5ab	2132.5j	8596.0d	10954.5g	1307.5f	68.105j
<i>Polygonum cognatum</i>	3236.5a	2384.5c	8232.5i	11634.5c	<b>1475.5a</b>	75.235b
<i>Sorghum halepense</i>	<b>3307.5a</b>	2266.5g	8412.0f	11084.5f	1355.5e	<b>77.890a</b>
Significance Level	N.S.	***	***	N.S.	***	***

\*P<0.05; \*\* P<0.01; \*\*\* P<0.001; N.S: Not Significant

Table 2. Mineral contents of weed plants

Zn	Fe	Cu	Ni	Cd	Pb	B
mg kg <sup>-1</sup>						
31.465h	270.5d	8.915b	0.2405e	0.1815g	0.3455h	<b>9.655a</b>
32.910g	274.5c	9.345a	0.2540c	0.1885e	0.3635f	9.535a
36.440de	270.5d	<b>9.360a</b>	0.2605b	0.1935d	<b>0.4160a</b>	9.360a
38.965c	<b>254.0h</b>	7.550g	0.2455d	0.1855f	0.3460g	9.035ab
34.320f	271.0d	<b>7.115j</b>	0.2355f	<b>0.1625i</b>	0.3685e	<b>9.655a</b>
<b>42.105a</b>	281.0b	8.270e	<b>0.2945a</b>	0.2040c	0.4150a	9.140ab
35.105ef	265.0e	7.450h	<b>0.2305g</b>	0.2145b	0.3915b	<b>6.385b</b>
<b>30.405h</b>	262.5fg	8.625d	0.2335f	0.1765h	<b>0.3345i</b>	9.325ab
37.645cd	254.5h	8.905b	0.2550c	0.1760h	0.3730d	8.715ab
40.515b	264.5ef	7.230i	0.2550c	0.1945d	0.3855c	9.380a
36.685d	<b>290.5a</b>	7.620f	0.2450d	<b>0.2235a</b>	0.3930b	9.570a
***	***	***	***	N.S.	N.S.	***

Table 3 Correlations among minerals contents of weed plants

	P	Mg	Ca	K	Na	Mn	Zn	Fe	Cu	Ni	Cd	Pb	B
P	1												
Mg	0,027	1											
Ca	-0,126	0,165	1										
K	-0,014	0,567	0,044	1									
Na	0,361	0,444	-0,380	<b>0,735</b>	1								
Mn	0,287	0,227	0,075	-0,176	0,002	1							
Zn	0,572	<b>0,581</b>	0,220	0,295	0,295	0,318	1						
Fe	0,283	0,110	0,394	0,125	-0,065	0,466	0,110	1					
Cu	-0,175	-0,181	0,308	0,247	-0,012	<b>-0,757</b>	-0,387	-0,039	1				
Ni	0,549	0,193	0,422	0,197	-0,007	-0,209	<b>0,607</b>	0,271	0,281	1			
Cd	0,102	<b>0,648</b>	0,407	0,430	0,128	0,568	0,467	<b>0,579</b>	-0,232	0,145	1		
Pb	0,227	0,553	0,360	0,496	0,145	0,219	<b>0,723</b>	0,487	-0,130	0,516	<b>0,680</b>	1	
B	0,557	-0,072	-0,033	-0,035	0,370	0,038	0,004	0,327	0,210	0,213	-0,260	-0,109	1

In bold, significant values (except diagonal) at the level of significance alpha=0,050 (two-tailed test)

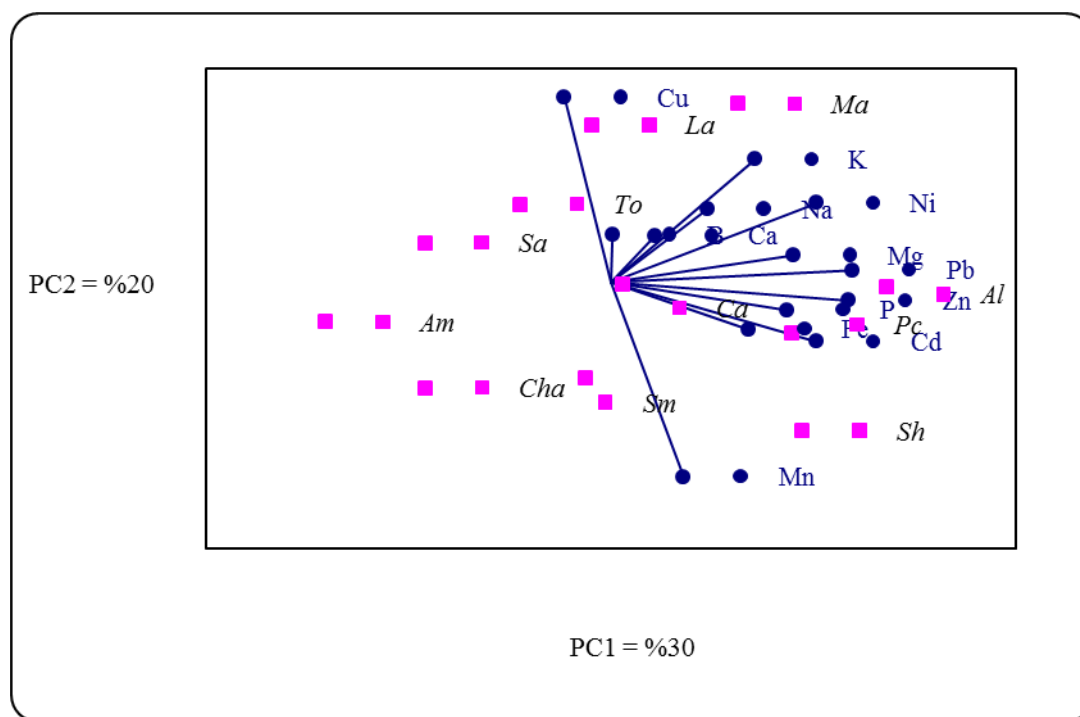

Figure 1. Biplot polygon for mineral contents of weed plants

**Sa:** *Sinapis arvensis*, **La:** *Lamium album*, **Ma:** *Malva* spp, **Ca:** *Convolvulus arvensis*, **Cha:** *Chenopodium album*, **Al:** *Alhagi* spp, **Sm:** *Sanguisorba minor* Scop, **Am:** *Amaranthus* spp, **To:** *Taraxacum officinale*, **Pc:** *Polygonum cognatum*, **Sh:** *Sorghum halepense*,

# A Research on Internal Marketing and Motivation: Employee Evaluation of Training and Development Programmes in Banking Sector

*Kenan Gullu<sup>1</sup>, Onur Celik<sup>2</sup>, Tugce Gullu<sup>3</sup>, Hamdi Bayram<sup>4</sup>*

---

## Abstract

*Participation in training and development programs is quite important to employees as being internal customers for the increase of employee motivation in services sector. In this context, this study examines the employee evaluation of training and development programs in banking sector with the blend of secondary and primary data which was collected through an e-mail survey applied to the employees working in the branch of a Turkish bank in Kayseri, Turkey. Statistical analyses of data indicate that employee motivation differs in terms of employee participation in any training and development programs and the working experience in the sector. The study concludes that employee participation in training and development programs is important in enhancing employee motivation in the services sector. The results are in line with the current literature.*

*Keywords: Internal marketing, training and development programs, employee motivation.*

---

## 1. INTRODUCTION

Employee training and development programs have a basic role in increasing employee motivation in the service organizations since there is a significant relation between internal service quality and external service quality [1]. Sustainable training and development programs may also increase the business performance in the organizations where production depends on employee service production capability. Therefore, a training and development program can be seen as a key factor in achieving organizational aims and strategic goals [2]. However, it is important to note that training is aimed to increase the technical job capabilities of lower level employees who require acquiring technical knowledge and skills; on the other hand development is aimed to increase the job capabilities of administrators or those working at the managerial level [3]. It has been argued that employees participated in any training and development program are supposed to feel better, happy and productive during the work. By providing the knowledge and skills employees need, training and development programs have help to increase employee motivation, satisfaction and retention particularly for those working in the frontline employees.

Against the background briefly presented above it emerges that understanding the implications of training and development programs on employee motivation is important. In this respect, the aim of this study is to understand whether the employee evaluation of training and development programs and motivation differs in terms of some independent variables such as participation in those programs and employee working experience. The results may be helpful for increasing the competitive advantage of businesses in the long run.

### 1.1. Training, Development and Motivation

The term "training" indicates the process involved in improving the aptitudes, skills and abilities of the employees to perform specific jobs [4]. It can successfully be used in updating old talents and developing new ones. It is a requirement for successful candidates placed on the jobs to perform their duties effectively. Alongside its four objectives, namely; individual, organizational, functional, and social, its principal objective is to assure the availability of a skilled and willing workforce to the organization [5]. Specific objectives contributing to both employee and organizational effectiveness are met by employee development programs. The aim of training and development is to develop competences such as technical, human, conceptual and managerial for the improvement of both individual and organization growth [6].

The motivation which can be significantly enhanced by training and development programs has an important role in influencing the employees to accomplish individual as well as the organizational goals. It is a voluntary use of high-level self-regulated learning strategies, such as paying attention, connection, planning, and monitoring [7]. It represents those psychological processes that cause the arousal, direction and persistence of voluntary actions closely related to the goal [8]. It involves psychological processes that culminate in an individual's desire and intentions to act in a specific way. It is generally defined as a series of energizing forces originating both within and beyond an individual's self while working [9]. The nature,

---

<sup>1</sup>Corresponding author: Erciyes University, Faculty of Tourism, 38039, Kayseri, Turkey, kgullu@erciyes.edu.tr

<sup>2</sup>Adana Science and Technology University, Faculty of Tourism, Adana, Turkey, ocelik@adanabtu.edu.tr

<sup>3</sup>Private Sector, Kayseri, Turkey, tugcegullu04@gmail.com

<sup>4</sup>Turkey Is Bank, Ankara, Turkey, Hamdi.Bayram@isbank.com.tr

intensity and duration of a person's work behaviour is determined by such forces and thus influence their productivity and performance. Also, motivation helps in supporting employees and encourages them to work hard and accept the training and development programs to improve their capabilities to ensure developing their skills, and to understand the required work environment and surrounded circumstances. On the other hand, these practices will also help in understanding the need of information technology and how to use it which helps in improving the quality of internal service by implementing a support system [10].

## 1.2. Internal Marketing Concept

The term internal marketing seems to have been initially used by Berry et al. in 1976 [11]. The concept broadly means attracting, developing, motivating, and retaining qualified employees through job-products satisfying their requirements. It is the philosophy of behaving employees as customers [12]. This term emerged out of the notion saying that employees make an internal market in the organization and this market needs training, teaching and motivating workers to satisfy needs and expectations of external customers [13]. It was created in 1970's as a method of administration to constitute, inculcate and provide good service [14]. It is any form of marketing inside an organization focusing staff attention on the internal acts that need to be changed with an intention to enhance external market performance and employees are encouraged to become highly motivated players in the corporate's strategy [15],[16]. One of the main aims of IM [17] is to develop an internal customer service orientation inside the organization and hence an IM approach provide opportunities to focus marketing concepts and methods on internal organizational audiences. Fisk et al. [18] stated that the IM concept consists of two basic ideas, and origins of both ideas came to the surface in the early services literature: The first idea is that everyone in the organization has a customer, so everyone in the organization has someone whom he or she must serve. The second idea is that internal customers must be kept happy in their jobs before they can efficiently serve the end customer. Dunne and Barnes [19] describe how an IM program should create four highly related elements: motivation of employee, job satisfaction, job involvement and organization loyalty.

The essential elements of internal marketing can be described as employee motivation and satisfaction, customer orientation and satisfaction, inter-functional co-ordination and integration, and implementation of specific corporate or functional strategies [20]. Five aspects of internal marketing: training, administrative support, internal communication, external communication, human resources management, communication and training and development have been identified by Change and Change [21].

Ways of knowledge creation and sharing like training and development play a key role in reducing role ambiguity, increasing self-efficacy, building relationships and reducing perceived fences to new conducts [22]. Training, development and education undertake numerous essential functions in the delivery of high-quality services and is typically a main element of an IM approach [23],[24],[25]. Excellent key elements of internal marketing in service sector can be explained as training programs, performance incentives and vision [26]. Virtually all definitions of internal marketing practices put emphasis on the importance of training since frontline employees need the necessary knowledge and ability to perceive and cope with problems and to ensure superior-quality goods and services [27].

## 2. LITERATURE REVIEW

Oatey [28] has examined that training develops a person's skill at a particular task. It contributes socially, intellectually and mentally in developing an employee, which is very essential in facilitating the level of productivity as well as the personnel development in an organization. Oribabor [29] expressed that training and development targets at developing competences such as technical, human, conceptual and managerial for the development of personal and organization growth. Campbell and Kuncel [30] and Wright and Boswell [31] suggested that application of training has positive impacts on not only individual performance of employees but also organizational performance. Bates and Davis [32] have investigated that the training program is useful only if the trainee can practice the conceptual knowledge which are learned in training programs in a real job circumstances. In a research on the employees of the banks and institute employees Khan [33] and Khan et al. [34] have studied that the training has the positive impact on the employee performances. Naong [35] inquired the effect of training and development on motivation for employees having low level of education. In his study on employees in five companies in South Africa, he came to an conclusion that employees participating more in training and development programs are motivated more than those participating less in such programs. In a study on a commercial bank in Jordan, Al-Hawary et al. [36] examined the effect of internal marketing in its four aspects: training and development, motivation, communication and empowerment, on Job satisfaction. In this study, training and motivation has been positively related to employee's job satisfaction.

## 3. METHODOLOGY

### 3.1. Development of Hypotheses

In the light of the literature, we argue that evaluations of employees on motivation differ based on some characteristics and propose the hypotheses following:

H<sub>1</sub>: Evaluations of employees on motivation differ in terms of situation of participation.

H<sub>2</sub>: Evaluations of employees on motivation differ in terms of number of participation.

H<sub>3</sub>: Evaluations of employees on motivation differ in terms of experience in sector.

### 3.2. Research Goal



This study aims to identify the differences of training and development on motivation of employees. The prime focus of this study is to identify the differences of employees' evaluations who participate in training and development programs in banking sector. To measure the employees' evaluation and identify the differences of training and development on employee's motivation, some statistical tools or techniques like Independent-samples t test and ANOVA are applied on data.

### 3.3. Data Collection

The instrument used for data collection is questionnaire which is the primary source of data collection. The population of the current study was determined from a bank that uses training programs for its employees and has branches mostly in Kayseri in Turkey. Respondents consist of 320 employees working at different levels in the 21 bank branches which are located in Kayseri in June 2015. The survey aimed to reach the whole population, but it was obtained 243 usable questionnaires. So the return rate of the survey is approximately 76%. Firstly, a questionnaire was designed as electronic format and principal data collection instrument including various types of questions to determine. Later, electronic questionnaire was conducted with those working at some different levels positions of 10 bank branches in Kayseri. Subsequently, a pilot study was also conducted with sample representing the targeted population.

### 3.4. Measures

The questionnaire has 24 propositions which are related to evaluate the training and development program and has 20 propositions which are related to determine the motivation levels on a five-point Likert type ordinal scale (1=strongly disagree and 5=strongly agree). The scale which is related to evaluate the training and development program consists of four levels, i.e: reaction, learning, behaviour, results. The scale is based on a model developed by Kirkpatrick in 1959 [37] and later used by Naong 2009 [38]. This model has been cited by many scientific studies later and has been a model preferred in related studies Eroğlu, 2006 [39], Lopes 2006 [40], Kırçı 2007 [41], Şen 2010 [42], Göllü and Kayı 2014 [43] and Güllü 2015 [44] have used the scale to determine the level of motivation. The propositions which are related to determine the motivation levels were created through the scale development process for reliable and valid measurement [45], [46], [47], [48]. Cronbach's alpha reliability coefficient was calculated as 0.98 and reliable scale was found for the scale.

The questionnaire was sent to e-mail addresses of employees and was applied by the e-mail survey on internet. Once the data was collected, the following analyses had been conducted: (a) Independent-samples t test is the statistical technique which is applied on data to compare the means of "participants" and "non-participants" for last one year, (b) ANOVA is the statistical technique applied on data to compare the means of the groups of employee's motivation based on the characteristics "number of participation" and "characteristics experience" in sector for last three years. The results of the primary data and the discussions based on the above mentioned analyses are given in the section below.

## 4. RESULTS AND DISCUSSION

Characteristics of the participants would be summarized as follows. There are 243 employees who participated in the survey. While two-third of the participating employees in the survey is male, one-third of them is female. It is also observed that three-quarter of the participants consists of singles. Almost all of the participants are university graduates.

### 4.1 Differences in Evaluations Employee's Motivation

There is one hypothesis ( $H_1$ ) that is being tested by using Independent-samples t test and two hypotheses ( $H_2$ ,  $H_3$ ) that are being tested by using One-way ANOVA. The aim is to analyze the differences of the evaluations on training and development programs on motivation by "situation of participation", "number of participation", "employee's title", "gender", "marital status", "age", "educational level", "experience in bank" and "experience in sector" in training.

In other words, the aim of this section is to obtain the evaluations on training and development programs on motivation as the dependent variables and "situation of participation", "number of participation", "employee's title", "gender", "marital status", "age", "educational level", "experience in bank" and "experience in sector" as being the independent variables. To do that, ANOVA Analysis and Independent-samples t test have been applied to the data. As the results of these tests indicate, the perceptions of respondents on evaluations of training and development programs on motivation differ in "situation of participation", "number of participation" and "experience in sector". No significant differences were found for other (employee's title, gender, marital status, age, educational level and experience in bank characteristics. For this purpose following statistical hypotheses ( $H_1$ ,  $H_2$ ,  $H_3$ ) have been tested.

#### 4.1.1. Independent-samples t test

Independent-samples t test compared the means of participants and non-participants (Table 1) with the value of t and the significance level for last one year. The means, values of t and significance levels are listed in the table. Independent-samples t test reveals that there are statistically significant differences among the evaluations of employee's motivation based on situation of participation ( $t=8,473$ ,  $p=,006$ ). From the results obtained the p-value ,006 is less than the significant level ,05 and the alternative hypothesis is accepted (rejects a null hypothesis) if the p-value is less than ,05. Employees in situation of participation, participants ( $M= 4,02$ ) indicated the employee's motivation to a significant greater degree than non-participants ( $M= 2,96$ ). Evaluations of employees on motivation differ in terms of situation of participation. The hypothesis  $H_1$  is accepted.

$H_1$ : Evaluations of employees on motivation differ in terms of situation of participation.

Table 1. Differences in Evaluations Employee's Motivation Based on Situation of Participation for Last one Year

	Means		T	Sig.(2-tailed)
	Participants	Non-participants		
Employee motivation	4,02	2,96	8,473	,006

The independent-samples t test indicated that there are significant differences in the means of participants and non-participants depending on evaluations of employee's motivation. According to the results, participants who participated in the training and development programs reach to a higher level of motivation compared to participants who did not participate in this program.

#### 4.1.2. ANOVA

ANOVA was used to compare the means of the groups of employee's motivation based on the characteristic of number of participation for last three years.

H<sub>2</sub>: Evaluations of employees on motivation differ in terms of number of participation.

Table 2 shows ANOVA comparing the means of number of participation of employees who completed the survey. The means, values of F and significance levels are listed in the table. Tests of ANOVA reveal that there are statistically significant differences among the evaluations of employee's motivation based on number of participation (F=6,276, p=,000). From the results obtained the p-value ,000 is less than the significant level ,05 and the alternative hypothesis is accepted (rejects a null hypothesis) if the p-value is less than ,05. Employees in number of participation, more than twice (M= 4,091) indicated the employee's motivation to a significant greater degree than once (M= 3,781) and twice (M=3,789). Evaluations of employees on motivation differ in terms of number of participation. The hypothesis H<sub>2</sub> is accepted.

Table 2. Differences in Evaluations Employee's Motivation Based on Number of Participation for Last Three Years

	Means				F	Sig.
	Once	Twice	More than Twice	than		
Employee motivation	3,781	3,789	4,091		6,276	,000

The results show a p value of 0.000 in Table 2, which is significantly high. From Table 2 (above), those respondents who received training and development programs, two or more times, reveal a significantly higher score in the motivation, than those respondents who received training and development programs, only once. According to the results, participants who received the training and development programs many times reach to a higher level of motivation compared to participants who received less programs.

ANOVA was used to compare the means of the groups of employee's motivation based on the characteristic of experience in sector for last three years.

H<sub>3</sub>: Evaluations of employees on motivation differ in terms of experience in sector.

Table 3 shows ANOVA comparing the means of experience in sector of participants who completed the survey. The means, values of F and significance levels are listed in the table. Tests of ANOVA reveal that there are statistically significant differences among the evaluations employee's motivation based on experience in sector of participants F=2,457, p=,046). From the results obtained the p-value ,046 is less than the significant level ,05 and the alternative hypothesis is accepted (rejects a null hypothesis) if the p-value is less than ,05. Employees in experience in sector of participants more than 20 years (M= 4,07) indicated they employee's motivation to a significant greater degree than less than one year (M= 4,07), 1-5 years (M= 3,55), 6-10 years (M= 3,80) and 11-20 years (M= 3,31). Evaluations of employees on motivation differ in terms of experience in sector. The hypothesis H<sub>3</sub> is accepted.

Table 3. Differences in Evaluations Employee's Motivation Based on Experience in Sector for Last Three Years

	Means					F	Sig.
	Less than 1 years	1-5	6-10	11-20	More than 20 years		
Employee's motivation	4,03	3,55	3,80	3,31	4,07	2,457	,046

According to the results, participants who have more experience in sector are reach to a higher level of motivation compared to participants who have less experience in sector.

## 5. CONCLUSION

This research was conducted to identify the employee evaluation who participate in training and development programs in banking sector. Participation in training and development programs is quite important for employees as internal customers. The aim is to analyze the differences of the evaluations on training and development programs on motivation by "situation of participation", "number of participation", "employee's title", "gender", "marital status", "age", "educational level", "experience in bank" and "experience in sector" in training. The study found that the perceptions of employees on evaluations of training and development programs on motivation differ in "situation of participation", "number of participation" and "experience in sector". No significant differences were found for characteristics such as employees' title, gender, marital status, age, educational level and experience in bank.

According to the results, participants; (a) who participated in the training and development program, are reach to a higher level of motivation compared to participants who did not participate in this program, (b) who received many times in the training and development programs, are reach to a higher level of motivation compared to participants who received less in this programs, and (c) who have more experience in sector are reach to a higher level of motivation compared to participants who have less experience in sector.

The results depend on differences show that training and development programs have positive impact on motivation of employees in banking sector. So it is concluded that if the employees participate in training and development programs, it can enhance the motivation of employees that is helpful in increasing motivation of employees as well as of organization.

Results of the study are strongly based on the literature review. Comparison of the results of the research done in different samples will be useful. Other studies should be done on a larger scope to compare this study with what is happening across the nation. Results are valid within the specified research limits, and it is impossible to make generalization.

## REFERENCES

- [1] Heskett, J. L., Jones, T. O., Loveman, G. W., Sasser, W. E. ve Schlesinger, L. A. (1994), "Putting the Service-Profit Chain to Work", *Harvard Business Review*, 164-174.
- [2] Carrell, M.R., Elbert, N.F., Hatfield, R.D., Grobler, P.A., Marx, M. and Van der Schyf, S. (2000). *Human Resource Management in South Africa*. Cape Town: Maskew Miller Longman.
- [3] Lunenburg, F.C. and Ornstein, A.C. (1991). *Educational Administration Concepts and Practices*. Belmont: Wadsworth Publishing Company.
- [4] Aswathappa, K. (2000). *Human Resource and Personnel Management*, New Delhi: Tata Mcgraw-Hill Publishing Company Limited
- [5] Kulkarni, P. P. (2013). "A Literature Review on Training & Development and Quality of Work Life *Journal of Arts*", *Science and Commerce*, 4 (2), 136-143.
- [6] Obisi, Chris (1996). *Personnel Management*, Jackbod Enterprises. Ojokondo Layout Agbowo, Ibadan.
- [7] Turner, J. C9. (1995). "The Influence of Classroom Contexts on Young Children's Motivation for Literacy". *Reading Research Quarterly*, 30, 3, 410-441.
- [8] Kreitner, R and Kinicki, A. (2004). *Organisational Behavior*. New York: McGraw-Hill.
- [9] Herselman, S. (2001). "Performance Motivation Among Employees of a Wholesale Company", *Journal of Ethnology*, 24(1), 1-10.
- [10] ELSamen, A. A. and Alshurideh, M. (2012). "The Impact of Internal Marketing on Internal Service Quality: A Case Study in a Jordanian Pharmaceutical Company", *International Journal of Business and Management*, 7(19), 84-95.
- [11] Berry, L.L., Hensel, J.S. and Burke, M.C. (1976). "Improving Retailer Capability for Effective Consumerism Response", *Journal of Retailing*, 52(3), 3-14.
- [12] Berry, L.L., and Parasuraman, A. (1991). *Marketing Services: Competing Through Quality*. New York: The Free Press.
- [13] Aburoub, A. S., Hersh, A. M. and Aladwan, K. (2011). "Relationship between Internal Marketing and Service Quality with Customers' Satisfaction", *International Journal of Marketing Studies*, 3, 2, 107-118.
- [14] Varey, R.J. and Lewis, B.R. (1999). "A Broadened Conception of Internal Marketing", *European Journal of Marketing*, 33, 9(10), 926-944.
- [15] Ballantyne, D., Christopher, M. and Payne, A. (1995) "Improving the Quality of Services Marketing: Service (Re) design is the Critical Link", *Journal of Marketing Management*, 2(1), 7-24.
- [16] Lehu, J.M. (2012). "L'encyclopédie Du Marketing" Eyrolles. Paris.
- [17] Smith, Anne (2011). *Internal Social Marketing: Lessons from the Field of Services Marketing*, *Open Research* [Online]. Available: <http://oro.open.ac.uk/31468/2/42.pdf> [23/09/2016]
- [18] Fisk, R.P., Brown S.W. and Bitner, M.J. (1993). "Tracking the Evolution of the Services Marketing Literature", *Journal of Retailing*, 69(1), 61-103.
- [19] Dunne, P.A. and Barnes, J.G. (2000). "Internal Marketing: A Relationship and Value Creation View", in R.J. Varey and B.R. Lewis (eds), *Internal Marketing: Directions for Management*, London: Routledge, pp. 192-220.
- [20] Rafiq, M. and Ahmed, P.K. (2000). "Advances in the Internal Marketing Concept: Definition, Synthesis and Extension", *Journal of Services Marketing*, 14, 6, 449-62.
- [21] Ching-sheng Change, H. and Hsin-Hsin Change (2007). "Effect of Internal Marketing on Nurse Job Satisfaction and Organizational commitment: Example of Medical Center in Southern Taiwan", *Journal of Nursing Research*, 15, 4, 265-274.
- [22] Schneider, B. and Bowen, D.E. (1985). "Employee and Customer Perceptions of Service in Banks: Replication and Extension", *Journal of Applied Psychology*, 70, 423-433.
- [23] Berry, L.L. and Parasuraman A. (1992) "Services Marketing Starts from Within", *Marketing Management*, 1(1), 24-34.
- [24] Foreman, S.K. and Money, A.H. (1995). "Internal Marketing: Concepts, Measurement and Application", *Journal of Marketing Management*, 11(8), 755-768.
- [25] Grönroos, C. (1990). "Relationship Approach to Marketing in Service Contexts: The Marketing and Organisational Behaviour Interface", *Journal of Business Research*, 20(1), 3-11.
- [26] Tsai, Y. and Tang, T. (2008). "How to Improve Service Quality: Internal Marketing as a Determining Factor", *Total Quality Management and Business Excellence Review*, 19, 1117-1126.
- [27] Pfeffer, J. (1998). "Seven Practices of Successful Organizations", *California Management Review*, 40, 96-124.
- [28] Oatey M. (1970). "The Economics of Training with Respect to the Firm", *British Journal of Industrial Relations*, 8, 1-21.

- [29] Oribabor, P. E. (2000). "Human Resources Management, A Strategic Approval", *Human Resources Management*, 9 (4), 21- 24.
- [30] Campbell, J.P. and Kuncel, N.R. (2001) Individual and Team Training. In: Anderson, N., Ones, D.S., Sinangil, H.K. and Viswesvaran, C. (eds), *Handbook of Industrial, Work & Organizational Psychology*, 2, 278-312.
- [31] Wright, P. and Boswell, W. (2002). "Desegregating HRM: a Review and Synthesis of Micro and Macro Human Resource Management Research". *Journal of Management*, 28, 3, 247-276.
- [32] Bates, Donald L. and Davis, Tammy J. (2010), "The Application Bridge: A Model for Improving Trainee Engagement in the Training Process", *International Journal of Management*, 27, 3, 770-776.
- [33] Khan, M., I. (2012). "The Impact of Training and Motivation on Performance of Employees", *Business Review*, 7, (2), 83-95.
- [34] Khan, R. A. G., F. and Khan, M. A. (2011). "Impact of Training and Development on Organizational Performance", *Global Journal of Management and Business Research*, 11(7), 63-68.
- [35] Naong, M. N. (2014). "Impact of Skills-Development Training on Lower-Level Employee's Motivation and Job Satisfaction – A Case-Study of Five South African Companies", *Mediterranean Journal of Social Sciences*, 5, (20), 369-380.
- [36] Al-Hawary, S. I. S., Al-Qudah, K. A. M., Abutayeh, P. M., Abutayeh, S. M. and Al-Zyadat, D. Y. (2013) "The Impact Of Internal Marketing On Employee's Job Satisfaction of Commercial Banks in Jordan", *Interdisciplinary Journal of Contemporary Research in Business*, 4(9), 811-826.
- [37] Kirkpatrick, D. L. and Kirkpatrick, J. (2013). *Kirkpatrick Four Levels Audio Recordings Study Guide*, LLC: Kirkpatrick Partners.
- [38] Naong, M. N. (2014). "Impact of Skills-Development Training on Lower-Level Employee's Motivation and Job Satisfaction – A Case-Study of Five South African Companies", *Mediterranean Journal of Social Sciences*, 5, (20), 369-380
- [39] Eroğlu, U. (2006). İşletmelerde Eğitim Faaliyetlerinin Etkinliğinin Ölçümüne İlişkin Bir Model Önerisi, *Yönetim Bilimleri Dergisi*, *Journal of Administrative Sciences*, 4 ( 2), 111-132.
- [40] Lopez, T. (2006). *Differences in Career Motivation Between International and Domestic Graduate Students*, Pennsylvania State University PhD Dissertation, USA: Pennsylvania State University.
- [41] Kırçtı, Z. (2007). *Motivasyon Unsuru Olarak Kariyer Geliştirme ve Bir Uygulama*, Atatürk Üniversitesi Sosyal Bilimler Enstitüsü, Erzurum: Basılmamış Yüksek Lisans Tezi.
- [42] Şen, O. (2010). *E-sertifika Programlarının Çalışan Motivasyonuna Etkisi: Anadolu Üniversitesi Perakendecilik E-Sertifika Programının Motivasyona Etkisi ile İlgili Bir Araştırma*, Eskişehir: Osmangazi Üniversitesi, Sosyal Bilimler Enstitüsü, Yüksek Lisans Tezi.
- [43] Göllü, E. ve Kayı, A. (2014). *Impact of Personal Development Trainings on Employee Motivation: A Case Study From Turkish Pharmaceutical Sector*, *The Journal of International Social Research*, 7 (33), 635-642.
- [44] Güllü, T. (2015). *Eğitim ve Geliştirme Programlarının Çalışanların Motivasyonuna Etkisi ve Bankacılık Sektöründe İncelenmesi*, Nuh Naci Yazgan Üniversitesi Sosyal Bilimler Enstitüsü, Basılmamış Yüksek Lisans Tezi.
- [45] Gerbing, D.W. and Anderson, J.C. (1988). *An Updated Paradigm for Scale Development Incorporating Unidimensionality and Its Assessment*. *Journal of Marketing Research*, 25,186-192.
- [46] Hinkin, T.R. (1995). *A review of Scale Development Practices in the Study of Organizations*. *Journal of Management*, 21, 967-988.
- [47] Hinkin, T. R., Tracey, J. B., and Enz, C. A. (1997). *Scale Construction: Developing Reliable and Valid Measurement Instruments*. *Journal of Hospitality and Tourism Research*, 21(1),100-120.
- [48] []. DeVillis, R. F. (2014). *Ölçek Geliştirme Kuram ve Uygulamalar*. (Çeviri Editör: Tark Totan). Üçüncü Basımdan Çeviri. Ankara: Nobel Yayınları.

# Effect Of Social Capital On Innovative Formations And Innovativeness Ability Of Institutions: A Research About A State And A Foundation University Provide Training In Konya

*E.Nihan Cici Karaboga<sup>1</sup>, Nezahat Kocyigit<sup>2</sup>, A.Elif Yazgan<sup>3</sup> Kazım Karaboga<sup>4</sup>*

---

## Abstract

*Globalization world, developing technology, changing working conditions and organizational settlements put forward as the elements carrying importance in the development of environments the concepts such as social capital which the newness and these newness in the management will come true. With this study, the universities and their personals being from the essential authoritative of the quick changing and developing duration are subjected to the study.*

*The purpose of the study in this frame is to search to the social capital and newness applications of the effect of within the administrators of universities in Konya province. In this study being the first stage of the search, the state university will be referred forming the Dynamics of the city and giving education in Konya Province. By studying the data obtained to effect in appearing of newness applications of social capital and investigation findings, according to these data it will be determined to be enlarged of studying to other universities in the city. It is hoped to contribute in accordance with the suggestions which will suggest to the researches and the administrators with the results obtained.*

*As the foundation university have gone through restructuring, we come across with some problems with the collection of data. Hence only the state universities will be analyzed in this work as their data available. The data comparison of the state and foundation universities will separately be analyzed in the following work.*

**Keywords:** *Social Capital, Newness Formations, The capacity of newness*

---

## 1.THEOROTICAL FRAMEWORK

The concept of social capital emerged as one of the social and economics concepts which ever-increased the importance. The concept of social capital is evaluated as a factor directly related to the achievements in the economic, political and social fields of a country [21]. Especially, rapid increasing of the studying in literature in last 15 years provide opportunity generating new alternative policies in order to solve the social and economic problems of the societies more easily. This is because by using efficiently the material production factors which the countries have is directly proportional between with the social capital savings [12].

In activity of operation of democracy and market economy as well as much more important “doing the work together” and “power of sharing” which the social capital stock formed, if these become weak, the adequacies will be able to appear in the applications of democracy and productivity at the market economy. A strong social capital generates power of doing the work together. The social capital will also significance and increase with being used productively as well as in the other capital assortments [5].

The economic activities affection power of the social relations about society caused to appear the concepts of the social capital. With this concept, it was determined that the social links amongst the human beings such as financial capitals had a active power, by feeding with the factors such as newness ability at this power, it was established with the workings done that it was an active power for institutions.

If it was started to be heard the name of the social capital concept at late years, the background mentioned for social capital endured to the anterior. As a sociological factor, social capital important and activity in the social improvement was endured to the anterior by the social scientists. Many doctrinaires such as Adam Smith Karl Marks, Emile Durkheim, Thorstein Veblen and Max Weber attracted attention to the effect on being analyzed of the economic growth and social problems and studied a lot of labors in this field [21]. But the literatures which examined religiously the topic of social capital even which concentrated

---

<sup>1</sup>Corresponding author: Necmettin Erbakan University, The School of Applied Sciences, Abdülaziz Mh. Abdülmümin Sk. No:16 Meram/Konya, Turkey. [emihancici@konya.edu.tr](mailto:emihancici@konya.edu.tr)

<sup>2</sup>Necmettin Erbakan University, The School of Applied Sciences, [nkocyigit@konya.edu.tr](mailto:nkocyigit@konya.edu.tr)

<sup>3</sup>Necmettin Erbakan University, The School of Applied Sciences, [aelifyazgan@gmail.com](mailto:aelifyazgan@gmail.com)

<sup>4</sup>Selcuk University, [kazimkaraboga@selcuk.edu.tr](mailto:kazimkaraboga@selcuk.edu.tr)

on the economic dimension were seen to increase in 1990's. Similar studies we can give examples are Portes and Sensenbrenner 1993; Putnam 1995; Labonte 1999, and Bankston and Zhou [12].

The first studies of social capital concept within literature based on the social science. The researches were done to highlight the importance of the power networks about society, to semitize the causes of weakness in the personal relationship and to semitize evolutionary process which the collective behaviors in the societies experienced and to search what the role of social capital was. Nevertheless, examining at the individual level of social capital concept is found generally in the family relationship being efficient in growing of the children and in the working order of social organizations forming in the society. The researches done in this area established that social capital as a social phenomenon the role of efficient the intellectual capital improvement is so big besides the plants taking part inside the civil organizations of society is much more level of the efficient role on economic performance [14]. Relationship of many important concepts for managements was semitize with the social capital and one of the concepts also became newness.

Age of social and economic change duration make the organizations continue their activities in the dynamic and intense environment. In such an environment the newness for managements forms the essential source of getting competitive edge [10]. Those which done for using of the employees productively and actively towards their purposes of organizations change and increase every day in order to get a success on the newness level existing in world and in order to keep with circumstances changing so rapidly. Consequently, for the managements the subject of newness which sense of rule nowadays bring along became one of the strategies besides competition elements such as quality, expenditure and speed. Newness also was examined in a differential manner such as production and duration newness, radical and gradual newness, organizational newness, technological newness.

In the Turkish literature related to subject, "rawness, modernism, regeneration" and "innovation" words produced by the Turkish Language Association are used. In the examination done, at a large part of academic studies done in this area, it was seen that the words of "rawness" or "innovation" used and also using these words were embraced in this study. Zaltman, Duncan and Holbek remarked that there are idea, product and practical which will be perceived as new by the implementers of innovation in 1973. Similarly, in the study in 2005 of Erdil and his friends they described as being developed, being appropriated and being applied of new ideas, duration, product and services. Nevertheless, according to Yu's study in 2001, being perceived an opinion as new starts by reacting of the person against that opinion. According to the strategical researchers, the rawness concept seen as changing a commercial benefit by taking an opinion of a promote, as striking out of a genius evaluate as "once not particular, quotable and a systematize able duration nowadays. The researches related to innovation [10] being whole thing of the planned studies done "to form new product and services or to provide new usage areas to the existing product and services increased both in world and in our country in late years by coming into prominence due to existing competition circumstances. The studies done says that especially at this success the countries and managements going forward in a short time, innovation and its understandings are found.

The importance of social capital stands out in the component of being developed the innovation behaviors of the employees, the essential assumption of social capital is to join the much more sharing than the existing level of source and knowledge with the interaction of individuals [11]. If in other words, we can say that it will facilitate the things of management in this subject and will provide active working of sharing idea network and knowledge about organization for social capital [1]. Rawness is a big and efficient phenomenon not to be connected to the sparkle of a person therefore it is a duration coming into the open with the knowledge forming by the connection of Networks. The social relationship of the employees who work in the managements make the sharing knowledge desire increase and make the uncertainty decrease [3]. The increasing at safety amongst employees and being willing taking risk is encouraged them towards giving an opinion more easily and this, however, forms to spread more quickly and more easily inside the organization of newness [16].

If knowledge is compared with iceberg, the explicit knowledge forms little part of iceberg that is, however the visible part covered knowledge forming main big part of iceberg and can be told as invisible part staying under water. The covered knowledge involves the technical and capacity knowledge. Covered knowledge can be shared to provide internal motivation such as friendship and social links. Choi and Lee's work in 2003, by telling to standing to gain with social interaction the personal experience and covered knowledge, In the Nonaka's study related to the subject in 1994, He tells that the covered knowledge is private and is shared by social interaction. Therefore, it is expressed that the social relationship facilitates the sharing of covered knowledge amongst the employees in the organization. The covered knowledge is a knowledge that a

person hosts and can be not aware of it exactly even himself and it is expressed as an important source causing to earn to the individual, organization or group competition advantages. Since it is proprietary, it is important and peerless [19].

Difficulty of being imitated by the competitors of the covered knowledge causes to be an important source for sustainable competition advantage of it. Individual's addition of the covered knowledge to the team success cannot be measured exactly [15].

Sharing of the covered knowledges and innovator behaviors exhibited are expressed solemnly due to causing to earn competition advantage in the outside word for the organization. A person who develop new concepts can focus on maintaining the existing instead of looking for after a while due to negative reactions the innovator behaviors responded by his circumference. Putting forward his ideas and switching to apply these ideas of a person who thinks that he will not be isolated conversely will be supported due to his different ideas. In coming true of these ideas, the relationally social capital contains the elements such as confidence, norms and sympathize, being a valuable source embedded to the connections brings forward importance [19].

In Amabile and his friends' work done in 1996, they established that the social environment increases the frequency and level of innovator behaviors environment and and they expressed that the climate demonstrate the signals received intended for

behaviors that the individuals displayed and potential results of these behaviors. The individuals use these signals in the formulation of organizational expectations [17].

Innovation ability also carries great importance in higher education institutions as well as in all managements operating at different fields. The higher education institutions pass from the activities to be an institution preferred, to be successful at general literature and to enter between the world ranking. The speed of keeping up with changing and developing world of the universities is directly proportional with the rawness administration success. Therefore, it was thought that having an innovator structure will be related to the social capital concept to accomplish of a institution whose capital is human and this study was prepared by establishing on studies done at this subject.

In the field literature, the searches done in this subject (Scott and Bruce,1994; Tsai and Ghossal, 1998; Naphet and Ghossal, 1998; Lena and Van Burren, 1999; Köhler et all, 2010; Çalışkan et all, 2011; Xerri and Brunetto, 2011; Mura et all, 2012) put forward that it is efficient on the social capital and innovator behavior [18]. In this context, this study treats relationally social capital, covered knowledge sharing behavior and the innovator behavior variables and puts forward the importance of relationally social capital in the covered knowledge sharing and in the innovator behavior exhibiting. But within this context, not being done a study in the higher education institutions, it increases the importance of the study. Besides it is true that the findings reached as a result of the study will be able to contribute to the strategical plans of universities.

## 2. METHODOLOGY AND DEMOGRAPHIC RESULTS

The search forms executive personals of a state university getting active in Konya province. Since the purpose of our search is to express the relations causals between the variables treated, the participants meet this expectation. The questionnaire method will be used as a data collection method.

Social Capital Scala: The scale prepared by Göksel et all (2010), by collecting from Nahapiet and Ghosal (1998), Moran and Ghosal (1996) and Tsai and Ghosal (1998), covered knowledge sharing behavior dimensions was adapted by collecting from Bock et all (2005) study, nevertheless to measure the rawness administration in the institutions, the rawness administration scale which [4] developed in the school was used.

The questionnaire used in this study forms from 2 main dimension. The first dimension forms from demographic questions. The second one forms three sub-dimensions. These sub-dimensions form from the innovation, social capital and knowledge sharing behavior scales. Likert scale is formed from total 61 interrogative expression. The quinary Likert scale was used in the collecting data tool.

The study generally aims at to measure the efficient on the innovation capacities of social capital and knowledge sharing behaviors in the higher education institutions. This study was applied to the executive personals of a state university being active in Konya province. Generally there are total 66 directors and deans in university. It was reached to 30 directors with in the research. This shows that approximately percent 46 personal are reached. It can be said that this rate is generally representing ability the main group.

Table 1. Demographic Features

Demographic Features		Count	Percentage (%)
Sex	Male	22	73,3
	Female	8	26,7
	Total	30	100
Age	20-30 age	1	3,3
	31-40 age	10	33,3
	41-50 age	12	40
	51-60 age	7	23,3
	61 age and over	--	--
	Total	30	100
Marital Status	Married	26	86,7
	Single	4	13,3
	Total	30	100
Period of Service	0-10 year	10	33,3
	11-20 year	3	10
	21 year and over	17	56,7
	Total	30	100
Period of Directorate	0-5 year	9	63,3
	6-10 year	19	30
	11-15 year	2	6,7

	16 year and over	--	--
	Total	30	100
Administrative function	Dean/Manager	9	30
	Deputy Dean / Deputy Manager	21	70
	Total	30	100

When examining the table above it is found that the large majority of directors consist of married men at middle age and over. When examining the periods of service, it can be said that the large majority of them have served during 21 years and over and have managership experiment only one period (four or five years). It is found that the majority of participants consist of deans and director assistant.

### 3. THE SIGNIFICANCE LEVEL OF INNOVATION ABILITY, SOCIAL CAPITAL AND KNOWLEDGE SHARING BEHAVIOR DIMENSIONS

In this part, it was measured by Friedman Test the severity ratings between the participation levels of the answerer to the statements at the Likert scaled dimension.

Table 2. The innovation ability scale importance ranking.

THE INNOVATION ABILITY SCALA IMPORTANCE RANKING			
	N	Mean	Std Deviation
The directors of our school have motivation power by impressing their employees	30	4,40	0,81
The directors of our school know their employees very well and they decide who can solve the thing with which method.	30	4,37	0,81
The directors of our school have a strong vision at the process of change	30	4,30	0,79
The directors of our schools give those doing successful study a reward	30	4,30	0,79
The directors of our school encourage the employees to embrace the rawness	30	4,27	0,64
It is provided to make the employees join the duration actively in the decisions of change which will be taken in our school	30	4,23	0,94
The directors of our school appreciate those being successful at their work	30	4,23	0,90
Decisions and applications taken at change process in our school are suitable existed ethic and moral criterions	30	4,20	0,81
The directors of our school carry out the feed back to their employees without hindering and doesn't allow breaking of communication	30	4,20	0,92
The directors of our school concentrate on applications buttressing ascent aims of employees at their careers	30	4,20	0,85
The directors of our school support the team working of employees to study together around a common key of the solution	30	4,17	0,70
The directors of our school play pathfinder role to accommodate the school culture and change process of employees who come to school new	30	4,17	0,99
The directors of our school help me in solving the predicaments related to my work	30	4,17	0,83
Many people are glad from interpersonal communication at change process in our school	30	4,10	0,92
Employees are submitted their different abilities presentation environment at change process	30	4,07	0,64
The directors of our school demonstrate sensitivity about following up of the different done.	30	4,07	0,78
The director of our school appreciate the person at the end of task completed with success.	30	4,07	0,69
It is gained admission that collaboration instead of competition is the best productivity way in our school.	30	4,03	0,67
The decisions and applications taken in our school coincide with each other at change process.	30	4,03	0,89
The directors of our school demonstrate sensitivity the school environment at change process.	30	4,03	0,72
The directors of our school share the leadership and strengthen the employees for school development.	30	4,00	0,69
The directors of our school often communicate face to face with employees at change process.	30	3,97	0,81



The directors of our school strain to motivate the employees towards change aims.	30	3,97	0,81
The school administration explain the need for change in a clear way	30	3,80	1,00
The directors of our school demonstrate sensitivity about following up of the different done.	30	3,57	1,14
Notes : (i) n= 30, (ii) at scale 1= I don't certainly join and 5=I certainly join, mean (iii) According to Friedman's two-way Anova Test percent 2 = 63, 330; p<0,001The results are significant in statistical respects.			

According to the directors joined in to the study, the rawness capacity of university is in the sufficient level ( $\mu$ : 4,12). According to the result of Table 2 (innovation ability) the highest participation by the answerers happened to the statement "The directors of our school impress their employees and have making them set in motion power," ( $\mu$ :4,40), nevertheless the lowest participation happened to the statement "There is an efficient communication system between school and environment," ( $\mu$ :3,57).

Table 3. Social Capital Scala Importance Ranking

Social Capital Scale Importance Ranking			
	N	Mean	Std. Deviation
There exists communication channels which we can share our knowledges with the others.	30	4,21	0,90
The communication channels provide opportunity accessing the knowledges that all other persons have.	30	4,17	1,04
If i share my problems with people here, they will react constructively and related.	30	4,17	0,71
The communication channels provide opportunity to joining to communication network easily of person and units which want to share their knowledges.	30	4,10	0,90
The communication channels provide opportunity to distributing of the knowledge's existed at different units and persons.	30	4,07	0,75
The communication channels have persons and units which will realize the knowledge sharing in large quantities and at extensive quantity.	30	4,03	0,94
We put emotional invest to each other here at noticeably scale in personal relationship.	30	4,03	0,87
Willingness and openness to knowledge sharing and communication are shared values.	30	4,03	0,82
Success stories told become guide in generating of values and knowledge, in sharing of them and in keeping them in a place for individual and units.	30	4,00	0,96
The system of communication provides opportunity to being delivered the knowledges coming from different person and units to the other persons in time.	30	3,97	0,98
The communication network provides opportunity to be informed the persons existing inside the communication network from the possibilities of sharing and delivering their knowledges.	30	3,97	0,78
There is an understanding which supports the teamwork and helping each other.	30	3,97	0,78
Willingness and openness values to knowledge sharing, communication here motivate me to act at this direction.	30	3,97	0,68
The communication channels provide opportunity to sharing of knowledges existing at different person and units.	30	3,86	0,69
The common language which we use provide convenience in getting new knowledges from the existing knowledges.	30	3,86	0,88
Openness to comments and different ideas is a sharing value.	30	3,86	0,88
The common language which we use provides activity in getting and in interpreting and in understanding the sharing and having knowledges.	30	3,79	0,90
Not written rules support the knowledge sharing.	30	3,79	1,01
Organizational understanding provides opportunity to consisting of communication and relations based on the different individual and culture values.	30	3,76	1,06
We use a common language consisting of facility statements and words which we will understand and communicate each other.	30	3,76	1,06
We can speak freely the difficulties i suffer in my work place and they also want to listen to me.	30	3,76	0,87
If some people here are transferred somewhere, both they and we feel loneliness.	30	3,76	0,87
We have a sharing relationship with people here. We can share freely our ideas, our emotions and our hopes.	30	3,72	0,75
I find consonant with values sharing here with my values.	30	3,69	0,97
Willingness and openness to knowledge sharing and communication necessitate me to act similarly.	30	3,48	0,91

I can see myself as a whole with the people here.	30	3,48	0,99
Notes : (i) n=30, At Scale 1 = I don't certainly join and 5=I certainly join (iii) According to the Friedman's two-way Anova Test, percent 2, 59,009; p<0,001 The result are significant in statistical respect.			

According to the directors who participate in the study, knowledge sharing behavior level is in the sufficient level ( $\mu$ : 3,90). According to the results of Table 3 (social capital), the highest participation by the answerers happened to statement "There exists communication channels which we can share our knowledge with the others," ( $\mu$ :4,21), nevertheless the lowest participation happened to statement "I can see myself as a whole with the people here," ( $\mu$ :3,48).

Table 4. Sharing Knowledge Scala Importance Ranking

Sharing Knowledge Scala Importance Ranking			
	N	Mean	Std. Deviation
I can see myself as a whole with the people in institution	30	4,07	0,74
Wilnesness and openness for communication and knowledge sharing are sharing values	30	4,03	0,72
Openness to comments and different ideas is a sharing value	30	3,87	0,82
I find coherent the values in the institution whit my values	30	3,83	0,65
I also route to behave at this direction the willingness and openness values to communication, knowledge sharing	30	3,77	0,68
Not written rules support the knowledge sharing	30	3,67	0,96
The willingness and openness to communication and knowledge sharing necessitate me to behave similarly	30	3,67	0,96
People share with the other units most actively the speciality which they learn from their education and training	30	3,60	0,72
People often share with other group members their work experience or technical knowledge	30	3,57	0,97
People share with the others the ways which they use to solve the problems when required	30	3,57	0,82
Notes: (i), n=30, (ii) at scala= 1= I don't certainly join and 5 =I certainly join (iii) According to the Friedman's two way Annova Test, percent 2 = 25, 469; p<o,005 the results are significant in statistical respect.			

According to the directors who join into study, knowledge sharing behavior capacity of the university is in sufficient level. ( $\mu$ : 3,76). According to the Table 4 results (Knowledge Sharing Behavior), the highest participation by the answerer's happened to statement "I can see as a whole with the people in institution," ( $\mu$ : 4,70) and nevertheless the lowest participation happened to statement "People share with the others the ways which they use to solve the problems when required," ( $\mu$ :3,57).

#### 4. THE MODEL OF RESEARCH, THE ANALYSIS OF CORRELATION AND REGRESSIONS

As seen at the model below, the main purpose of the research is to be identified of efficient on the innovation capacity the variables of social capital and knowledge sharing behavior in the higher education institutions. According to this, it was tested that concepts of social capital and knowledge sharing behavior in-institution employees exist a positive efficient on the innovation capacity of institutions and rawness capacity of institution.

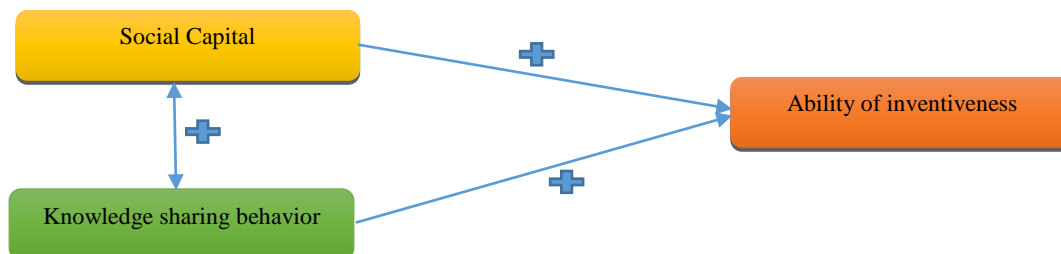

Core Hypothesis

H1: “Ability of inventiveness” and “knowledge sharing behavior” are positively efficient on “capacity of social capital”.

Table 5: Descriptive Statistics

Dimensions	Mean	Std. Deviation
Ability of inventiveness	4,12	0,65
Social Capital	3,90	0,47
Knowledge sharing behavior	3,76	0,60

Table 6: The Table of Correlation

Correlations				
		Ability of inventiveness	Social Capital	Knowledge sharing behavior
Pearson Correlation	Ability of inventiveness	1	0,716	0,843
	Social Capital	0,716	1	0,838
	Knowledge sharing behavior	0,843	0,838	1
Sig. (1-tailed)	Ability of inventiveness	.	0,00	0,00
	Social Capital	0,00	.	0,00
	Knowledge sharing behavior	0,00	0,00	.

Table 6 gives information about direction and intensity of relation between variables. By being used Pearson correlation coefficient in the relation analyze done, it was established existing of a positive and higher level relationship between variables. According to this, every treatment intended innovation capacity, social capital and knowledge sharing which the university included in to research will do can provide directly an increasing on the other variables. That is, it can be expected to improve the rawness capacity of university of new application about social capital and knowledge sharing that the university management will do.

Table 7: Model Summary

MODEL SUMMARY				
Model	R	R Square	Adjusted R Square	Std. Error of the Estimate
1	0,843	0,71	<b>0,688</b>	0,36038
a Predictors: (Constant), Knowledge sharing behavior, Social Capital				

When examining the Table 7, it can be said that the variables of social capital and knowledge sharing can be able to explain the variable of innovation capacity at the rate of percent 68.

Table 8: Anova

ANOVA (a)						
Model		Sum of Squares	df	Mean Square	F	Sig.
1	Regression	8,278	2	4,139	31,868	0,000b
	Residual	3,377	26	0,13		
	Total	11,654	28			
a Dependent Variable: Innovation Ability						
b Predictors: (Constant), Knowledge sharing behavior, Social capital						

Table 8 gives about meaningfulness of the regression model founded generally. When examining is table, it can be said that regression model founded generally is meaningfulness (F.31, 868 and p:0,00)

Table 9: Coefficients

COEFFICIENTS (a)					
Model	Unstandardized Coefficients		Standardized	t	Sig.

				Coefficients			
		B	Std. Error	Beta			
1	(Constant)	0,673	0,58		1,16	0,257	
	Social Capital	0,048	0,267	0,035	0,179	0,859	
	Knowledge sharing behavior	0,869	0,207	0,813	4,207	0,000	

a Dependent Variable: Innovation Ability

Table 9 generally puts forward which variables provide meaningful contribution to the model at the regression model being meaningful. Nevertheless, when examining the Table 9, it is found that the variable of knowledge sharing behavior contributes meaningful to the model. Nevertheless, the variable of social capital doesn't do meaningful efficient to the model in this study. According to this, it can be said that university management will directly provide an meaningful increasing to the university innovation capacity of systematic and new applications improving intended to knowledge sharing amongst the employees.

## 5. CONCLUSION

By taking the value which it deserved recently, social capital became a current issue of institutions and managements. Social capital is seen as a creative and intangible human resources staying outside the tangible assets of an institution. By going out the problem of production, it was found that the creative and innovation applications was needed in our age. Being realized of innovation applications by the employees denominated as a social capital prevented of being seen as on each robot of employees. In this sense, it is quite important to improve new applications intended to knowledge sharing of the universities which want to innovator programs, to produce innovator lessons contents and to produce talented human source between the social capital and employees.

The main purpose of this study is to analyze the efficient on the innovation capacity of university employees related to knowledge sharing behaviors of employees and social capital application. This efficient was measured with the correlation and regression analysis. According to this, it was established that existence of a positive relation between knowledge sharing behavior and innovation capacity and social capital.

## REFERENCES

- [1]. Adler, P. S., & Kwon, S. W. (2002). Social capital: Prospects for a new concept. *Academy of management review*, 27(1), 17-40.
- [2]. AMABILE, T. R., Conti, H. Coon, J. L., ve Herron, M. (1996), "Assessing The Work Environment for Creativity", *Academy of Management Journal*, 39, p. 1154- 1184.
- [3]. Bruton, G. D., Dess, G. G., & Janney, J. J. (2007). Knowledge management in technology-focused firms in emerging economies: Caveats on capabilities, networks, and real options. *Asia Pacific Journal of Management*, 24(2), 115-130.
- [4]. Bülbül, T (2012) Okullarda Yenilik Yönetimi Ölçeğinin Geliştirilmesi Geçerlilik ve Güvenilirlik Çalışması , Kuram ve Uygulama da Eğitim Bilimleri Dergisi , Cilt:12 , Sayı :1 ,168-174
- [5]. Çalışkan, D. (2010). Yenilikçi Oluşumlarda Sosyal Sermayenin Rolü ve Burdur İli Üzerine Bir Araştırma, Yüksek Lisans Tezi, Süleyman Demirel Üniversitesi Isparta.
- [6]. Cohen, D. ve Prusak, L. (2001). *Kavrayamadığımız Zenginlik. Kurul-lann Sosyal Sermayesi*. İstanbul: MESS Yayınları
- [7]. Eraslan, H. , Bulu, M. ve Bakan, İ. (). *Kümelenmeler ve İnovasyona Etkisi: Türk Turizm Sektöründe Uygulamalar, SÖİD Seyahat ve Otel İşletmeciliği Dergisi* 5 (3): 15-50.
- [8]. Erdil, Oya, Hakan Kitapçı, and Engin Turan. "ÖRGÜT KÜLTÜRÜNÜN KALİTE ALGISINA VE İŞLETME PERFORMANSINA ETKİSİ." *Atatürk Üniversitesi İktisadi ve İdari Bilimler Dergisi* 19.1 (2005).
- [9]. Güleş, H. K., & Bülbül, H. (2004). *Yenilikçilik: İşletmeler İçin Stratejik Üstünlük*, Nobel Yayınları
- [10]. Güleş, H., K. ve Bülbül, H. (2004). *Toplam Kalite Yönetiminin İşletmelerde Yenilik Çalışmalarına Katkıları*, Gazi Üniversitesi, İ.İ.B.F. Dergisi, 115-129.
- [11]. Hezlett, S. A., & Gibson, S. K. (2007). Linking mentoring and social capital: Implications for career and organization development. *Advances in Developing Human Resources*, 9(3), 384-411.
- [12]. Karagül M ve Dündar S (2006). Sosyal Sermaye Ve Belirleyicileri Üzerine Ampirik Bir Çalışma, *Akdeniz İ.İ.B.F. Dergisi* (12) 2006, 61-78
- [13]. Karagül, M. Masca, M. (2005). Sosyal Sermaye Üzerine Bir İnceleme, *Ekonomik ve Sosyal Araştırmalar Dergisi*, 1, 37-52.
- [14]. Onyx, J., ve Bullen, P., 2000, *Measuring Social Capital in Five Communities*, *Journal of Applied Behavioral Science*, 36(1): 23-42.
- [15]. Osterloh, M. ve B. S. Frey (2000), "Motivation, Knowledge Transfer, and Organizational Forms," *Organization Science*, 11(5): 538-550.
- [16]. ROTHE F., SCHÜLER D. (2006) *Trust and Economic Growth: A Panel Analysis*, Ratio Working Papers 102.
- [17]. SCOTT, S. G., ve Bruce, R. A. (1994), "Determinants of Innovative Behavior: A Path Model of Individual Innovation in The Workplace", *Academy of Management Journal*, 37(3), p. 580-607
- [18]. Turgut, E. ve Begenirbaş, M. (2013). Çalışanların Yenilikçi Davranışları Üzerinde Sosyal Sermaye ve Yenilikçi İklimin Rolü: Sağlık Sektöründe Bir Araştırma, *KHO Bilim Dergisi*, 23 (2).
- [19]. Turgut, E. ve Begenirbaş, M. (2014). İlişkisel Sosyal Sermayenin Yenilikçi Davranışa Etkisinde Örtülü Bilgi Paylaşımı Davranışının Aracılık Rolü, *Niğde Üniversitesi, İ.İ.B.F. Dergisi*, 7 (1), 146-160.
- [20]. Turgut, E., & BEGENİRBAŞ, M. (2014). İlişkisel sosyal sermayenin yenilikçi davranışa etkisinde örtülü bilgi paylaşımı davranışının aracılık rolü. *Niğde Üniversitesi İktisadi ve İdari Bilimler Fakültesi Dergisi*, 7(1), 146.
- [21]. WOODHAUSE, Andrev. (2006) *Social Capital and Regional Development in Australia: A Case Study*, *Journal of Rural Studies*, No. 22, ss. 83-94.
- [22]. Zaltman, J., Duncan, R. & Holbeck, J. (1973). *Innovations and Organizations*. New York: John Wiley and Sons.

# The Effect Of The Psychological Contract Perception And Its Breach On The Organizational Commitment: A Research In A Company Operating In The Manufacturing Sector

Nezahat Kocyigit<sup>1</sup>, E. Nihan Cici Karaboga<sup>1</sup> A.Elif Yazgan<sup>1</sup>

---

## Abstract

Globalization, rapid changes and developments occurring in the information and communication technology are changing the businesses and employees' covered and mutual expectations and responsibilities. Organizational structure which decreases with the increasing of information system using, increasing layoffs, changing of the employment relationship, beginning of the developing modern business relationship have increasingly become important the psychological contract from the aspect of the disappointed employers and employees. While psychological contract's items are usually honesty, commitment to the organization, doing qualified work, higher performance task and so on in terms of the business, they are increasing the responsibilities, promotion, opportunities to improve their skills, open communication, social rights and so on in terms of the employees. There are some predictions that written business contracts will be affected and organizational commitment, productivity and motivation will reduce in case of breaching the unwritten psychological contract. Therefore organizations need to retain the employees who devote their selves to the organization, create forces unity by doing aims and objectives unity with the organization and are motivated for both continuation of the written business contract and the organization's success and competitiveness.

In this study researching of the psychological contract perception and the effects of it on the organizational commitment in case of its breaching has been aimed. The data collected by a questionnaire on the employees in a company operating in manufacturing sector will be analyzed and recommendations for businesses and the sector will be made.

**Keywords:** Psychological contract, psychological contract breaching, organizational commitment.

---

## 1. INTRODUCTION

By being knowledge and human of the most important source for managements at competitive, to try to make employees who had high level obedience to the organizations and who were more productive and fertile became important. Employment security based on performance threatens the idea of the lifelong employment security. The managements want to keep the employees who give much more than expected, accommodate, have high work satisfaction and citizenship behavior inside the organization and take management ability more than personel management.

Psychological contract concept being results such as motivation, organizational justice, organizational devotion, work satisfaction, peaceful work environment come into prominence as well as organizational culture, organizational climate etc. premises which contain mutual expectations and liabilities of parties in employment relationship. If not so, perception intended infringement of contract brings about increasing of leaving intention from the work in organization, breaking down the peace of work, decreasing the sense of belonging, rising of results such as the anger and cynicism etc.

In this study, searching of the efficiencies being to organizational devotion of infringement and psychological abstract was done. Because of being new of the concepts, it is aimed at to fill in the blanks in literature, to provide awareness related to subject, to increase devotion and dependence to organization, to take away differences in perception of the violations, expectations and liabilities between the parties.

## 1. CONCEPTUAL FRAMEWORK

### 1.1. Psychological Contract Concept

The first usage of concept is based on Argyris's [2] study. Schein's (1978), Levinson's, Price's, Munden's and Solley's studies [10] are in between the other studies which contribute in development of psychological contract [4]. Although psychological contract comes in the literature in 1960's, Social Exchange, Equality, Expectation, Reciprocity Theory and the model of Lawler Porter are the helper theories in understanding the concept [4].

Psychological contract concept first appeared in the book named "Understanding of Organizational Behavior" which Argyris published in 1960. Argyris qualified the organization as complicated and alive structure, put forward that the organizations and individual were in perpetual interaction with each other and connected to existing of psychological contract which will be

---

<sup>1</sup>Corresponding author: Necmettin Erbakan University, Academy Of Applied Sciences, Abdülaziz Mh. Abdülmümin Sk., No: 16, Meram/Konya, Turkey. nkocyigit@konya.edu., trenihancici@konya.edu.tr, aelifyazgan@konya.edu.tr

developed together with their employees of the management effects [6]. According to Argyris [2], psychological contracts are the contracts being nuncupative and unreceptive intended having respect for each other's norms between the employee and employer. According to Schein (1980). Psychological contracts are "the expectations sequence being nuncupative between employee and institution." Levinson et al (1962) expressed in case "psychological contract is total of expectations being between the employee and institution" [4].

Some of the definitions known very well also started to be given by contrasting to the question "What is the psychological contract?"

\*It is a covered contract indicating to expect all what they take and all what they give from their relationships between the employee and institution (Kotter, 1973), perceptions of parties about liabilities implied in employment relation (Herriot and Pemberton), [8].

\*Psychological contracts are beliefs of the employee related to mutual liability between employee and organization. In other words, these beliefs become a nuncupative contract of their perceptions related to be in debt himself some encouragements such as labor safety, high pay of employer in return of contributions working hard and keeping to organization etc. [17].

Psychological contract involving the expectations and liabilities perceived is a dynamic concept involving the expectations which he thinks of being promised himself towards that he will be rewarded depending on performance he puts forward [1].

By increasing the attention for psychological contract in 1990's, Lucera, Robinson, Rousseau and Morrison mentioned different and value two characters related to concepts [6].

\*Psychological contracts are the beliefs being liabilities in their employment relationship.

\*Psychological contracts are commitments perceived, that is, it is a kind of communication for future aims.

Indeed having not acquaintance with this subject it can be estimated that mentioning of some expectations will not be nice with the effect of cultural norms and will feel the disappointment anxiety etc. amongst the reasons of being not written and being not expressed openly [4].

Psychological contracts generally contains two dimensions as operative and relationally. Operative contracts contain certain cash changes (e.g. payoff for attendance to work) between the parties buying-oriented firms in case of perpetual and temporary employment. These kinds of contracts contain acquisition of employees having private skills in order to supply the available needs (e.g. advanced technology firms, temporary employment bureau etc.). Wages rates extremely competitive, not being of long-term commitment and not being of flexibility are the characteristic of operative contracts [17]. Keeping secret the organization information of employee, informing the employer before quitting from work, promoting the employee of organization as well, etc. are available expectations in operative contracts.

Relationally contracts are open ended contracts that affective commitment carries weight, that there are moral expectations such as employment security and career and that is based on social exchange on the contrary saving money or not saving money, including both of them, in being maintained of a relation (e.g. heavy duties, fidelity, security etc.). These kinds of arrangements are generally found in the organizations (e.g. service businesses)-oriented to being developed to supply their needs in future and at the beginning level in employing of the individuals [17]. Rousseau's first studies with this study are found that expectations flow away the liabilities and focusing from the relation level to individual level [5].

In brief, a psychological contract is a change relation between both sides (employee and employer). This relation which will be able to express such as organizational social change contains liabilities binding both sides is faith-based and sense towards which will be response of pure-minded activities of one-side [18].

## 1.2. Infringement of Psychological Contract.

Infringement occurs when perceiving that one-side doesn't carry out the promises in a relation. But the infringement of psychological contract is different from expectation and inequality perceptions unfulfilled. The employees are able to enter the unrealistic expectations at the beginning and when being receiving these expectations, they are glad little, they are able to put forward lower performance and the opportunities abdication the institution are increasing. But in case of psychological contract infringement, violence of reaction can be much harder. For example, an employee is able to disappointed wages in return for his dense and hard work when not paid of overcharged which he waits for payable and by thinking hard done by, he is able to show anger and temper symptoms [16].

Infringement of psychological contract is perception concerning that person fall through in fulfilling of organization one or much more liabilities in psychological contract. This definition demonstrates that the infringement is an intellectual and cognitive calculation concerning what is bought depending on those promised by one by [13].

Process of infringement which the two factors such as dissonance and not keeping their promises play role is a process being distributionally, relationally and procedurally dimensions. So that, not keeping the promises is not fulfilling those promised to the employees of organization. In this situation, it is found that the employee looks at what he obtains in return those promised to himself and contrasts with those promised and with those given, if the content is small across those promised, it is becoming of violated perception of contract by employee. Nevertheless, it is found that employee and organization infer differently concerning commitments given in dissonance [6].

### 1.3. Organizational Devotion

Organizational devotion is acquisition of knowledge process for the aims and targets of organization, due to psychological contract, becoming a member of organization of the employees. In this sense, organizational devotion is union force that individuals forms by entering into the union of target and aim. Along with the organizational devotion displays alterations according to circumstances, there are several indicators which designates the devotion. These indicators are adoption of organization's aims and worths, presentation of unselfish behaviors intra organization, desire of a strong feel towards continuing to organization, associate with organization, internalization of rules and principles of organization [7].

## 2. METHODOLOGY AND DEMOGRAPHIC RESULTS

### 2.1. Method of Search and The Used Scalas

The search forms employees of a company operating in the manufacturing sector in Konya province. Since the purpose of our search is to express the relations causals between the variables treated, the participants meet this expectation. The questionnaire method will be used as a data collection method.

The method of questionnaire was used as data collecting tool in study and its respective form was prepared as 4 sections. In the first section, questions related to demographic features formed from 7 items.

In the second section, the scala of psychological contract appears in used by several researchers such as Özgen and Özgen [14], Yılmaz [19] and Cihangiroğlu and Şahin [4], adopted by Mimaroglu [12] to Turkish and improved by Millward and Hopkins [11]. The scala is formed from 17 items and it is related to 10 items of it from operative sub-dimension of psychological contract, 7 items of it from relationally sub-dimension. With the order to determine the participation levels of answerers to questions on the way "1: I don't certainly join, 2: I don't join, 3: neither agree nor disagree, 4: I join, 5: I join completely, 6: I join partly was expressed as quinary Likert Scala.

In the third section, in the measurement of psychological contract infringement the scala for one question was used assesment score with Likert Scala appeared in Yılmaz' [19] study and improved by Robinson and Rousseau [16]. To determine the participation level in the infringement scala, quinary Likert Scals was used such as 1: it is being received completely, 2: it is being received most of it, 3: it is being received some, 4: it is being received partly, 5: it is never being received.

In the last section of form, model of 18 items organizational devotion used by Kutluay [9], translated into Turkish by Baş, improved by Rich Repine and Crawford [15] appeared in. With the order to determine the participation level of answerers to questions on the way "1: I don't certainly join, 2: I don't join, 3: neither agree nor disagree, 4: I join, 5: I join completely" was expressed as quinary Likert Scala.

In this study researching of the psychological contract perception and the effects of it on the organizational commitment in case of its breaching has been aimed.

This study was applied to the employees in a company operating in manufacturing sector active in Konya province. Generally there are total 60 executive personals in company. It was reached to 36 executive personals with in the research. This shows that approximately percent 36 personal are reached. It can be said that this rate is generally representing ability the main group.

Table 1. Demographic Features

Demographic Features		Count	percentage (%)
Sex	Female	5	13,89
	Male	31	86,11
	Total	36	100
Age	20 age and under	1	2,78
	21-30 age	16	44,4
	31-40 age	14	38,89
	41-50 age	4	11,11
	50 age and over	1	2,78
	Total	36	100
Marital Status	Married	20	57,14
	Single	15	42,86
	Total	36	100
Education Status	Primary education	1	2,78
	High school	13	36,11
	Undergraduate degree	16	44,44
	Postgraduate	6	16,67
	Total	36	100
Period of Service in the sector	0-5 year	10	28,57
	6-10 year	10	28,57
	11-15 year	10	28,57
	16-20 year	1	2,86
	21 year and over	4	11,43
	Total	30	100
Period of Service in this company	0-5 year	19	54,29
	6-10 year	9	25,71
	11-15 year	4	11,43
	16-20 year	2	5,71
	21 year and over	1	2,86
	Total	35	100
Operation Time in a day	0-4 hour	3	8,82
	0-8 hour	14	41,18
	0-10 hour	17	50,00
	Total	34	100

According to the Table 1 it has been seen that participants are generally at 21-30 age range, men, mostly undergraduate degree, the seniority period in the business is 0-5 year range, married (57.1%) and the operation time in a day is 0-10 hour range.

## 2.2. The Significance Level Of Psychological Contract Perception and Its Breach, The Organizational Commitment Dimensions

In this part, it was measured by Friedman Test the severity ratings between the participation levels of the answerer to the statements at the Likert scaled dimension.



Table 2. The Psychological Contract Perception Scale Importance Ranking

<b>The Psychological Contract Perception Scala Importance Ranking</b>		
	Mean	Std Deviation
I do this job just for the money	2,55	1,175
I prefer to work a strictly defined set of working hours.	2,45	1,252
It is important not to get too involved in your job.	2,79	1,244
I expect to be paid for any overtime I do.	3,16	1,344
I come to work purely to get the job done.	2,65	1,305
My loyalty to the organization is contract specific.	2,27	1,180
I only carry out what is necessary to get the job done.	2,16	,987
I work to achieve the purely short-term goals of my job.	2,03	1,031
I will work for this company indefinitely.	2,97	1,204
I am heavily involved in my place of work.	3,18	1,402
I expect to gain promotion in this company with length of service	3,63	1,314
I expect to grow in this organization.	3,41	1,542
I feel part of a team in this organization.	3,70	1,237
The organization develops/rewards employees who work hard and exert themselves.	3,06	1,413
I am motivated to contribute 100% to this company in return for future employment benefits	3,58	1,347
I have a reasonable chance of promotion if I work hard.	3,38	1,497
My career path in the organization is clearly mapped out.	3,29	1,321

Table 3. The Psychological Contract Violation Scale Importance Ranking

<b>The Psychological Contract Violation Scala Importance Ranking</b>		
	Mean	Std. Deviation
What are you thinking of that your employer generally fulfilled the promised obligations that they owed you?	2,28	1,92

Table 4. Organizational Commitment Scale Importance Ranking

The Organizational Commitment Scale Importance Ranking		
	Mean	Std Deviation
I work with intensity on my job	3,67	1,315
I exert my full effort to my job	3,54	1,453
I devote a lot of energy to my job	3,58	1,259
I try my hardest to perform well on my job	3,77	1,194
I strive as hard as I can to complete my job	3,50	1,459
I exert a lot of energy on my job	3,79	1,111
I am enthusiastic in my job	3,53	1,367
I feel energetic at my job	3,39	1,223
I am interested in my job	3,67	1,339
I am proud of my job	3,64	1,270
I feel positive about my job	3,64	1,245
I am excited about my job.	3,75	1,164
At work, my mind is focused on my job	3,67	1,109
At work, I pay a lot of attention to my job	3,97	1,159
At work, I focus a great deal of attention on my job .	3,70	1,237
At work, I am absorbed by my job .	3,24	1,226
At work, I concentrate on my job .	3,45	1,227
At work, I devote a lot of attention to my job .	3,58	1,226

## 2.2. The Model of Research, The Analysis of Correlation and Regressions

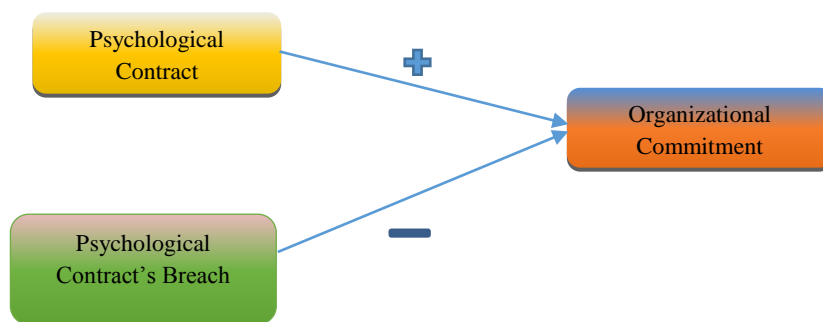

Figure 1. Search Model

Core Hypothesis:

H1: has an effect on the organizational devotion of psychological contracts of employees.

H2: has an effect as negatively on organizational devotion of infringement of psychological contracts.

## 2.3. Findings

The surveys were analyzed in SPSS programme. (mean, standart deviation, simple linear regression and  $p < 0,05$ ).

### Model Summary

Model	R	R Square	Adjusted R Square	Std. Error of the Estimate
1	,722 <sup>a</sup>	,521	,505	,70191

a. Predictors: (Constant), psychological contrast, organizational commitment

H1: has an effect on the organizational devotion of psychological contracts of employees (Accept)

### ANOVA<sup>a</sup>

Model		Sum of Squares	df	Mean Square	F	Sig.
1	Regression	16,594	1	16,594	33,681	,000 <sup>b</sup>
	Residual	15,273	31	,493		
	Total	31,866	32			

a. Dependent Variable: organizational commitment

b. Predictors: (Constant), psychological contrast, organizational commitment

### Coefficients<sup>a</sup>

Model		Unstandardized Coefficients		Standardized Coefficients	t	Sig.
		B	Std. Error	Beta		
1	(Constant)	,707	,514		1,374	,179
	ort_p	,981	,169	,722	5,804	,000

a. Dependent Variable: organizational commitments

### Model Summary 2.

	R	R Square	Adjusted R Square	Std. Error of the Estimate
	,016 <sup>a</sup>	,000	-,037	1,01039

a. Predictors: (Constant), psychological contrast violent

### ANOVA<sup>a</sup>

Model		Sum of Squares	df	Mean Square	F	Sig.
1	Regression	,007	1	,007	,007	,935 <sup>b</sup>
	Residual	27,564	27	1,021		
	Total	27,571	28			

a. Dependent Variable: organizational commitment

b. Predictors: (Constant), psychological contrast violent

### Coefficients<sup>a</sup>

Model		Unstandardized Coefficients		Standardized Coefficients	t	Sig.
		B	Std. Error	Beta		
1	(Constant)	3,622	,410		8,834	,000
	S9	,013	,160	,016	,083	,935

a. Dependent Variable: organizational commitment

H2: has an effect as negatively on organizational devotion of infringement of psychological contracts (There is no significant relationship statistically and model summary is not meaningful)

### 3. CONCLUSION

Psychological contracts being important results between employee and his institution shape the employee's behavior, and also persuade on each sides that they are in debt each other and recruit the relation intermediary. By this means, organization that the roles become harmony, which dispatches human resource into volunteer effort for institution, shadows out the worth given to employee, strengthens its employee about improving of their abilities and skills will clearly precede in catching the competitive and success. The employees who work such organization will performance over duty and will increase dependences and devotions.

The main purpose of this study is to analyze the efficient on organizational commitment of executive employees related to psychological contract and psychological contract violation. This efficient was measured with the simple linear regression analysis. According to this, it was established that existence of a positive relation between organizational commitment and psychological contract. Also, it was established that existence of a negative relation between organizational commitment and psychological contract violation.

### REFERENCES

- [1] Y. N. Akar, "Psikolojik Sözleşme İhlalleri Bağlamında Örgütsel Sinizm Üzerine Bir Kuramsal Araştırma", 1. Turizmde İnsan Kaynakları Gelişimi Sempozyumu Bildiri Kitabı, 2010, 43-60.
- [2] C. Argyris, "Understanding Organizational Behavior", 3. Baskı, Dorsey Pres: Homewood, Illinois, 1960.
- [3] T. Baş, "Çalışanların Tatmin ve Adanmışlık (Engagement) Düzeyleri Nasıl Ölçülmeli?", <http://www.yeniik.com/post/7800966247/calisanlarin-tatmin-ve-adanmislik-engagement>, 2011.
- [4] N. Cihangiroğlu and B.Şahin, "Organizasyonlarda Önemli Bir Fenomen: Psikolojik Sözleşme", ZKÜ Sosyal Bilimler Dergisi, C. 6, (11), 1-16, 2010.
- [5] J. Coyle-Shapiro and I. Kessler, "Consequences of the Psychological Contract for the Employment Relationship: A Large-Scale Survey", Journal of Management Studies, Vol. 37, 903-930, 2000.
- [6] S. Doğan and Demiral, Ö, "Örgütsel Bağlılığın Sağlanmasında Personel Güçlendirme ve Psikolojik Sözleşmesinin Etkisine İlişkin Bir Araştırma", Erciyes Üniversitesi İktisadi ve İdari Bilimler Fakültesi Dergisi, 32, 47-80, 2009.
- [7] E. G. Gümüştekin, D. E. Özler and F. Yılmaz, "360 Derece Performans Değerleme Sisteminin Örgütsel Bağlılık Üzerindeki Etkisinin Belirlenmesine Yönelik Bir Araştırma", Business and Economics Research Journal, 1,(1), 1-2010.
- [8] D. E. Guest, "Is the Psychological Contract Worth Taking Seriously?", Journal of Organizational Behavior, 19, 649-654, 1998.
- [9] Y. Kutluay, "Araştırma Görevlilerinin Örgütsel Adanmışlık ve Öz- Yeterliliklerinin Örgütsel Sessizlikleri Üzerine Etkisi," Yüksek Lisans Tezi, Süleyman Demirel Üniversitesi Sosyal Bilimler Enstitüsü, Isparta, 2012.
- [10] H. Levinson, C.R. Price, K.J. Munden and C.M. Solley, "Men, Management and Mental Health", Harvard University Pres: Cambridge, 1962.
- [11] L. J. Millward and L. J. Hopkins, "Psychological Contracts, Organizational and Job Commitment", Journal of Applied Social Psychology, 28(16), 1530-1556, 1998.
- [12] H. Mimaroğlu, "Psikolojik Sözleşme Ve Boyutlarının İş Tatmini, Örgütsel Bağlılık Ve İşten Ayrılma Niyetine Etkileri: Tıbbi Satış Temsilcileri Üzerinde Bir Araştırma", Doktora Tezi, Çukurova Üniversitesi Sosyal Bilimler Enstitüsü, Adana, 2008.
- [13] E. W. Morrison and S. L. Robinson, "When Employees Feel Betrayed: A Model of How Psychological Contract Violation Develops", Academy of Management Review, 22(1), 226-256, 1997.
- [14] M. H. Özgen and H. Özgen, "Psikolojik Sözleşme ve Boyutlarının İş Tatmini, Örgütsel Bağlılık ve İşten Ayrılma Niyetine Etkileri: Tıbbi Satış Temsilcileri Üzerinde Bir Araştırma", Ç.Ü. Sosyal Bilimler Enstitüsü Dergisi, 19(1), 1-19, 2010.
- [15] B. L. Rich and E. R. and Crawford, "Job Engagement: Antecedents and Effects on Job Performance", The Academy of Management Journal (AMJ), 53, (3), 617-635, 2010.
- [16] S.L. Robinson and D.M. Rousseau, "Violating the Psychological Contract: Not The Exception But The Norm", Journal of Organizational Behavior, 15, 245-259, 1994.
- [17] D.M. Rousseau, "New Hire Perceptions of Their Own and Their Employer's obligations: A Study of Psychological Contracts," Journal of Organizational Behavior, 11, 389-400, 1990.
- [18] A. Walker and D. M. Hutton, "The Application of the Psychological Contract to Workplace Safety", Journal of Safety Research, 37(5), 433-441, 2006.
- [19] A. Yılmaz, "Psikolojik Sözleşme ve Örgütsel Güven Arasındaki İlişkinin Analizi: Teorik ve Uygulamalı Bir Çalışma", Yüksek Lisans Tezi, Selçuk Üniversitesi Sosyal Bilimler Enstitüsü, Konya, 2012.

# Spatial distribution of mean wave energy flux over the Black Sea

*Adem Akpınar<sup>1</sup>, Bilal Bingolbali<sup>2</sup>, Halid Jafali<sup>3</sup>*

---

## Abstract

*The aim of this study is to determine spatial distributions of annual, seasonal, and monthly mean wave energy flux over the Black Sea. For this, the wave characteristics are obtained in half-hour temporal resolution produced with a calibrated SWAN model [1, 2] during 31 years. Spatial distribution of wave energy flux is determined by using spatial distributions of significant wave height and energy period over the Black Sea. The results show maximum value of the average wave energy flux over the Black sea during 31 years is 5.72 kW / m. Bulgaria's coasts and the coasts of Istanbul, Sakarya and Kırklareli in Turkey have the highest wave energy (about 5 kW / m). This is probably due to strong eastern and north-eastern winds and their long fetch lengths. Average wave power generated based on all years of the spatial distribution over the Black Sea is very similar to the seasonal average wave power but their values are different. In each season, the average wave power reaches highest values off the coast of south-western Black Sea, while it decreases towards the north-west and east. It continues to decline towards the south. In all seasons, just like all annual average wave power map, the lowest value areas are found along the Georgian coast of Batumi.*

**Keywords:** *wave energy; spatial distribution; SWAN; Black Sea*

---

## 1. INTRODUCTION

Wave energy is abundant and the amount of energy that can be created using wave technologies varies from site-to-site and from day-to-day, depending on location and weather conditions. Nevertheless, wave energy can be accurately predicted using numerical models. The potential for the wave energy extraction can be obtained from analysis of the wave climate. Buoy data can give a general idea of the existing conditions as well as valuable information concerning some tendencies. Nevertheless, this approach has some limitations especially due to the facts that the time period of the measurement is in general limited and they are usually operating in deep water. It is thus of major interest to develop a system that is able to predict the wave characteristics in various coastal locations, not necessarily considered as deep water. That is why it is essential to predict the wave conditions with numerical models [3].

We have recently performed a hindcast study of 31 years, which includes all of the Black Sea coasts, using a calibrated third-generation wave model (SWAN) in the context of the TUBITAK project [1] "Temporal and Spatial Analysis of Wave Energy Potential during South-western coasts of the Black Sea". The present work aims to assess the spatial distribution patterns of the wave energy in the Black Sea basin using this wind and wave database. The predictions of averaged annual, seasonal, and monthly wave power will be here shown. The most hot spot areas in the Black Sea basin will be thus better identified from an energetic point of view.

## 2. MODEL SETUP

For computation of spatial distribution of wave power in the Black Sea, the generation and propagation of wind waves have been modelled using the third-generation wave model SWAN cycle III version 41.01 [4, 5]. SWAN model forced with the CFSR wind fields has been applied in the Black Sea to obtain 31-year wave characteristics and perform an assessment of spatial distributions of wave power. The SWAN cycle III version 41.01 model was run in third generation and non-stationary mode. The time step is set to 15 minutes and one iteration per time step was used according to Akpınar et al. [6] who found it to be sufficient. The entire Black Sea was chosen as the model's domain (shown in Figure 1). It lies between 27°E and 42°E longitude and 40°N and 48°N latitude. A 225 x 120 regular grid in spherical coordinates covers the whole Black Sea, including Azov Sea, with a uniform resolution of 0.067 degrees (1/15°) in each direction, corresponding to about 7.7 km of latitude and about 5.43 km of longitude. The directional wave energy density spectrum function was discretized using 36 directional bins and 35 frequency bins geometrically spaced from 0.04 Hz to 1.0 Hz. The slightly dispersive BSBT (first order upwind; backward space, backward time) scheme was used as the numerical scheme. Akpınar et al. [6] presents details regarding the numerical settings of the SWAN model in the Black Sea.

---

<sup>1</sup>Corresponding author: Uludağ University, Department of Civil Engineering, 16059, Nilüfer/Bursa, Turkey. [ademakpinar@uludag.edu.tr](mailto:ademakpinar@uludag.edu.tr)

<sup>2</sup>Uludağ University, Department of Civil Engineering, 16059, Nilüfer/Bursa, Turkey. [arda\\_bilal\\_49@hotmail.com](mailto:arda_bilal_49@hotmail.com)

<sup>3</sup>Uludağ University, Department of Civil Engineering, 16059, Nilüfer/Bursa, Turkey. [halidjfone@gmail.com](mailto:halidjfone@gmail.com)

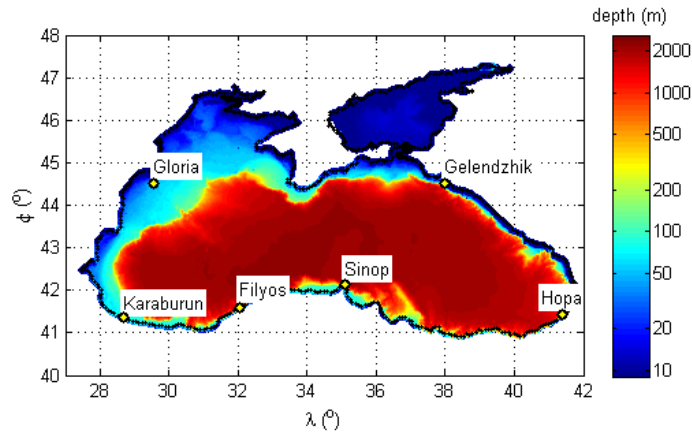

Figure 13. The model domain, the bathymetry of the Black Sea, and wave measurement locations

The setting for wave model computations is based on the calibrated SWAN model in Akpınar et al. [1, 2]. Wave growth by wind is evaluated with the formulation of Komen et al. [7]. For wave energy dissipation by whitecapping, the adaptations of Janssen's [8, 9] model are used, in which  $\Delta = 1$  according to Rogers et al. [10] and whitecapping dissipation coefficient ( $C_{ds} = 1.5$  according to Akpınar et al. [1, 2] for the SWAN model forced with the CFSR winds in the Black Sea. Discrete Interaction Approximation (DIA) by Hasselmann et al. [11] is used for the computation of nonlinear quadruplet interactions where  $\lambda$  and  $C_{nl4}$  values are set to 0.25 and  $3 \times 10^7$ , respectively. Energy dissipation due to bottom friction is evaluated using the JONSWAP parameterization with the constant value of bottom-friction coefficient ( $C_{fjon} = 0.038 \text{ m}^2 \text{ s}^{-3}$ ) suggested by Zijlema et al. [12]. Energy dissipation by depth-limited wave breaking is modelled according to the bore-model of Battjes and Janssen [13] where  $\alpha$  and  $\gamma$  values are set to 1 and 0.73, respectively. Triad wave-wave interactions are also activated and computed using the Lumped Triad Approximation (LTA) by Eldeberky [14] in the model.

The wave model is driven by CFSR wind velocity components [15] of the National Centers for Environmental Prediction (NCEP). These components are at 10 m above the free surface, at a time step of 1 h and a spatial resolution of  $0.3125^\circ$ . Also, bathymetric data, which is shown in Figure 1 as a contour map, was obtained from GEBCO [16], General Bathymetric Charts of the Ocean, produced by the British Oceanographic Data Centre (BODC). Its resolution is 30 arc-seconds in both latitude and longitude. The integrated parameters such as  $H_{m0}$ , mean energy period  $T_{m-10}$ , and mean wave direction (DIR) etc. have been recorded half-hourly in all points of the computation grid over a 31-year period. An extensive evaluation of the calibration and validation of the SWAN wave hindcast model has been carried out in Akpınar et al. [1, 2].

### 3. RESULTS AND DISCUSSION

Instantaneous wave energy flux was computed based on integral parameters  $H_{m0}$  and  $T_{m-10}$  using the formulae below:

$$P_w = 0.486 \times H_{m0}^2 \times T_{m-10} \quad (1)$$

Averaged annual wave energy flux was determined using instantaneous wave energy fluxes computed from the integral parameters simulated in half-hour temporal resolution during 31 years. Its spatial distribution is given in Figure 2. According to the figure, the maximum value of average wave energy flux over the Black Sea is 5.7 kW/m. Bulgaria's coast and the coasts of Istanbul, Sakarya and Kırklareli in Turkey have the highest wave energy (about 5 kW/m). This is probably due to strong eastern and north-eastern winds and their long fetch lengths. Romania's Constanta coast and Turkey's coasts from Sinop to Sakarya are wave energy potential areas considered to be of secondary importance [17].

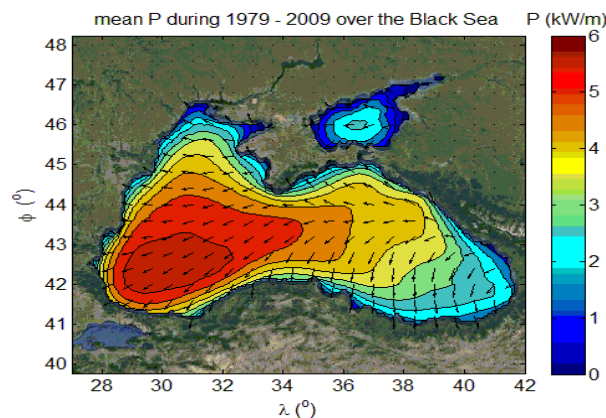

Figure 2. Averaged mean wave energy flux predicted by the SWAN model over the period 1979 – 2009 in the Black Sea [17]

To get more insight on the temporal variability, an approach by presenting seasonal and monthly mean wave energy flux per unit crest is given in Figures 3 and 4.

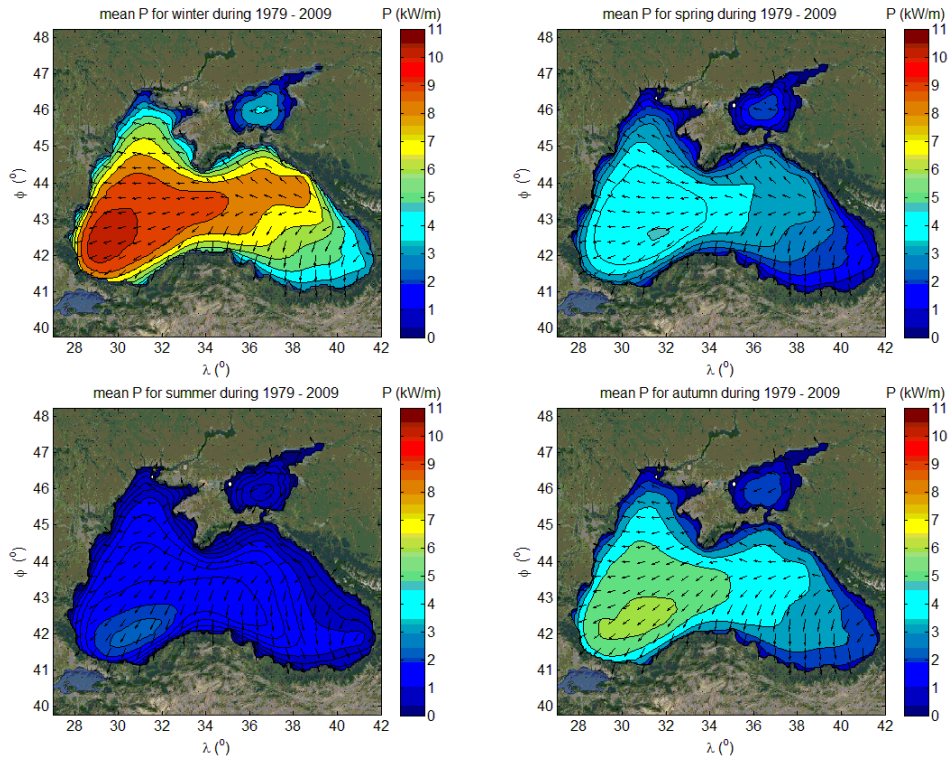
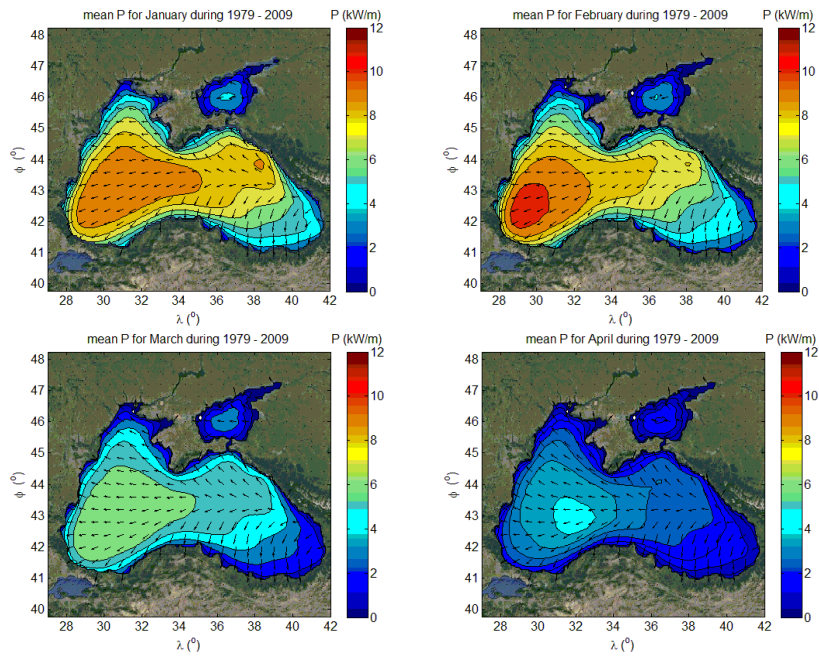

Figure 3. Seasonal mean wave energy flux for the 1979 - 2009 period. Winter: Dec-Jan-Feb and Spring: Mar-Apr-May in upper panel; Summer: Jun-Jul-Aug and Autumn: Sep-Oct-Nov in bottom panel [17]



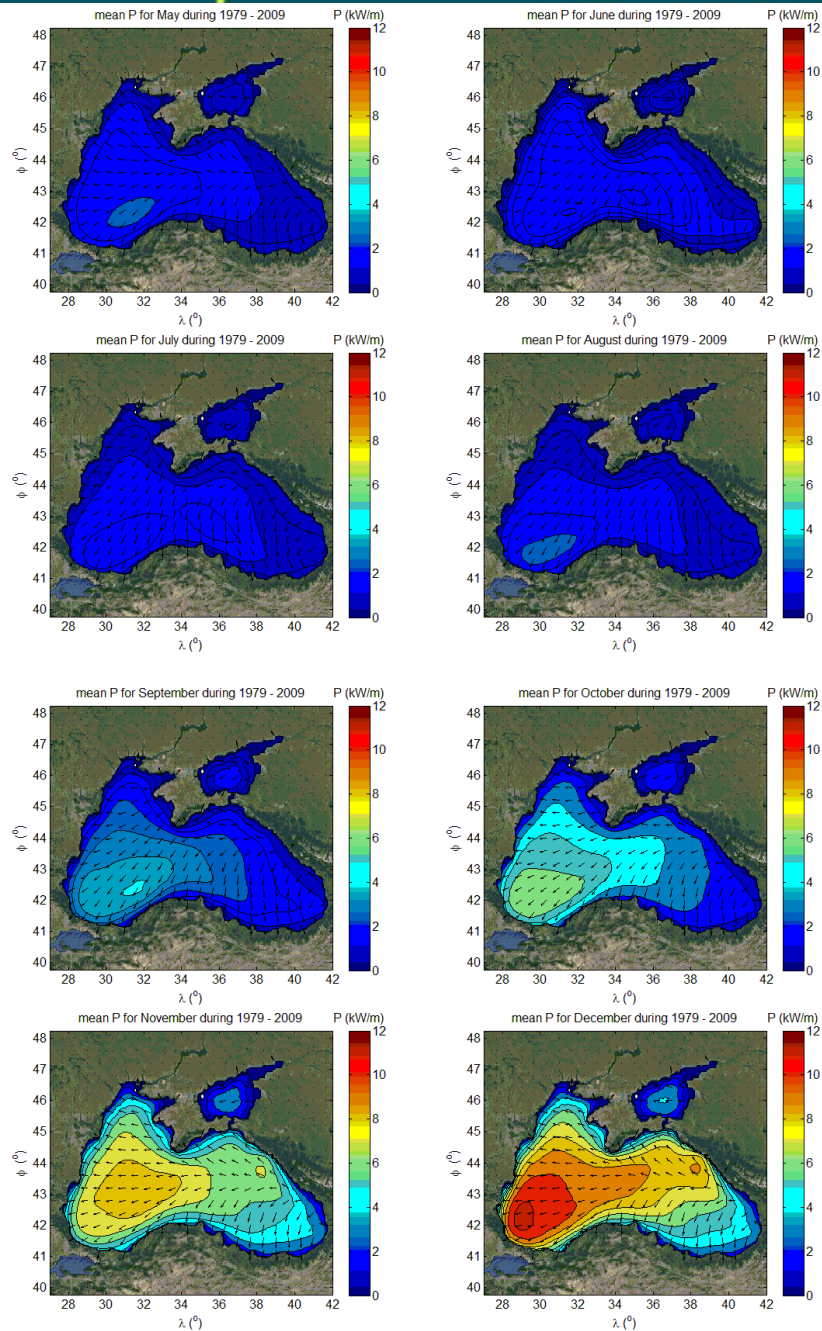

Figure 4. Monthly mean wave energy flux for the 1979 - 2009 period [17]

When these graphs are analyzed, the average wave power (in Figure 2) generated based on all years of the spatial distribution over the Black Sea is very similar to the seasonal average wave power (Figure 3) but their values are different. In each season, the average wave power reaches their highest values off the coast of the south-western Black Sea, while it decreases toward the north-west and east. It continues to decline towards the South. In all seasons, just like all annual average wave power maps, the lowest value areas are found along the Georgian coast of Batumi. The months of December, January and February which fall in winter, have the largest contribution to the annual average wave power potential with a maximum of up to 10.5 kW/m. Winter is followed by autumn that covers September, October and November with a maximum of 6.3 kW/m. Followed by the autumn season is spring in the months of March, April and May with a maximum value of 4.5 kW/m and lastly with a maximum value of 2.3 kW/m, the summer season follows. As seen, there is quite a big difference between the highest average wave energy value in summer and that of winter in the Black Sea. This indicates how much the potential wave power is sensitive to seasonal variations. Monthly average wave power maps are presented in Figure 4 for the period from 1979 to 2009. This figure shows that for the period from April to September, the average wave energy is less than 4 kW/m. Winter months have the highest wave energy flux. With 11.3 kW/m, December is the most energetic month while June in summer has the lowest value of 1.8 kW/m [17].



## 4. CONCLUSION

This study quantifies spatial distributions of annual, seasonal, and monthly averaged wave energy flux. Maximum value of the average wave energy flux over the Black sea during 31 years was determined as 5.72 kW / m. Bulgaria's coasts and the coasts of Istanbul, Sakarya and Kırklareli in Turkey had the highest wave energy (about 5 kW / m). This is probably due to strong eastern and north-eastern winds and their long fetch lengths. Average wave power generated based on all years of the spatial distribution over the Black Sea was very similar to the seasonal average wave power but their values were different. In each season, the average wave power reached highest values off the coast of south-western Black Sea, while it decreased towards the north-west and east. It continued to decline towards the south. In all seasons, just like all annual average wave power map, the lowest value areas were found along the Georgian coast of Batumi.

For the future works, wave energy potential of hot spot areas will be investigated in detail using a nested grid wave hindcast system.

## ACKNOWLEDGMENT

Special thanks from the author go to TUBITAK (The Scientific and Technological Research Council of Turkey) for its supporting our Project under the grant number 214M436.

## REFERENCES

- [1] A. Akpınar, S. Bekiroğlu, G.Ph. Van Vledder, B. Bingölbali, H. Jafari, "Temporal and spatial analysis of wave energy potential during south western coasts of the Black Sea". TUBITAK Project No. 214M436. 2015
- [2] A. Akpınar, B. Bingölbali, and G.Ph. Van Vledder, "Wind and wave characteristics in the Black Sea based on the SWAN model forcing with the CFSR winds". *Ocean Engineering*, vol. 126, pp. 276 - 298. 2016
- [3] E. Rusu, C. Guedes Soares, "Numerical modelling to estimate the spatial distribution of the wave energy in the Portuguese nearshore", *Renewable Energy*, vol. 34, pp. 1501 – 1516. 2009.
- [4] N. Booij, L.H. Holthuijsen, R.C. Ris, "A third-generation wave model for coastal regions. 1: model description and validation". *Journal of Geophysical Research*, vol. 104 (C4), pp. 7649 - 7666. 1999.
- [5] R.C. Ris, L.H. Holthuijsen, N. Booij, "A third-generation wave model for coastal regions: 2. Verification". *Journal of Geophysical Research*, vol. 104 (C4), pp. 7667 - 7681. 1999.
- [6] A. Akpınar, G.Ph. Van vledder, M.İ. Kömürçü, M. Özger, "Evaluation of the numerical wave model (SWAN) for wave simulation in the Black Sea". *Continental Shelf Research*. Vol. 50-51, pp. 80-99. 2012.
- [7] G.J. Komen, L. Cavaleri, M. Donelan, K. Hasselmann, S. Hasselmann, P.A.E.M. Janssen, Dynamics and modelling of ocean waves. Cambridge University Press, Cambridge. 1994.
- [8] P.A.E.M. Janssen, "Quasi-linear theory of wind-wave generation applied to wave forecasting". *Journal of Physical Oceanography*. Vol. 21, pp. 1631–1642. 1991.
- [9] P.A.E.M. Janssen, "Consequences of the effect of surface gravity waves on the mean air flow", *Int. Union of Theor. and Appl. Mech. (IUTAM)*, Sydney, Australia, pp. 193-198. 1991.
- [10] W.E. Rogers, P.A. Hwang, D.W. Wang, "Investigation of wave growth and decay in the SWAN model: three regional-scale applications". *Journal of Physical Oceanography*. Vol. 33, pp. 366–389. 2003.
- [11] S. Hasselmann, K. Hasselmann, J.H. Allender, T.P. Barnett, "Computations and parameterizations of the linear energy transfer in a gravity wave spectrum, part II: parameterizations of the nonlinear transfer for application in wave models". *Journal of Physical Oceanography*. Vol. 15 (11), pp. 1378 – 1391. 1985.
- [12] M. Zijlema, G.Ph. Van Vledder, L.H. Holthuijsen, "Bottom friction and wind drag for wave models". *Coastal Engineering*. Vol. 65, pp. 19–26. 2012.
- [13] J.A. Battjes, J.P.F.M. Janssen, "Energy loss and set-up due to breaking of random waves". In Proc. of 16th International Conference on Coastal Engineering (ASCE). 1978, Hamburg, Germany.
- [14] Y. Eldeberky, "Nonlinear transformation of wave spectra in the nearshore zone", Ph.D. thesis, Delft University of Technology, The Netherlands. 1996.
- [15] S. Saha, S. Moorthi, H-L. Pan, X. Wu, J. Wang, S. Nadigai, P. Tripp, R. Kistler, J. Woollen, D. Behringer, H. Liu, D. Stokes, R. Grumbine, G. Gayno, J. Wang, Y-T. Hou, H-Y. Chuang, H-MH. Juang, J. Sela, M. Iredell, R. Treadon, D. Kleist, P. van Delst, D. Keyser, J. Derber, M. Ek, J. Meng, H. Wei, R. Yang, S. Lord, van den H. Dool, A. Kumar, W. Wang, C. Long, M. Chelliah, Y. Xue, B. Huang, J-K. Schemm, W. Ebisuzaki, R. Lin, P. Xie, M. Chen, S. Zhou, W. Higgins, C-Z. Zou, Q. Liu, Y. Chen, Y. Han, L. Cucurull, R.W. Reynolds, G. Rutledge, G. Goldberg, "The NCEP climate forecast system reanalysis". *Bulletin of the American Meteorological Society*. Vol. 91, pp. 1015–1057. 2010.
- [16] GEBCO, British Oceanographic Data Centre, Centenary Edition of the GEBCO Digital Atlas [CDROM]. Published on behalf of the Intergovernmental Oceanographic Commission and the International Hydrographic Organization, Liverpool. 2014.
- [17] A. Akpınar, B. Bingölbali, and G.Ph. Van Vledder, "Long-term analysis of wave power potential in the Black Sea based on 31-year SWAN simulations". *Ocean Engineering*, under review.

# Managing Supply Chain Sustainability And Risks: A Real Case Study In Turkey

*Sukran Seker<sup>1</sup>*

---

## *Abstract*

*Supply Chain Sustainability is the management of environmental, social and economic impacts throughout the lifecycles of goods and services. Supply Chain Sustainability for companies can conserve resources, optimize processes, uncover product innovations, save costs, increase productivity and promote corporate values. Managing risks through supply chain sustainability is particularly important in companies. This study provides an analysis of trends and challenges for sustainable supply chains and the management of related risks with a real case application from Turkey.*

**Keywords:** *Supply Chain Management, Sustainability, Risk management.*

---

## 1. INTRODUCTION

Supply Chain Sustainability (SCS) is defined as a key point of business value and an important element of strong corporate responsibility performance. In today's increasingly flexible business environment, turbulence and uncertainty properly effect many marketplaces and significantly increase the need to consider on all of the exposures an organization may have, both internal and external. However, Supply chain risk is generally defined as the probability of supply events that may cause significant loss on the purchasing firm [1].

Sustainability and the increased exposure to risks are strongly related. Organizations must become ready for decreasing the impact of the increased global competition and the intricate risks that are available in global operations. For example, the occurrence of extra stocks of products due to forecasting errors not only means a risk for organizations in terms of costs, but also with regard to social responsibility and macroeconomic sustainability.

Economist Intelligence Unit (EIU) (2010) indicates that sustainability initiatives are very important to the boards at for the 44% of the companies, and to senior management at a 36%. However, these figures are much higher than those of any other stakeholder, whether it is middle management inside the company (19%), employees (20%) and investors (23%) - or external local communities (28%), customers (23%) and suppliers (9%). This demonstrates that management needs to do more to educate both internal and external groups on the importance of sustainability to corporate strategy. Recent studies analyse the ways companies are practically focusing on sustainability [2].

[3] and [4] present sustainability to the field of supply chain management, and ensure a framework of sustainable supply chain management (SSCM) based on resource dependence theory, transaction cost economics, population ecology, and the resource-based view of the firm. In the same studies, authors specify SSCM as the strategic, transparent integration and achievement of an organization's social, environmental, and economic goals in the systemic coordination of key interorganizational business processes for improving the long-term economic performance of the individual company and its supply chains. The optimization of transport and storage costs represents a challenge for sustainable supply chains. Conventional supply chain design was often based on so-called 'network optimization' principle [2].

The issues connected with so-called green supply chains are particularly worth of mention. In 2008, within the context of Environment Program, the United Nations launched the Green Initiative along with top economists and the support of the governments, including Germany and the European Commission. These new initiatives were clean energy and clean technologies, including recycling; rural energy, including renewables and sustainable biomass; sustainable agriculture and ecosystem infrastructure; sustainable cities, including planning, transportation and green building. All the topics related to raw material consumption, storage, waste reduction, transportation and recycling are significantly related to logistics and supply chain management.

Different authors emphasis the increasing strategic attention to – in particular - environmental protection, green transports and development of green products [2].

In this study, the importance of supply chain sustainability for any company and giving a business case for supply chain sustainability from Turkey is focused.

---

<sup>1</sup>Corresponding author: Sukran Seker, Yildiz Technical University, Department of Industrial Engineering, 34349, Besiktas/Istanbul, Turkey. [seker.sukran@gmail.com](mailto:seker.sukran@gmail.com)

## 2. THE BUSINESS CASE FOR SUPPLY CHAIN SUSTAINABILITY

Organizations should not only take into consideration the supply-chain elements for which they are directly responsible but also extend the supply-chain map at least one tier up and one tier down, obtaining direct suppliers and direct customers which includes transportation and information links for them.

Firms can also use several criteria to determine risks [5]. Pareto analysis, also known as A-B-C analysis, may help firms to identify the proportion of goods and suppliers on which it is most dependent in terms of profitability or criticality, and hence the goods and suppliers that can reveal the most risk to the supply chain. More intricate portfolio analysis can be used to identify goods by both their value and the vulnerability of supply, and lead firms to focus their SCRM first on strategic or critical goods of high value and high supply vulnerability [6].

Any sustainability activity, which significantly affects profitability, can be studied in detail within the scope of strategic planning process.

The process begins with defining internal and external environments. Organizations may inadvertently overlook internal risks. These may include unsafe conditions for employees, as well as inadequate policies, strategies, or organizational structures. The external environment in which an enterprise, and its suppliers, must work will also pose differing risks. Internal and external risks include :

### External Supply Chain Risk Categories

#### Governmental actions

- Lack of intellectual property protection, resulting in loss of revenue
- Regulatory variability, such as changing environmental regulations or labor laws

#### Infrastructure deficiencies

- Port congestion due to inadequate facilities or a lack of water depth to accommodate new, larger vessels
- Highway inadequacies resulting in delivery-causing delays or product damage

#### Supplier difficulties

- Production problems, delays, or failure to meet specifications
- Inadequate finances that limit supplier growth capability
- Social responsibility failures

#### Logistical problems

- Lack of proper equipment, including rail cars, transoceanic cargo container capacity, chassis, etc.
- Late deliveries or freight damage
- Shrinkage in transit

#### Price

- Volatility of pricing in cost-driver materials
- Exchange-rate fluctuations that result in unplanned cost increases

#### Terrorism

- Cyber attacks
- Counterterrorism requirements like early documentation submission and inspection requirements

#### Natural disasters

- Super storms
- Earthquakes

#### Accidents

- Errors in judgment that cause supplier delays
- Mistakes such as defects in production, inventory picking errors, etc.

### Internal Supply Chain Risk Categories

#### Policies

- Low-bid policies that require purchase from a low bidder and do not consider capability
- FOB destination (“free on board”: the point at which title transfers from seller to buyer) that is easy for the buying organization, since suppliers manage transportation, but disguises transportation costs because costs are rolled into the delivered price the supplier charges
- Ethical policies that allow some gratuities, which invite transgressions

#### Resources

- Financial resources that are inadequate to serve customer requirements into the future
- Labor qualifications, sufficient numbers, and labor relations
- Technology: communications, automation, enterprise resource planning

#### Operational

- Quality defect rates that are unacceptable
- Productivity rates that are not competitive
- Forecasting

#### Time compression

- Delayed engineering, while project due dates remain constant
- Delayed ordering, resulting in “rush” orders, which are expensive and risky for both buyer and supplier [1].

The business case for supply chain sustainability for a particular company depends on a variety of issues including industry sector, region of operation, stakeholder expectations, business strategy, organizational culture, and past performance.

In the following section the trends and challenges for sustainable supply chains and the management of related risks with a real case application worldwide known from Turkey in pharmaceutical industry is investigated.

### 3. CASE STUDY

Firm A was one of the first companies to aim treatments to patients. With its combined strength in pharmaceuticals and diagnostics, it is better designed than any other company for further perform personalized healthcare. Two-thirds of their Research and Development projects are being carried out with companion diagnostics. It has been targeted to improve lives since the company was founded in 1896 in Basel, Switzerland. Today, the firm generates innovative medicines and diagnostic tests that help millions of patients globally. Medicines and diagnostic tests, which are manufactured in company’s facilities located in various countries, are then shipped to Turkey according to sales forecasts and supply orders accepted, and are imported as finished products upon the authorization of the Ministry of Health.

The firm’s Turkey’s relations with business partners focus on to the quality, competitive prices, compliance, sustainability and integrity. Firm A, works actively with 1000 suppliers while Diagnostics works with 850 suppliers. 91% of the firm A suppliers are local firms while this rate is 95% for the firm A Diagnostics. Since firm A has no manufacturing activities in Turkey, the Procurement Department makes in direct purchases.

In investment activities for community, the firm does not restrain itself to certain areas but make an effort to obtain the highest possible benefit from its projects. The firm performs exemplary activities in the healthcare industry, and it also supports activities in infrastructure, environment and education by producing high quality and leading projects with its services in these areas. With its global approach and local creative solutions, Firm A in Turkey is carried out to increase the quality of health and life.

Finished Product Warehouse is the location of imported products under appropriate storage conditions in Firm A. All boxes are given QR codes due to the Pharmaceuticals Track & Trace System implemented in Turkey. Patient information leaflets and box labels prepared in Turkish are also placed in/on some products arriving in boxes printed in a foreign language in Firm A’s Finished Product Warehouse. Products accepted by its quality unit become ready for sale.

Products are arranged in line with the orders received from its customers and shipped under appropriate conditions. Products to be kept under normal temperature conditions are delivered to the customer’s address in Istanbul or to a warehouse stated by the customer outside Istanbul. Cold chain products are delivered to the customer’s address within Istanbul via temperature-controlled vehicles or to the courier companies to the customers outside Istanbul. Validated transportation packages are used for the shipment of cold chain products sent by courier.

The firm also evaluate its existing or potential suppliers through an “Anti- Corruption Compliance Form”. Reviewed jointly by the department assigning the job and the Procurement Department, this form helps them to review the compliance-related characteristics of its business partners with a risk-based approach. If actions are required, necessary processes and methods are determined. In 2014, this evaluation was made for 26 suppliers of Firm A Pharma and 2 suppliers of Firm A Diagnostics and no risky situations were encountered.

The Procurement Department is responsible for conducting the appropriate Supplier Relations Management in line with the specific requirement criteria of the respective category / product / merchandise / service. At the Procurement Department, they

try to act as a business partner of internal customers in order to make sure that their needs are correctly identified. They provide a competitive environment and treat each supplier fairly and equally. Relevant criteria are developed for the selection of suppliers according to the category and applied based on principle of transparency. The process is directed and documented by taking audit and compliance requirements into account. Their criteria for the selection of suppliers include the volume of procurement, degree of risk, sectoral position/importance of the supplier as well as their behavior and attitude in ethics, compliance and sustainability.

It is important for company that their products are made available to patients in the most healthy and safest way by maintaining the same conditions after they are shipped to pharmaceutical wholesalers according to suitable storage and shipment conditions (cold chain). Therefore, pharmaceutical wholesalers are required to adhere to the storage and transportation conditions of these products.

They have a full Risk Management Policy, which sets out their approach for identifying, managing and reporting internal and external risks and opportunities. They also use stakeholder feedback to help manage social, environmental and economic risks and opportunities.

Group Risk Report, which includes all material risks, is annually reviewed with the Corporate Executive Committee and discussed by the Board of Directors. The Group Risk Management team provides advisory services to sites, affiliates, project and product teams. It observes risk patterns in specialist areas such as social media, IT security, compliance and sustainability. E-Learning programs, classroom training and workshops are sources to improve the manage and understanding of risk them appropriately.

Additionally, the firm has existed incident management teams throughout the firm Group for emergencies. Efforts are performed to strengthen the business continuity management to provide that all its sites respond effectively to catastrophic events which may occur.

Because risk management is obtained from a broader perspective and is under the responsibility of every manager, the firm works on a local reporting system that was launched in 2015. With regard to these efforts, all relevant unit managements expect to identify their risks, identify and implement the relevant actions and update their risk reports on the activities in each quarter of year.

Since risk management is under the responsibility of every manager, in 2015, they are planning to establish 3 committees, called as Asset Management Committee, Contract Follow-up Committee and Distributor Management Committee, comprising of employees from different departments in order to better manage the risks in areas of especially economic sustainability and partially compatibility and competition.

However, The Pharmaceutical Supply Chain Initiative (PSCI) is a group of leading pharmaceutical companies that share the vision of achieving better social, economic and environmental outcomes for everybody involved in the pharmaceutical supply chain, and has developed the Pharmaceutical Industry Principles for Responsible Supply Chain Management. Being an active member of PSCI, Firm A is committed to apply these principles and expects the same from its suppliers. Firm A works together with other large pharmaceutical companies as part of PSCI in sustainability audits.

#### 4. CONCLUSIONS

Managing risks through supply chain sustainability is particularly important in companies. By mitigating and responding to sustainability risks in the supply chain, companies can control costs, protect their market share, and reduce risk priorities. In this study, trends and challenges for sustainable supply chains and the management of related risks with a real case application worldwide known from Turkey in pharmaceutical industry are investigated.

The aim of this study is to lay emphasis on the sustainability of supply chain management (SSCM) for any company and to represent the efforts of a worldwide known firm on SSCM. It is also known that the success and reputation of the firm is strongly depend on applying SSCM, successfully. By mitigating and responding to sustainability risks in the supply chain, companies can control costs, protect their market share, and reduce risk premiums. It is believed that our success lies in our ability to represent strategies of a pharmaceutical firm worldwide known where both industry and society benefit in a sustainable way.

#### REFERENCES

- [1]. Lee Buddress "Managing Supply Chain Sustainability and Risk", No. DN-V6N13 JULY 2014 Director Notes
- [2]. M. Christopher and B. Gaudenzi, "Managing risks in sustainable supply chains", Italian Journal of management Vol. 33, No: 96, 2015.
- [3]. C.R Carter, D.S. Rogers, "A framework of sustainable supply chain management: moving toward new theory", International Journal of Physical Distribution and Logistics Management, vol. 38, n. 5, pp. 360-387. 2008.
- [4]. C.R. Carter, P.L. Easton, "Sustainable supply chain management: evolution and future directions", International Journal of Physical Distribution and Logistics Management, vol. 41, n. 1, pp. 46-62, 2011.
- [5]. Y Moore., A. Clifford Grammich, and R. Bickel, "Developing Tailored Supply Strategies", Santa Monica, Calif.: RAND Corporation, 2007. As of May 22, 2011; <http://www.rand.org/pubs/monographs/MG572.html>.
- [6]. Supply Chain Risk Leadership Council. "Supply Chain Risk Management: A Compilation of Best Practices." Aug. 2011. Web. <[http://www.scrcl.com/articles/Supply\\_Chain\\_Risk\\_Management\\_A\\_Compilation\\_of\\_Best\\_Practices\\_final\[1\].pdf](http://www.scrcl.com/articles/Supply_Chain_Risk_Management_A_Compilation_of_Best_Practices_final[1].pdf)>

# Effects of Ensiling Time on Chemical Compositions of Maize Silages

Ismail Ulger<sup>1</sup> Mahmut Kaplan<sup>2</sup>

---

## Abstract

The present study was conducted to investigate the effects of ensiling durations on nutritional composition of maize silage. For this purpose, chopped maize samples were ensiled in 3-liter glass jars for 7, 14, 21, 28, 35, 42, 49 and 56 days. Ensiling duration significantly increased crude protein (CP) and crude oil (CO) CP contents of maize silage ( $P < 0.05$ ). The initial pH value of 4.43 decreased to 3.87 at the end of 56 day ensiling period. On the other hand, there were not any significant changes in dry matter (DM), crude ash (CA), ADF and NDF content of maize silage throughout 56-day ensiling period ( $P > 0.05$ ). Current findings revealed that increasing ensiling durations created significant decreases in pH contents and increases in CP and CO contents. It was concluded that minimum ensiling duration for maize silage should not be less than 40 days.

**Keywords:** Maize, silage quality, ensiling duration, conservation, nutritional composition

---

## 1. INTRODUCTION

Meat, milk and egg-like animal products have a great place in human nutrition. In Turkey, feed costs constitute the primary input of livestock facilities (50-70%). Quality roughage plays a significant role especially in feeding of high-yield animals. About half of total daily feed needs of dairy cows is met with roughage. In this way, well operation of animal digestive system is provided and with created nutrient balance it is possible to get desired quality and quantity yield. Quality silage is quite rich in energy and more delicious and nutritious than the other feeds. Silage is also an economic feed source and may significantly reduce the production cost of meat and milk [1].

With several benefits, silage is an essential nutrient source for ruminant feeding. Therefore, the quality and nutritional composition of silages are quite significant issues for livestock facilities. There may be some nutrient losses during the ensilage period. Such losses may vary based on silage structure and silage material, harvest period of the material, the way of ensilage and the other conditions to be obeyed during the ensilage. These losses generally observed at different stages throughout the ensiling period. They may be experienced at field while harvest and chopping of the green herbage, on the way to the silo while transporting them, or in silo during the fermentation of the material. All these losses may sometimes reach to 25-30% of the total material in weight and may also result in serious quality losses [2]. It is evident that the silage with great losses in nutrients may not provide any benefits in reaching desired milk or meat needs.

The present study was conducted to investigate the variations in nutrient composition of the maize silage throughout the ensiling period and to determine potential losses. Experimental outcomes will provide significant contributions for better management of silage processes.

## 2. MATERIALS AND METHODS

The maize to be ensiled was supplied from the fields of Agricultural Research and Implementation Center of Erciyes University. Samples were taken from maize plants before making the silage. Then the plants were chopped in 3 cm pieces. They were homogenized and placed in 3-liter glass jars. Lids were tightly closed as not have any air. A total of 24 silage were prepared.

The silage samples were opened at 7, 14, 21, 28, 35, 42, 49 and 56th day in 3 replications. About 25 g samples were taken from each jar in accordance with the method specified as in [3]. They were mixed in 100 ml distilled water for 5 minutes, homogenized and pH values were measured. Dry matter (DM), crude protein (CP) crude oil (CO) and crude ash (CA) analyses were performed in accordance with the methods specified in [4]. Acid detergent fiber (ADF) and neutral detergent fiber (NDF) analyses were performed in accordance with the principles specified as in [5].

Experimental data were subjected to statistical analyses with SPSS (Statistical Package for the Social Sciences, version 14.0) software. Single-way ANOVA analysis was performed to compare the groups and multiple range tests were used to identify the differences between the groups.

---

<sup>1</sup> Erciyes University, Faculty of Agriculture, Department of Animal Science, 38039, Kayseri, Turkey. [i\\_ulger@hotmail.com](mailto:i_ulger@hotmail.com)

<sup>2</sup> Corresponding author: Erciyes University, Faculty of Agriculture, Department of Field Crops, 38039, Kayseri, Turkey, [mahmutk@erciyes.edu.tr](mailto:mahmutk@erciyes.edu.tr)

### 3.RESULTS AND DISCUSSION

The effects of fermentation (ensiling) duration on nutritional composition of maize silage are provided in Table 1.

Table 1. The effects of fermentation (ensiling) duration on nutritional composition of maize silage

Parameters	Ensiling duration (days)									SEM
	0	7	14	21	28	35	42	49	56	
DM (%)	35.76	35.54	35.46	35.21	34.95	34.78	34.42	34.19	33.94	0.369
pH	4.43 <sup>a</sup>	4.34 <sup>a</sup>	4.21 <sup>ab</sup>	4.16 <sup>ab</sup>	4.10 <sup>ab</sup>	4.03 <sup>b</sup>	3.98 <sup>b</sup>	3.93 <sup>bc</sup>	3.87 <sup>c</sup>	0.098
CP (% DM)	5.65 <sup>d</sup>	5.73 <sup>cd</sup>	5.79 <sup>c</sup>	5.82 <sup>c</sup>	5.97 <sup>bc</sup>	6.07 <sup>ab</sup>	6.18 <sup>ab</sup>	6.24 <sup>ab</sup>	6.30 <sup>a</sup>	0.140
CA (% DM)	4.55	4.52	4.60	4.57	4.50	4.45	4.46	4.39	4.40	0.111
CO (% DM)	2.57 <sup>c</sup>	2.62 <sup>bc</sup>	2.67 <sup>bc</sup>	2.74 <sup>b</sup>	2.80 <sup>b</sup>	2.88 <sup>b</sup>	2.94 <sup>a</sup>	3.03 <sup>a</sup>	3.09 <sup>a</sup>	0.164
ADF (% DM)	21.59	21.46	21.37	21.28	21.22	21.17	21.08	20.91	20.87	0.233
NDF (% DM)	42.55	42.41	42.47	42.34	42.25	42.18	42.05	41.87	41.69	0.301

<sup>a, b, c, d, e, f</sup>: The difference between the means indicated with different letters in the same line is significant; SEM: Standard Error of Means; DM: Dry Matter; CP: Crude Protein; CA: Crude Ash; CO: Crude Oil; ADF: Acid Detergent Fiber; NDF: Neutral Detergent Fiber.

As seen in Table 1, fermentation duration did not have significant effects on DM content of maize silage ( $P>0.05$ ). On the other hand, fermentation durations had significant effects on crude protein (CP) and pH values of maize silage ( $P<0.05$ ), but did not have significant effects on crude ash (CA) contents ( $P>0.05$ ). Again as seen in Table 1, fermentation durations had significant effects on crude oil (CO) contents of maize silage ( $P<0.05$ ), but did not have significant effects on ADF and NDF contents of silage samples ( $P>0.05$ ).

There was a decrease in DM contents of silage samples with increasing ensiling durations, but such a decrease was not significant ( $P>0.05$ ). The initial DM content of 35.76% decreased to 33.04% at the end of 56 day fermentation period. The pH values also decreased throughout the ensiling period and the initial pH value of 4.43 decreased to 3.87 at the end of 56 day ensiling period. The decrease in pH was found to be significant ( $P<0.05$ ). Similar decreases in pH values with increasing ensiling durations were also reported by previous researchers (e.g. [6], [7]).

Similar to findings of some previous studies (e.g. [8], [9], [10]), the initial CP content of 5.45% increased to 6.70% at the end of 56th day and such an increase with increasing ensiling durations was found to be significant ( $P<0.05$ ). The effects of fermentation durations on CA contents were not found to be significant ( $P>0.05$ ). There was an irregular increase in crude ash contents of samples with increasing ensiling durations.

Effects of fermentation durations on crude oil (CO) contents of maize silage were found to be significant ( $P<0.05$ ). The initial CO value of 2.47% increased to 3.36% at the end of 56 day ensiling duration. Similar increases in CO contents with increasing ensiling durations were also reported by [11] and [12]. Finally, the effects of fermentation duration on ADF and NDF contents of maize silage were not found to be significant ( $P>0.05$ ).

### 4.CONCLUSIONS

Considering the current findings, it was concluded that while increasing ensiling durations created significant decreases in pH values of maize silage, but increased CP and CO contents of the silage samples. It was finally concluded that the minimum ensiling duration for maize silage should not be less than 40 days.

### REFERENCES

- [1] M. Görgülü, *Süt Sığırlarının Beslenmesi ve Yemler*, ser. AB ve Türkiye’de Danışmanlık Sistemleri ve Süt Sığırı İşletmelerinin Yönetimi. S. Kumlu, Ed. Aydın, Turkey: TR0703.01-02/FA, pp.123-198, 2012.
- [2] H. R. Kutlu, *Yem değerlendirme ve analiz yöntemleri*, Çukurova Üniversitesi Ziraat Fakültesi Zootečni Bölümü, Unpublished, Adana, Turkey: ZM 208, 2008.
- [3] C. E. Polan, D. E. Stieve, and J. L. Garrett, “Protein preservation and ruminal degradation of ensiled forage treated with heat, formic acid, ammonia, or microbial inoculants,” *J. Dairy Sci.*, vol. 81, pp. 765-776, 1998.
- [4] AOAC, *Official Methods of Analysis: Association of Official Analytical Chemists*, 15th ed., Washington, DC: AOAC, Vol. 1. pp. 69-79, 1990.
- [5] H. K. Goering, and P. J. Van Soest, *Forage Fiber Analysis (Apparatus, Reagents, Procedures and Some Applications)*, Washington, DC: Agricultural Hand-Book, No: 379, pp. 11-19, 1975.
- [6] C. Herrmann, M. Heiermann, and C. Idler, “Effects of ensiling, silage additives and storage period on methane formation of biogas crops,” *Bioresource Technology*, vol. 102, pp. 5153-5161, 2011.
- [7] M. A. Bal, “Effects of hybrid type, stage of maturity, and fermentation length on whole plant corn silage quality,” *Turkish Journal of Veterinary and Animal Sciences*, vol. 30, pp. 331-336, 2006.
- [8] M. S. Yahaya, M. Kawai, J. Takahashi, and S. Matsuoka, “The effects of different moisture content and ensiling time on silo degradation of structural carbohydrate of orchardgrass,” *Cellulose*, vol. 30, pp. 27-25, 2002.

- [9] J. W. Cone, A. H. Van Gelder, H. A. Van Schooten, and J. A. M. Groten, "Effects of chop length and ensiling period of forage maize on in vitro rumen fermentation characteristics," *NJAS-Wageningen Journal of Life Sciences*, vol. 55, pp. 155-166, 2008.
- [10] B. Çakmak, H. Yalçın, and H. Bilgen, "Hasıl ve Fermente Mısır Silajlarının Ham Besin Maddesi İçeriği ve Kalitesine Paketleme Basıncı ve Depolama Süresinin Etkileri," *Tarım Bilmileri Dergisi*, vol. 19, pp. 22-32, 2013.
- [11] J.R. Benton, T. J. Klopfenstein, and G. E. Erickson, "Effects of corn moisture and length of ensiling on dry matter digestibility and rumen degradable protein," *Nebraska Beef Report MP. Univ. of Nebraska, Lincoln*, vol. 83, p. 31, 2005.
- [12] A. B. Bodine, G. D. O'dell, M. E. Moore, and C. K. Wheat, "Effect of dry matter content and length of ensiling on quality of alfalfa silage," *Journal of Dairy Science*, vol. 66, pp. 2434-2437, 1983.



# Some Fruit Characteristics of Superior Walnut Genotypes Collected From Cappadocia Region of Turkey

Aybey Imamoglu<sup>1</sup>, Aydin Uzun<sup>2</sup>

---

## Abstract

*In present study seed propagated walnut genotypes selected from Nevşehir provinces and some towns located in Cappadocia region of Turkey were investigated. During the selection process firstly 54 walnut genotypes with high yield were determined. Approximately 40 fruit samples were collected from each genotypes and some fruit parameters were evaluated. According to results significant differences were found among the genotypes. Fruit length of genotypes ranged between 27.8-46.8 mm. Fruit height and width of genotypes varied among 26.8-39.2 and 27.1-38.2 respectively. Fruit weight of walnut genotypes were found from 7.8 to 16.5 g as average 11.7 g. The highest fruit weight was obtained from 'genotype 13' selected from 1500 m of altitude in Urgup town. Fruit endocarp weight of selected genotypes were ranged between 3.8-7.9 g and average of 5.8 g. Among the selected walnuts some promising genotypes were determined. Results of this study may contribute to increase of walnut production and breed new cultivars.*

**Keywords:** Genetic Resources *Juglans Regia*, Selection Breeding, Turkey

---

## 1. INTRODUCTION

Turkey has quite deep-rooted and ages-old fruit culture and it is the origin of several fruit species including walnut [1]. Walnut has a natural spread over large areas extending from Eastern Europe, Turkey, Iraq and Iran to beyond the Himalayas [2]. World annual walnut production is about 3.45 million tons and China is the leading producer. Turkey with 212 thousand tons of production has the fourth place in World walnut production [3]. Majority of the production is consumed as dry food stuff.

There are quite rich seed-propagated walnut populations in various parts of Turkey. As it was in other fruit species, walnut is also foreign pollinated and seed propagation creates various new variations. Such variations then create a broad diversity with regard to fruit and tree characteristics in years. Therefore, there is a need for selection and breeding works to be carried out in different regions of the country identify new high-quality walnut species from these rich genetic resources. Walnut selection researches have been conducted in various parts of Turkey and several promising types have been identified with these researches ([4], [5], [6], [7], [8], [9], [10], [11], [12], [13],[14],[15]).

The objectives in walnut selection and breeding works are to identify and propagate the genotypes with superior fruit characteristics, high fruit yields over side branches, late foliage and flowering as not to be influenced from spring late frosts, homogamy or protogeny exhibiting and resistant to leaf burns and anthracnose ([5], [16], [17], [18]). In present study, some fruit characteristics of promising walnut types selected from walnut populations in Nevşehir province of Cappadocia region of Turkey were put forth.

## 2. MATERIAL AND METHODS

The walnut trees at yield maturity in Nevşehir city center, Avanos and Ürgüp towns and Yeşilöz, Ortahisar, Nar, Özkonak, Göynük, Sarılar, Çavuşin, Bozca districts and villages with rich walnut populations constituted the plant material of this study. A total of 1000 walnut trees were evaluated and 54 of them were selected with regard to yield and fruit characteristics and without any disease symptoms.

Fruit weight, fruit length, fruit width, fruit height, fruit endocarp weight and fruit shape of selected genotypes were analyzed. Among the biochemical characteristics, crude oil and protein contents were determined in accordance with the previous studies ([10], [12], [19]). For investigated fruit characters, data were analyzed using JMP trial version (SAS Institute Inc.) and means were separated and grouped using Tukey's test ( $P < 0.05$ ). Differences among selected genotypes were put forth and ultimately superior ones were identified.

## 3. RESULTS AND DISCUSSION

---

<sup>1</sup> \*corresponding author: [uzun38s@yahoo.com](mailto:uzun38s@yahoo.com)

Nevşehir Hacı Bektaş University Avanos Vocational High School, Nevşehir, Turkey

<sup>2</sup> Erciyes University Department of Horticulture, Kayseri, Turkey

Among the genotypes, there was high level of variation with regard to investigated traits. Fruit weights varied between 7.9 – 16.6 g and significant variations were observed in fruit weights of the genotypes. Genotype 13 (16.6 g) and genotype 41 (16.4 g) had the highest fruit weights (Table 1). There were significant differences in fruit kernel weights and kernel ratios of the genotypes. The greatest kernel weight was observed in genotype 41 (7.9 g) and 40 (7.8 g). Fruit kernel ratios varied between 63.4% (genotype 50) and 34.3% (genotype 47). In a selection study carried out in Hatay region, fruit weights were reported as between 10-16.37 g, kernel weights as between 4.03-8.07 g and kernel ratios as between 37-58.70% ([10]). In another study carried out in Bayındır locality of İzmir Province, fruit weights of selected genotypes were reported as between 11.70-19.66 g, kernel weights as between 3.64-9.26 g and kernel ratios as between 30.92-62.44% ([20]). The fruit weights of walnut genotypes selected from Isparta region was reported as between 7.89-12.98 g, kernel weights as between 4.04-5.75 g and kernel ratios as between 48.44-57.64 ([21]). Fruit weights of walnut genotypes grown in Harşit valley varied between 10.54-15.82 g, kernel weights varied between 5.44-8.40 g and kernel ratios varied between 47.32-59.01% ([22]). In a study carried out in Bingöl region, fruit weights of 40 genotypes varied as between 9.98-15.75 g, kernel weights varied as between 5.05-6.87 g and kernel ratios varied as between 38.41-54.54% ([23]). In another study carried out in Kayseri province, fruits weights were reported as between 6.14-18.10 g, kernel weights as between 2.24-8.41 g and kernel ratios as between 34.36-55.57% ([15]). The present outcomes on fruit weights comply with those results of above mentioned earlier studies.

Among the walnut genotypes, the greatest shell thickness was observed in genotypes 38 (2.28 mm) and 21 (2.17 mm) and the lowest shell thickness was observed in genotypes 26 (1.01 mm) and 50 (0.76 mm) (Table 1). In previous studies carried out in different regions of Turkey, walnut shell thicknesses were reported as between 0.53-1.77 mm ([6]), 0.57-1.92 mm ([24]), 1.23-1.83 mm ([22]), 1.04-1.69 mm ([25]) and 0.85-2.00 ([23]). Of the 55 genotypes sampled in this study, 10 had light endocarp color, 6 had yellow, 33 had brunette and 6 had dark endocarp color. In a previous study, light-yellow endocarp ratio of 26 genotypes were reported as between 50-100% ([5]). Reference [26] reported light-color endocarp ratio of Çatak region as 50%. Reference [23] in a study carried out in Bingöl and surroundings, reported for 40 walnut genotypes that 8 had light color, 19 had yellow and 13 had brunette color. Light color shells have higher market value. In modern breeding works, light color is a desired characteristics (Paris, 2013) and light color ones were pointed out in present study.

Table 1. Some fruit characteristics of selected walnut genotypes

GN	FW (g)	KW (g)	KR (%)	ST (mm)	KC	PL(%)
1	11,7 e-o	5,8 a-j	49,6 b-j	1,8 c-f	Y	19,6±0,3
2	11,6 e-o	4,5 f-j	38,3 k-l	1,7 c-i	B	16,3±0,4
3	7,9 Q	3,8 i-j	50,8 b-j	1,4 g-r	B	18,5±2,3
4	11,9 e-n	4,9 e-j	40,9 i-l	1,7 c-j	B	17,9±2,9
5	8,9 n-q	4,0 i-j	50,1 b-j	1,3 l-s	B	18,1±0,1
6	9,6 k-q	5,4 a-j	52,4 a-g	1,5 d-o	L	14,3±0,0
7	9,5 l-q	5,1 d-j	55,4 a-e	1,4 h-q	B	21,7±0,7
8	10,1 i-q	5,2 b-j	50,0 b-j	1,6 c-j	Y	15,3±0,1
9	8,6 o-q	5,3 b-j	53,7 a-e	1,4 j-r	Y	18,6±2,6
10	10,5 h-q	5,2 c-j	49,6 b-j	1,6 c-k	Y	14,5±0,1
11	13,5 a-h	6,7 a-h	51,7 b-i	1,5 d-o	B	14,1±2,0
12	15,6 a-c	5,9 a-j	38,2 k-l	1,8 b-d	B	16,7±0,7
13	16,6 A	7,3 a-e	45,6 e-k	1,7 c-j	B	16,1±0,1
14	13,1 b-i	5,2 c-j	39,5 j-l	1,6 c-m	Y	13,7±0,2
15	11,6 e-o	6,1 a-j	53,2 a-f	1,5 d-o	B	11,9±0,0
16	10,3 i-q	6,3 a-j	55,4 a-e	1,4 i-q	Y	16,3±3,2
17	11,8 e-n	6,2 a-j	54,3 a-e	1,8 c-g	L	15,1±3,2
18	14,4 a-e	7,4 a-e	53,6 a-f	1,5 d-o	B	13,0±0,1
19	13,2 b-i	6,9 a-g	52,3 a-g	1,6 c-j	D	15,2±0,1
20	10,8 g-q	5,5 a-j	51,6 b-i	1,2 p-s	B	13,9±0,0
21	16,0 a-b	7,6 a-d	47,0 d-k	2,2 ab	B	16,5±0,1
22	12,7 c-k	5,5 a-j	46,3 e-k	1,5 e-p	B	15,7±1,1
23	12,6 c-l	6,4 a-j	48,3 c-k	1,6 c-n	B	15,2±2,6
24	10,6 h-q	6,3 a-j	60,4 a-b	1,2 p-s	L	21,1±1,2
25	12,2 d-m	6,9 a-g	57,9 a-d	1,3 k-s	D	19,2±2,5

26	8,2	p-q	5,2	c-j	58,6	a-c	1,0	s-t	B	14,9±1,3
27	9,5	l-q	4,9	e-j	52,0	b-ı	1,5	f-p	D	18,8±1,0
28	11,6	e-o	5,9	a-j	52,1	b-h	1,5	f-p	B	22,3±0,0
29	13,8	a-g	7,0	a-f	46,7	e-k	1,8	c-e	L	17,1±0,4
30	12,1	d-m	6,5	a-ı	49,2	c-k	1,7	c-ı	L	15,9±1,2
31	14,2	a-f	6,6	a-h	45,9	e-k	1,5	f-p	Y	14,6±0,0
32	14,4	a-e	5,5	a-j	41,0	h-l	1,8	c-g	B	19,3±0,6
33	12,8	c-j	6,4	a-j	52,6	a-g	1,7	c-j	B	16,8±0,1
34	11,2	f-p	5,1	d-j	45,6	e-k	1,9	bc	B	16,3±0,2
35	13,1	b-ı	6,0	a-j	44,7	e-l	1,8	c-h	Y	16,7±0,2
36	11,1	f-p	4,6	f-j	42,5	f-l	1,6	c-j	B	22,0±0,4
37	11,7	e-o	5,8	a-j	50,9	b-ı	1,7	c-j	B	16,9±0,2
38	9,9	j-q	4,1	h-j	38,1	k-l	2,3	a	Y	18,1±0,0

G.N: Genotype No; FW: Fruit weight; KW: Kernel weight; ST: Shell thickness; KC: Kernel color; PL: Protein level  
Y: Yellow; B: Brunette; L: Light; D: Dark

Table 1. Continued

GN	FW (g)	SW (g)	KR (%)	ST (mm)	KC	PL (%)				
39	11,3	e-p	6,0	a-j	52,9	a-f	1,7	c-j	L	11,9±0,3
40	15,2	a-d	7,8	a-b	49,1	c-k	1,8	c-f	B	10,7±0,1
41	16,4	A	8,0	a	44,9	e-l	1,9	bc	B	20,2±0,3
42	10,5	h-q	5,9	a-j	55,6	a-e	1,2	m-s	L	21,1±0,1
43	13,5	a-h	6,1	a-j	46,5	e-k	1,6	c-j	B	16,4±0,6
44	12,2	d-m	6,3	a-j	50,1	b-j	1,1	r-t	Y	16,3±0,5
45	11,2	f-p	5,4	a-j	50,8	b-ı	1,6	c-n	Y	12,9±0,3
46	10,1	ı-q	6,2	a-j	54,9	a-e	1,5	d-o	L	15,7±3,1
47	11,9	e-n	4,0	ı-j	34,3	ı	1,8	c-d	B	15,3±0,2
48	9,5	m-q	4,4	g-j	46,1	e-k	1,2	o-s	L	11,6±0,1
49	11,4	e-o	5,2	b-j	46,6	e-k	1,1	q-s	B	17,2±0,1
50	11,9	e-n	7,7	a-c	63,4	a	0,8	t	Y	13,4±0,1
51	8,9	n-q	3,9	j	46,2	e-k	1,5	d-o	B	14,9±0,3
52	10,6	h-q	5,0	d-j	47,7	c-k	1,6	c-l	L	14,5±3,1
53	12,1	d-m	5,1	c-j	41,5	g-l	1,2	n-s	B	17,1±2,3
54	10,3	ı-q	6,1	a-j	48,8	c-k	1,7	c-j	L	13,8±0,5

G.N: Genotype No; FW: Fruit weight; KW: Kernel weight; ST: Shell thickness; KC: Kernel color; PL: Protein level  
Y: Yellow; B: Brunette; L: Light; D: Dark

While the greatest protein ratios were observed in genotypes 28 (22.35%) and 36 (22.03%), the lowest values were seen in genotypes 40 (10.71%) and 48 (11.65%). Present findings generally comply with the results of earlier studies. However, in a previous local study, protein content of selected promising types reported as between 16.06-25.50% ([27]). In another study carried out in Ermenek region, protein contents were reported as between 12.11-20.75% ([28]). In a study carried out in Tavas region of Denizli province, protein ratios were reported as between 11.31-17.69% ([29]).

Considering the statistical evaluation of different fruit and biochemical characteristics together, it was observed that 5 out of 55 genotypes were prominent. These promising genotypes were identified as the genotypes 24, 50, 31, 16 and 8. It was concluded that present outcomes might provide significant contributions for the identification of quality types among the natural walnut populations of Turkey and for the preservation of these valuable genetic resources.

## REFERENCES

- [1]. Şen, S.M., 2011. Ceviz Yetiştiriciliği, Başak Matbaacılık, Ankara, 220 s (in Turkish).
- [2]. Akça, Y., 2005. Ceviz Yetiştiriciliği. Tarım ve Köyişleri Bakanlığı Yayın Daire Bşk. Matbaası, Ankara, 239 s (in Turkish)
- [3]. FAO, 2013. Faostat. Statistic Database <http://faostat3.fao.org/download/Q/QC/E> (Accessed on 24.09.2016)
- [4]. Ölez, H., 1971. Marmara Bölgesi Cevizlerinin (*Juglans Regia* L.) Seleksiyon Yolu İle Islahı Üzerinde Araştırmalar. (Doktora Tezi) Bahçe Kültürleri Araştırma Enstitüsü Merkezi Yalova (in Turkish).
- [5]. Şen, S. M., 1980. Kuzey Doğu Anadolu ve Doğu Karadeniz Bölgesi Cevizlerinin (*Juglans regia* L.) Seleksiyon Yolu İle Islahı Üzerinde Araştırmalar. Atatürk Üniversitesi, Ziraat Fakültesi Bahçe Bitkileri Bölümü, Doçentlik Tezi, Erzurum, 140 s (in Turkish).
- [6]. Şen, S. M., Tekintaş, F. E., 1992. A Study on the selection of Adilcevaz walnut. Acta Horticulturae, 317: 171-174.
- [7]. Akça, Y., 1993. Gürün Cevizlerinin (*Juglans regia* L.) Seleksiyon Yolu İle Islahı Üzerinde Araştırmalar. (Doktora Tezi, Y.Y.Ü. Fen Bilimleri Enstitüsü, Van (in Turkish)
- [8]. Özkan, Y., 1993. Tokat Merkez İlçe cevizlerinin Seleksiyon Yolu ile ıslahı Üzerine Araştırmalar. (Doktora Tezi Basılmamış), Y.Y.Ü. Fen Bilimleri Enstitüsü Van, 123 s (in Turkish).
- [9]. Küden, A., Kaska, N., Türemiş, N., 1995. Walnut selection in middle Taurus Mountains. Acta Horticulturae, 442: 117-119.
- [10]. Bayazıt, S., 2000. Hatay Yöresi Cevizlerinin Seleksiyon Yoluyla Islahı Üzerinde Araştırmalar. Mustafa Kemal Üniversitesi, Fen Bilimleri Enstitüsü, Yüksek Lisans Tezi, 93 s (in Turkish)
- [11]. Yavuç, A., 2000. Bahçesaray Yöresi Cevizlerinin (*Juglans regia* L.) Seleksiyon Yoluyla Islahı Üzerine Araştırmalar. YYÜ. Fen Bilimleri Enstitüsü., Doktora Tezi, Van, 85 s. (in Turkish).
- [12]. Muradoğlu, F., 2005. Hakkari Merkez İlçe ve Ahlat (Bitlis) Yöresinde Tohumdan Yetiştirilmiş Ceviz (*Juglans regia* L.) Popülasyonunda Genetik Değişkenlik ve Ümitvar Genotiplerin Seleksiyonu. (Basılmamış, Doktora Tezi), YYÜ. Fen Bilimleri Enstitüsü. Van, 157 s (in Turkish).
- [13]. Yarılgaç, T., Yıldız, K., Balta, M.F., Tekintaş, F.E., 2002. Gevaş ve Edremit yöresi ceviz (*Juglans regia* L.) popülasyonunda bazı meyve karakterlerinin tekrarlanma dereceleri ile beklenen verim değerlerinin tahmini. IV. Ulusal Bahçe Bitkileri Sempozyumu, s: 249-251 Antalya (in Turkish).
- [14]. Demir, Z., 2007. Siirt Yöresinde Doğal Olarak Yetişen Cevizlerin (*Juglans regia* L.) Seleksiyonu. Yüzüncü Yıl Üniversitesi, Fen Bilimleri Enstitüsü, Yüksek Lisans Tezi, Van (in Turkish).
- [15]. Paris, K., 2013. Kayseri ilinde Ceviz (*Juglans Regia* L.) Seleksiyon Yolu İle Araştırmalar. Erciyes Üniversitesi, Fen Bilimleri Enstitüsü, Yüksek Lisans Tezi (in Turkish).
- [16]. Mc Granahan, G., Leslie, C., 1991. Walnuts. (Ed: James N. Moore & James R. Ballington Jr. Acta Horticulturae, 290: 905-953 pp.
- [17]. Yarılgaç T., 1997. Gevaş Yöresi Cevizlerinin (*Juglans regia* L.) Seleksiyon Yolu İle Islahı Üzerinde Araştırmalar. Yüzüncü Yıl Üniversitesi, Fen Bilimleri Enstitüsü, (Doktora Tezi) Van, 152 s (in Turkish).
- [18]. Atefi, A., 2001. Comparison of some promising iranian walnut clones and foreign varieties. Acta Horticultura, 544: 51-59.
- [19]. Kaymaz, Ö., 2005. Hizan (Bitlis) Merkez İlçe Ceviz (*Juglans regia* L.) Popülasyonlarında Ümitvar Genotiplerin Seleksiyonu Üzerine Bir Araştırma. Yüzüncü Yıl Üniversitesi, Fen Bilimleri Enstitüsü, Yüksek Lisans Tezi (Yayınlanmamış), Van (in Turkish).
- [20]. Doğan, A., Oğuz, H.İ., Gün, A., Askın, M.A., 2005. Bayındır (İzmir) yöresinde selekte edilen bazı ümitvar ceviz (*Juglans regia* L.) genotiplerinde meyve özelliklerinin belirlenmesi. Bahçe 34 (1): 117-121 (in Turkish).
- [21]. Koyuncu A. M., Koyuncu F., Yıldırım A. F., Dilmaçınal T., Vural E., 2005. Gelincik (Isparta) Doğal Ceviz Genotiplerinin Yan Dal Verimliliği ve Meyve Özelliklerinin Belirlenmesi Bahçe Dergisi Özel Sayısı, 34(1); 73-82 (in Turkish).
- [22]. Karadeniz, T., 2007. Harşit Vadisinde Yetiştirilen Cevizlerin Seleksiyon Yoluyla Islahı Üzerinde Araştırmalar. Türkiye V. Ulusal Bahçe Bitkileri Kongresi: 631-637. Erzurum (in Turkish).
- [23]. Kalan, C., 2011. Bingöl Yöresinde Doğal Olarak Yetiştirilen Cevizlerin (*Juglans regia* L.) Seleksiyonu. Yüzüncü Yıl Üniversitesi, Fen Bilimleri Enstitüsü, Yüksek Lisans Tezi, Van, 113 s (in Turkish).
- [24]. Akça, Y., Ayhan, C., 1996. Adilcevaz ceviz (*Juglans regia* L.) popülasyonu içinde genetik değişkenlik ve üstün özellikli ceviz tiplerinin seleksiyonu üzerinde bir araştırma. Fındık ve Diğer Sert Kabuklu Meyveler Sempozyumu: 380-387 (in Turkish)
- [25]. Muradoğlu, F. ve Balta F., 2007. Hakkari Yöresi Cevizlerinin (*Juglans regia* L.) Seleksiyon Yolu ile Islahı, Türkiye 5. Ulusal Bahçe Bitkileri Kongresi: 294-298, Erzurum (in Turkish).
- [26]. Şahinbaş, T., 2001. Çatak ve Yöresi Cevizlerinin Seleksiyon Yolu İle Islahı Üzerine Araştırmalar. Yüzüncü Yıl Üniversitesi, Fen Bilimleri Enstitüsü, Yüksek Lisans Tezi, Van (in Turkish).
- [27]. Ünver, H., 2005. Ankara Yöresi Cevizlerinin (*Juglans regia* L.) Seleksiyon Yolu İle Islahı. Ankara Üniversitesi, Fen Bilimleri Enstitüsü, Doktora Tezi, Ankara, 124s (in Turkish).
- [28]. Oğuz H.İ., Aşkın A., 2007. Ermenek Yöresi Cevizlerinin (*Juglans regia* L.) Seleksiyon Yoluyla Islahı Üzerine Bir Araştırma. Yüzüncü Yıl Üniversitesi, Ziraat Fakültesi, Tarım Bilimleri Dergisi, 2007, 17(1): 21-28 (in Turkish).
- [29]. Çelik F., Cimrin K.M., Kazankaya A., 2011. Tavas (Denizli) Yöresinden Selekte Edilen Ceviz (*Juglans regia* L.) Genotiplerinin Bazı Fiziksel ve Kimyasal Özellikleri. Yüzüncü Yıl Üniversitesi Tarım Bilimleri Dergisi, 21 (1): 42-48 (in Turkish).

# Comparison of the calibrated SWAN models' performances forcing with different winds in the Black Sea

Adem Akpınar<sup>1</sup>, Bilal Bingolbali<sup>2</sup>

---

## Abstract

The aim of this study is to compare the performances of the calibrated SWAN models forcing with several re-analyses (ERA-Interim, MERRA, and CFSR) and one operational dataset (ECMWF). For this, the SWAN model is firstly calibrated for each wind independently. The calibration is based on white-capping progress and its tunable parameter ( $C_{ds}$ ). The model outputs are assessed against buoy measurements at three locations (Gelendzhik, Hopa, and Sinop). The best calibrated SWAN model for each wind is determined. The comparisons between performances of the calibrated SWAN models forcing with several winds are made in terms of Taylor diagrams and statistical error indicators—namely bias, scatter index, root mean square error, and correlation coefficient for wave parameters  $H_{m0}$  and  $T_{m02}$ . The results show that although the quality of the wave hindcasts in terms of their comparisons with observations differs, it is observed that Janssen formulation for white-capping is more suitable for the SWAN model for all winds and lower  $C_{ds}$  parameter provides more accurate results. Besides, the differences between the calibrated SWAN models' performances are relatively small but the calibrated SWAN model using the CFSR winds are of higher accuracy than those using other winds. Scatter indexes for the best model are 38% for  $H_{m0}$  and 20% for  $T_{m02}$  at Gelendzhik, 49% for  $H_{m0}$  and 24% for  $T_{m02}$  at Hopa, and 33% for  $H_{m0}$  and 18% for  $T_{m02}$  at Sinop. The mean scatter index value for all locations is 40% for  $H_{m0}$  and 21% for  $T_{m02}$ . This shows that the results of the calibrated SWAN model forcing with the CFSR winds are in agreement with the measurements.

**Keywords:** wave hindcast; SWAN; wind forcings; Black Sea

---

## 1. INTRODUCTION

The state of the art in medium- and large-scale wave modeling today is the third-generation wave model, which solves the spectral action balance equation without prior assumption of spectral shape (e.g., [1 - 3]). The skill of these models has been demonstrated in numerous validation exercises. Typically, comparisons of bulk parameters such as gross wave height, peak period, and mean wave direction are made, in which these models generally perform well. In deep water, growth and decay are a function of propagation and three primary source terms that are active at all depths: wind input, four-wave interactions, and dissipation. Dissipation in deep water is commonly referred to as “breaking” or “whitecapping.” Whitecapping is widely believed to be the least accurate of the three terms. That source term is used as a tunable closure mechanism. The models are tuned to match expressions for equilibrium and quasi-equilibrium wave states (typically, [4]) [5].

Simulating Waves Nearshore (SWAN) wave model [3] is a third-generation numerical wave model, which represents the state-of-art of wave modeling. In principle SWAN could be applied to both coastal regions and open sea. Currently SWAN is widely used for theoretical and application purposes. Therefore, we used the SWAN model to investigate effect of some adaptations for whitecapping. Besides, it is well known that quality of the winds used an input to the numerical model is of primary effect. Therefore, we aim to investigate performances of the calibrated SWAN models, based on whitecapping, forcing with various wind fields. In all test runs, other physical source terms were tuned as the default in SWAN while numerical setting is based on Akpınar et al. [6].

## 2. CALIBRATION OF SWAN MODEL

The SWAN model is firstly calibrated for each wind independently. The calibration is based on whitecapping progress and its tunable parameter ( $C_{ds}$ ). We considered five different combinations of source term formulations describing wind input and whitecapping because they have different formulations in SWAN, other settings were not varied.

- ✓ Combination 1 (C1): Komen for wind input and Komen for whitecapping (denoted as KK in Taylor diagrams)
- ✓ Combination 2 (C2): Janssen for wind input and Komen for whitecapping (denoted as JK in Taylor diagrams)
- ✓ Combination 3 (C3): Komen for wind input and Janssen for whitecapping (denoted as KJ in Taylor diagrams)
- ✓ Combination 4 (C4): Janssen for wind input and Janssen for whitecapping (denoted as JJ in Taylor diagrams)

---

<sup>1</sup>Corresponding author: Uludağ University, Department of Civil Engineering, 16059, Nilüfer/Bursa, Turkey. [ademakpinar@uludag.edu.tr](mailto:ademakpinar@uludag.edu.tr)

<sup>2</sup>Uludağ University, Department of Civil Engineering, 16059, Nilüfer/Bursa, Turkey. [arda\\_bilal\\_49@hotmail.com](mailto:arda_bilal_49@hotmail.com)

- ✓ Combination 5 (C5): Yan for wind input and Westhuysen for whitecapping (denoted as YW in Taylor diagrams)

At all combinations, a lot of SWAN models were run using lower and higher values than default value of whitecapping coefficient ( $C_{ds}$ ). And thus, the best (calibrated) model was selected based on min [bias, SI, rmse] and max [correlation] for both wave parameters ( $H_{m0}$  and  $T_{m02}$ ) from data of 1996 at all buoys. The model outputs are assessed against buoy measurements at three locations (Gelendzhik, Hopa, and Sinop). More details on application of model calibration can be found in Akpınar et al. [7]. The best calibrated SWAN model for each wind was determined based on min error and max correlation in terms of Taylor diagrams and statistical error indicators. Performances of all test runs performed for each wind were illustrated in Figure 1 – 4. As these plots, for all winds the best setting was obtained from the combination (C3). In SWAN model forcing with the CFSR winds tuning of  $C_{ds} = 1.5$  had a significant improvement while in SWAN models forcing with other winds tuning of  $C_{ds} = 0.15$  had a significant improvement.

### 3.CONCLUSION

This study compares the calibrated SWAN models' performances forcing with different winds in the Black Sea. The results show that although the quality of the wave hindcasts in terms of their comparisons with observations differs, it is observed that Janssen formulation for white-capping is more suitable for the SWAN model for all winds and lower  $C_{ds}$  parameter provides more accurate results. Besides, the differences between the calibrated SWAN models' performances are relatively small but the calibrated SWAN model using the CFSR winds are of higher accuracy than those using other winds. Scatter indexes for the best model are 38% for  $H_{m0}$  and 20% for  $T_{m02}$  at Gelendzhik, 49% for  $H_{m0}$  and 24% for  $T_{m02}$  at Hopa, and 33% for  $H_{m0}$  and 18% for  $T_{m02}$  at Sinop. The mean scatter index value for all locations is 40% for  $H_{m0}$  and 21% for  $T_{m02}$ . This shows that the results of the calibrated SWAN model forcing with the CFSR winds are in agreement with the measurements.

### ACKNOWLEDGMENT

The authors would like to acknowledge Prof. Dr. Erdal Özhan of the Middle East Technical University, Ankara, Turkey, who was the Director of the NATO TU-WAVES, for providing the buoy data at Gelendzhik, Hopa, and Sinop, and the NATO Science for Stability Program for supporting the NATO TU-WAVES project.

We would like to thank the ECMWF, NCEP CFS team, and NASA for providing their wind data, the NOAA (General Bathymetric Chart of the Oceans, GEBCO) for the providing the bathymetry data of the Black Sea. We would like to thank bachelor students Ceren Özer, Beyzanur Teke, and M. Cihat Suvacı of the first author.

A part of this paper was funded by TUBITAK (The Turkish National Science and Technology Foundation) under the grant number 214M436. The authors are grateful to TUBITAK for supporting the study.

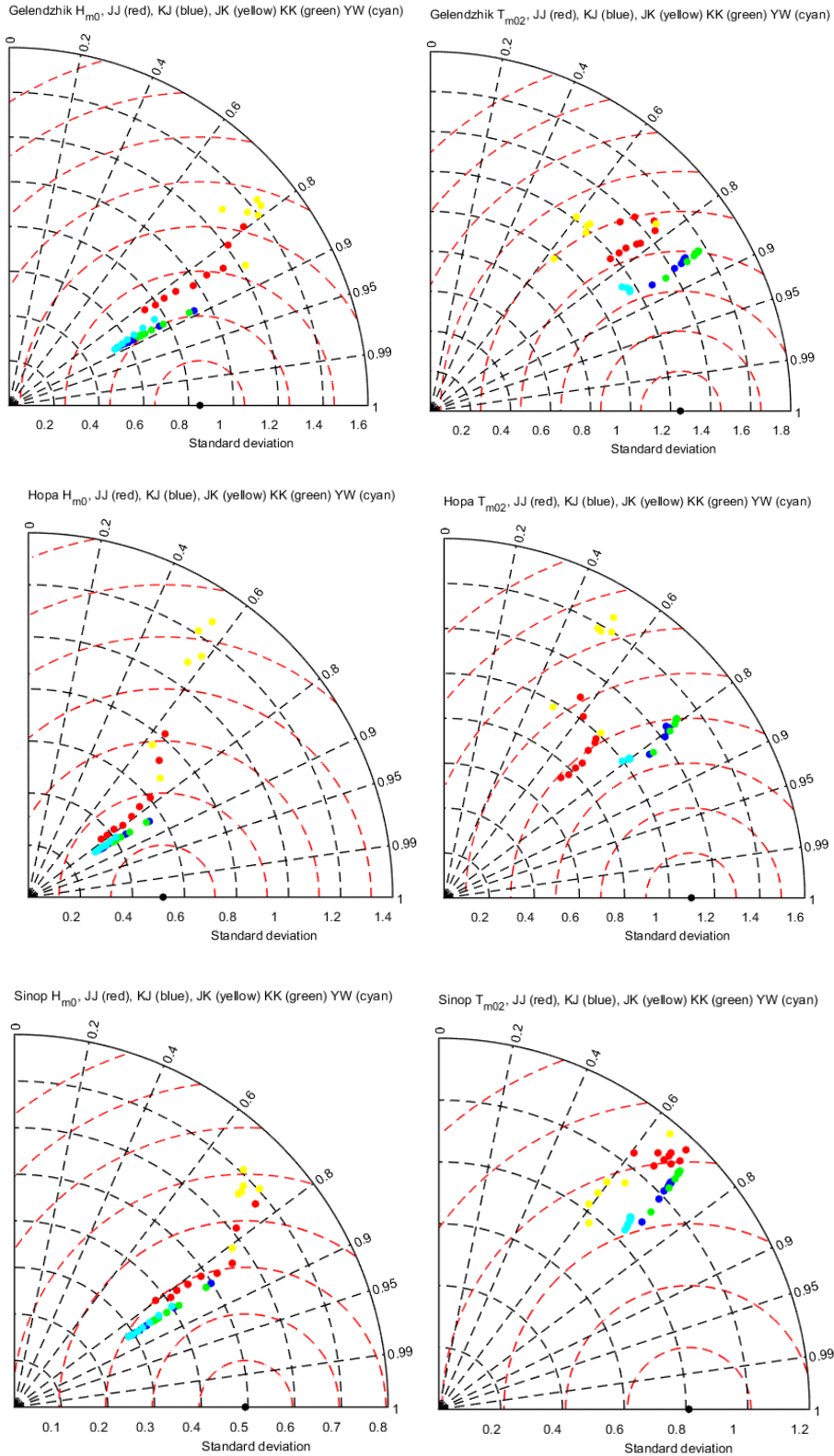
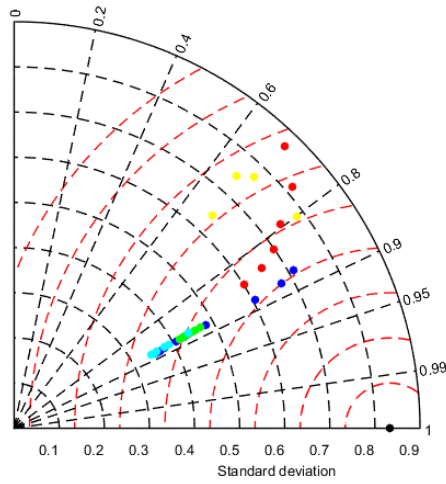
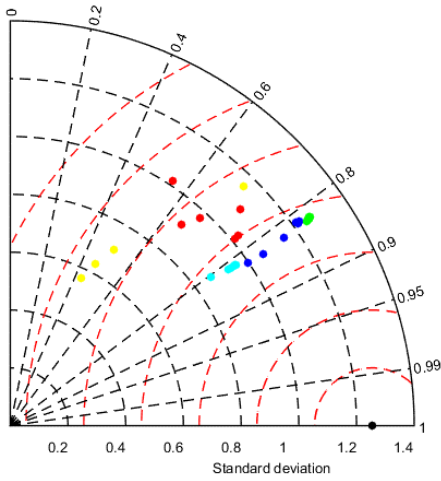

Figure 14. Taylor diagrams presenting model performances of test runs forcing with the CFSR winds for  $H_{m0}$  and  $T_{m02}$  at three buoy locations

Gelendzhik  $H_{m0}$ , JJ (red), KJ (blue), JK (yellow) KK (green) YW (cyan)



Gelendzhik  $T_{m02}$ , JJ (red), KJ (blue), JK (yellow) KK (green) YW (cyan)



Hopa  $H_{m0}$ , JJ (red), KJ (blue), JK (yellow) KK (green) YW (cyan)

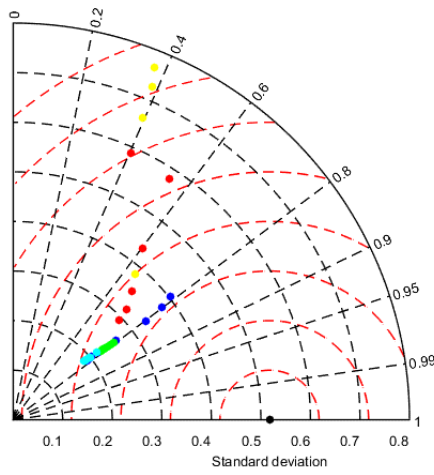



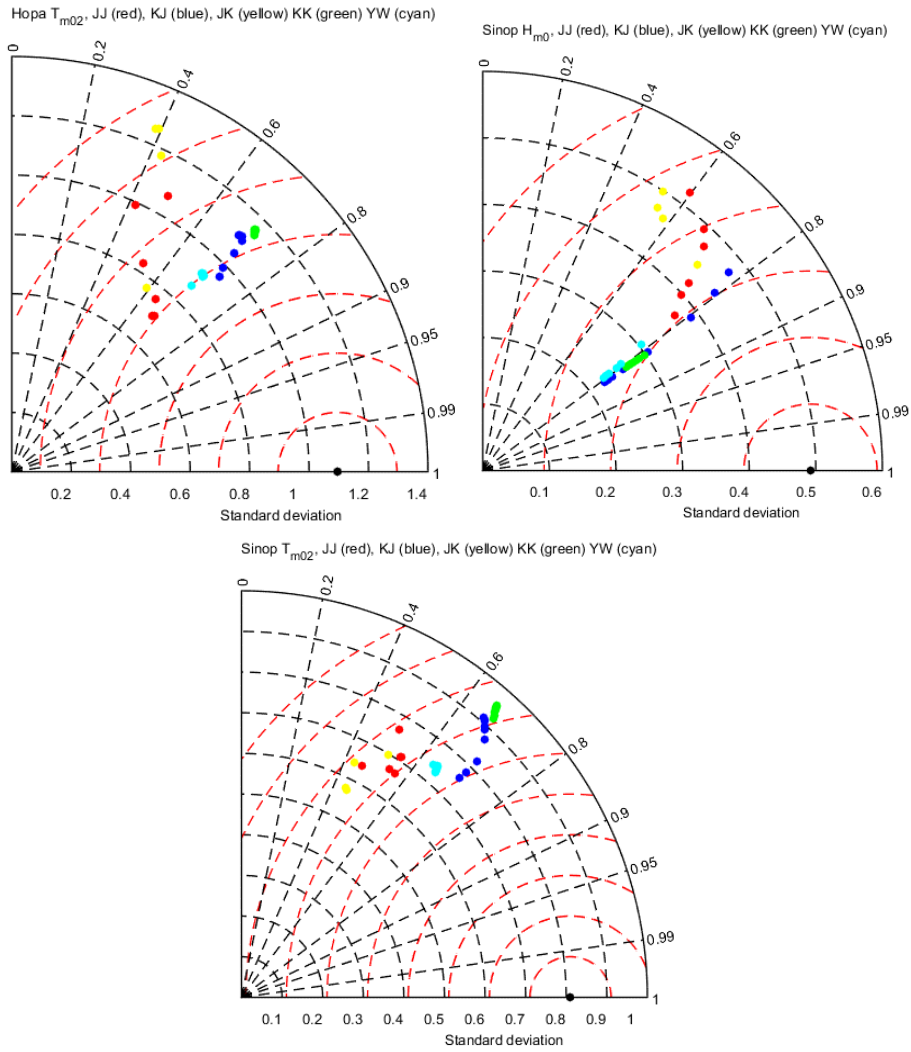

Figure 15. Taylor diagrams presenting model performances of test runs forcing with the ERA Interim winds for  $H_{m0}$  and  $T_{m02}$  at three buoy locations

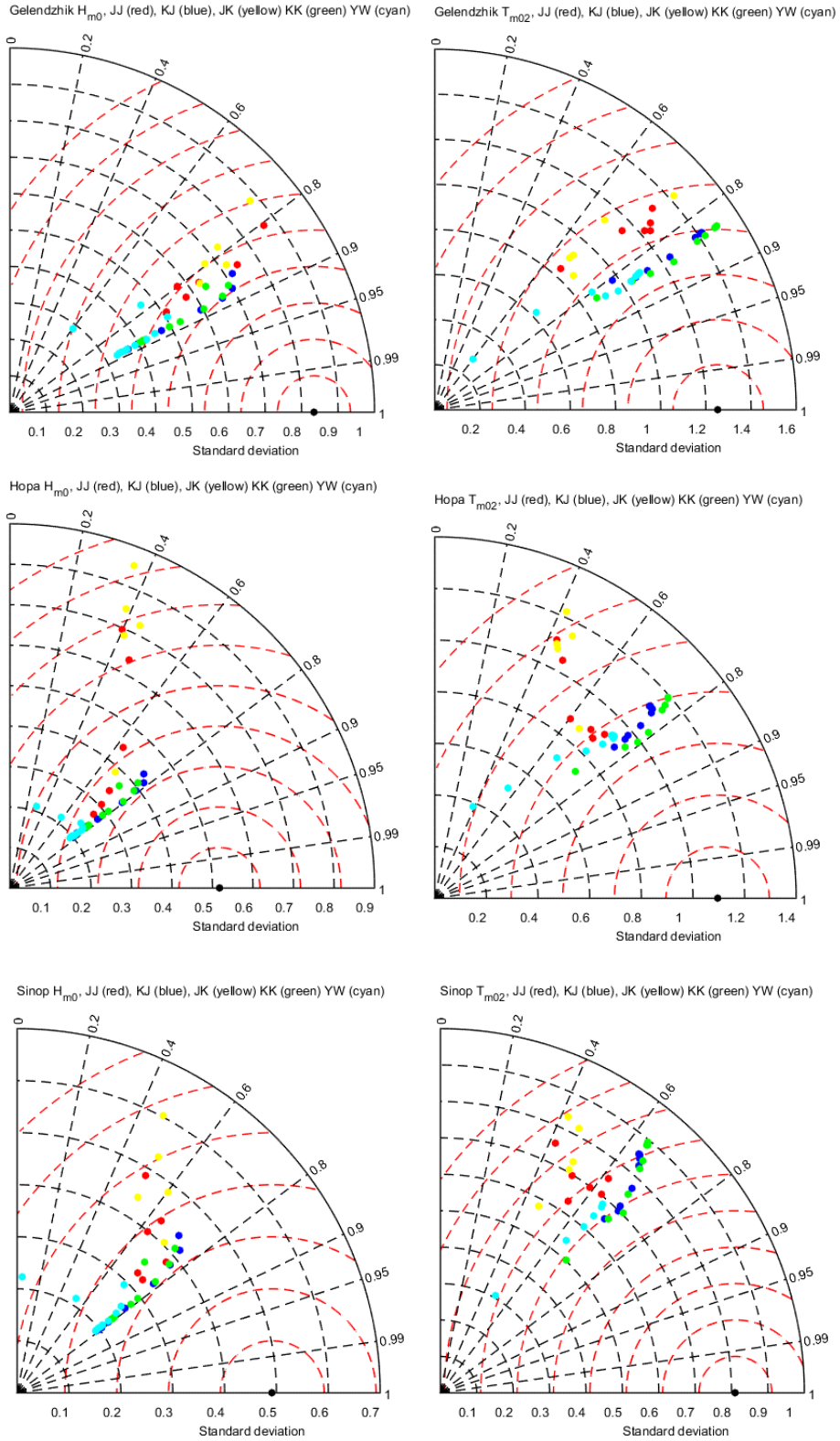

Figure 16. Taylor diagrams presenting model performances of test runs forcing with the MERRA winds for  $H_{m0}$  and  $T_{m02}$  at three buoy locations

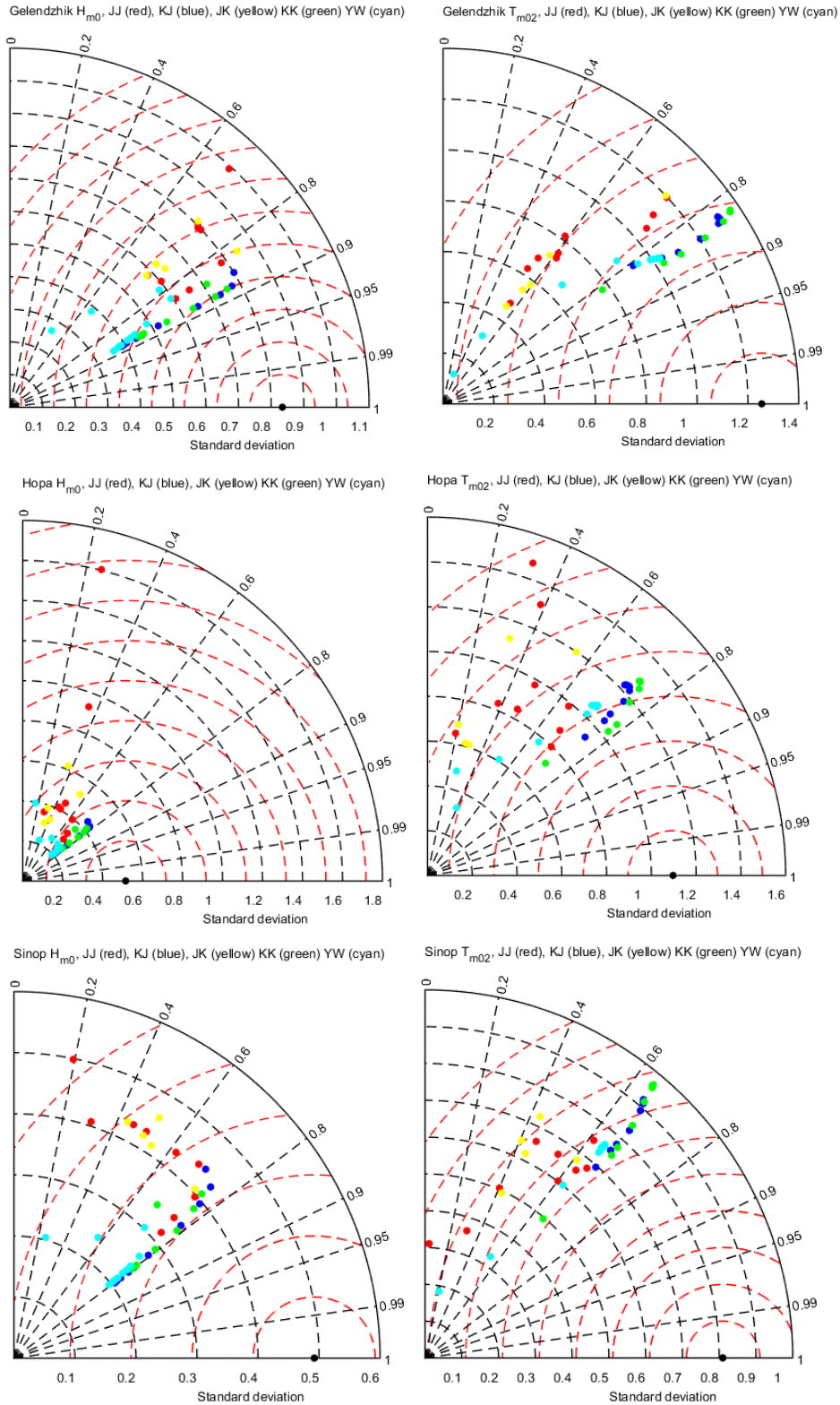

Figure 17. Taylor diagrams presenting model performances of test runs forcing with the ECMWF Operational winds for  $H_{m0}$  and  $T_{m02}$  at three buoy locations

Table 4. Error statistics of  $H_{m0}$  and  $T_{m02}$  simulated from the calibrated SWAN models forcing with the various winds at three buoy locations

Location	Forcing	Wind input formulation	Whitcapping formulation	$C_{ds}$	$H_{m0}$				$T_{m02}$			
					r	bias	rmse	SI	r	bias	rmse	SI
Gelendzhik	<b>CFSR</b>	Komen	Janssen	1.50	<b>0.88</b>	<b>0.08</b>	<b>0.41</b>	<b>0.38</b>	<b>0.86</b>	<b>0.33</b>	<b>0.79</b>	<b>0.20</b>
	<b>ERA Interim</b>	Komen	Janssen	0.15	0.87	0.07	0.42	0.41	0.82	0.64	0.96	0.24
	<b>MERRA</b>	Komen	Janssen	0.15	0.87	0.10	0.42	0.41	0.83	0.39	0.79	0.20
	<b>Operational</b>	Komen	Janssen	0.15	0.88	0.04	0.40	0.40	0.83	0.57	0.90	0.23
Hopa	<b>CFSR</b>	Komen	Janssen	1.50	<b>0.84</b>	<b>0.01</b>	<b>0.28</b>	<b>0.49</b>	<b>0.81</b>	<b>0.62</b>	<b>0.95</b>	<b>0.24</b>
	<b>ERA Interim</b>	Komen	Janssen	0.15	0.79	0.00	0.32	0.55	0.73	0.60	0.97	0.24
	<b>MERRA</b>	Komen	Janssen	0.15	0.79	-0.03	0.32	0.56	0.77	0.46	0.85	0.21
	<b>Operational</b>	Komen	Janssen	0.15	0.78	0.03	0.33	0.57	0.75	0.52	0.92	0.23
Sinop	<b>CFSR</b>	Komen	Janssen	1.50	<b>0.85</b>	<b>0.02</b>	<b>0.26</b>	<b>0.33</b>	<b>0.72</b>	<b>-0.02</b>	<b>0.69</b>	<b>0.18</b>
	<b>ERA Interim</b>	Komen	Janssen	0.15	0.78	-0.02	0.32	0.40	0.70	0.01	0.66	0.19
	<b>MERRA</b>	Komen	Janssen	0.15	0.75	0.01	0.33	0.41	0.70	0.50	0.78	0.21
	<b>Operational</b>	Komen	Janssen	0.15	0.75	0.03	0.33	0.41	0.67	0.50	0.81	0.21
Weighted Average	<b>CFSR</b>	Komen	Janssen	1.50	<b>0.86</b>	<b>0.04</b>	<b>0.32</b>	<b>0.40</b>	<b>0.80</b>	<b>0.31</b>	<b>0.81</b>	<b>0.21</b>
	<b>ERA Interim</b>	Komen	Janssen	0.15	0.81	0.01	0.35	0.45	0.75	0.42	0.86	0.22
	<b>MERRA</b>	Komen	Janssen	0.15	0.80	0.03	0.36	0.46	0.77	0.45	0.81	0.21
	<b>Operational</b>	Komen	Janssen	0.15	0.80	0.03	0.35	0.46	0.75	0.53	0.87	0.22

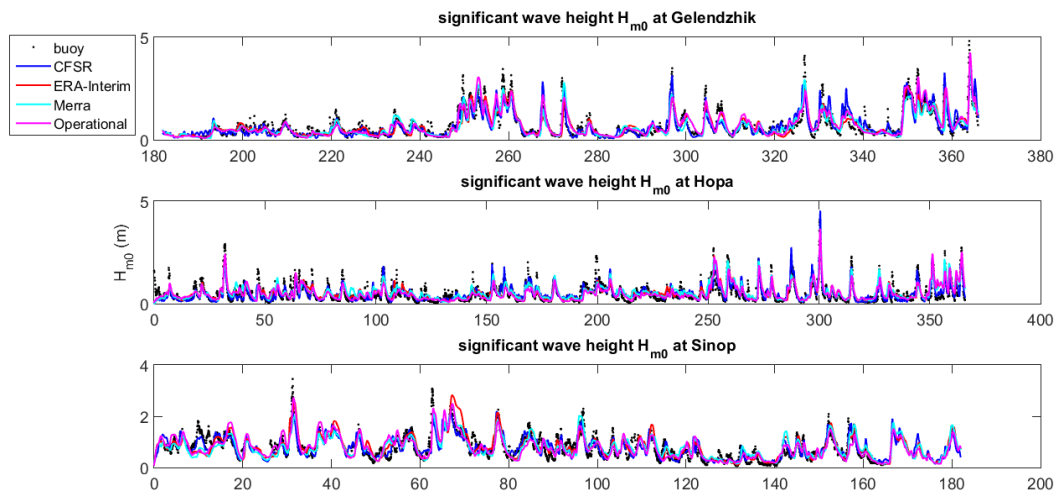

Figure 5. Time series comparison of  $H_{m0}$  simulated from the calibrated SWAN models forcing with the various winds at three buoy locations

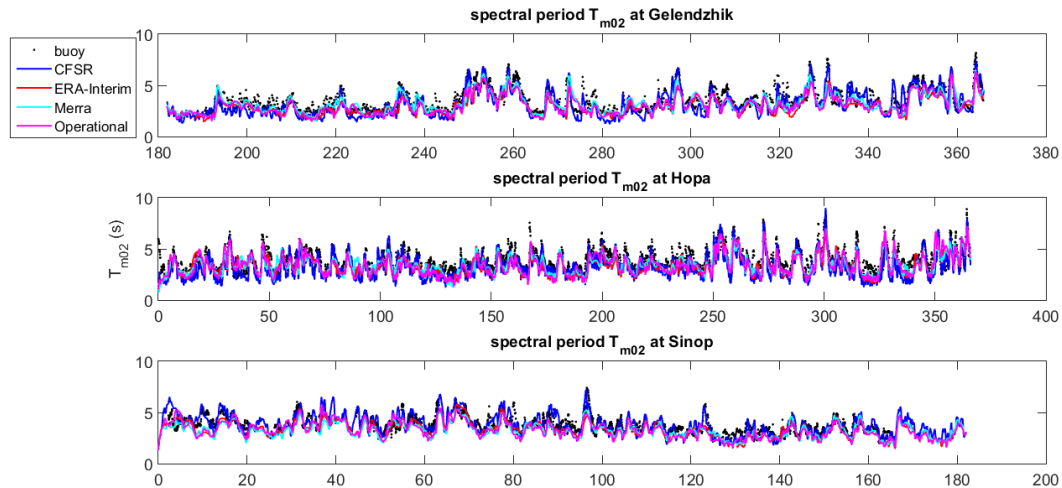

Figure 6. Time series comparison of  $T_{m02}$  simulated from the calibrated SWAN models forcing with the various winds at three buoy locations

## REFERENCES

- [1] WAMDI Group, "The WAM model—A third generation ocean wave prediction model". *Journal of Physical Oceanography*, Vol. 18, pp. 1775–1810. 1988.
- [2] H. L. Tolman, "A third generation model for wind waves on slowly varying, unsteady and inhomogeneous depths and currents". *Journal of Physical Oceanography*, vol. 21, pp. 782–797. 1991.
- [3] N. Booij, R. C. Ris, and L. H. Holthuijsen, "A third-generation wave model for coastal regions. 1. Model description and validation". *Journal of Geophysical Research*, vol. 104, pp. 7649–7666. 1999.
- [4] W. J. Pierson, and L. Moskowitz, "A proposed spectral form for fully developed wind seas based on the similarity theory of S. A. Kitaigorodskii". *Journal of Geophysical Research*, vol. 69, pp. 5181–5190. 1964.
- [5] W.E. Rogers, P.A. Hwang, D.W. Wang, "Investigation of wave growth and decay in the SWAN model: three regional-scale applications". *Journal of Physical Oceanography*, vol. 33, pp. 366 – 389. 2003.
- [6] A. Akpınar, G.Ph. van Vledder, M.İ. Kömürçü, M. Özger, "Evaluation of the numerical wave model (SWAN) for wave simulation in the Black Sea". *Continental Shelf Research* vol. 50–51, pp. 80–99. 2012.
- [7] A. Akpınar, B. Bingölbali, G.Ph. van Vledder, "Wind and wave characteristics in the Black Sea based on the SWAN wave model forced with the CFSR winds". *Ocean Engineering*, vol. 126, pp. 276 – 298. 2016.

# Application Of Product Placement And Function Of Advertisers In Turkey

*Fikret Yazıcı<sup>1</sup>Vahit İlhan<sup>2</sup>*

---

## Abstract

*In this paper, functioning of product placement application in Turkey within context of advertisers is revealed. It is aimed to reveal the reason to choose product placement application in visual media through entities which operates in Turkey and have recognizability on an international, national, regional and local level at the same time, to define sectorial and legal problems to put forward the advertisers' suggestions for solution for these problems. The study is based on the representatives of advertiser companies. While collected through the method of interview in depth, an empiric method, the data were evaluated with NVivo, a computer-aided program for data analysis, through interview and research questions. Along with conceptualization for the context, the process of product placement in Turkey within the context of advertisers was also clarified. Existing problems were defined and some solution suggestions were developed. Moreover, authentic models for the continuation of process in Turkey were developed within the context of the study. The research suggests that there are a number of legal and structural problems towards product placement in Turkey. It was also defined that product placement, will be used as an important strategy by the sector in advertising field which is developing rapidly. In terms of analysis of product placement application in Turkey within the context of advertisers, the study contributes a lot to the advertising field and the ones that are studying academically in this field.*

**Keywords:** Advertisement, Product Placement, Advertiser

---

## 1.INTRODUCTION

Product placement application is notable as one of the preferred types by the advertisers with a great enthusiasm in the changing advertising concept. The advertisers and the professionals in advertising sector plunged into a quest especially because TV viewers are anymore tired of the classic advertising spots. The product or the brand that is placed in a natural way in a TV program, a movie or in TV series does not disturb the viewer. Besides it becomes possible to establish an emotional connection between the audience and the brand or product. This case forms an important platform for the advertisers to strengthen brand image and awareness. Today all these factors are present for the choice of the product placement application increasingly.

In this study it is described how that method which we can call as new in Turkey is fictionalized in terms of the advertiser firms' perspectives. How the process is worked by the advertiser firms, which problems are faced and what solutions offered are all put forward in the study. Besides it has disclosed a perspective about which organizations would take place for the future of product placement application both in Turkey and in the world, what the expectations are and what the sectors have to do. In this regard a qualitative research method was used. Face-to-face, in-depth interview method was preferred. Representatives of advertiser firms were interviewed as the participants of the research. Comprehensive knowledge about how the process works, which problems are encountered, how these problems are solved, what the criticisms are against legal regulations and what the solution offers are to be has been demonstrated clearly in the in-depth interviews. The obtained data was evaluated systematically by the NVivo analyzing program.

## 2.PRODUCT PLACEMENT TERM

Advertisements have begun to take place highly effectively and in different mediums parallel to the technological evolution experienced by the mass media. While media planning classical concept is abandoned anymore and new approaches are adopted in transmitting the advertisement messages to the target groups. As traditional media overloads advertisements in the productions the audience escapes from the advertisements. Thus marketers seek a variety of new ways to transmit messages about brands to consumers [1]. At this point it is seen that especially new applications called as "commercial communication" determine the advertisement strategies in the developed countries.

Product placement is also seen as one of the commercial communication practices and is used often today. Legal regulations that the countries take out have also effect on this highly effective usage of product placement application. Product placement is defined as traditionally placing a branded product as planned and unobtrusively in a movie or a television programme in order to affect masses [2]. Gupta and Gould, on the other side underline that product placement recently has been used too

---

<sup>1</sup> Erciyes University, Faculty of Communication, Radio, Television and Cinema Department, 38039, Melikgazi/Kayseri, Turkey. [fyazici@erciyes.edu.tr](mailto:fyazici@erciyes.edu.tr)

<sup>2</sup> Erciyes University, Faculty of Communication, Radio, Television and Cinema Department, 38039, Melikgazi/Kayseri, Turkey. [vilhan@erciyes.edu.tr](mailto:vilhan@erciyes.edu.tr)

often as a marketing method and indicate that a very massive media tool is used in this field [3]. In the product placement application the product owner pays to the producer and based on that payment it is possible for the product to be seen on TV or cinema. Gülsoy describes the product placement as advertising implicitly in such ways as placing a branded product (such as an automobile) or an advertising of the product (such as shop signboards) in a topical movie and a TV presenter carrying a branded product (such as a beverage bottle) in a TV programme [4].

Product placement application is a process. Functioning of this process on the audience starts with the exposition of the consumers to the product placement applications in various media environments. Individuals with their cognitive ability perceive the product or the brands they encounter. Thus they make sense of the messages related to the product or brand offered to themselves indirectly. Individuals with their experiences and knowledge they acquired in the past interpret the brand and its promises and they position it in a specific place in their memories with the reference of communication environment. Thereby brand choice occurs effectively [4]. In figure 1 functioning of the product placement process at the audience level is shown.

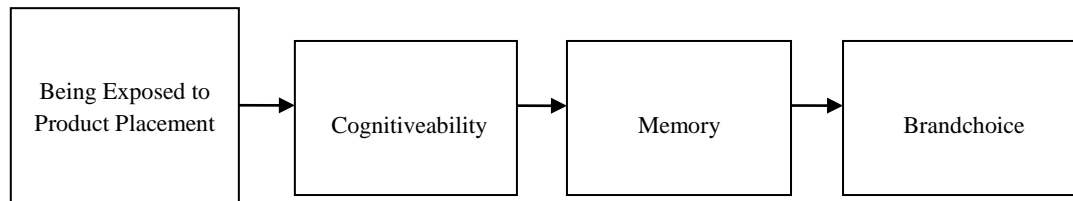

Figure 1: Functioning of the product placement process at the audience level [4].

### 3.PRODUCT PLACEMENT APPLICATION IN TURKEY

Turkey, following the expiration of the public broadcasting monopoly at the beginning of the 1990s, faced with the product placement application via commercial TV channels. Following the 6112 No Radio and Television Enterprises and Broadcast Services Law enactment in 2011 product placement application formally began to be applied. However until that day in many video clips, TV series and movies product placement applications were used. In Mustafa Sandal’s video clip “Araba” (The Car) in 1996 for example, an alcoholic beverage brand was displayed. This case sparked a public debate on hidden advertising [5].<sup>1</sup> Pekman and Gül, state that in many movies that are accepted as the pioneers of the New Turkish Cinema (Karışık Pizza-1998, Her Şey Çok Güzel Olacak-1998, Vizonte-2000) product placement application was used [6]. Nevertheless the movie G.O.R.A. (2003) in which the most striking examples of product placement application were used stands for as a milestone. 12 different brands are placed into the film both visually and verbally. But an administrative fine by the Advertising Council is given to the filmmaker Besiktas Cultural Centre (BCC) on the grounds of covert advertising. Similar sanctions have been applied in the television display of the film and other television series, too.

The product placement application in Turkey is implemented following the enactment of the 6112 No “Radio and Television Enterprises and Broadcast Services Law” published in the Official Gazette No. 27863 on the 3<sup>rd</sup> March, 2011. The 3984 No. “Law on Radio and Television Enterprises and Their Broadcasts” in effect before the 6112 No. Law does not contain any item about the product placement application. When examined, it is noteworthy that 3984 No Law used secret advertising and subliminal advertising expressions. Especially a detailed advertising duration description and highlightment of not making any abuse of children is noteworthy.

Along with the adoption of “EU Audio- Visual Media Services Directive (EU AVMSD)” in the European Union countries in 2010 and its implementation, Turkey regulated its existing audio-visual media legislation too and brought it into line with the European Union. Law No. 6112 prepared in this context implements a number of new regulations.

### 4.METHOD AND THE FINDINGS

Seven advertiser representatives serving in various sectors (banking, food, furniture and home textiles, automotive, mobile service providers and paint / decor) at local and national level in Turkey were interviewed face to face (Table 1). Interviewed advertiser firms and authorities are as follows:

<sup>1</sup> Posta, dated August 5, 1996 made news titled as follows “Musti’s car is in the grip of RTÜK (Radio Television Supreme Council) “In the news it said that “RTÜK found a hidden and forbidden advert in the video clip of Mustafa Sandal’s last hit song “araba” which costed 3,5 billion and was partly sponsored by Tuborg. RTÜK is in the view that in the scene when Sandal was waiting at the station the Tuborg billboard was zoomed [7].

Table 1: Interviewed Advertiser Firm and the Representatives

Interviewed Institution	The Interviewee	Title / Position
Turkcell	Özlem BEYENİRSOY	Marketing and Advertising Manager
Boydak Holding A.Ş (A.Ş = Inc.)	Murtaza Durmuş	Advertising and Public Relations Manager
Fiat (Tofaş)	Melike GÜLELİ	Marketing Communications Director
Şahin Sucuk	Ayşegül SÜNBLÜ	Corporate Communications and Advertising Manager
Filli Boya	Ayşe Selda UZUN	Corporate Communications Manager
Kilim Mobilya	Zeynep AKYÜREK	Advertising and Public Relations Manager
Garanti Bankası	Armağan Tulunay DÖLEK	Media Planning and Buying Manager

The study is based on the advertiser company representatives. While the data were collected through in-depth interviews as an empirical method these obtained data were subjected to qualitative interpretation process about the content. Here the purpose is to reveal how the product placement process works, and at the same time to analyze the problems and expectations about the sector through the firms.

In-depth interview method was applied in the study as one of qualitative research techniques. This is because in-depth interviews are open-ended and discovery-oriented methods. The main aim of the interviewing is to explore the feelings, the perspectives and the opinions of the interviewees deeply. The quality of the source in the interview is of great importance. The quality of the data obtained is [directly proportionate](#) to the quality of the source. Therefore the interviewees are expected to be experts in the subject of investigation or to have a decisive position on that issue [8].

The data gathered from the survey was evaluated by the program "computer assisted qualitative data analysis". For this purpose interviews in the context of thesis were subjected to analysis through NVivo program. Interviews for the study were first deciphered and the resulting texts are loaded into NVivo data analysis program.

Regarding the data obtained through in-depth interviews the views of advertiser company (firm) representatives about the product placement application in Turkey are as follows:

- Almost all of the big corporate firms in Turkey work with media planning and buying agencies and creative advertising agencies. Considering this aspect, advertiser companies provide all the information from the agencies about how the new advertising strategies should be done. Besides advertising sales representatives of TV channels inform the advertising firm representatives on certain days. The only product placement strategy that the advertisers strongly dwell on is the integration script. Integrations in literature which can be practiced in the sector are not known well enough.
- Advertisers in Turkey see the product placement as a small part of advertising activities performed for their products or brand. Therefore, they use product placement application when they need especially for the brand image and product awareness point. Here the agencies have a decisive role. Advertisers take guidance from the agencies to make product placement with the most appropriate strategy at the right time and with the right product in a most effective way.
- The advertisers know the responsibilities about how to make product placement on the screen according to the 3<sup>rd</sup> sub-article of 13<sup>th</sup> article in 6112 No. Law on Radio and Television Enterprises and Broadcast Services. They act as aware of the responsibilities that the expression in the article "product can not be over-emphasized" lay them on.
- Advertisers criticize the RTUK (Radio and Television Supreme Council) in that it keeps the TV channels under pressure. It is expressed that whether there is an over-emphasis on the placed product is a relative approach and can vary from person to person. Advertisers state that many offers for product placement from TV channels are denied only because of the fear that the RTÜK can punish them.
- It is also seen that advertisers also have the knowledge of program types that are allowed by the law for product placement. Thus they are able to make an influential audience and program selection for their product and services. Advertiser firm representatives report a positive opinion about the future of product placement application. It is underlined that this newly practiced application in Turkey started to be learnt by all the components of the sector. The more successful applications are predicted to be done in the future. Number of the placements that are creative, natural, non-irritating to the audience and strengthening brand / product image is pointed to increase day by day.
- It is foreseen that the product placement application will go through a transformation in the future and it will be especially used in digital areas mainly by the firms. That the digital areas are away from the arrangements, encourage creativity and provide a liberal environment can be shown as the reason for that.



## 5.RESULT

As a result of in-depth interviews conducted on advertisers it was determined that the desired level of professionalism in product placement application is not managed in Turkey. Because of the failure of the first applications in 2011 when the legislation was made and the sentence made by RTÜK on the grounds of excessive emphasis on products it proved that the process paused. However especially thanks to the global brands leading as pioneers successful examples appropriate to the law were determined. As a result of interviews conducted under the research, it is understood that advertising sales representatives of the channels and especially the advertising agency they work with support the firms for product placement application. The agencies that organize all the image and advertising sales campaign holds a creative process together with the TV channels focusing on the right projects. Product placement application considered as a new application is determined as a process that will function properly with synchronized work of advertising companies, advertising agencies and television channels. It was clearly expressed that time was needed for the professionalization of the process. Though failures at the beginning it was determined that highly creative product placement applications were made lately in Turkey. Television as the most effective channel for application and integration script as a strategy is used. Advertisers prefer much more to make product placement through the protagonist of the series with high viewing rates. Product placement process is affected negatively by the law articles that create diversity in reviews and complexity in meaning. It was determined that by making the necessary arrangements this situation will be overcome and the sector will be able to act more easily. Product placement application anticipated to transform into the digital media by changing form in the future is foreseen as a strategy to be preferred continuously by the advertisers.

## REFERENCES

- [1]. Y.V. Vaerenbergh, D. Van de Sompel, N.Van Look and I. Vermeir, *The Impact of Brand Name Placement in Song Lyrics on Brand Attitudes: Does the Attitude toward the Artist Matter?*, Shintaro Okazaki Ed. *Advances in Advertising Research (Vol.2) Breaking New Ground in Theory and Practice*, Gabler Verlag, Springer Fachmedien Wiesbaden. 2011, vol. 2.
- [2]. S. Balasubramanian, "Beyond Advertising and Publicity: Hybrid Messages and Public Policy Issues", *Journal of Advertising*, vol. 23. p. 29-46, 1994.
- [3]. P.B. Gupta and S.J. Gould, "Consumers' Perceptions of the Ethics and Acceptability of Product Placements in Movies: Product Category and Individual Differences", *Journal of Current Issues and Research in Advertising*, vol. 19 (1), p. 37-50, 1997.
- [4]. E. Gürel and J. Alem, *Ürün Yerleştirme*, Nobel Publishing, Ankara, Turkey: 2014.
- [5]. S. T. Ateşalp and B. Taşdemir, "Ürün Yerleştirme ve Editöryal İçerik ile İlgili Artan Kaygılar: Türkiye'de Televizyon Draması Sektörü Örneği", *Galatasaray University, Journal of Communication*, İstanbul, Turkey, vol. 21. p. 51-78. 2014.
- [6]. C. Pekman and S.T. Gül (2008). *Product Placement in Late Turkish Cinema*, [Online]. Available: [http://cim.anadolu.edu.tr/pdf/2008/2008\\_393-400.pdf](http://cim.anadolu.edu.tr/pdf/2008/2008_393-400.pdf)
- [7]. (1996) *Geçmiş Gazete* website. [Online]. Available: <http://www.gecmisgazete.com/haber-araba-si-rtuk-kiskacinda>
- [8]. T. Baş and U. Akturan. *Nitel Araştırma Yöntemleri NVivo 7.0 ile Nitel Veri Analizi*, Seçkin Publishing, Ankara, Turkey: 2008.

## BIOGRAPHY

**Fikret Yazıcı** - He was born in 1976 in Ankara. In 2000, he graduated from Istanbul University Faculty of Communication Department of Radio, Television and Cinema. In 2008, he completed his masters degree at Gazi University Institute of Social Sciences, Radio, Television and Cinema Department. He completed his PhD at Erciyes University Institute of Social Sciences, Department of Journalism in 2016. Currently he serves as a lecturer in Erciyes University Faculty of Communication, Department of Radio, Television and Cinema.

**Vahit İlhan** - Graduated from Marmara University Faculty of Communication Department of Radio-Television and Cinema in 2001. He got his master's degree in Erciyes University Institute of Social Sciences, Radio, Cinema and Television section in 2005 and completed his doctorate in Journalism Department of Erciyes University Institute of Social Sciences. Having begun his career as an academic staff of Erciyes University Faculty of Communication in 2002, he continues at the moment his carrier as associate professor in Radio, Television and Cinema Department. He has published studies in the fields of new communication technologies, communication researches, audience studies and cartoons.

# Allelopathic Potential of Some Aromatic Plant Essential Oils on *Chenopodium album* L. Seed Germination

Dogan Isik<sup>1</sup>

---

## Abstract

Allelopathy can be regarded as a component of biological control in which plants are used to reduce development of other plants. Allelopathy refers to the direct or indirect chemical effects of one plant on the germination, growth, or development of neighboring plants. The allelopathic effects of essential oil of *Mentha piperita* L.; *Thymus vulgaris* L., *Rosmarinus officinalis* L., *Coriandrum sativum* L. and *Salvia officinalis* L. on seed germination and some growth characteristics of *Chenopodium album* L. were investigated. Essential oils of medicinal plants at 0, 2, 4, 8, 16 and 32  $\mu$ L concentrations were applied to determine their inhibition effects on seed germination; seedling length and seedling root length of *C. album* seed under laboratory conditions. The essential oil of tested plant species caused inhibitory effects on seed germination and seedling length of *C. album*. Allelopathicity increased progressively with the increasing essential oil dose. The results showed that total germination inhibition of *C. album* depended on the essential oil doses; ranged from 7, 75 to 100 %. The maximum inhibition (100 %) rate for germination was obtained from the highest essential oil doses for all test species. Essential oil of *Mentha piperita* L.; *Thymus vulgaris* L., *Rosmarinus officinalis* L., *Coriandrum sativum* L. and *Salvia officinalis* L. could be used as alternatives of herbicides to suppress germination of *C. album* seeds in organic farming systems.

**Keywords:** Allelopathy, essential oil, seed germination, *Chenopodium album*.

---

## 1. INTRODUCTION

For decades, scientists have focused on boosting agricultural production needed for the fast expansion of world population. Unfortunately, substantial yield losses occur due to insects, plant diseases and weeds. Weeds are one of the major problems in world agriculture because they cause losses in crop yield [1]. Even with the intensive use of synthetic herbicides, weeds cause 10–30% crop losses, while without weed control crop losses could be 45–95%, depending on ecological and climatic conditions [2, 3]. Weed management is, therefore, a key factor of most agricultural systems.

The volume of synthetic chemical herbicides use has increased in most of the cropping systems to control weeds [1]. In order to enhance productivity and its further crop protection, globally about 3 million tons of herbicides are used annually [4]. Although synthetic herbicides have been successful in weed control, potential damage to human health and to the environment is considered today as a real problem. Intensive use of synthetic herbicides can result in soil and groundwater contamination, and development of herbicide resistant weeds [1,5,6]. Furthermore, there is potential herbicide drift injury to other crops and growing concern about herbicides residues. With these limitations, alternative approaches are needed to supplement chemical weed management [1].

Researchers have focused on new potential bio-herbicides, having different and selective herbicidal mechanisms in comparison to their equivalent synthetic herbicides in recent years. Therefore, seeking to obtain suitable natural compounds as a safe alternative source is essential for weeds management. One of the most practical alternatives to overcome these problems is the use of natural compounds having allelopathic effects on weeds in sustainable agriculture [3,5,7,8]. Allelopathy is an interference mechanism which plants release chemical compounds and they have effect on other plants. Many plants have allelopathic activity and release exudates from living tissues or by decomposition of plant residues which influence other plants in their surrounding vicinity [8,9,10,11,12]. The role of allelopathy as interactions of plant to plant and especially its potential for weed management in agriculture are considerably significant. Recently, these have received great attention due to their weed suppressing potential besides other multiple ecological roles [5,8]. A chemical ecology approach can also be taken in selecting plant species for extraction of phytotoxins. If a plant is known or suspected to be allelopathic, one should expect it to produce phytotoxic allelochemicals [13,14].

Competitive crop utilization as a means of allelopathy for weed suppression has renewed interest for agricultural systems that focus on the reduction of chemical inputs. Aromatic plants could play an important role in the establishment of sustainable agriculture because of their ability to produce essential oils that could be used in the development of biological pesticides [15]. The basic yield components of aromatic plants are biomass and essential oils.

Essential oil released from aromatic plants offers a number of ecological benefits to the plant. They act as pollinator attractants, determinants of vegetation patterning, provide protection against predators and other enemies, and mediate plant-plant

---

<sup>1</sup>Corresponding author: Erciyes University Faculty of Agriculture, Department of Plant Protection Kayseri Turkey. [dogani@erciyes.edu.tr](mailto:dogani@erciyes.edu.tr)

interactions including allelopathy [16]. Earlier studies have documented that volatile oils and their constituents are potent seed germination inhibitors and retard plant growth [17]. The growth inhibitory activity of plant essential oils has tremendously increased the interest in exploring volatile oil from aromatic plants for potential weed management [18].

Another major reason for interest in natural allelopathic phytotoxins is that they often have novel sites of action [8]. Even if the phytotoxin is unsuitable for commercial use, identification of a new molecular target site can be very valuable in the design of synthetic herbicides. Natural allelopathic compounds or preparations may require less regulatory scrutiny for registration than synthetic compounds, thus reducing the cost of commercializing the product. In other markets, synthetic herbicides are either not allowed (organic gardening) or unlikely to have long-term approval (e.g., certain aquaculture situations). Lastly, despite the relatively low priority of natural products in herbicide discovery, there have been some major successes with natural products as herbicides [8].

In weed research, one of the main purposes of studies on allelopathy is to gain insight into the mechanisms of weed/crop interactions and to utilize such information for improving the weed management strategies [19]. Furthermore, despite the fact that aromatic plants are increasingly adopted in sustainable agriculture, studies on interference between aromatic plants and weeds and the phytotoxic potential of essential oils are limited in the literature. The objective of this study was to ascertain the effects of essential oils of some aromatic plants on seed germination of weeds.

This study was conducted to investigate allelopathic effects of essential oils obtained from, mint (*Mentha piperita* L.), rosemary (*Rosmarinus officinalis* L.), coriander (*Coriandrum sativum* L.), sage (*Salvia officinalis* L.) and thyme (*Thymus vulgaris* L.), against *C. album* L., one of the most problematic weed species in most of the cultivated lands.

## 2. MATERIALS AND METHODS

Essential oils were obtained from, mint (*Mentha piperita* L.), rosemary (*Rosmarinus officinalis* L.), coriander (*Coriandrum sativum* L.), sage (*Salvia officinalis* L.) and thyme (*Thymus vulgaris* L.). The tested aromatic plant species used in the current experiment were collected at flowering stage in 2013. Harvested plants were dried at room temperature in shadow. Dried samples were ground separately through a 40-mesh screen and stored at 5 °C until used for bioassay. *Chenopodium album* L. seeds were collected in Erciyes University experimental fields Kayseri, Turkey in September 2013. Seeds from different plants were pooled and put in the storage at 5 °C.

### 2.1. Isolation of Essential Oil

The dried plant samples (100 g) were subjected to hydro distillation (plant material in boiling water) using a Clevenger-type apparatus for 3h.

### 2.2. Bioassay Test for Dose–response studies

Various (0, 2, 4, 8, 16 and 32 µL) doses were used in bioassay test. The effects of the essential oils were determined on the seed germination, shoot and root growth of *Chenopodium album*.

Before bioassays, seeds were surface sterilized in 1:10 (v/v) dilution of commercial hypochlorite bleach for 10 min and rinsed several times with distilled water. Seeds were placed on moistened paper towels for 2 h. Thirty *C. album* seeds were placed on filter paper in sterilized 9 cm dia Petri dishes. In each Petri dishes moistened with 7.5 mL of distilled water. Small filter paper were glued to the lid of the petri dishes and different concentrations of essential oil (0, 2, 4, 8, 16 and 32 µL) added with pipette. Petri dishes were covered immediately by using parafilm. All Petri dishes were placed in a lighted growth chamber (16 h light 8 h dark) at 25 °C. Percent germination was determined and seedling shoots and root lengths were measured after 21<sup>st</sup> days of treatments. Four Petri dishes were maintained as replicates for each treatment in a randomized block design.

Percent inhibition was calculated as :

$$\frac{[(\text{Control-Aqueous extracts})/\text{Control}]}{1} \times 100 \quad [1]$$

### 2.3. Statistical Analysis

The laboratory bioassays were done with four replications using a randomized design. Data from experiments mean values were separated based on the least significant difference (LSD) at 0.05 probability level. Analysis of variance was done for all data using a general linear model. A preliminary analysis of dose-response curves within medicinal plants showed that the data were best described with log-logistic curve [20]. Relative inhibition of germination data were analyzed using the four parameter log-logistic model where the D term was fixed at 100 [21]:

$$[ y = D \times \exp - \exp( b \times \log( x ) - \log( e ) ) ] \quad [2]$$

Where, Y: Response (e.g., seed germination *C. album*), D : Upper limit, b : Slope of the regression line, and x : Doses of extracts. EC50 : Dose providing 50% response (50% reduction in seed germination, also known as the “inflection point”, I50, or EC50) were obtained from formula [2]. The analyses of dose–response curves were conducted using R and drc software packages as previously described [20,22].

## 3. RESULT AND DISCATION

### 3.1. Germination

The extract concentrations from different plant species had variable inhibitory effects on seed germination of *C. album*. The maximum inhibition (100 %) rates on germination were obtained from the highest essential oils doses (Figure 1). Total germination inhibition on the seeds of *C. album* ranged from 7.75 % to 100 %, depending on the essential oils doses.

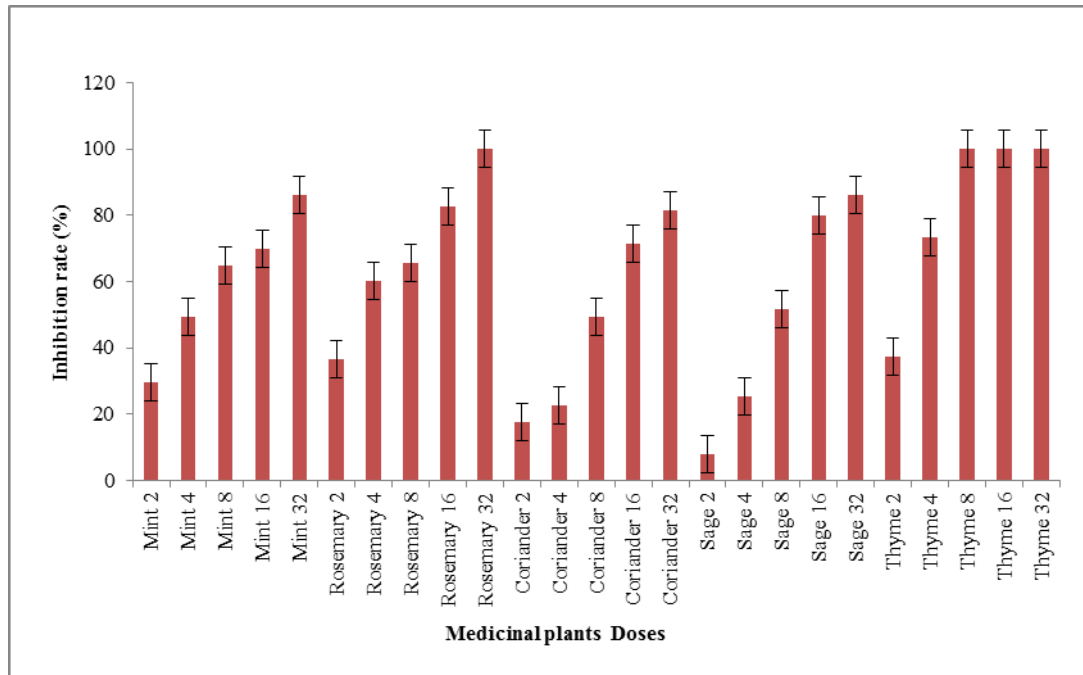

Figure 1. The inhibitory effect of different doses of medicinal plants essential oils on germination of *C. album*. Bars represent standard error of means ( $P < 0,05$ )

The phytotoxicity of essential oils was increased significantly with the doses of essential oils. The essential oil from thyme at the highest doses (8, 16 and 32 μL) drastically inhibited the germination > 100% (Figure 2). The lowest doses (2 μL) effect on *C. album* germination was 37.5 %. The EC10, EC50, and EC90 were 0.99, 2.53 and 6.43 2 μL, respectively (Table 1). Dose-response curves were parallel but differed significantly in EC10, and EC50 values. This parallelism is an indicator of similarity in the mode of action of an active compound. Similar trends in germination were observed for other medicinal plant essential oils. The rosemary essential oils at 2 μL inhibit the *C. album* germination 36.5 %, the inhibition increased from 82.5 % to 100 % as the doses increased from 16 to 32 μL (Figure 2). The EC10, EC50, and EC90 of rosemary essential oils were 0.26, 11.63 and 508.88 μL, respectively (Table 1).

### Dose Response Curves

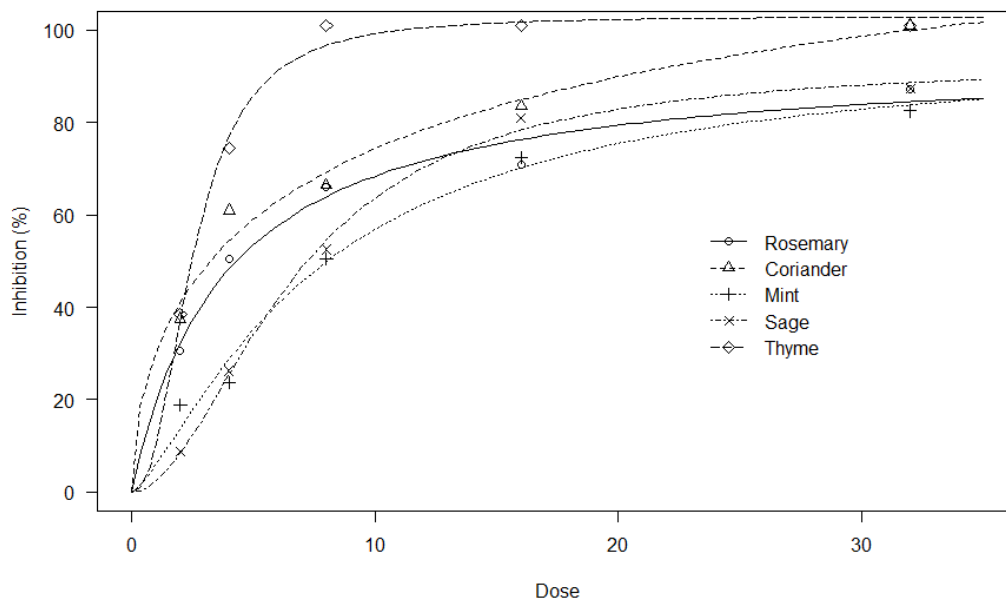

Figure 2. Effect of different medicinal plants essential oils on germination of *C. album*. The lines were fitted accounting to Equation 2.

Table 1. Log-logistic regression parameters and effective concentration (EC10, EC50, and EC90) of different medicinal plants extracts on inhibition of seed germination of *C. album*.

Extracts	Log-logistic parameters			Effective concentration (EC) ( $\mu\text{L}$ )		
	d	e	b	EC <sub>10</sub>	EC <sub>50</sub>	EC <sub>90</sub>
Mint	94.65	3.84	-1.00	0.42±0.31	3.84±2.04	34.56±56.10
Rosemary	155.48	11.63	-0.58	0.26±0.15	11.63±30.79	508.88±2605
Coriander	96.08	7.56	-1.33	1.45±0.48	7.56±2.77	39.23±34.15
Sage	93.03	6.67	-1.91	2.11±0.51	6.67±1.16	21.01±8.81
Thyme	103.09	2.53	-2.35	0.99±0.23	2.53±0.25	6.43±1.61

Regression parameters were estimated using Equation 2.

### 3.2. Shoot Length

The essential oils significantly reduced the *C. album* shoot length (Figure 3). The highest doses of essential oils showed the highest decrease rate in shoot length. While essential oil of the sage showed minimum suppressive effect; the essential oils of the thyme showed maximum suppressive effect on the shoot length of *C. album*. The EC<sub>10</sub>, EC<sub>50</sub>, and EC<sub>90</sub> of thyme extracts were 0.65, 2.47 and 9.34  $\mu\text{L}$ , respectively (Table 2).

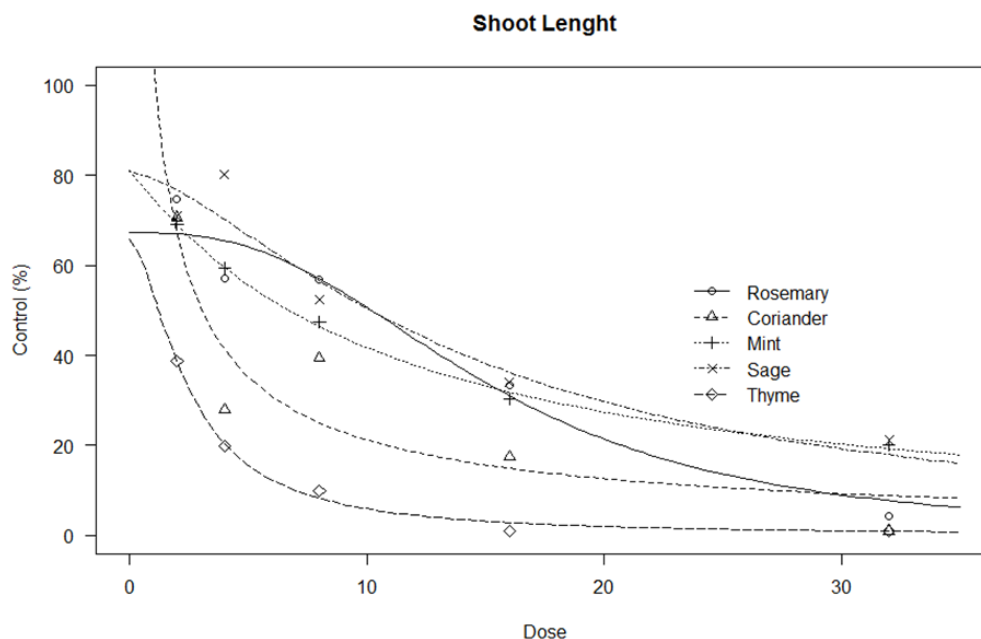

Figure 3. Effect of different plants essential oils on shoot length of *C. album*. The lines were fitted accounting to Equation 2.

Table 2. Log-logistic regression parameters and effective concentration (EC10, EC50, and EC90) of different medicinal plants essential oils on shoot length of *C. album*.

Extracts	Log-logistic parameters			Effective concentration (EC) ( $\mu\text{L}$ )		
	d	e	b	EC <sub>10</sub>	EC <sub>50</sub>	EC <sub>90</sub>
Mint	67.28	15.09	2.71	6.71±2.94	15.09±2.33	33.91±9.03
Rosemary	565.11	0.14	0.77	0.008±0.03	0.14±0.49	2.57±7.55
Coriander	81.04	10.56	1.05	1.30±1.95	10.56±6.45	85.46±43.33
Sage	80.71	13.99	1.52	3.29±1.73	13.99±2.86	59.36±20.55
Thyme	65.73	2.47	1.65	0.65±1.78	2.47±4.19	9.34±7.28

Regression parameters were estimated using Equation 2.

### 3.3. Root Length

The effects of plant aqueous extracts on root length were similar to shoot length. Plant extracts also significantly reduced the *C. album* root length and the highest doses of essential oils showed the highest reduction on root length (Figure 4). Maximum reduction of root length was observed from thyme essential oil applications. The EC10, EC50, and EC90 of thyme essential oil were 0.94, 3.21 and 10.95  $\mu$ L, respectively (Table 3).

Table 3. Log-logistic regression parameters and effective concentration (EC10, EC50, and EC90) of different medicinal plants extracts on root length of *C. album*.

Extracts	Log-logistic parameters			Effective concentration (EC) ( $\mu$ L)		
	d	e	b	EC <sub>10</sub>	EC <sub>50</sub>	EC <sub>90</sub>
Mint	86.23	1.84	0.71	0.08 $\pm$ 0.53	1.84 $\pm$ 7.61	41.13 $\pm$ 79.84
Rosemary	728.37	0.11	0.85	0.008 $\pm$ 0.03	0.11 $\pm$ 0.31	1.41 $\pm$ 3.71
Coriander	44.21	21.61	1.36	4.32 $\pm$ 4.57	21.61 $\pm$ 6.92	107.86 $\pm$ 87.35
Sage	53.96	16.73	1.10	2.306 $\pm$ 2.41	16.72 $\pm$ 6.15	121.34 $\pm$ 84.76
Thyme	35.89	3.21	1.79	0.94 $\pm$ 2.29	3.21 $\pm$ 4.34	10.95 $\pm$ 6.20

Regression parameters were estimated using Equation 2.

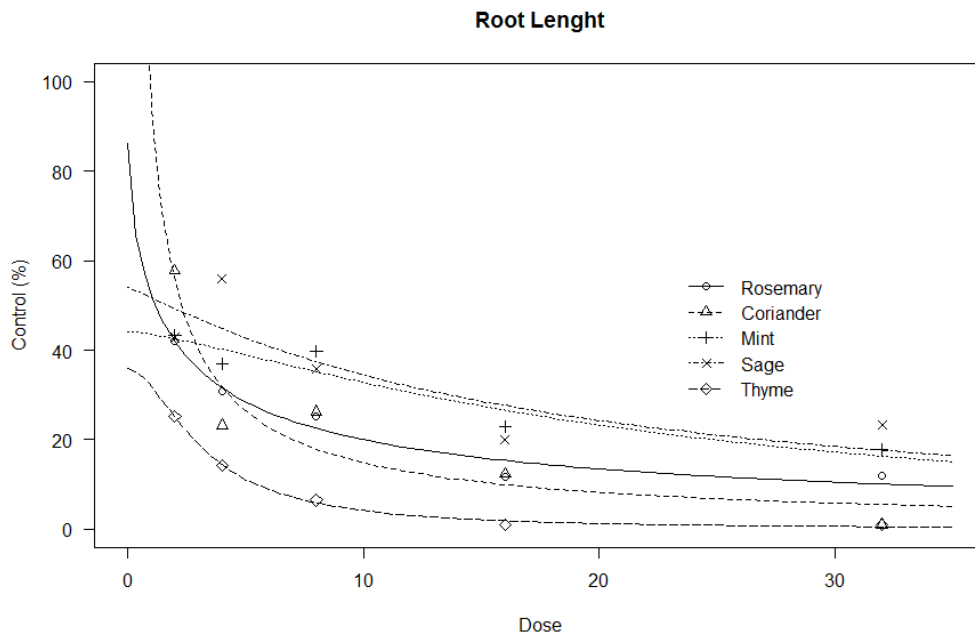

Figure 5. Effect of different medicinal plants essential oil on root length of *C. album*. The lines were fitted accounting to Equation 2.

Certain plant species or their residues selectively inhibit development of particular species. This differential sensitivity observed in field, green house and laboratory experiments with residues, extracts and purified allelochemicals [23,24].

The results obtained the present research agree with most of the previous results obtained by many other researchers, which emphasized that essential oils of many plants inhibit germination of many other plants [25, 26]. Also results from different parts and different allopathic plants proved the inhibition effect on seed germination of some pasture plants [27, 28, 29]. These findings also confirm that extracts of many plant species including medicinal herbs contain allelochemicals which have been reported to affect enzyme responsible for plant hormone synthesis, in addition to inhibition of nutrient and ion absorption by affecting plasma membrane permeability.

### 4. CONCLUSIONS

Extracts of mint, thyme, sage, rosemary and coriander inhibited seed germination, seedling and root growth of *C. album* are investigated in proportion related to the concentration of the extracts. A great deal of success on controlling *C. album* could be achieved only by the application of high extract concentration tested species. The results of the current study showed that total germination inhibition in *C. album* ranged between 7.75 to 100 %, depending on the essential oils doses. The maximum germination inhibition rate (100 %) was obtained from the highest essential oils doses for all test species. For final decision

about the allelopathic potential of essential oils, future studies are needed to evaluate allelopathic activities of the tested species under field conditions.

## REFERENCES

- [1] H. Mennan, E. Kaya-Altop, M. Ngouajio, M.Sahin and D. Isik. "Allelopathic potentials of rice (*Oryza sativa* L.) cultivars' leaves, straw and hull extracts on seed germination of barnyardgrass (*Echinochloa crus-galli* L.)" *Allelopathy J.* vol. 28, pp. 167–178, 2011
- [2] Z. Ozer, Niçin Yabancı Ot Bilimi Türkiye L. Herboloji Kongresi Bildirileri. 1-7 s. Adana 1993
- [3] H. Mennan, M. Ngouajio, M. Sahin, D. Isik and E. Kaya-Altop, "Quantification of momilactone B in rice hulls and the phytotoxic potential of rice extracts on the seed germination of *Alisma plantago-aquatica*". *Weed Biology and Management* vol.12, pp. 29–39, 2012.
- [4] H. Shibayama, "Weeds and weed management in rice production in Japan". *Weed Biology and Management*, vol.1, pp. 53-60, 2001.
- [5] H. Om, S.D. Dhiman, S. Kumar, H. Kumar, "Allelopathic response of *Phalaris minor* to crop and weed plants in rice–wheat system. *Crop Protection*, vol. 21, pp. 699–705, 2002.
- [6] P. Rajput, and P. B.Rao, "Weed Management through Bio-Herbicidal Activity of Rice Straw for Mitigating Herbicide Dependency". *American-Eurasian J. Agric. & Environ. Sci.*, vol.13 (11), pp. 1533-1540, 2013.
- [7] T.D. Xuan, S. Tawata, T.D. Khanh, I.M.Chung, "Biological control of weeds and plant pathogens in paddy rice by exploiting plant allelopathy". *Crop Prot* vol. 24, pp. 197–206, 2005.
- [8] S. Duke, O., Dayan, F. E., Rimando, A. M., Shrader, K., Aliotta, G., Oliva, A., and Romagni, J. G. "Chemicals from nature for weed management". *Weed Sci.* vol. 50, pp. 138–151, 2002.
- [9] A. R. Putnam, "Allelochemicals from plants as herbicides". *Weed Tech.* vol. 2, pp. 510–518, 1988.
- [10] Inderjit, "Plant phenolics in allelopathy". *Bot. Rev.* vol. 62, pp. 186–202, 1996.
- [11] F.A. Einhellig, "Interaction involving allelopathy in cropping system". *Agron. J.* vol. 88, pp. 886–893, 1996
- [12] T. A. El-Shahawy, "Rice straw as an allelopathic agent for controlling weeds". Seventeenth Australasian Weeds Conference s. 143-146. 2010.
- [13] F. A. Macias, J. M. G. Molinillo, J. C. G. Galindo, R. M. Varela, A. M. Simonet and D. Castellano, "The use of allelopathic studies in the search for natural herbicides". *J. Crop Prod.* Vol. 4 (2) pp. 237-255, 2001.
- [14] L.A. Weston, S.O. Duke, 2003. Weed and Crop Allelopathy. *Critical Reviews in Plant Sciences*, vol. 22(3&4), pp. 367–389, 2003.
- [15] M.B. Isman, "Plant essential oils for pest and disease management". *Crop Protect.* Vol. 19, pp. 603–608, 2000.
- [16] D.R. Batish, H.P. Singh, R.K. Kohli, S. Kaur, "Eucalyptus essential oil as natural pesticide". *For. Ecol. Manage.* Vol. 256, pp. 166–174. 2008.
- [17] J.N. Barney, A.G. Hay, L.A. Weston, "Isolation and characterisation of allelopathic volatiles from mugwort (*Artemisia vulgaris*)". *J. Chem. Ecol.* Vol. 31, pp. 247–265, 2005.
- [18] F.E. Dayan, C.L. Cantrell and S.O. Duke, "Natural products in crop protection". *Bioorg. Med. Chem.* Vol. 17, pp. 4022–4034, 2009.
- [19] G. Ankita, and M. Chabbi, "Effect Of Allelopathic Leaf Extract Of Some Selected Weed Flora Of Ajmer District On Seed Germination Of *Triticum Aestivum* L. Science Research Reporter 2(3):311-315, Oct. 2012. 2012
- [20] C. Ritz, and J.C. Streibig, Bioassay Analysis Using R. *Journal of Statistical Software* 12: 1-22. 2005
- [21] S.S. Seefeldt, J.E.Jensen, E.P. Fuerst, "Log-logistic analysis of herbicide dose–response relationships". *Weed Technol.* Vol. 9, pp. 218–227, 1995.
- [22] S.Z. Knezevic, J.C. Streibig and C. Ritz, "Utilizing R software package for dose-response studies: the concept and data analysis". *Weed Technology* vol. 21, pp. 840–848, 2007.
- [23] L. Djurdjevic, A. Dinic, P. Pavlovic, M. Mitrovic, M. Karadzic, V. Tesevic, "Allelopathic potential of *Allium ursinum* L., *Biochemical Systematic and Ecology*, vol. 32 (6), pp. 533-544, 2004.
- [24] A.W. Leslie, "Utilization of allelopathy for weed management in agro ecosystems", *Agronomy Journal*, vol. 88, pp. 860-866, 1996.
- [25] M. Noor, U. Salam and M.A. Khan, "Allelopathic effects of *Prosopis juliflor* Swartz", *Journal of Arid Environments*, vol. 31, pp. 83-90, 1995.
- [26] D. Von Rencsse, Experimentelle Untersuchungen un Knozeptionelle Uberlegungen fur Einscreening- Verfahren des Alleopathischen Potentials Ausgewahller Baumarten (*Juglans spp Euclayptus comaldulensis*) unpublished, Ph.D. Thesis, University of Kassel Germiany (1997).
- [27] A. Johnston, "Some factors effecting germination, emergence and early growth of three range grasses", *Can. J. Plant Sci.*, vol. 41, pp. 59-70, 1961.
- [28] U.G. Bokhari, "Allelopathy among prairie grasses and its possible ecological significance", *Ann. Bot.*, vol. 42, pp. 127-136, 1978.
- [29] G.B. Williamson, N.H. Fischer, D.R. Richardson and A. De La Pena, "Chemical inhibition of fire-prone grasses by fire-sensitive shrub *Conradia canescens*", *J. Chem. Ecol.*, vol. 15, pp. 1567-1577, 1989.

# Determination of Weed Species in Garlic (*Allium sativum* L.) Fields in Taşköprü County in Kastamonu Province in Turkey

Dogan Isik<sup>1</sup>

---

## Abstract

Turkey is the 7 ranks among the garlic produced countries with the 4% share of production. Kastamonu, with a share of approximately 14% can be considered the most important province in Turkey in terms of cultivation. Almost all of garlic produced in Kastamonu (about 90%) are grown in the Taşköprü. According to the data in 2008 made of total garlic cultivation was 18500 hectares, total garlic production was 16,650 tons and the average yield of garlic was 9000kg/ha in Taşköprü. Purpose to determine the weed species in garlic fields in Taşköprü County in Kastamonu province 23 surveys were done at 2010 and the coordinates of the surveys fields were collected for making weed map. The first 10 species determined in terms of frequency were *Convolvulus arvensis* L. (% 91.30), *Chenopodium album* L. (% 82.61), *Medicago* spp. (% 69.56), *Amaranthus retroflexus* L. (% 65.21), *Echinochloa crus galli* (L.) P.Beauv ( % 60.86), *Sinapis arvensis* L.(%56.52), *Sonchus arvensis* L. (% 56.52), *Cirsium arvense* L. (% 52.17), *Polygonum aviculare* L.(% 47.83), *Galium aparine* L.(% 30.43).

**Keywords:** Garlic, weed, survey, Taşköprü - Kastamonu

---

## 1.INTRODUCTION

Garlic (*Allium sativum* L.) belonging to family amaryllidaceae, is the second most widely cultivated crop in the family after onion [1]. It consists of an underground bulb and above ground vegetative part, which also comprises of a flat as well as slender leaves. It has fibrous root system and is frost hardy. Garlic widely consumed for its culinary and medical benefits. Currently, garlic has been cultivated worldwide although its center of origin is presumed to be Central Asia [2].

Kastamonu garlic is the most widely grown garlic clone in Turkey due to its high soluble solid content, strong flavor, and long storage capability. A recent study showed that it contains 17.2% crude protein, 0.14% essential oil, and 1779 mcg/kg dimethyl sulphite [3]. Another important characteristic of Kastamonu garlic is its tightly appressed pseudostem (leaf bases wrapped around the neck of a bulb) and this characteristic makes it an ideal variety for making garlic braids. It has attractive white rose blushed cloves which are surrounded by a white outer skin. This garlic clone rarely grows a visible flower stalk, therefore, it can be considered as a non-bolting garlic type. Kastamonu garlic is very well adapted to Taskopru district in Kastamonu province which is located in the north western part of Turkey. Since Kastamonu province produces about 17% of Turkey's garlic production mainly using this variety, it is called 'Kastamonu garlic' or 'Taskopru garlic' [4]. Kastamonu has a temperate climate in Black Sea coastal regions and steppe climate in inland regions, receiving most of its precipitation during spring or winter. Soils are medium calcareous, mostly clay loam in texture, and of slightly alkaline pH in Taskopru district where garlic production is concentrated [5]. The high quality features of Kastamonu garlic are likely due to the interaction between its genotype and the environment where it has been cultivated.

Garlic production effected a number of factors but the main limiting factor is the weed infestation that competes for nutrients, soil, moisture, space and light considerably reducing the yield, quality and value through increased production and harvesting costs [6]. The garlic is closely planted crop with very small canopy. Due to smaller leaf size it cannot compete with the weeds. Their competition with the plants starts at very early growth stage because immediately after planting the cloves, the weed emergence occurs that competes with the tender seedlings. As in many crops, weeds cause certain yield reduction in garlic owing to slow emergence, low initial growth rate, long vegetative period and low competitive ability. For this reason, onion requires absolute early weed control.

This study was conducted to determine the prevalence and frequency of troublesome weed species in the garlic fields in Taşköprü County in Kastamonu Province in Turkey.

## 2.MATERIALS AND METHODS

Survey studies were conducted in 2010 to determine the problematic weed species in garlic production fields in Taşköprü County in Kastamonu Province of Turkey. In total 23 fields were surveyed in Taşköprü county in Kastamonu provinces where garlic crop is widely cultivated. The fields were randomly selected and sampling procedure was made depending on field size. The number of frames (1 m<sup>2</sup>) thrown in a field varied depending on field size; 5 times for 1-5 da-1, 8 times for 5-10 da-1, 16 times for 10-15 da-1, 20 times for >15 da-1. Weed species in each frame were recorded and counted. In order to eliminate the influence of field edge on survey sampling was made inside of the fields. In addition to that frequency and density of each

---

<sup>1</sup>Corresponding author: Erciyes University Faculty of Agriculture, Department of Plant Protection Kayseri Turkey. [dogani@erciyes.edu.tr](mailto:dogani@erciyes.edu.tr)



weed species were calculated according to Odum [7]. Additionally, individuals outside the quadrates were recorded [8]. Unknown species in the fields were collected according to technical requirements, numbered, pressed and taken to laboratory for identification. Species identification of the weeds determined in the region was mainly accomplished according to Davis [9]. The formulas used in the calculations were given below.

$$\text{Intensity (plant m-2)} = Y / n$$

$$\text{Incidence (\%)} = (M / n) \times 100$$

Y = Number of individuals of a species within the quadrate.

M = Number of quadrates a plant species occurred.

n = Total number of quadrates thrown.

### 3.RESULT AND DISCATION

As a result of survey, 48 different species of 24 families were determined, of which one was fern (pteridophyta), one was parasitic weeds, 9 were monocotyledonous and 37 were dicotyledonous. The most common families in the surveyed rice fields were *Poaceae* (7 species), *Asteraceae* (7 species) and *Fabaceae* (4 species). The rest 21 families were represented by 1-2 numbers of species.

The first 10 species determined in terms of frequency were *Convolvulus arvensis* L. (% 91.30), *Chenopodium album* L. (% 82.61), *Medicago* spp. (% 69.56), *Amaranthus retroflexus* L. (% 65.21), *Echinochloa crus galli* (L.) P.Beauv ( % 60.86), *Sinapis arvensis* L.(%56.52), *Sonchus arvensis* L. (% 56.52), *Cirsium arvense* L. (% 52.17), *Polygonum aviculare* L.(% 47.83), *Galium aparine* L.(% 30.43).

The first 10 species determined survey area in terms of frequency were *Convolvulus arvensis* L. (8.77 plant/m<sup>2</sup>), *Chenopodium album* L. (7.30 plant/m<sup>2</sup>), *Amaranthus retroflexus* L. ( 4.52 plant/m<sup>2</sup>), *Sinapis arvensis* L. (3.78 plant/m<sup>2</sup>), *Polygonum aviculare* L. (2.78 plant/m<sup>2</sup>), *Sonchus arvensis* L. (2.61 plant/m<sup>2</sup>), *Echinochloa crus galli* (L.) P.Beauv (2.52 plant/m<sup>2</sup>), *Medicago* spp. (2.21 plant/m<sup>2</sup>), *Cirsium arvense* (L.) Scop. (1.43 plant/m<sup>2</sup>) and *Xanthium strumarium* L. (1.13 plant/m<sup>2</sup>).

Density and composition of weed floras are strongly affected by crop production systems and agricultural practices. The use of herbicides with similar modes of action in this area has greatly altered the density of some species [10]. Fertilizing has a great effect on the composition of weed flora [11]. Density and frequency of weed species can be raised as a result of nitrogen fertilization, which directly, stimulate germination and reproduction. *Cuscuta* spp. and *E. crus-galli* could be more problems in future after began irrigation since 1978. Parker [12] indicated that these species could be spread by irrigation.

Other main factors changing in weed flora were rotation and contaminated crop seeds in this area. Garlic was mainly rotated with wheat in this region. Wheat seeds were generally contaminated with the seeds of *B. radians*, *G. aparine* and *Avena* spp. These species germinate in both autumn and spring in this region. Therefore, these species occur in early stage of onion and cause important yield losses [13].

It is not possible to distinguish single factor from another in floral changes. Also environmental factors should be taken into consideration in composition of weed species as well as agricultural practices.

Table 1. Frequency and density of the weed species in garlic fields in Taşköprüü county of Kastamonu Province in Turkey

Latin Name	Frequency (%)	Density (plant/m <sup>2</sup> )
<i>Convolvulus arvensis</i> L.	91.30	8.77
<i>Chenopodium album</i> L.	82.61	7.30
<i>Medicago</i> spp.	69.56	2.21
<i>Amaranthus retroflexus</i> L.	65.21	4.52
<i>Echinochloa crus-galli</i> P.B.	60.86	2.52
<i>Sinapis arvensis</i> L.	56.52	3.78
<i>Sonchus arvensis</i> L.	56.52	2.61
<i>Cirsium arvense</i> (L.) Scop	52.17	1.43
<i>Polygonum aviculare</i> L.	47.83	2.78
<i>Solanum nigrum</i> L.	34.78	0.87
<i>Avena</i> spp.	30.43	0.78
<i>Galium aparine</i> L.	30.43	0.52
<i>Matricaria chamomilla</i> L.	26.09	0.34
<i>Equisetum arvense</i> L.	17.39	0.26
<i>Lamium purpureum</i> L.	17.39	0.36
<i>Melilotus officinalis</i> (L.) Desr.	17.39	1.08
<i>Ranunculus repens</i> L.	17.39	0.26
<i>Rumex</i> spp.	17.39	0.39
<i>Xanthium strumarium</i> L.	17.39	1.13
<i>Adonis</i> spp.	13.04	0.04
<i>Alopecurus myosuroides</i>	13.04	0.08
HUDSON		
<i>Euphorbia</i> spp	13.04	0.13
<i>Setaria</i> spp	13.04	0.13
<i>Stellaria media</i>	13.04	0.08
<i>Vicia</i> spp.	13.04	0
<i>Bromus</i> spp.	8.70	0
<i>Cardaria draba</i> (L.) DESV	8.70	0.04
<i>Carex divisa</i>	8.70	0.04
<i>Carex</i> spp.	8.70	0
<i>Eryngium</i> spp	8.70	0
<i>Malva neglecta</i> WALLR.	8.70	0.04
<i>Plantago major</i> L.	8.70	0.08
<i>Tribulus terrestris</i> L.	8.70	0.04
<i>Xanthium spinosum</i> L.	8.70	0.13
<i>Bifora radians</i> Bieb.	4.34	0
<i>Cuscuta</i> spp	4.34	0
<i>Datura stromonium</i>	4.34	0
<i>Elymus repens</i> (L.) GOULD	4.34	0
<i>Heliotropium europaeum</i> L.	4.34	0.04
<i>Hibiscus trionum</i>	4.34	0
<i>Lactuca serriola</i> L.	4.34	0.04
<i>Lithospermum arvense</i>	4.34	0
<i>Lolium</i> spp.	4.34	0
<i>Mercurialis annua</i>	4.34	0.08
<i>Poa annua</i> L.	4.34	0.13
<i>Portulaca oleraceae</i> L.	4.34	0.43
<i>Trifolium</i> spp.	4.34	0.74

#### 4. CONCLUSIONS

According to the results, 48 different species of 24 families were determined, of which one was fern (pteridophyta), one was parasitic weeds, 9 were monocotyledonous and 37 were dicotyledonous. Most important weed species were *Convolvulus arvensis* L., *Chenopodium album* L., *Medicago* spp., *Amaranthus retroflexus* L., *Echinochloa crus galli* (L.) P.Beauv, *Sinapis arvensis* L., *Sonchus arvensis* L., *Cirsium arvense* L., *Polygonum aviculare* L. and *Galium aparine* L. Knowing the weed species in garlic fields and their density in order to take control of weed species is important. Due to the continuously changing climate, rapid changes are being observed in weedy plants' distribution and abundance. The dramatic changes in temperature and CO<sub>2</sub> are predicted to heavily infect the density of weedy plants. In order to keep the weeds under control in changing climate scenario, knowing their density and prevalence is of key importance. The changing climate can equally affect the weed communities in rice fields. As a result of the ever increasing world population, demand for food and quality is rising. Therefore, to maintain the quality of the garlic; weeds problem must be sorted out on priority basis. The weed scientists must determine the important weeds for different crops particularly garlic in the above addressed region and devise effective management strategies.

#### REFERENCES

- [1] A. Takhtajan, Diversity and Classification of Flowering Plants. Columbia University Press, New York, 1997.
- [2] J. Hong Chong, T. Etoh, "Fertile clones of garlic (*Allium sativum* L.) abundant around the Tien Shan Mountains. *Breeding Sci.* 46, 349–353, 1996.
- [3] H. Haciseferogullari, M. Ozcan, F. Demir, and S. Calisir, "Some nutritional and technological properties of garlic (*Allium sativum* L.)," *J. Food Eng.* Vol. 68, pp. 463–469, 2005.
- [4] SIS, Agricultural Structure. State Institute of Statistics Prime Ministry, Republic of Turkey, 1998.
- [5] S. Taban, Y. Cikili, F. Kebeci, N. Taban, S.M. Sezer, Evaluation of potential nutritional problem and fertility status of the garlic grown soils of Taskopru Region (in Turkish with English abstract). *Ankara Universitesi Ziraat Fakültesi Tarım Bilimleri Dergisi* vol.,10, pp. 297–304, 2004.
- [6] F. Hussain, "Biochemical inhibition (allelopathy) a less understood ecological factor in agroecosystems". *Progressive*
- [7] *Farming*, vol. 3, pp. 33-37, 1983.
- [8] E.P. Odum, Fundamentals of ecology. W.B. Saunders Company, Philadelphia, p. 574. 1971.
- [9] E. Uluğ, İ. Kadioğlu, İ. Uremiş, Türkiye'nin Yabancı Otları ve Bazı Özellikleri. T.C. Tarım ve Koy İşleri Bakanlığı, Zirai Mücadele Araştırma Enstitüsü Mud., Yayın, Adana, No 78. 1993.
- [10] P.H. Davis, Flora of Turkey and the East Aegean Island. At the University Press. Edinburg, Vol. 1-11, 1965-1988.
- [11] J.C. Streibig and C. Andreassen, "Crop management affects the community dynamics of weeds". *BCPC, Weeds*, pp 487-493, 1993.
- [12] N.T. Andersson P. Milberg, "Weed flora and the relative importance of site, crop, crop rotation and nitrogen". *Weed Science*, vol. 46 pp. 30-38, 1998.
- [13] C. Parker, Prediction of new weed problems especially in the developing world. Proc. 18 th Symp. Br. Ecol. Soc., Blackwell Scientific, Bangor Wales, 249, 1977.
- [14] H. Mennan and D. Işık, "Invasive Weed Species in Onion Production Systems During The Last 25 Years in Amasya-Turkey". *Pakistan Journal of Botany*, vol. 35 (2), pp. 155-160, 2003.

# The Impact of Macroeconomic and Bank Specific Factors on Albanian Non-Performing Loans

*Klejda Gabeshi<sup>1</sup>*

---

## *Abstract*

*Credit risk measurement of the banking system, the dominant component of the financial system of a country, is an important aspect where the interest of academics, economic agents and other professionals has been considerably increased, especially following the global financial crisis. In the last decade, non-performing loans have been in the spotlight almost all over the world, since their large and uncontrolled increase would lead to the eventual bankruptcy of the banking system as a whole. Analysis of the factors affecting credit risk for the banking system is an important analysis and can be seen as the key for credit risk management. This starts by the identification of direct and indirect determinants which exhibit an impact on credit risk, followed by the assessment of the impact (negative or positive impact). The main objective of this paper is to analyse the link between the macroeconomic developments and the banking credit risk in Albania, recently affected by unfavorable economic and financial conditions and to which, on this matter, the literature has not given a particular attention yet. The econometric model used is that of multiple linear regression where as the dependent variable is obtained the indicator of non-performing loans of the Albanian banking system and as independent variables are chosen a number of macroeconomic indicators and indicators of assets and liabilities of the system itself. Employing data approaches to this country over the period 2005-2014, I conclude that the banking credit risk is significantly affected by the macroeconomic environment: the credit risk increases when GDP growth, credit growth rate and the share price indices decrease and rises when the interest rate and loan to deposit ratio increase. Moreover, it is also positively affected by an appreciation of the real exchange rate.*

**Keywords:** *Banking System, Credit Risk, Macroeconomic Determinants, Non-Performing Loans*

---

## **1. INTRODUCTION**

*“It is well enough that people of the nation do not understand our banking and monetary system, for if they did, I believe there would be a revolution before tomorrow morning!”* Henry Ford

The purpose of this article is to provide a comprehensive statement of theoretical and applied problems in the Albanian banking system. Regardless of Ford’s fear, I don’t think that reading this paper will cause a revolution, but at least, I hope to provide an enjoyable and interesting image of banking activity.

It is not necessary to be a specialist in the field of banks, in order to understand the importance of the banking system in our everyday life. We participate almost daily in activities in which this sector plays an important role. The mission of a performant banking system is to allocate the capital exclusively in profitable projects. To succeed, banks must be able to determine which projects are profitable and which are not. If they do this correctly, then the economy has all the chances to work properly.

In the Albanian banking system, exposure to credit risk is the main risk from which the system is exposed to. Loans compose the majority of the banking system assets. Furthermore, in the last years, loan portfolio quality has been significantly deteriorated, which can be easily understood from the increase in non-performing loans. The main objective of this paper is to analyse the link between the macroeconomic developments and the banking credit risk in Albania, starting by the identification of direct and indirect determinants which exhibit an impact on credit risk. The econometric model used is that of multiple linear regression where as the dependent variable is obtained the indicator of non-performing loans of the Albanian banking system and as independent variables are chosen a number of macroeconomic indicators and indicators of assets and liabilities of the system itself. The method applied is the method of least squares and the model is tested in advance via EViews software for basic assumptions of the method.

## **2. MATERIALS AND METHODS**

### **2.1 Literature Review**

In the last decade, non-performing loans have been in the spotlight almost all over the world, since their large and uncontrolled increase would lead to the eventual bankruptcy of the banking system as a whole. Many researchers confirmed that the cause for a bank bankruptcy is also the quality of assets, which is an important predictor of its insolvency. Developments in the global economy and particularly the global economic crisis are exerting a negative impact on the Albanian market and are causing the

---

<sup>1</sup>Corresponding author: Logos University, Faculty of Economics, Department of Finance and Accounting, Tirana, Albania  
[klea.gabeshi@gmail.com](mailto:klea.gabeshi@gmail.com)

contraction of the credit market. In the last years, credit growth decelerated progressively starting from the fourth quarter of 2008, from +5.02% to -1.86% in the third quarter of 2013.

According to the surveys conducted by the Bank of Albania, there are several reasons that forced commercial banks to constrain credit standards in the last five years, especially in the sector of small and medium enterprises, but also in the large enterprises sector. These reasons are also related with the increase in non-performing loans in the Albanian banking system. Firstly, this trend is related to the financial difficulties of the construction sector, processing industry and trade, repair of motor vehicles and household appliances. These sectors represent the largest share of the distribution of credit by economic sector and inevitably had a negative impact on the increase of non-performing loans. The recent published data of the World Bank, classify Albania as one of the countries with the highest level of non-performing loans among developing economies in Europe and Asia, with 18.2% of the total portfolio of loans granted at the end of 2015. In the meantime, the decrease of remittances has contributed, directly or indirectly, in the reduction of the solvency of the Albanian customers, without neglecting the large decline of the pace of economic growth in Albania, which has brought the weakening dynamism of the economy and economic operators. Finally, another reason is the outstanding liabilities of the government to private businesses for the public affairs committed. Buying financial products with high risk, strengthening banking supervision and screening of banks, taking decision based on a strong analysis of the cost-benefit, etc. are the suggestions provided by some economic experts, associated with the decrease of non-performing loans.

Table 1. Non performing bank loans in relation to total gross loans. Source [18]

NON-PERFORMING LOANS IN RELATION TO TOTAL LOANS (2010-2015)						
Country	2010	2011	2012	2013	2014	2015
Albania	14.0%	18.8%	22.5%	23.5%	22.8%	18.2%
Greece	9.1%	14.4%	23.3%	31.9%	33.8%	34.7%
Kosovo	5.8%	5.7%	7.4%	8.5%	8.3%	6.2%
Macedonia	9.0%	9.5%	10.1%	10.9%	10.8%	10.3%
Montenegro	21.0%	15.5%	17.6%	18.4%	16.8%	13.4%
Serbia	16.9%	20.0%	18.6%	21.4%	21.5%	22.3%

From the region, Greece has recorded the highest value of non-performing loans with 34.7% of the total gross loans at the end of 2015, which can be easily understood by the debt crisis this country is still facing. Serbia has registered 22.3% of total gross loans, ranking first among West Balkan countries. After these two countries, Montenegro is ranked with 13.4%, followed by Macedonia with 10.3%. Of all the countries presented, Kosovo is the only country in the region which has managed to keep the percentage of non-performing loans in the single digits, while it managed to reduce this percentage even further at the end of 2015 if compared to the two previous years.

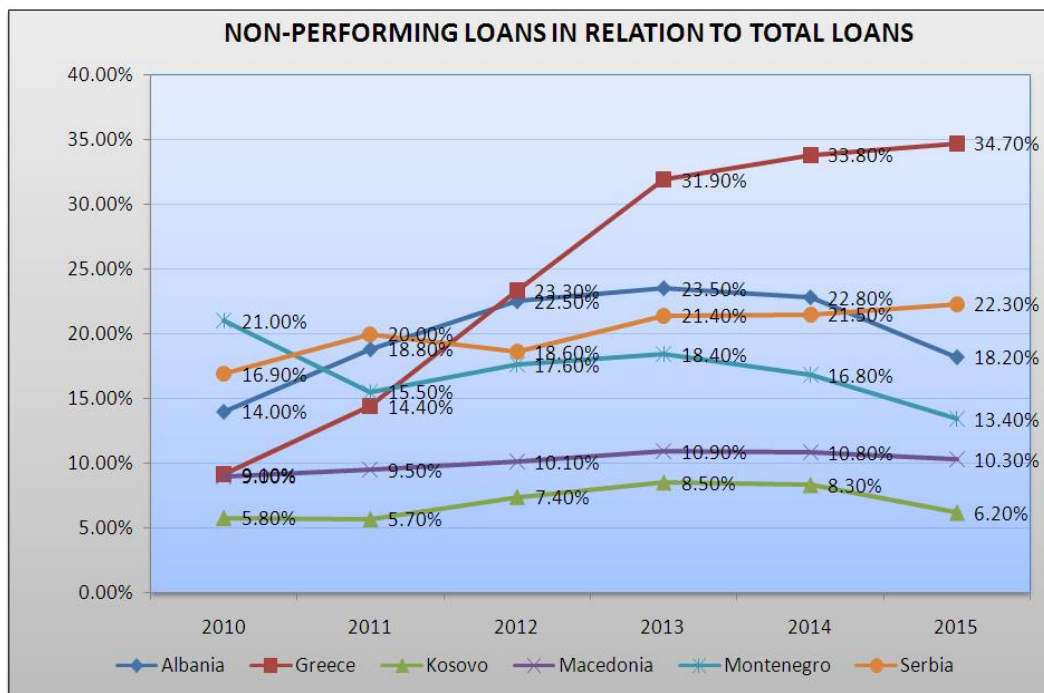

Figure 1. Non performing bank loans in relation to total gross loans.

Figure 1 shows fluctuating trends of non-performing loans percentages of countries that Albania is bordered with and Serbia. The trend of NPLs of the banking system in Albania is higher than other Western Balkan countries in 2013 and 2014, but it's seen a progress in 2015 as this percentage has decreased.

Based on a detailed literature review on loans and factors influencing their level, it's observed that most researchers distinguish two categories of factors: external factors and internal factors. The external factors are generally associated with the country's macroeconomic indicators, such as the GDP, unemployment rate, inflation rate, etc. whereas the internal factors are related to specific banking factors, such as credit growth, loan interest rate, loans to assets ratio, the quality of credit monitoring service, etc.

Keeton and Morris [14] in a study on 2470 US banks tried to understand why the level of losses on loans differs from one bank to another. Some banks have higher losses by chance, others by the weak management of the process of lending and some others have created a well-diversified portfolio, which allowed them to maintain a lower risk and facilitate lending standards. Another explanation of high losses on loans is the occurrence of banks in areas with poor economic conditions, suggesting that banks would be less vulnerable to these losses if they would lend loans to a wider geographical area. An increase in loan growth is likely to lead to higher loan losses only if the source of the faster loan growth is a shift in the supply of bank credit, related to the fact that banks become more willing to lend and they ease their credit standards [15]. As a key factor influencing the level of non-performing loans is the composition of the loan portfolio, which plays an important role as an indicator of banking risk profile. Inefficient banks, which perform a weak review and pursuit of the borrowers, will have a lower portfolio quality. Generally, the competitive environment in which banks operate can affect the level of credit risk they want to undertake [5]. Hess, Grimes and Holmes [8], analysed determinants of bank credit losses in Australasia, dividing them in two categories: macroeconomic and banking factors. Analysis was based on a comprehensive dataset retrieved from original financial reports of 32 Australasian banks (1980- 2005). Credit losses rise when the economy is weak. Larger banks provide more credit losses while less efficient banks have greater asset quality problems. The empirical results of the research made by Boudriga, Taktak and Defi [2], indicate that higher capital adequacy ratio (CAR) and prudent provisioning policy seems to reduce the level of non-performing loans and the effective way to reduce them is through strengthening the legal system and increasing transparency and democracy, rather than focusing on regulatory and supervisory issues. In their paper, Louzis, Vouldis and Metaxas [4] used dynamic panel data methods to examine the determinants of non-performing loans in the Greek banking sector. Both macroeconomic and bank specific factors have an effect on loan quality and these effects vary between different categories of loans (consumer, business and mortgage loans). The results showed that non-performing loans in the Greek banking system can be explained mainly by macroeconomic variables such as: GDP, interest rates, unemployment and management quality.

According to Bofondi and Ropele [11], the quality of lending to households and firms can be explained by a small number of macroeconomic variables, mainly related to the general state of economy, the cost of borrowing and the burden of debt. Similarly, Carlos [3] investigated the macroeconomic determinants of non-performing loans in Italy and Spain for the period from 2004 to 2012. The macroeconomic variables used were: credit growth, inflation, wage, unemployment and GDP. The results suggested that a shift in unemployment has a faster impact on non-performing loans in the Spanish economy than in the Italian economy. This variable had a positive and significant correlation for the both countries data. On the other hand, GDP variable had a positive correlation for the Italian data and a negative one for the Spanish data. Another study of Jakubik and Reininger [6], based on quarterly data of some European countries ( Bulgaria, Croatia, Czech Republic, Hungary, Poland, Romania, Russia, Slovakia and Ukraine), confirmed a negative statistically significant correlation between non-performing loans and economic growth. The study refers to the correlation between non-performing loans and the following indicators: loans deferred (lagged) (positive correlation), real GDP (negative correlation), stock index (negative correlation), loans in the private sector compared with GDP (positive correlation) and nominal exchange rate (positive correlation). In a similar study, Klein [7] evaluated the macroeconomic and bank specific determinants of non-performing loans in Central, Eastern and South Eastern Europe over 1998-2011. The author's results confirmed that the level of non-performing loans tends to increase when unemployment rises, exchange rate depreciates and inflation is high.

I<sup>1</sup> have also studied, by using a multiple regression model, the impact of macroeconomic determinants on the level of non-performing loans for Romanian banking system, over the period 2006-2011. My results showed a positive statistically significant correlation between unemployment and non-performing loans and a negative correlation of them with the interest rate.

Outside of Europe, Jordan and Tucker [1] examined the impact of non-performing loans on economic growth in The Bahamas utilizing a vector correction model. The main findings revealed that growth in macroeconomic activity tends to lead to a reduction in non-performing loans.

In the case of Albania, Mancka [10] estimated that exchange rate Euro/All and Euro/\$, as well as a variable that measures the global financial crisis are factors that affect the severity of non-performing loans. The analysis was based on data from 2002 to 2010. In another study, Shingjergji [13] analysed the impact of the macroeconomic variables on the non-performing loans level in the Albanian banking system, using quarterly data from 2005 to 2012. From the regression analysis is noticed a positive correlation between NPLs ratio and GDP growth, interest rate of four quarters lag and foreign exchange rate Euro/All. In the same year, the author [12] wrote a paper in which he analysed the relationship between the NPLs ratio and several bank specific variables in order to understand at what extent the banking variables will be able to explain the NPLs ratio. By testing the model resulted a positive correlation of the loan's level and net interest margin with NPLs ratio and a negative one between

---

<sup>1</sup> Klejda Gabeshi, *The Structure of the Romanian Banking System and Its Influence on the Prospect of Banking Products and Services*, Bachelor thesis, Bucharest 2011.

NPLs ratio and the loan to asset ratio, ROE and capital adequacy ratio (CAR). In a more recent study, Kurti [9] studied the determinants of non-performing loans in Albania during 2000-2013, with the purpose to give recommendations of what actions should be taken to reduce the level on these problematic loans. The results were in the same line with those of Shingjergji.

There are a lot of studies on these issues from different authors around the world. Despite the fact that the authors have found different ways to explain the level of non-performing loans depending on macroeconomic and banking variables, the results obtained from their studies tend to converge to these key correlations:

Table 2. Correlation between NPLs ratio and other variables

Positive Correlation with NPL	Negative Correlation with NPL
Unemployment	GDP Growth Rate
Interest Rate	Inflation
Credit Growth Rate	ROE
Fluctuating Exchange Rate	Capital Adequacy Ratio (CAR)
Loans to Assets Ratio	
The margin of intermediation	

## 2.2 Econometric Framework and Model Specification

Analysis of factors affecting the credit risk for the banking system is an important analysis and can be seen as the key for credit risk management. This starts by the identification of direct and indirect determinants which exhibit an impact on credit risk, followed by the assessment of the impact (negative or positive impact).

The econometric model used is that of multiple linear regression where as the dependent variable is obtained the indicator of non-performing loans of the Albanian banking system and as independent variables are chosen a number of macroeconomic indicators and indicators of assets and liabilities of the system itself. The method applied is the method of least squares and the model is tested in advance via EViews software for basic assumptions of the method. Different reports of the Bank of Albania [16] and published data of the Institute of Statistics [17] are used for quantitative data collection. All the independent variables, such as the dependent variable are considered for a period of ten years with quarterly data, starting from the first quarter of 2005 to the fourth quarter of 2014. This period has been considered as starting from 2005 the data for the banking system have been more complete and more accurate.

As mentioned above, the dependent variable of the econometric model is NPL, which represents the ratio of bank non-performing loans to total gross loans (%). Instead, the independent variables are classified into two groups: macroeconomic factors and bank specific factors. After an analysis of research in this field as macroeconomic factors, are selected indicators of interest to the context in which our country is. These factors are:

- ✓ *Return on Equity (ROE)*. ROE is expressed as a percentage and calculated as the ratio of net income to shareholder's equity. ROE is the amount of net income returned as a percentage of shareholders equity. Return on equity measures a corporation's profitability by revealing how much profit a company generates with the money shareholders have invested.
- ✓ *Gross Domestic Product Growth Rate (GDP)*. *Gross domestic product* is the monetary value of all the finished goods and services produced within a country's borders in a specific time period. Though *GDP* is usually calculated on an annual basis, it can be calculated on a quarterly basis as well.
- ✓ *Inflation Rate (INF), consumer prices (%)*. Inflation is the rate at which the general level of prices for goods and services is rising and, consequently, the purchasing power of currency is falling.
- ✓ *Fluctuating Exchange Rate Euro/Leke (Eur\_Lek)*. A floating exchange rate is a type of exchange rate regime in which a currency's value is allowed to fluctuate in response to foreign exchange market mechanisms.

Banking group of factors includes many indicators, but by detailed review of the literature and in the current context will be used the following banking indicators:

- ✓ *Credit Growth Rate (Cred\_Grow)*. Credit Growth refers to the growth/increase in the amount of credit that banks lend to the companies, business man, individuals, institutions, etc. either in the form of retail loans or institutional loans or any other form of loan or credit.
- ✓ *Bank Size (SIZE)*. It is an indicator that is measured by the natural logarithm of total assets, which is expected to have a positive impact on the profitability of banks, as it shows the level of banking activity in the country.
- ✓ *Loan to Deposit Ratio (LTD)*. The loan to deposit ratio is used to calculate a lending institution's ability to cover withdrawals made by its customers.

The aim of this study is to determine and analyze the relationship between the dependent variable (NPL) and independent macroeconomic and bank variables in the banking system. This study is based on establishing some hypotheses that are expected to be certified through the regression model to be used.

- Null Hypothesis ( $H_0$ ): None of the independent variables has any impact on the level of non-performing loans.
- Alternative Hypothesis ( $H_a$ ): At least one of the independent variables has an impact on the level of non-performing loans.

Theoretically it is expected an inverse relation between the level of ROE and the level of non-performing loans. An increase of the non-performing loans would lead banks to a reduction in the level of ROE. Banks have difficulty in recovering these loans and as a result it would lead to a deterioration of their performance, which ultimately will be translated into a lower ROE indicator. There is significant empirical evidence of a negative relationship between the growth in GDP and the level on non-performing loans. Indeed a strong positive growth in GDP is usually translated into an increase of the income of a country in general. Revenue growth means that both businesses and individuals have more income available, which means that now they are able to repay their loans and as a result is expected to be a decline in the level of non-performing loans. This means that strong performance in the real economy results in lower non-performing loans. Furthermore, it is expected an inverse relation between the inflation rate and the level of non-performing loans and in fact an increase in inflation would lead to a decrease in the real value of the principal remained unpaid, so the borrower will have more opportunities to pay their loan repayments, which would lead into a lower level of non-performing loans. There is also evidence in the literature of a positive association between the level of non-performing loans and real effective exchange rate. This connection is explained by the fact that if the other conditions are kept unchanged and if there is an increase of the exchange rate Euro/All for loans granted in euro, the payment of instalments will be more difficult because borrowers will pay higher instalments due to the increase in the exchange rate. Excessive lending by commercial banks is often identified as an important determinant of NPLs. We expect Credit Growth Rate to have a significant positive relationship with NPLs since the literature shows that rapid credit growth is often associated with higher non-performing loans. The empirical evidence relating to the impact of bank size on NPLs appears to be mixed. For instance, some studies report a negative association between NPLs and bank size. According to these studies, the inverse relationship means that large banks have better risk management strategies that are usually translated into more superior loan portfolios vis-à-vis their smaller counterparts. There are also studies which provide evidence of a positive association between NPL and bank size. Moreover, it is expected a strong positive relationship between NPL and the loan to deposit ratio. The supporting argument is that banks that value profitability more than the cost of higher risk (represented by a high loan to deposit ratio) are likely to incur higher levels of NPLs during periods of economic downturn.

### 3.RESULTS AND DISCUSSION

To test the level of statistical importance of the independent variables, is analysed the critical probability (P-value or Prob). If the probability is below the level of importance, which we choose to work with (1%, 5% or 10%), the null hypothesis is rejected and the coefficient is considered statistically significant. While F test measures how well the independent variables explain the dependent variable performance. Another indicator used to analyse whether the model is good or not is determined  $R^2$ . This indicator takes values from 0 to 1 and shows the percentage of variation of the dependent variable explained by the considered independent variables. Durbin Watson statistics also, must have a value between 1.8 and 2.2 in order not to have autocorrelation of errors. After running the regression analysis with the EViews program is obtained this equation:

$$NPL = -1.122033488 - 0.481702279*ROE - 0.1649856551*GDP + 0.6555248997*INF + 0.02690422082*EUR_LEK - 0.8618194031*CRED_GROW + 0.2281798887*SIZE + 0.4340209706*LTD \quad (1)$$

As seen from the above equation, an increase in INF, Eur\_Lek, SIZE and LTD, will increase the NPL ratio and an increase in ROE, GDP and CRED\_GROW will decrease the NPL ratio. The empirical results, however, reveals that Inflation Rate and GDP Rate are not important determinants of NPL in the Albanian Banking System. This result is related to the fact that during the study period inflation rate has been very stable, fluctuating within the objectives of the Bank of Albania, whereas the level of non-performing loans has increased progressively from 2008 until 2014. Hence, for more relevant results, these two independent variables will be excluded from the model and the other variables will be tested again. The final equation of the econometric model has the following form:

$$NPL = -1.067434138 - 0.4648956634*ROE + 0.03024846568*EUR_LEK - 0.9006674825*CRED_GROW + 0.2192877302*SIZE + 0.4203013116*LTD \quad (2)$$

While the output of the regression model is given in the following figure:



Dependent Variable: NPL  
Method: Least Squares  
Date: 06/04/16 Time: 19:29  
Sample: 1 40  
Included observations: 40

Variable	Coefficient	Std. Error	t-Statistic	Prob.
C	-1.067434	0.216415	-4.932344	0.0000
ROE	-0.464896	0.147689	-3.147802	0.0034
EUR_LEK	0.030248	0.028124	3.075546	0.0497
CRED_GROW	-0.900667	0.242412	-3.715438	0.0007
SIZE	0.219288	0.031155	7.038540	0.0000
LTD	0.420301	0.085048	4.941905	0.0000
R-squared	0.915826	Mean dependent var	0.122220	
Adjusted R-squared	0.903447	S.D. dependent var	0.084387	
S.E. of regression	0.026222	Akaike info criterion	-4.306991	
Sum squared resid	0.023377	Schwarz criterion	-4.053659	
Log likelihood	92.13982	F-statistic	73.98476	
Durbin-Watson stat	1.866302	Prob(F-statistic)	0.000000	

Fig 2. Output evaluation in EViews

The determination coefficient ( $R^2 = 0.9158$ ) shows that independent variables in regression explain 91.58% of the variation of the dependent variable, i.e. the level of non-performing loans. Adjusted  $R^2$  is 0.9034. About the statistical significance of the econometric model we reviewed indicated F-statistic, which has a value  $F = 73.98$  with a level of probability  $p = 0.000$ , which confirms that the model is statistically significant because of the high value of F-test and the probability is below the level of importance  $\alpha = 0.05$ . Durbin Watson statistics is equal to 1.866, which means that residuals are not correlated, pointing their independence as a completion of one of the conditions of the least squares method.

C coefficient is the intercept that represents the NPL ratio when all the independent variables are equal to zero. The other coefficients are the expected slopes of how much the NPL ratio will change, for one percent of change of each independent variable. Thus, an increase in ROE with one percent will decrease the NPL ratio with 46.49%. This result is in line with the studies conducted in this area, as an increase of the non-performing loans would lead banks to a reduction in the level of ROE. Also, the data from the Albanian Banking System show that profitability measured by ROE, has suffered a major decline especially after 2008 global financial crisis. On the other hand, an increase of the exchange rate with one percent will increase the NPL ratio with 3.02%, suggesting that the international competitiveness of the local economy is an important determinant of credit risk. This result is based on the performance of the exchange rate during the study period, noted that from 2002 to 2014 the exchange rate has increased by nearly 15%. This is a very important fact considering that in the banking system almost 60% of total credit is in euro and this affects the proliferation and accumulation of non-performing loans in this currency. Regarding the specific bank factors, growth in loans exhibits a fairly strong negative relationship with non-performing loans. An increase in Credit Growth rate with one percent will decrease the NPL ratio with 90.07%. While the literature suggest a positive correlation, my peculiar results probably reflects the conservative lending stance adopted by the Albanian commercial banks in the last years, due to their bad lending experience with the increase of non-performing loans. The variable SIZE, which represents the Bank Size, is positive, meaning that an increase of it by one percent will increase the NPL ratio with 21-93%. The major banks of Albania, even if they have greater profitability, face a higher level of non-performing loans. This evidence which is inconsistent with previous studies can mean that large banks are not necessarily more effective in screening loan customers when compared to their smaller counterparts. Finally, an increase in Loan to Deposit rate with one percent will increase the NPL ratio with 42.03%. This result for Albania is consistent with previous studies, meaning that banks with a bigger risk "appetite", are likely to face higher levels of NPLs.

#### 4.CONCLUSIONS

The increase of non-performing loans in the Albanian banking system has made many banking field researchers try to find the key factors that have brought this progressive and disturbing augmentation. Based on a detailed literature review on loans and factors influencing their level, it's observed that most researchers distinguish two categories of factors: external factors and internal factors. The external factors are generally associated with the country's macroeconomic indicators, such as GDP, unemployment rate, inflation rate, etc. whereas the internal factors are related to specific banking factors, such as credit growth, loan interest rate, loans to assets ratio, the quality of credit monitoring service, etc.

The results of the econometric model showed a direct, statistically significant link between the level of non-performing loans and factors such as fluctuating exchange rate, bank size and loan to deposit ration. This means that a unit growth of each of these variables will increase with  $\beta$  (corresponding coefficient for each variable) units the level on non-performing loans. The exchange rate has increased by nearly 15% from 2002 to 2014. This is a very important fact considering that in the banking system almost 60% of total credit is in euro and this affects the proliferation and accumulation of non-performing loans in this currency. The major banks of Albania, even if they have greater profitability, face a higher level of non-performing loans. This

evidence which is inconsistent with previous studies can be interpreted by the fact that large banks are not necessarily more effective in screening loan customers when compared to their smaller counterparts.

On the other hand, the results of the econometric model showed an indirect, statistically significant link between the level of non-performing loans and factors such as ROE and credit growth rate. This means that a unit growth of each of these variables will decrease with  $\beta$  units the level on non-performing loans. The data from the Albanian Banking System show that profitability measured by ROE, has suffered a major decline especially after 2008 global financial crisis. This result is in line with the studies conducted in this area, as an increase of the non-performing loans would lead banks to a reduction in the level of ROE. While the literature suggest a positive correlation, my peculiar results probably reflects the conservative lending stance adopted by the Albanian commercial banks in the last years, due to their bad lending experience with the increase of non-performing loans.

Buying financial products with high risk, strengthening banking supervision and screening of banks, taking decision based on a strong analysis of the cost-benefit, etc. are the suggestions provided by some economic experts in order to decrease the level of non-performing loans in the Albanian banking system, which remains among the highest in the region, at about 24%.

## REFERENCES

- [1] Alwayn Jordan, Carisma Turcker, *Assessing the Impact of Nonperforming Loans on Economic Growth in The Bahamas*, Monetaria, July-December, 2013.
- [2] Boudriga, Taktak and Defi, *Banking supervision and nonperforming loans: a cross-country analysis*, Journal of Financial Economic Policy Vol. 1 No. 4, 2009, pp. 286 – 318, 2009.
- [3] Carlos Andres Olaya Bonilla, *Macroeconomic determinants of the Non-Performing Loans in Spain and Italy*, Dissertation submitted to the University of Leicester, 2012.
- [4] Dimitrios P. Louzis, Angelos T. Vouldis, Vasilios Metaxas, *The determinants of non-performing mortgage, business and consumer loans in Greece: A dynamic panel data study*, International Conference on Applied Economics – ICOAE, pp. 479 – 487, 2010.
- [5] Fernández de Lis, Pagés and Saurina, *Credit growth, problem loans and credit risk provisioning in Spain*, Banco de España — Servicio de Estudios Documento de Trabajo n.º 0018, pp. 1 – 35, October 2000.
- [6] Jakubik P dhe Reininger Th, *Determinants of Nonperforming Loans in Central, Eastern and Southeastern Europe*, Oesterreichische Nationalbank, Focus on European Economic Integration Q3/13, 2013.
- [7] Klein, N, *Non-performing Loans in CESEE: Determinants and Impact on Macroeconomic Performance*, Working Paper Series, No. wp/13/72, International Monetary Fund, 27 pages, 2013
- [8] Kurt Hess, Arthur Grimes, Mark J. Holmes, *Credit Losses in Australasian Banking*, Department of Economics, Working Paper in Economics 08/10 June 2008, pp. 2 – 23, 2008.
- [9] Kurti Lorena, *Determinants of Non-Performing Loans in Albania*, The Macrotheme Review, 2016.
- [10] Mancka A, *The Impact of National Currency Instability and the world Financial Crisis in the Credit Risk. The case of Albania*, Journal of Knowledge Management, Economics and Information Technology, Issue 8, 2012.
- [11] Marcello Bofondi, Tiziano Ropele, *Macroeconomic determinants of bad loans: Evidence from Italian banks*, Occasional Paper, Bank of Italy, pp. 5 – 40, 2011.
- [12] Shingjergji Ali, *The Impact of Bank Specific Variables on the Non Performing Loans Ratio in the Albanian Banking System*, Research Journal of Finance and Accounting, Vol.4, nr.7, 2013.
- [13] Shingjergji Ali, *The Impact of Macroeconomic Variables on the non Performing Loans in the Albanian Banking System During 2005-2012*, Academic journal of Interdisciplinary Studies, MCSER Publishing, Rome, Italy, October 2013.
- [14] William R. Keeton and Charles S. Morris, , *Why do banks' loan losses differ*, Economic Review, pp. 3 – 21, May 1987.
- [15] William R. Keeton, *Does Faster Loan Growth Lead to Higher Loan Losses?*, Economic Review, pp. 57 – 75, Second Quarter 1999.
- [16] Bank of Albania [www.bankofalbania.org](http://www.bankofalbania.org)
- [17] INSTAT [www.instat.gov.al](http://www.instat.gov.al)
- [18] World Bank [www.worldbank.org](http://www.worldbank.org)

## BIOGRAPHY

Klejda Gabeshi (a.k.a Kleinta Gkampeşi) is currently working as a lecturer at Logos University, Faculty of Economics in Tirana, Albania. She graduated from the Bucharest University of Economic Studies, with bachelor degree in Finance, Insurance, Banking and Stock Exchange in 2011 and Master of Science (MSc) degree in Corporate Finance in 2013. She also completed a Master of Laws in EU Business Law at University of Tirana, Law Faculty in 2014. She teaches Finance and Statistics in undergraduate programs.

# Are Natural Dyes Environmentally and Ecologically Friendly ?

Ayşe Uygur<sup>1</sup>

---

## Abstract

*Environmental protection has been considered in textile since 1980's and all treatments in textile production were reviewed environmentally and ecologically. It is supposed that natural dyes were environmentally and ecologically safe since they are natural. A fashion of natural dyed textiles also spread all over the world in 80s. But it is suggested that some dye plants such as convallaria majalis, papaver somniferum etc. were toxic when they were eaten by living organisms; some dye plant sources such as Euphorbia species, Eucalyptus species, Lawsonia inermis, Phytolacca americana etc. cause skin disorders. However, when the textile fibres are dyed by these toxic plants, only dye compounds such as alizarin, purpurin etc. will combine to the fibre whereas toxic parts such as alkaloid, photosensitive agent etc. which are available beside dye component in the plant remained in the wastewaters and these may also have harmful effects to the environment. Some mordants such as Cd (cadmium), Cr<sup>+6</sup> (chrom<sup>+6</sup>), Hg (mercury), Pb (lead), Sb (antimony), As (arsenic), Cu (copper), Ni (nickel), organic Sn (tin) compounds which are on textiles are quite harmful to human health on different scales according to Oeko-Tex 100 which is common ecotextile standard in Europe. Waste waters including these heavy metals may also entail harmful effects to the environment and ecology. Thus, it is revealed that only alum and iron mordants are safer in natural dyeing treatments. Requirement of large agricultural areas, higher density of metal mordants in waste water, relatively low fastness properties are also environmentally and ecologically drawbacks of natural dyeing.*

**Key Words:** Natural dyes; environment; ecology; toxic plants, toxic mordants.

---

## 1. INTRODUCTION

Environment is the medium in which living creatures live so natural environment involves earth, water, air thus their conditions affect the growth, health, progress etc. of living creatures.

Ecology is a science which is dealt with relationships and interactions between living creatures and their environment shared with other living creatures. Therefore there is significant relationship between environment and ecology, for example harmful heavy metals in waste waters pollute rivers environment, at the same time waste waters entail harmful ecological effect on living creatures such as fish, frog etc. which live in rivers; or on people who drink these waters or who eat these fish, frog etc.

Textile production and textile consumption may entail some environmental and ecological effect. People may be exposed to the toxic effects in the textile area by 4 ways:

- a- During the production processes of textiles (environmental and ecological effect),
- b- During the use of textiles by consumers (ecological effect),
- c- During the usage of polluted waste waters, air, earth (environmental and ecological effect),
- d- During the nutrition by fish, plant, frog etc. lived and toxicated in these polluted environment (ecological effect) as secondary effect.

It is thought that dyed textiles by natural dyes might also be less harmful to the environment since dye sources are natural, but this idea does not hold anymore because of the investigation of chemicals in toxicology, medical science, public health, environment, ecology etc. Ecotextiles are produced in consideration of human ecology and the environment in 90's, natural dyeing was also reviewed in accordance with ecotextiles.

## 2. ENVIRONMENTAL, ECOLOGICAL EFFECTS OF NATURAL DYES

Living creatures may be exposed toxic effect under different environmental conditions, so these conditions entail carcinogenic, mutagenic, allergenic, irritant etc. effects on them. Toxic effects may be occurred by eating, drinking, handling, breathing, wearing (inside textiles) etc. these toxic chemicals.

Only natural dyes were used to colourise textiles by the middle of 19<sup>th</sup> century, i.e. Industrial Revolution, then synthetic dyes were discovered and replaced almost the whole natural dyes in the world in a short time. Natural dyes are obtained from nature and they are combined to the fibre by inorganic salts called mordants. It is suggested that some of natural dye sources and mordants are quite toxic.

## 2.1. Toxic Chemicals Used in Natural Dyeing

Scientific researches showed that all natural dyes and mordants are not safe for human health and environment.

### 2.1.1. Toxic Natural Dye Sources Which Are Not Environmentally and Ecologically Friendly

Natural dye sources were soil, animals and plants when people began to colourise textile. Some of them determined as toxic.

**Dye originating from soil:** Some toxic inorganic dyes obtained from the earth are shown below:

$Sb_2S_3$ : antimony sulphide (stibnite)

$As_2S_3$ : arsenic sulphide (orpiment)

$ZnCrO_4$  (zinc chromate) +  $K_2Cr_2O_7$  (potassium bichromate) + iron rust : zinc yellow

$CdS$  : cadmium sulphide

$PbCrO_4$ : lead chromate (chromium yellow)

They are not used anymore due to toxic effect.

**Dye originating from animal:** The use of carminic acid dye which is obtained from insects (cochineal) is restricted to use in food, drinks, cosmetics and pharmaceutical products today [1].

**Dye originating from plants:** Some natural dye plants which may cause toxic effects when they were eaten by people and animals because of the toxic chemicals such as alkaloid etc. beside dye component; and skin disorders effects are shown in Table 1 [2,3,4].

Table 1 : Some natural dye plants which may cause toxic effects when they were eaten by people and animals because of the toxic chemicals beside dye ; and skin disorders.

Toxicity [ 2,3 ]	Botanical name	English Name	Skin disorders [ 2, 4 ]
1xx	Adhatoda vasica	Malabar nut	
2 1 x	Agrimonia eupatoria	Agrimony	It is said to induce photodermatitis in human
2 1 x	Alnus glutinosa	Alder	
1 0 3	Berberis vulgaris	Barberry	Those who handle the wood may develop colic and diarrhea
3 3 2	Calendula officinalis	Marigold	
1 0 x 1	Convallaria majalis	Lily of the valley	Although frequently handled by florists and gardeners, the plants causes a few or no authenticated cases of dermatitis
2 1 x	Eucalyptus sp.	Eucalyptus	Eucalyptus globulus: Sensitive people may develop urticaria from handling the foliage and other parts of the plant
x x x 0	Euphorbia sp.		The fresh latex may irritate or blister sensitive skin, it causes great inflammation in the eyes and temporary blindness.
1 0 x	Garcinia hanburyi	Mangosteen	
0 x x 1	Genista tinctoria	Dyer's broom	
1 3 2	Glycyrrhiza glabra	Licorice	
	Haematoxylon campechianum	Logwood	The active ingredients, hematein and hematoxylin, are toxic whether inhaled, absorbed through the skin, or ingested. Wear gloves, don't breathe the powdered form, and never reuse a dyeing pot for food preparation [4 ]
x x x 1	Hypericum sp.	Flowers, leaves are especially toxic for animals with light hair	
2 x x	Indigofera tinctoria	Indigo	Indigo appears to be the most mildly irritant to the eye. Dermatitis is common among indigo dyers but there is no direct evidence that indigo or its derivatives are responsible. Women shelling indigo develop an exceptionally long right thumb.
2 1 x	Lawsonia inermis	Henna	Henna dust can irritate the skin and cause contact dermatitis. When used as a dye for

			eyebrows and eyelashes there is a risk of injury in the eyes perhaps due to the astringent tannin
3 1 3	Matricaria chamomilla	German chamomile	
2 2 x	Melilotus officinalis	Sweetclover	
1 0 x	Papaver somniferum	Opium poppy	
x x x 0	Prunus amygdalus	Almond tree: only seeds are toxic	
1 x x	Prunus laurocerasus	Cherry-laurel :leaves are toxic	
x x x 1	Phytolacca americana	Poke weed, virginian poke: the root and seeds are toxic.	Handlers should wear gloves, because poke is mutagenic. Dust of the dried root irritates the eye and induces sneezing
x x x 1	Quercus infectoria	Oak apple :The fresh leaves are toxic but the dry leaves are not toxic	
1 x x	Rhamnus purshianus	Cascara sagrada, Persian berries	Emodin can cause dermatitis. Fruits eaten raw or cooked can cause a transient reddening of the skin.
	Rheum spp.	Rhubarb	Leaves, which are often used as a mordant, contain oxalic acid, which is toxic, but the stalks is not
3 3 2	Salvia officinalis	Sage	
x x x 1	Sambucus nigra	Elder	
1 x x	Sanguinaria canadensis	Blood root	Irritant to breath, nose and throat
2 3 1	Sassafras albidum	Sassafras: it is toxic with saffrole	Oil of sassafras is said to produce dermatitis in sensitive individuals
1 x 1 1	Senecio aureus	Life root	
3 x x	Solidago virgaurea	European, goldenrod	The plant produced maculopapular dermatitis with itching and burning for workers making hay for 3 to 12 hr. The irritant is said to be carried by the pollen. Case of poisonings are reported for grazing livestock in North America
x x x 1	Sophora japonica		
2 2 2 1	Tanacetum vulgare	Tansy	Tansy is said to be prohibited for botanical dealers and can not be sold as a dried herb by mail causing some cases of contact dermatitis.
x x x 1	Taxus baccata	Yew	
2 3 x	Thymus vulgaris	Thyme	Thymol has caused dermatitis in dentists. Oil of thyme, preparations has been reported to cause hyperemia and severe inflammation. It is used for chewing with the betel leaf. Some believe it causes the reddening of the mouths of betel chewers
2 x x	Uncaria gambir	Gambier	The sting is due to acetylcholine, histamine and 5-hydroxytryptamine. The juice contains lecithin and is an antidote for the nettles own sting and will quickly relieve the stinging sensation when rubbed on the affected skin spot
3 1 2	Urtica dioica	Stinging nettle	
x x x 1	Verbascum sinuatum	Heightaper	

0: Very dangerous, drinking not recommended

1: More dangerous than coffee, only a cup per day

2: As dangerous as coffee, only two cups per day

3: Safer than coffee, only three cups per day

x: Rating not available

First number: Duke; Second number : Rose; Third number: Taylor (Authorities) [2]; Fourth number: Baytop et al [3].

It is suggested that bloodroot, lily of the valley, rhododendron and azalea leaves, privet hedge trimmings, yellow flag iris rhizomes, and larkspur or delphinium flowers may be toxic to the user of dyed material [5]. Quercetin dye (oak apple) revealed a mutagenic effect in the mammalian Salmonella/Microsome test. It is suggested that laccaic acid dye (lac), crocin dye (saffron) have also toxic effect [6].

### 2.1.2. Toxic Mordants Which Are Not Environmentally And Ecologically Friendly

The environmental protection was taken into consideration in the textile field parallel to the environmental awareness in the world.

Oeko-Tex Standard 100 which is the most common ecotextile standard of textile products in Europe has limited the presence of some heavy metals in textile products. These are As(arsenic), Sb (antimony) Pb (lead), Cd(cadmium), Cr<sup>+3</sup> (chrome(+3)), Cr<sup>+6</sup> (chrome(+6)), Co (cobalt), Cu (copper), Ni (nickel), Hg (mercury) and some organic tin compounds. Öko-Tex Standard 100 revealed that only Al (aluminum) and Fe (iron) could be safer mordants than the other toxic heavy metals [7]. Öeko-Tex Standard 100 -The limit values of heavy metals on fabric in direct contact with skin are shown in Table 2.

Table 2: Oeko-Tex Standard 100 –Extractable heavy metal limits on textile fabrics in direct contact with human skin (mg/kg)

Sb (antimony)	30.0
As (arsenic)	1.0
Pb (lead)	1.0
Cd (cadmium)	0.1
Cr (chromium)	2.0
Cr (VI)	not detectable
Co (cobalt)	4.0
Cu (copper)	50.0
Ni (nickel)	4.0
Hg (mercury)	0.02

Cr<sup>+6</sup> (chrome (+6)) compounds must not be available on ecotextiles since they are carcinogenic chemicals. Permissible limits of Cd (cadmium); Hg (mercury), Pb (lead), As (arsenic) compounds have been determined under 1.0 mg/kg threshold value on the fabric since their heavy toxic effects. Permissible limit values of Co (cobalt), Sb (antimony), Ni (nickel), Cr (chrome), Cr<sup>+3</sup> (chrome (+3)), Cu (copper) compounds were determined on the fabric and these are higher than previous metals. Permissible levels of Cu (copper) and antimony (Sb) are higher than others, and they can be used to the extent permitted by the given limit values. Hg (mercury), Co (cobalt), Ni (nickel) mordants are not used commonly in natural dyeing.

According to Oeko-Tex Standard 100, it can be concluded that only Al (aluminium) and Fe (iron) mordants are nontoxic and can be used safely in natural dyeing [8]. Alum (potassium aluminium sulphate) is the most popular and least toxic among the whole mordants, however, it is an irritant, and may be harmful if ingested, so it should be used with care. It is necessary to wear a dust mask when working with alum powders and to keep them out of the reach of children and pets [9]. It is also suggested that iron mordants can be toxic in overdose but it will not harm the environment when disposed of. It requires careful work since its application dose and form is determining factor of harmful effect. Iron sulphate can cause iron poisoning in children below 6 years old under improper conditions [5].

### 2.2. Toxic Effects in Natural Dyeing Wastes

Most of the dyeing with natural dyes are applied by mordants. For 100 g wool,

15 g KAl(SO<sub>4</sub>)<sub>2</sub> (potassium aluminium sulphate) or

3 g K<sub>2</sub>Cr<sub>2</sub>O<sub>7</sub> (potassium bichromate) or

2 g ZnCl<sub>2</sub> (zinc chloride-may occur Cd) or

5 g CuSO<sub>4</sub> (copper sulphate) or

5 g FeSO<sub>4</sub> (iron sulphate) is used.

Liquor ratio : fabric (g) / bath (cm<sup>3</sup>) : 1/50

If 50 % of mordant on weight of fabric is fixed on wool, left heavy metals in waste water of natural dyeing and the limits of industrial dyeing waste waters in UK are given in Table 3 [10].

Table 3 : The comparison of heavy metals in waste waters from natural dyeing and industrial dyeing

Metal	Natural dyeing waste water (mg/l)	The limits of industrial dyeing waste waters in UK (mg/l)
Al	340	2.0
Cr <sup>+6</sup>	100	0.5
Zn	200	10.0
Cu	260	2.0
Fe	480	10.0

Toxic metal limits of natural dyeing waste waters are too much above permissible limits. These waste waters must certainly be discharged to the environment after sufficient dilution.

Natural dyes does not mean that they are sustainably or organically raised or harvested. If the harmful pesticide, herbicides, defoliants, etc. are used during the agricultural production of dye plants and textile fibres, they may also be seen in the waste waters. Besides, some of dye plants may also include some toxic chemicals such as alkaloid and photosensitive agents etc. beside dye component, if they have not been degraded during the dyeing procedure, and then they could go into waste waters and may also entail harmful environmental effects.

A remarkable amount of solid waste is also left after the natural dyeing procedure. Especially large amounts of natural dyeing need large areas for the solid waste remaining. This also may create additional environmental pollution. Solid waste- if containing toxic chemicals- must certainly be buried under the earth or it must be burnt.

Additionally natural dyes normally require much greater energy in the dyeing process as they usually require high temperature baths for longer periods of time than the optimized synthetic dyes [4].

### 2.3. The Production of Natural Dye Sources' Effect on The Environment

1 g Synthetic dye is equal to 150 g dried plant or 450 g fresh plant. It is suggested that the world's total cotton dyeing needs only 176 million ton fresh plant and this is equal to 31 % of agricultural field of the world in 1993. From this point of view, total world dye requirement cannot be met by natural dyes.

It is known that 1 kg dye from 150 000 dried cochineal are picked up from the cactus settled in a field of 0.16 hectare. This can not be considered as environmentally friendly production since cultivation of natural dye needs much more area than that of food cultivation [10].

### 2.4. Fastness Properties of Dyeings

Although some natural dyes have good light fastness on textiles such as logwood black (by using chromium mordant) at 4-5, indigo at 3-4, cochineal (by using tin mordant), madder (by using alum and tin mordant), lac (by using tin mordant) at 3-4, some natural dyes have lower light fastness on textiles such as old fustic, persian berries at 1-2. It is suggested that the mordant is more important than the dye itself in determining the light fastness of coloured textiles.

As a general rule, natural dyes (on wool) have only moderate wash fastness as assessed by the ISO tests. However, logwood and indigo are much more faster [1].

Oeko –Tex Standard 100 has lowered some dye fastness properties by 3, therefore natural dyes having only fastness above 3 are in accordance with this standard, the others are not acceptable. This standard also has forbidden some dyes which have toxic azo groups. Surprisingly there are no natural dyes including azo groups [7].

So, natural dyes which have only fastness properties upper 3 are suitable on today's textiles, but only some natural dyes meet these requirements.

## 3. CONCLUSIONS

If it is reviewed by today's environmental understanding, all natural dyeing procedures can not be considered as environmentally, ecologically friendly application.

There are some inorganic natural dye sources which are toxic such as PbCrO<sub>4</sub> (lead chromate), CdS (cadmium sulphide) etc. K<sub>2</sub>Cr<sub>2</sub>O<sub>7</sub> (potassium bichromate) etc. are quite harmful to human health and to the environment. They are forbidden today.

There are some dye plant sources which are toxic for people and animals such as Convallaria majalis, Hypericum species etc. when they are eaten.

Some dye plant sources such as Euphorbia species, Eucalyptus species, Lawsonia inermis, Phytolacca americana etc. cause skin disorders. Therefore it must be considered that handlers should wear gloves while picking up these plants.

However, when the textile fibres are dyed by these toxic plants, only dye compounds such as alizarin, purpurin, pseodopurpurin etc. will combine to the fibre, and toxic parts such as alkaloid, photosensitive agent etc. will remain in the bath after dyeing. Therefore, textile fibre dyed with toxic plants may not be harmful to the human health, but if the solid or liquid waste of dyeing contains some toxic chemicals, it may also be harmful to the environment. There are some inorganic salts used as mordants which are toxic such as Cr<sup>+6</sup> (chrom<sup>+6</sup>), Pb (lead), Cd (cadmium), Hg (mercury), As (arsenic), Sb (antimony), Cu (copper),

Ni (nickel), organic Sn (tin) compounds are quite harmful to human health and to the environment according to Oeko- Tex 100 which is common Ecotextile Standard in Europe. So, they must not be used as mordant on natural dyeing. Only Al (aluminium) and Fe (iron) mordants are considered as nontoxic mordants according to today's environmental understanding if they are used carefully and if some precautions are taken into consideration.

Therefore, textiles dyed by natural dyes can not be completely considered as safe to human health and the environment. They are safe if they are dyed by environmentally friendly dye sources such as madder, anthemis tinctoria etc. which are grown naturally without chemical pesticide and fertilizer; if harmless mordants such as aluminium (Al) and iron (Fe) are used ; and if they need only small agricultural areas and show fastness properties higher than 3.

## REFERENCES

- [1]. G. W. Taylor, "Natural Dyes in Textile Applications", *Rev. Prog. Coloration*, Vol.16, pp 53-61,1986.
- [2]. A. J. Duke, *Handbook of Medicinal Herbs*, CRC Press Florida, USA, 1991.
- [3]. T. Baytop, A. Baytop, A. Mat.S.Sun, *Türkiye'de Zehirli Bitkiler, Bitki Zehirlenmeleri ve Tedavi Yöntemleri*, İ.Ü.Yayınları, No 3560, Eczacılık Fak., No 54, Gençlik Basımevi, İstanbul, Turkey, 1989.
- [4]. O ecotextiles, <https://oecotextiles.wordpress.com/tag/natural-dyes/> ( access date: 15/6/2016).
- [5]. P. Bencht, All About Hand Dyeing, <http://www.pburch.net/dyeing/FAQ/naturalsafety.shtml> ( 15/6/2016).
- [6]. U. Sewekow, 'Natural Dyes- An Alternative to Synthetic Dyes?', *Melliand Textilberichte*, Vol. 4, pp. 271-276, E. 145-147,1988.
- [7]. Oeko-tex Standard 100, [https://www.oeko-tex.com/en/business/certifications\\_and\\_services/ots\\_100/ots\\_100\\_limit\\_values/ots\\_100\\_limit\\_values.html](https://www.oeko-tex.com/en/business/certifications_and_services/ots_100/ots_100_limit_values/ots_100_limit_values.html)
- [8]. Woolery, <http://woolery.com/dyeing/natural-dyes/information-on-natural-dyes.html>
- [9]. Dharma Trading Co., <http://www.dharmatrading.com/home/synthetic-vs-natural-dyes.html>
- [10]. B. Glove, J.H.Pierce, 'Are Natural Colorants Good For Your Health?' *JSDC*, Vol.109, pp. 5-7, Jan.1993.



# The Future of Organic Fibers

Ayşe Uygur<sup>1</sup>

---

## Abstract

*Organic fibers which are produced without chemical fertilizer, pesticide and genetically modified seeds (GMO) under the certification for organic fibres processing and these are generally natural fibers. Organic fibers require much more time, labor, cost value, care and special agriculture areas than conventional fibers. Organic fibers are not enough to make the cloth safe since finishing treatments may entail some additional toxic effects. Therefore Global Organic Textile Standard (GOTS) which includes environmental and social aspects of whole production has been accepted recently.*

*Organic textile production has environmental- ecological, economical, social positive impacts: Environmental- ecological impacts: Prevention of the pollution of natural sources by ceasing chemical fertilizer; chemical pesticide; contribution to prevention of global warming; decrease of consumption of the natural sources: soil, water, weather; decrease of energy requirement; standards for the protection of human health and biological diversity by textile standards; decrease of waste such as biological degradation, recycling; Economical impacts: Cost value of organic fibre production and selling*

*Social impacts: Promotion of organic fibres, management of organic fibres.*

*The future of organic fibers in the world depends on some dimensions such as textile, agriculture, environment- ecology, social life, economy etc. It is as follows mainly that the amount of consumption of organic fibers in textile area instead of other fibers; the growing possibilities of organic fibers in agriculture; positive impacts of organic textiles to environment and ecology; people becoming conscious about their health and environment by wearing organic textile products; buying capability of consumers to wear these organic textiles which are more expensive than conventional ones etc. will determine the future of organic textile production in the world. A brief review will be done on environmental subjects above and the future of organic fibers will be revealed at above conditions.*

**Keywords:** *Organic fibers, Organic textiles, Organic cotton, Environmental protection, Pesticide, Fertilizer, GOTS Standard.*

---

## 1. INTRODUCTION

Natural textile fibres are obtained from vegetable sources such as cotton, kapok, linen, ramie, hemp, jut, sisal; from animal sources such as wool, mohair, cashmere, silk, spider silk. Viscose, cupra, acetat rayons from wood and linters; kazein from milk, silkool from soya, zein from maize, ardil from peanut are also obtained from natural sources but they are not in fibre form, then they are extruded into fibres after required special treatments and these are called as regenerated fibres. Polyamide, polyester, polyacrylonitrile, polyurethane, polyvinylchloride, polyethylene, polypropylene, polybenzimidazole etc. are synthetic fibres produced by synthesizing chemicals obtained from petroleum and then they are extruded into fibres after required special treatments. Even though natural fibres are dated to B.C.8000 and still are being used; regenerated and synthetic fibres has begun to be produced since A.C. 19. Century e.i since Industrial Revolution. Industrial Revolution has brought also environmental pollution while industrial production has being increased by using industrial chemicals; fosile fuels such as petroleum, coal, and natural gas has being begun to be used in industry, thereafter nuclear, wind, sun, bio, geothermal etc. energies has begun also to be used in industry [1].

Industrial revolution improved in all industrial areas quickly, The World was polluted and changed in a huge ratio as never seen before such as thinning ozon layer; destruction of ecological life; pollution of weather, water and soil; global warming; climate change; melting icebergs in Poles; increasing waste etc. It may be added to these, the increase of people population in the world. The interest in environmental pollution increased in 80's all over the world in all areas, in textile as well. Some precautions are thought in textile area such as using natural fibres instead of synthetic fibres; producing organic fibres, ecotextiles, recycled fibres; dyeing by natural dyes; not using chloride bleaching agent etc. [2].

Organic fibres are the special production of conventional natural fibres which do not use chemical fertilizers; toxic pesticides (insecticides, herbicides or fungicides, defoliant) and genetically modified seeds (GMO). Organic fibres follow also a certification for organic fibres processing [3].

Application of the amount of chemical fertilizers and pesticide are very important since their excessive use entails quite harmful effects by degrading the soil, reducing its nutrient and water retention capacity; by decreasing the crop yield; by contaminating their toxic effects on waters which they pass through; by polluting weather with solvents or volatile compounds when pesticides are applied; by increasing global warming occurred nitrogen oxide (N<sub>2</sub>O) since the excessive use of nitrogen originated fertilizers; by exposing farmers and living creatures these toxic chemicals; by creating toxic effect on crops from

---

<sup>1</sup>Corresponding author: Marrmara University, Güzel Sanatlar Fakültesi, Tekstil Bölümü, Küçükçamlıca, 34660, Kadıköy/İstanbul, Turkey uygur\_ayse@yahoo.com

pesticide residue etc. The goal of organic fibre production is to protect the natural sources and people health besides all living creatures and their sustainable life conditions [3 ] [4]. Certification of organic fibres needs some hard procedure such as ceasing the use of pesticides, chemical fertilizers before three years followed by organic cultivation; using only permissible substances; covering physically the borders of cultivation fields; cultivating some trap plantes if necessary; using organic manure etc.; enrichment of soil organically etc. [5 ].

It was true that only natural fibres were produced up to Industrial Revolution and they were organic. Organic fibres has begun to be produced since 80's again and encouraged by public actions who were aware of 'green' and 'sustainable production'. It is expressed that organic fibres such as cotton, linen, hemp, jute, wool, mohair, silk were produced in some parts of the World. But despite of these intensive environmental action, it is not registered a significant improvement for 30- 40 years. For example organic cotton, the leading of organic fibres was only produced 0.7% of conventional cotton in the world in 2012 [ 6 ]. The other organic fibres such as linen, hemp, wool , silk etc. are produced only in a small ratio. Organic cotton has currently been grown in 23 countries, mainly India, China, Turkey, Tanzania, USA etc.

### Organic fibres which are produced all over the world

**Organic cotton:** Conventionally cotton in the world uses % 25 of pesticide (16% of all the insecticides and 6,8% of all herbicides used) [7] and cotton is in the 4<sup>th</sup> place in the use of chemical fertilizers in the world, and needs 33% fertilizer of raw cotton weight during cultivation [8] Even though GMO seeds are forbidden in organic cotton, GMO seeds are used in the organic cotton production in USA [7]. The production of conventional and organic fibres in the world is given in Table 1 [6] [7] [9] [10].

Table 1: Conventional and Organic Fibres in The World

	Conventional Cotton Lint			Organic Cotton Lint		
	Production (M ton)	Cotton % among fibres	Cotton cultivated area M Ha	Production (ton)	Organic Cotton %	Organic Cotton cultivated area Ha
1960	10,113	67,5	30-36			
1999-2000	20,2	37,5		7545	0.04	
2000-2001	18,869	38,1		6480	0.03	
2001-2002	21,281	38,4		18000	0.08	
2003/2004	21,135	36,9		25394	0,10	
2005/2006	26,532	38,6	30-36	37799	0,14	
2006/2007	26,751		34,36	57931	0.20	
2011/12	27,100		35,52	139000	0.50	317000
2013/14	25,700			116974	0.40	220765
2015/16	21,87		30,49			

As can be seen in Table 1; conventional cotton production is about 25 M tons during 2000's and it is consumed about 38% among other fibres involving nearly 30-36 M Ha cultivation field in the world which corresponds approximately 2.5% of agricultural areas of the world. When it is glanced organic cotton; total production is about 6500-139000 tons during 2000's and it is produced about 0.038-0.5% of conventional cotton (0.7% also suggested [6] ), 317000 Ha (2012) cultivation field in the world. These results show that organic cotton had not registered promising progress for 30-40 years.

**Organic linen:** Linen is made from flax, a crop that requires very little pest-controlling chemicals. Flax plant is harvested for its fibers, seeds, and seed oils. It's also best when it's a teeny bit wrinkly, so you can conserve energy by putting away the iron [11].

**Organic Hemp:** The hemp plant is harvested for its fibers, seeds, seed meals and seed oils including narcotic property. Oil is produced from females which have been left to stand after the fiber-producing males have been harvested. **It is easy to grow hemp organically**, since it **does not require herbicides and fertilizers** and hemp does not have a high water requirement. It has a root system that aerates the soil and draws nutrients and water from deeper soil layers, so the requirement of fertilizers and irrigation decreases [12].

**Organic Wool:** Organic wool requires strict regulations such as feeding sheep from the last third of gestation must be certified organic; prohibiting synthetic hormones, genetic engineering of the sheep, synthetic pesticides on pastureland, and also parasiticides on sheep [13].

**Organic silk:** Organic silk would involve growing the mulberry trees organically, without chemicals, and raising the silkworms humanely and without hormones [14]. Peace silk or vegan silk permits the moth to make a hole on cocoon, ceasing its death in cocoon, despite of the decrease of fibres quality [11] .

**Alpaca:** Organic alpaca sheeps do not require insecticides to be injected into their fleece, are fairly self-sufficient, do not need to be treated with antibiotics. It seems that they are good for environment [11].

### 2-IMPACT FACTORS OF ORGANIC TEXTILE

Organic textile production has environmental- ecological, economical, social positive impacts:

Environmental- ecological impacts: Prevention of the pollution of natural sources by ceasing chemical fertilizer; chemical pesticide ; contribution to prevent global warming; decrease of consumption of the natural sources : soil, water, weather; decrease of energy requirement; standards for protection of human health and biological diversity; decrease of waste such as biological degradation, recycling; Economical impacts: Cost value of organic fibre production and selling

## 2.1. Preventing the Pollution of Natural Sources by Ceasing Chemical Fertilizer

All vegetable natural fibres need some inorganic compounds, organic compounds, water, CO<sub>2</sub>, sun light, seed, and soil treatments to grow up. As example, cotton plants requirement under irrigation are 100–180 kg/ha nitrogen (N), 20–60 kg/ha phosphorus (P), and 50–80 kg/ha potassium (K) compounds; chemical fertilizers to supply these compounds are added to fields for the cultivation of conventional fibres[15]. But these chemical fertilizers are forbidden for organic agriculture since their excessive use creates harmful effects such as soil degradation, reduction of its nutrient and water retention capacity, salinization, erosion, eutrophication, the overextraction of water and the reduction of ecologic diversity as well as human health on the agricultural area. Carbon nutrient amount 0.5 to 5 % of the soil, has also crucial importance[4]. Excessive use of nitrates, phosphates fertilizers and pesticides which occur methane and nitrous oxide gases by spreading air and their solutions in ground and surface waters which entail also environmentally and ecologically harmful effects [15]. 1 kg of cotton lint requires 350 g chemical fertilizer and cotton is in the 4<sup>th</sup> order in the use of synthetic fertilizers [8].

Natural organic fertilizers such as organic manure, compost of green leaves, stalks, roots etc. manure, mulch, liquid organic manure such as ( biogas) slurry and micronutrient were used instead of chemical fertilizers to meet the requirement of cotton fibre growth [4 ] [16].

Crop rotation is also an alternative practice to fertilize application for the achievement of soil fertility. It helps prevent soils, occurrence of critical pest populations and also diseases and weeds from leaching. It is important to grow cotton in rotation with leguminous plants such as beans, peas or soya beans. Because they fix nitrogen from the air and make it available to the plant, thus improving soil fertility [4 ] .

## 2.2. Preventing the Pollution of Natural Sources by Ceasing Pesticides

All crops are under the biological effects such as animals, insects, beetles, bacteria, fungi, weed etc. as well as physical and chemical effects. These biologically living beings can give damage to natural fibres resulting the decrease of yield, the quality of fibres, and the increase of difficulties in fibre processing. To prevent these biological effects pesticides, insecticides, fungicides, herbicides, defoliant are used during the cultivation of crops. Natural vegetable fibres also require pesticides, a leading of natural fibre cotton only consumes 25% of pesticide consumption in the world since it is highly susceptible for pests and diseases. But these pesticides and solvents are quite toxic and excessive use of pesticide depletes the soil nutrients thus the requirement of synthetic fertilisers will increase[12]. Ground and underground waters are also polluted by pesticide contamination causing soil salinisation, particularly in dry areas and causing a degradation of soil fertility and the occurrence of methane and nitrous oxide gas [17].

Additionally volatile pesticides or solvents of pesticides are spread into weather causing harmful effect on employees, crops, air, earth, water. These pesticides are persistent chemicals and they leave a toxic residue on cotton lint, leaves, stems, roots, seeds, even in the soil. The amount of pesticide in the earth is increasing as time passes by and entails toxic effect. Pesticides in cotton fibres are also persistent[18] . Pesticides are not generally soluble in water, they are persistent chemicals to degradations. Then they may be left on textile products to create harmful effect on textile consumers. That's why, organic chlorinated pesticide are tested on ecological textiles for Oekotex 100 and GOTS standards. Toxic pesticides used in the production of conventional cotton are methamidophos, malathion, aldicarb, parathion, acephat etc. [7] . The total dose of pesticide chemicals vary between 1.85 kg/ha and 10.5 kg/ha in the selected region [15]. There are some researches to remove organophosphate pesticides (OP) pesticides from waste waters [19].

Organic fibre production prohibits the use of pesticide and **some natural precautions are suggested and these will decrease** the pollution of natural sources in the world.

**Natural pesticides:** If preventive measures are not sufficiently efficient and pest populations exceed the economic threshold, a number of natural pesticides can be used in organic cotton cultivation. Some of these are: neem spray, prepared from neem kernels (*Azadirachta indica*) extract, effective against sucking pests, jassids, bollworms and thrips; pyrethrum, prepared from powdered flower heads or liquid extracts of *chrysanthemum*, effective against red cotton bug, cutworms, grasshoppers; botanical mixtures, combinations of extracts from different plants such as castor, thorn apple, lantana, custard apple, sweet potato leaves, tomato leaves, ginger, chilly, *glicicidia*, marigold, etc. Their cost values consist 10% of market price.

**Trap crops:** Some cotton pests prefer crops like maize, sunflower, okra (lady finger), sorghum, pigeon pea or hibiscus to cotton. By growing these crops along with cotton as a trap crop, the cotton crop is spared.

**Promotion of natural enemies:** Not using pesticides and diversifying crops benefit natural enemies from cotton pests such as birds, ladybirds, beetles, spiders, parasitic wasps, bugs and ants. They help the farmer keep pest attacks at tolerable levels by providing suitable habitats for these natural enemies of pests.

**Crop rotation:** This helps prevent leaching from soils, a build-up of critical pest populations and also diseases and weeds[4 ] .

## 2.3. Contribution to Prevention of Global Warming

Global warming is an environmental problem caused by carbon dioxide (CO<sub>2</sub>), methane, nitrous oxide etc. gas layer occurred in the atmosphere and this layer acts as a preventive and a trapping heat from the earth and warming the planet. Fossil fuels and

all industrial production entail global warming [20]. Global carbon dioxide (CO<sub>2</sub>) concentrations in the atmosphere are expected to rise from 350 ppm to over 400 ppm which entail between 0.5 and 1 °C of a global warming by 2030. Carbon dioxide has also positive effect on plants, it causes plant stomata to narrow, so water losses are reduced and the efficiency of water usage improves. Increasing atmospheric concentrations of carbon dioxide will also stimulate photo-synthesis of plants and have a fertilizing effect on many crops [16]. Fibre plants absorb carbon dioxide (CO<sub>2</sub>) under sun light, then giving back oxygen (O<sub>2</sub>) by photosynthesis. Photosynthesis cleans the weather, helps reduce global warming. It is suggested that, on average, organic cotton cultivation causes 0.98 kg CO<sub>2</sub> equivalent/1 kg of cotton fiber produced, this compares to 1.81 kg CO<sub>2</sub> equivalent/ 1 kg of fiber for conventional cotton [10].

But natural fibres entail the increase effect onto global warming in reverse because animals breath oxygen (O<sub>2</sub>) then give back as carbon dioxide (CO<sub>2</sub>). Global warming is also the result of the Industrial Revolution, the gases released to atmosphere due to industrial production in a large amount. Some international precautions were thought to decrease carbon dioxide (CO<sub>2</sub>) level to lower 5% of 1990's level at Kyoto Protocol.

Some synthetic fertilizers used in the conventional vegetable fibres have contribution to global warming. They spend 1.5% of the world's annual energy consumption and release large amounts of carbon dioxide during their production. Additionally the excessive application of nitrate fertilizers transformed into nitrous oxide ("laughing gas"), that is 300 times more destructive than carbon dioxide (CO<sub>2</sub>) in terms of global warming [4]. Pesticides have also increased effect on global warming by spreading green gases. Organic fibres have contribution to the decrease of global warming by ceasing fertilizers and pesticides.

#### 2.4. Consumption of the Natural Sources: Soil, Water, Weather

It is suggested that while cultivable land is 0.218 hectare / 1 person in 2010, it will be 0.181 hectare / 1 person in 2050, that means that crop consumption will decrease per head in future [21]. Cotton production includes 2.5% of agricultural areas in the world corresponding to 30- 34 million hectares in the recent years. If conventional cotton is reversed to organic cotton, this will create a great benefit for the environment and ecology [9]. Conversion of conventional cotton field to organic field needs 3 years, organic cotton yield is approaching to that of conventional cotton in the third year approximately 1100 kg lint/ ha of yield. It is important that adjacent agricultural fields must cultivate similarly since pesticides and herbicides applied in a field could easily transport to an adjacent field, thus it loses organic cotton property [15]. Sustainability of soil depends on strongly the organic cultivation.

Water is the main material for living organisms, and there is no life without it. Every year, many treatments are performed to treat, clean and purify water. Therefore, availability of clean water at an affordable price remains a crucial goal for humanity. Cotton is a very water-intensive crop; it is estimated that cotton growing results in 1–6% of the world's total freshwater withdrawal. In order to produce 1 kg of cotton lint, 10,000–17,000 L water is required. Innovative irrigation techniques like drip irrigation, can lower the water demand for cotton production down to 7000 L/kg-lint [15]. When conventional cotton is compared to organic cotton at the point of the consumption of conventional cotton, there may not be difference if the cotton yields are both the same; if organic cotton yield is lower than that of conventional cotton, water consumption may be higher than that of conventional cotton.

Water consumption of the cultivation of organic cotton in India, USA, Israel are given in Table 2 [22].

Table 2: Water Consumption of Organic Cotton

Water Consumption of Organic Cotton			
Country	Water consumption m <sup>3</sup> /ha	Yield seed cotton kg/ha	Water Conservation Measure
Maikaal- India	2950-4100	1200-1400	Crop rotation
USA	1500-4500	2200-4200	Drip irrigation
Israel	1300-2800	2900-4700	Mulching, hoeing of soil crust to break evaporations capillar

Oxygen in weather is always consumed by all chemical oxidation reactions, energy reactions in a large amount. Oxygen is reversing carbon dioxide by combustion. Plants transform into carbon dioxide to oxygen by photosynthesis. Oxygen is always consumed by chemical reactions, if plants are available enough amount, always transform into carbon dioxide

#### 2.6. Decrease of Energy Requirement

Vegetable fibre production depends on energy in a high ratio which includes cultivation, fertilizer and pesticide applications, irrigation, machine harvesting, ginning, transportation of natural fibres, yarn production, knitting or weaving, finishing treatments, sewing clothes, transportation clothes. All these stages include carbon foot print in different ratios, some of them can be applied by hand such as harvesting, cultivation, weaving etc. which arise carbon dioxide (CO<sub>2</sub>) in a small ratio. It must be also added washing, ironing, dry cleaning etc. treatments which are applied by textile consumers and which require energy to these stages. It is suggested that consumer use needs 80% of the life cycle energy of a conventional cotton textile products

[15]. Conventional and organic fibres spend the same energy except chemical synthesis of fertilizers, pesticides; for mechanical applications of chemical fertilizers and pesticides; excessive wet treatments to remove pesticides on textile products. Whereas the production of 1 kg of conventional cotton requires 15 MJ energy, 1 kg of organic cotton requires only , as a global average, 5.8 MJ of energy [10].

Energy sources today are mainly fossil fuels such as charcoal petrol, coal, and natural gas; nuclear energy; renewable energy such as sunlight, wind, rain, waves, geothermal heat, biomass, hydro electricity. Energy production is the prevalent factor of environmental pollution, and arising carbondioxide ( CO<sub>2</sub>), methane etc. from fossil fuels in a large ratio causes global warming. Thus renewable energy sources are recommendable for the ecological production. Replacing diesel fuel with biodiesel in the machinery, preferably produced from agricultural wastes and residues, would theoretically improve further sustainability of the final product [15].

## 2.7. Standards for Protection of Human Health and Biological Diversity

Organic fibre production only assures that the fibres are produced the lack of fertilizers, pesticides, GMO seeds, thus there will be no pesticide residue on textile products; and organic fibres requires organic fibre certification system.

But textiles are treated in the textile mills such as scouring, bleaching, dyeing, finishing etc., these may also create some toxic effects on environment and the textile consumers. Even though these textiles are produced by organic fibres, it can not be assured that the textile product is safe for human health of consumers. That's why a standard like Global Organic Textile Standard ( GOTS) is also added to the organic standard.

**Organic Fibre Standard:** EU regulation 834/2007; USA National Organic Program (NOP); United States Department of Agriculture ( USDA) ; OTA: Organic Trade Association (USA) (Agriculture and foods into organic textiles and body care products); Indian National Program for Organic Production (NPOP) ; the Japanese Agricultural Standard (JAS); Soil Association Organic Standard ( UK); Organic Guarantee ( New Zealand); IFOAM: International Federation of Organic Agriculture Movements [4] [23].

**Organic Exchange:** OE 100, OE Blended Standards and the new Organic Content Standard is also suggested by Textile Exchange [10]. **Organic Fibre+ Ecological Processed Product : GOTS :** *Global Organic Textile Standard stipulates that organic fibres or yarns, fabrics, textile products from these organic fibres* were treated and manufactured ecologically and have no toxic effects on consumers. But it does not include any preventions or precautions to protect environment from toxic by-products contained in the wastewater from manufacturing plants of these textiles pollute wastewaters, giving harmful effects on ecosystem [13].

**MTS:** Market Transformation to Sustainability (Sustainable Textile Standard examines garment sustainability in five areas of sustainability ) standards also include ecological textile products.

Some labels of ecological cotton are given in Figure 1 [24].



Figure 1: Organic Cotton 100 Label; GOTS Label; Fair Trade Label; Better Cotton Label successively.

**Ecotextile Standard:** There are some ecotextile standards such as EU Flower, eco-label and Oeko-Tex 100 that they do not require organic fibres, but they stipulate that the end textile product were ecologically treated and manufactured and have no toxic effects such as allergy, skin irritations, chemical sensitivity and other health problems.

**Better cotton:** Environmentally friendly and sustainable cotton cultivation by controlling all stages without decrease in crop yield, in contrary by increasing the crop yield and keeping the cost the same. Harmful effect decreases 30-50 % that of conventional cotton. ( BCI) [7].

**Fairtrade:** It is primarily a social label and focuses on improving the working and living conditions of smallholder farmers in the South. However, Fairtrade standards also include environmental criteria.

**Fairtrade and Organic complement:** Combining the two is a way of strengthening the position of farming families socially and environmentally as well as supporting their development efforts [4].

**Cotton quality order:** It is given successively Organic cotton ; Better cotton without GMO ; Better cotton with GMO ; Conventional cotton. [7]

## 2.8. Biodegradable Property of Organic Fibres

Biodegradable means that a material will break down or decompose through microbial action into basic elements found in nature. Many materials over time will degrade from sunlight, heat, moisture and mechanical stress, but this alone is not biodegradation. Compostable means that a material will break down quickly in a typical composting operation into nutrient-

rich, soil-conditioning mixture Heat, humidity and regular mixing, quickly break down the waste. Natural fibres are biodegradable, but synthetic fibres are recalcitrant to biodegradation and need long period of time giving pollutant products Certain studies have found the synthetic material to be an endocrine disruptor that can potentially effect the fertility. Organic fibres will biodegrade environmentally friendly while conventional fibres will give residual pesticide to the environment.

## 2.9. Recycling Organic Natural Fibres

Natural fibres and synthetic fibres can be recycled by tearing machines in a shorter length. Most of the time fresh and recycled fibres are mixed to produce new textiles. Conventional and organic textiles have no difference at the point of recycling, if there is pesticide residue on textile, this may only create toxic effect. For every kg of virgin cotton displaced by second-hand clothing approximately 65 kWh is saved, and for every kilogram of polyester approximately 90 kWh is saved [15].

**Synthetic fibres are convenient for recycling process through melting polymer followed by fibre production from extruder. But natural fibres are not convenient to melt treatment since they have no melting properties. Especially recycled plastic bottles or even recycled polyester fabric are used in recycle process by melting process [11].**

## 2.10. Economical Impacts: Cost Value of Organic Fibre Production and Selling

Organic fibres need more care, labor, procedure than conventional fibres, that's why organic fibres cost approximately higher than 5-50 % than conventional fibres in the world. But the total price of a textile product from organic cotton is higher 5-10 % than that of conventional cotton, since the other treatments such as yarn, weaving, finishing etc. are the same for both types. Fibre amount in the textile product will increase the price so as heavy sweatshirt will be more expensive than that of light one even though they were made of organic cotton[6] [11]. Organic and conventional cotton prices in 2013/14 period in the first 5 countries as India, China, Turkey, Tanzania, USA in the World are given in Table 3 [10] [26].

*Table 3 Cotton lint price in the first 5 countries in 2013/14 (correspond to 96 % of organic cotton world production)*

	India	China	Turkey	Tanzania	USA	World Conventional Cotton
Organic Cotton Lint Price (\$ / kg)	1,52	2,08-3,20	1,60-2,15	-	2,60-3,40	
Organic Cotton Seed Price (\$ / kg)	-	1,04	-	0,43-0,46	-	
World Conv. Cotton Lint Price (\$ / kg)						1,48

Transition period of conventional cotton to organic cotton requires 3 years, but the decrease of yield in three years creates a serious economical problem. Even though increasing awareness on environmental issues besides organic fibres was tried to be created, the result is not at the promising level recently. Some textile companies have begun to produce organic textiles, some of them have begun to produce only an organic line among their products. Demand and offer will determine the future of organic textiles.

## 2.11. Social Impacts: Promotion of Organic Fibres, Management of Organic Fibres

The more demand to organic fibres increases, the more production of organic fibres increases. Basic factors which affect the demand of organic textile products: 1-Sufficient knowledge about organic fibres and their harmful impacts on the environment, ecology: There is no enough visual or written knowledge to explain, to make the consumers conscious about the production process of organic textiles 2-Having economical capacity to pay organic textiles being about 10% of higher price than that of conventional one: There are about 8 billion people in the world, most of them are living under insufficient conditions. That's why only people having higher salaries can pay the increase in price of organic textiles

8 3-Accessibility to organic textiles: Consumers have different ability during shopping, price, model, colour, season, fibre type, accessibility etc. are the basic reasons. Organic fibres are being produced only in a small amount and it is also difficult to find, to access organic textiles all over the world, this is also a drawback of organic textiles.

It is suggested that consumers have three knowledge which affects buying organic textiles: objective knowledge, subjective knowledge that is the perception of what and how people know, and knowledge usage which is gained from prior experience. This result stimulates new marketing methods, presentation, making people conscious studies to increase organic fibres demand. Renewable sources and sustainable production must be explained to consumers strictly.

Organic cotton did not show gradually increase in production and consumption for 40 years. Organic markets are only available in the developed countries such as UK, Europe, the US, Canada, Japan and Australia etc. , and in their elite shops. The global market share has gone around 4.3 Billion USD in 2009 [4]. Even though the benefits of using organic cottons instead of conventional cottons in apparel products are well acknowledged among consumers, they tend to choose conventional cotton clothing over organic cotton clothing due to relatively higher price. Organic cotton producers and retailers need to improve organic cotton production and trading processes to provide organic cotton clothing at more affordable prices [27]

The decrease in production was a problem of not having enough resources to produce organic cotton including the lack of seeds; the lack of pre-financing options; difficulty in finding capital and health care centers; accessing to training and advisory services.

The farmers may perceive the crop prices as too low, and therefore not making the investment required for organic production. This risk is especially high for farmers depending on rain, not using irrigation. In this case, it is necessary incentive precautions for farmers.

### 3. CONCLUSIONS

It is obviously seen that world is getting dirtier day by day. All sustainable precautions to prevent the pollution is worth to stimulate, like organic cotton, to leave habitable world for future generations.

There are mainly environmental- ecological, economical, social diameters from the transition conventional fibres to organic fibres; cotton is the leading of organic cultivated fibres.

Organic fibres will have environmental- ecological benefits to cease pesticides, fertilizers, GMO which entail declining yields and, therefore environmental sources such as weather, water, soil besides human health and ecosystem will be protected. Organic cultivation will supply sustainable production being environmentally friendly.

Transition to organic fibres requires about three years and the organic crop yield decreases during these years by entailing the decrease of cost value which is important for livelihood of farmers. The main problem is how can it be compensated this lost? The premium of organic cotton may surpass the conventional cotton if the first three years are compensated by some ways. This may be supplied by governmental support, incitement all over the world, transition to organic cultivation may be performed gradually. It is suggested that finding capital, seeds, health care centers, accessing to training and advisory services are even more important.

The cost value of organic textiles is higher than that of conventional. If consumers demand and pay this premium of organic production, offer of farmers will increase, therefore social awareness of consumers must be increased to buy organic products. Despite of harmful effects of conventional fibres to environment and human health; for example the production ratio of organic cotton in conventional cotton is still 0,7 % , this revealed that social interest must certainly be created. Demand, it was said, will overcome these issues.

Transition to organic fibres requires the collaborations among International Farmers Associations, Non Governmental Organisations, Governments, Trademarks, Consumers Associations and Fashion Designers. Organic textile demand from consumers could not be promising levels by now having 0,5%-0,7% of conventional cotton, due to about 10% higher price. Considering of this issue in new and creative ways may be a potential solution.

### REFERENCES

- [1]. A.Uygur, D. Yuksel, *Tekstil Baskı Stilleri*, İstanbul, Turkey, Tekstil İşverenleri Sendikası, 2011.
- [2]. J. Watson, *Textile and the Environment*, London, UK, New York, USA, Business International, Special Report No. 2150, 1991.
- [3]. Textile Exchange–Cotton Briefings- Organic by Choice-.2011 [Online]. Available: <http://textileexchange.org/>
- [4]. Organic cotton, [Online]. Available: <http://www.organiccotton.org/oc/Cotton-general/Cotton-general.php>
- [5]. Organic cot.[Online]. Available: [https://en.wikipedia.org/wiki/Organic\\_cotton#Organic\\_system.5Bcitation\\_needed.5D](https://en.wikipedia.org/wiki/Organic_cotton#Organic_system.5Bcitation_needed.5D)
- [6]. C. Altenbuchner, M. Larcher and S. Vogel, The impact of organic cotton cultivation on the livelihood of smallholder farmers in Meatu district, Tanzania, *Research Renewable Agriculture and Food Systems*, 31(1), 22–36, Oct. 2014. doi:10.1017/S1742170514000416
- [7]. I. Tarakçıoğlu, *Organik Pamuk ve Tekstil Sanayii*, İstanbul Ticaret Odası, Yayın No. 2008-7, İstanbul, SDG Reklamcılık, 2008
- [8]. Organik Tekstil ve Konfeksiyonun Üretim Sektörüne Katkıları ve Geleceği, [Online]. Available: <http://www.apelasyon.com/Yazi/297-organik-tekstil-ve-konfeksiyonun-uretim-sektorune-katkilari-ve-gelecegi>
- [9]. World Agricultural Production, [Online]. Available: <http://apps.fas.usda.gov/psdonline/circulars/production.pdf>
- [10]. Textile Exchange, [Online]. Available: <http://textileexchange.org/> 2016 Report
- [11]. Green L., [Online]. Available: <http://www.greenlivingonline.com/article/guide-natural-and-eco-friendly-fabrics>
- [12]. The Organics Institute [Online]. Available: <http://theorganicsinstitute.com/organic/organic-clothing/>
- [13]. O Ecotextiles, [Online]. Available: <https://oecotextiles.wordpress.com/2009/08/11/>
- [14]. Green Cotton, [Online]. Available: <https://greencotton.wordpress.com/2008/05/21/silk-just-how-green-is-it/>
- [15]. G. Baydar, N. Ciliz, A. Mammadov, Life cycle assessment of cotton textile products in Turkey, *Resources, Conservation and Recycling*, 104, 213–223, 2015.
- [16]. RF., Channagouda, HB., Babalad, SP., Dineshkumar, Effect of organic manures, green leaf manures, liquid organic manures and micronutrients on yield and economics of cotton (*Gossypium* spp.), *Indian J. Agric. Sci.*, VL 85, 10, P.25-30, Oct., 2015.
- [17]. Prospect for the Environment, [Online]. Available: <http://www.fao.org/docrep/004/y3557e/y3557e11.htm>
- [18]. Y. Li, HB. Zhang, QB. Li, Q. Zhou, XB. Chen, C. Tu, YM. Luo, P. Christie, XF. Hu, LZ. Li, Characteristics of residual organochlorine pesticides in soils under different land-use types on a coastal plain of the Yellow River Delta, *ENVIRONMENTAL GEOCHEMISTRY AND HEALTH*, VL 38, 2, P.535-547 APR., 2016
- [19]. R.M. Abdelhameed, H. Abdel-Gawad, M. Elshahatb, H.E. Emam, Cu–BTC@ cotton composite: design and removal of ethion insecticide from water, *The Royal Society of Chemistry Advances*, 6, p. 42324–42333, Apr. 2016. DOI 10.1039/c6ra04719j
- [20]. Climate hot map, [Online]. Available: <http://www.climatehotmap.org/about/global-warming-causes.html>
- [21]. E. Ertek, Tarım Arazileri, TSKB Ekonomik Araştırmalar, Temmuz 2014, [Online]. Available: [http://www.tskb.com.tr/i/content/727\\_1\\_Tarim%20Arazileri%20Bilgi%20Notu\\_Temmuz\\_2014.pdf](http://www.tskb.com.tr/i/content/727_1_Tarim%20Arazileri%20Bilgi%20Notu_Temmuz_2014.pdf)

- [22] Summary of the Organic Cotton Community discussion about „Water consumption in organic cotton production“, 17 August – 16th October 2009.
- [23].A. Hariram, Organic Clothing,[Online].Available: <http://www.slideshare.net/akaashi20/organic-clothing-9507365>
- [24].Textile Exchange - Organic Cotton Market Report – 2016 [Online]. Available : <http://textileexchange.org/>
- [25].Textile Exchange, Farm Hub,[Online].Available: <http://farmhub.textileexchange.org/learning-zone/pricing-organic>
- [26]. Trading Economics, [Online]. Available: <http://www.tradingeconomics.com/commodity/cotton>
- [27]. K. Oh, L. Abraham, Effect of knowledge on decision making in the context of organic cotton clothing, *INTERNATIONAL JOURNAL OF CONSUMER STUDIES*, VL 40, 1, P 66-74, JAN, 2016. DI 10.1111/ijcs.12214



# Migration of Women from Rural to Urban in Turkey

*Nermin Bahsi<sup>1</sup>, Dilek Bostan Budak<sup>2</sup>*

---

## Abstract

*Migration from rural to urban has been a relatively important issue in Turkey. Since 1950, the industrialization and urbanization process had a negative effect on living conditions of farmers and it has led to internal migration from rural to urban areas. Of course, rapid industrialization is not the only reason for migration. To have better educational opportunities also led rural people to migrate. Marriage and living with children is one of the major triggers on the migration of women. The sharp inferiority seen in marriage age of women in rural areas, and frequent occurrence of male-dominated attitudes in family relationships; make women more desperate and cause this social problem more complicated. Economic and social factors, better service in health and also willing to leave the villages to cities can be listed for as other reasons. Agriculture and poverty are very closely related. Rural women suffer from poverty far more than rural men. Nowadays, more than 1 billion people in the world are dealing with poverty. Unfortunately, majority of them are women who live in developing countries. The hope of living within better conditions is another reason for women's rural to urban migration. But when they migrate they have no choice but to live in slum places with unhealthy conditions. Migrant rural women are employed generally in labor-intensive and low wage sectors such as textile, in-home cottage industry and house cleaning. In this paper, the migration process is analyzed from women's perspective in Turkey.*

**Keywords:** Migration, rural, Turkey, women

---

## 1. INTRODUCTION

Migration is a social event that left deep traces in the consciousness of people and communities. In every era of history, various migration has emerged due to changes in the living conditions with the political, social and environmental factors [1]. Migration can be defined as an act of placement of the individuals or communities going from one to another settlement or from one to another country in consequence of economic, social or political reasons. Being basically a movement of displacement, the migration is a fact of change and transformation that incorporates both the individual aspects and social dimensions [2].

Migration from rural to urban has been a relatively important issue in Turkey. Since 1950, the industrialization and urbanization process had a negative effect on living conditions of farmers and it has led to internal migration from rural to urban areas. Of course, rapid industrialization is not the only reason for migration. To have better educational opportunities also led rural people to migrate. Marriage and living with children is one of the major triggers on the migration of women. The sharp inferiority seen in marriage age of women in rural areas, and frequent occurrence of male-dominated attitudes in family relationships; make women more desperate and cause this social problem more complicated. Economic and social factors, better service in health and also willing to leave the villages to cities can be listed for as other reasons. Agriculture and poverty are very closely related. Rural women suffer from poverty far more than rural men. Nowadays, more than 1 billion people in the world are dealing with poverty. Unfortunately, majority of them are women who live in developing countries. The hope of living within better conditions is another reason for women's rural to urban migration.

Unfortunately, urban labor markets cannot absorb these internal migration flows and internal migrants cannot easily gain access to formal employment once settled in their destination places. As a consequence, all internal migrants are somewhat involved in the informal sector and face economic and social integration problems. New cultures of poverty and new survival strategies have emerged among those migrants who live on the margins of urban life [3]. But when they migrate they have no choice but to live in slum places with unhealthy conditions. Migrant rural women are employed generally in labor-intensive and low wage sectors such as textile, in-home cottage industry and house cleaning.

## 2. MIGRATION in TURKEY

Industrialization and mechanization of agriculture in Turkey since the 1950s caused significant improvements in the socio-economic structure resulting from the process of internal migration and migration from outside starting since mid-1960[4]. The society entered into a process of rapid capitalization and mechanization of agriculture in the 1950s and as a result, the land and population in rural areas are out of balance. The labour force felt out of production and began to migrate to the metropolis [5]. With the process of urbanization, the proportion of the population living in cities has increased significantly.

The rapid migration occurred in Turkey has created a striking variations on the rate of rural-urban population. In 1950, 19% of Turkey's population while living in urban areas, this rate increased to 36% in the 1970s and 56% in 1990s. In this period, within the heavy increase of the urban population the effect of internal migration is over 50% [6]. Due to the political and social events in the East

---

<sup>1</sup>Corresponding author: Korkut Ata University, Kadirli School of Applied Science, Osmaniye, Turkey. [nerminbahsi@osmaniye.edu.tr](mailto:nerminbahsi@osmaniye.edu.tr)

<sup>2</sup>Cukurova University, Department of Agricultural Economics, 01330, Saricam/Adana, Turkey., [dbostanbudak@gmail.com](mailto:dbostanbudak@gmail.com)

and South-East Anatolia, in 1980s and 1990s, forced or indirectly forced migrations has been raised and have led to significant changes in the socio-cultural structure of the urban centers in the region. According to this move, the social and economic changes happened; the health, education, urbanization, social security and other problems have emerged [7].

In Turkey, in general, a large part of the migrant people is immigrating with a hope of better living conditions and family reasons seems to be the most important cause of migration for all phases of migration.

Thus, optional migration, forced migration, permanent or temporary migration, transit migration, illegally migration, chain migration, stepless phased-migration are mentioned as many types of migration [8]. The most commonly used classification of migrations is based on different criteria into two according grouping immigration, internal migration and emigration. Certain areas within the country's borders, internal migration (city center, town center, districts and villages) are defined as between population mobility. Whether short-term, whether long-term mobility once inside most of the population in the same social system combine to form immigration. It made the migration to neighboring countries or to areas farther. It is used to define the geographical displacement movement. The distance from different levels between emigration and immigration units, in the political sense, more specific control of the migration and the different dimensions of integration problems of immigrants, spot migration features that distinguishes it from internal migration [9].

## 2.1. Causes of Internal Migration

- The rapid population growth in rural areas causing land division and not meeting the livelihood of the family,
- The infertility of the soil by erosion,
- The increasing mechanization in agriculture reduced the need for labor in rural areas,
- The limited job opportunities in rural areas, especially for women,
- More sources of income and business opportunities due to the advanced industry in urban areas,
- Preferable and better urban education and health services than the rural areas,
- The occurrence of natural disasters such as earthquakes, landslides, floods.

## 2.2. Results of Internal Migration

- Unbalanced distribution of the population,
- Unbalanced distribution of investment,
- As a result of irregular urbanization, the industrial facilities remaining in the city, and the deficiencies in infrastructure (roads, water, electricity, communications) services,
- Increase in unemployment in the cities and the formation of excessive population growth,
- Vacant areas of agricultural land and regression of livestock in the areas that occurs migration.

## 3. WOMEN AND MIGRATION

Urban, rural and urban-rural identities have been discussed with the migration that began in the 1950s. Most of the migrating population are living in the slums similar to their villages [10]. In 2011, it was reported that 4 million slum places were existed in Turkey [3]. The economic and social problems are exacerbated poverty and deprivation in these areas, and the women are more affected from these risks that have been brought by these cases [11]. The causes of migration "linked to immigration" is often caused by a predominantly female migration. Interconnecting family immigration for any reason (to find a job, job assignment, etc.) is a phenomenon that describes the movement of women who follow their migrating male members. Here, rather than as individual migration decisions independent of the woman, the position in the family (wife, mother, daughter) is depending on the question of moving to a new location.

The migration for women, to be an independent decision as an individual, rather than depending on the position in the family, is realized as a necessity to move to a new location. Another reason for the women-specific migration is called as "marriage migration". Even if encountered less commonly, women are able to migrate at their own request; unlike jobs due to economic migration or regardless of their political migration and refugee, within the framework of immigration status, the women are also involved in migration, independently from the male members of the family. In the same context, another migration again, mainly due to women-specific "marriage migration" is able to handle the nude [12]. In the areas where live the migrated individuals, the studies show that the women can not adequately benefit from prenatal care; due to the socio-cultural and psychological-based factors such as economic status, environment, fear and being familiar. The birth rates are low in the hospital while the structures of births at home without medical personnel appear to be high [13, 14, 15].

When primary health care which is a part of the maternal and child health and family planning services is evaluated in terms of the recruitment of individuals who migrate, it seems to not to be enough to benefit from these services. For the migrant women, to have children due to traditional culture, it has to be considered as very important for the continuation of the status and beliefs cause low utilization of family planning services [15]. Therefore, among the migrated women with particularly low level of education it is seen that they have more children, they do not have sufficient knowledge on family planning methods and correspondingly to this, they have high abortion rate.

When considering the dietary habits of the migrating individuals, it is verified that they do not have an adequate and balanced nutrition, they are fed mostly by fat and carbohydrates mainly depending on the economic conditions and habits. The activities are decreased and the index of body mass is found to be higher in women than in men [16]. The malnutrition developed in children, is also a health problem that causes serious consequences up to death. In studies, it is determined that the height-weight ratio of the children of the individuals who immigrated are negatively affected and they have lower percentiles values [16, 17].

It is a known fact that the disability of health care benefits of the migrating individuals are due to the economic conditions as well as the lack of health care, not having health insurance, inability to answer the needs of local services, strangeness, laws, economic reasons, transport, having no one to look after the kids for working women, working hours, language reasons [16, 14].

Özgören et al. (2002) analyzed the data which were collected for the first time in Turkey Demographic and Health Survey (2000) to look at the migration reasons of ever-married women. They found out that the marriage was the most common reason (41%) for migration. Partner related reason placed at the second place with 26% [18]. The works of Barut (2001), Yıldırak et al. (2002), Özbekmezci and Sahil (2004), Türkyılmaz (2004), Başak Kültür (2004), Yüksek and Kurban (2009) and Kaya et al. (2009) pointed out in their research's that both children and women are forced to work as men are not equipped with proper qualifications to work in the labor market of the big cities. Women become caretakers, textile workers and cleaners, whereas children work in the other sectors of the informal market (like waiters, street sellers) [19, 20, 21, 22, 23, 24, 25].

#### 4.CONCLUSION

Population growth in the rural areas, agricultural mechanization, fragmentation of the existing land by inheritance have resulted to a deficiency on living on an amount of money or to unemployment, which accelerated the migration. The hope of living within better conditions is main reason for women's rural to urban migration. But when they migrate they have no choice but to live in slum places with unhealthy conditions. It is known that the migrating individuals have psychological distress as well as physical problems according to migration. The women and children are the most affected by this mental breakdown. The women are faced with mental disorders due to the post-traumatic stress disorder, cultural conflicts, changes in family roles and family reasons such as violence. In children, fear and introversion (autism) are common complaints [16, 17]. In addition to these factors negatively affect the health of migrating individuals, the inadequate health services in regions where they settled and the low use of services more and more lead to increased health problems. The studies show that the health centers are in an inadequate number, they could not keep regular records of the population they serve, they failed to identify the problems of the population at risk, the preventive health services are not started to provide more outpatient services when they should, and the vaccination rate gradually decreases. In this case, adequately benefit from basic health care of individuals who migrated fails and ultimately leads to encounter the avoidable health risks [17, 13]. Government should plan the immigration process to decrease the negative effects. More importance should be given women and youth education in rural areas.

#### REFERENCES

- [1]. O. Deniz, Türkiye'nin doğu sınırı ve mülteci sorunu. Yüzüncü Yıl Üniversitesi Bilimsel Araştırma Projeleri Başkanlığı, 2005-FED 811 Nolu Proje Raporu, Van, 2008.
- [2]. M. Güler. Kente göç eden kadınların aile planlaması ile ilgili tutumları. Ulusal Sosyoloji Kongresi, Ankara, 1996.
- [3]. Gesellschaft für Versicherungswissenschaft und Gestaltung e.V. Social Impact of Emigration and Rural-Urban Migration in Central and Eastern Europe, Final Country Report, 2012.
- [4]. Y.Z. Özcan, Türkiye'de iç göç. İstanbul, Türkiye Ekonomik ve Toplumsal Tarih Vakfı Yayını, 1998.
- [5]. S.Kızıkcılık. Mersin'e göç etmiş insanların sağlık koşulları üzerine bir çalışma. II. Ulusal Sosyoloji Kongresi, 20-22 Kasım 1996 Ankara, Türkiye Kongre Özet Kitabı Sayfa 657-665, 1996. [5]. F. Erari. Türkiye'de göç ve kentleşme süreci. Standart 2001; 40(475):78-85, 2001.
- [6]. E. Kongar. Toplumsal Değişme kuramları ve Türkiye gerçeği, 7. Baskı, Ankara, Remzi Kitapevi, 1999.
- [7]. M. Mutluer. Göç sorunsalı üzerine Kuramsal çerçeve, İstanbul, Çantay Kitapevi, 2003.
- [8]. A. İçduygu, T. Ünalın, Türkiye'de iç göç. İstanbul, Türkiye Ekonomik ve Toplumsal Tarih Vakfı Yayını, 1998.
- [9]. T. Erman. The impact of migration on Turkish rural women: Four emergent patterns, Gender and Society, 12 (2) pp.146-167.
- [10]. T. Kocaman. Türkiye'de İç Göçler ve Göç Edenlerin Nitelikleri, (1965-2000), DPT Yayını, Ankara, 2008.
- [11]. P. İlkaracan and İ. İlkaracan. 1990'lar Türkiye'sinde Kadın ve Göç" Bilanço 98: 75 Yılda Köylerden Şehirlere, Tarih Vakfı Yayınları, İstanbul, 1998.
- [12]. N. İpekyüz. Güneydoğu'da iç göç tartışmaları ve sağlık boyutu. Toplum ve Hekim, 11(74): 56-60, 1996. [14]. Ozen 1996.
- [13]. U.K. Choudry. Health promotion among immigrant women from India living in Canada: Journal of Nursing Scholarship, 30(3):269-274, 1998.
- [14]. M. Ertem, Göç ve bulaşıcı hastalıklar. Toplum ve Hekim, 14(3):225-228, 1999.
- [15]. N. İpekyüz. Güneydoğu'da iç göç tartışmaları ve sağlık boyutu. Toplum ve Hekim, 11(74): 56-60, 1996.
- [16]. N. Çobanoğlu. Tıp etiği açısından göç ve sağlık. II. Ulusal Sosyoloji Kongresi Kitabı. Ankara, Devlet İstatistik Enstitüsü, 1996. [17]. T. Erman. Rural migrants and patriarchy in Turkish cities. International Journal of Urban and Regional Research 25 (1), 118-133. 2001.
- [18]. A.A. Özgören, M.A.Eryurt and İ.Koç. Determinants of Women's Migration in Turkey. Hacettepe University Institution of Population Studies. Ankara, Turkey, 2002.
- [19]. M.Barut. Zorunlu Göçe Maruz Kalan Kürt Kökenli T.C. Vatandaşlarının Göç Öncesi ve Göç Sonrası Sosyo Ekonomik, Sosyo Kültürel Durumları, Askeri Çatışma ve Gerginlik Politikaları Sonucu Meydana Gelen Göçün Ortaya Çıkardığı Sorunlar ve Göç Mağduru Ailelerin Geriye Dönüş Eğilimlerinin Araştırılması ve Çözüm Önerileri (IDPs in Turkey and Their Problems). İstanbul: Göç-Der. 2001.
- [20]. N. Yıldırak, B. Gülçubuk, S. Gün, E. Olhan, and M. Kılıç. Türkiye'de Gezici ve Geçici Kadın Tarım İşçilerinin Çalışma ve Yaşam Koşulları ve Sorunları (The Conditions and the Problems of Temporary and Women Agricultural Women in Turkey). Ankara: Tarım-İş. 2003.
- [21]. Ş. Özbekmezci, S.Sahil. Mevsimlik Tarım İşçilerinin Sosyal, Ekonomik ve Barınma Sorunlarının Analizi. Gazi Üniv. Müh. Mim. Fak. Dergisi, 19: 261- 274. 2004.
- [22]. S. Türkyılmaz. The Experiences of Two Generations of Women in Poverty: A Case Study in Çamdarlı, Altındağ in Ankara, Unpublished MA Dissertation. Social Sciences Institute, Middle East Technical University. 2004.

- [23]. Başak Kültür ve Sanat Vakfı. Ses Çık: Sorun Etme Sahip Çık Projesi. Zorunlu Göçün Çocuklar ve Gençler Üzerindeki Etkileri (The Impact of Forced Migration the Children and Youth). İstanbul: Başak Kültür ve Sanat Vakfı Yayınları. 2004.
- [24]. D. Yüksek, D.Kurban, D. Permanent Solution to Internal Displacement: An Assessment of Van Action Plan for IDPs. İstanbul: TESEV. 2009.
- [25]. A. Kaya, E. Işık, B. Şahin. Günümüz Türkiye'si'nde İç Göçler: Geri Dönüş mü Entegrasyon mu?. İstanbul: İstanbul Bilgi University Press. 2009.

# Use Of Solar Energy On Agricultural Lands In Turkey

Ufuk Gultekin<sup>1</sup>, Dilek Bostan Budak<sup>2</sup>

---

## Abstract

Changing climatic characteristics and increasing fossil originated fuels use steer global attention to sustainable energy systems. Emerging technologies, coming with decreasing costs and increasing efficiency, enhance usage of non-polluting renewable energies systems. Development in these clean technologies such as solar energy becomes strategic not only on economic advancement but also has a significant impact on agricultural improvement. While agricultural products and food prices in the world are in a downward trend; in Turkey they are still increasing above inflation values. One of the major reasons causing this situation is input costs. Especially, expensive electricity and fuel costs bring farmers heavy financial difficulties. On lots of agricultural lands; because of not having mains electricity; irrigation is done by using fueled generators. Today's classic irrigation pumps are generally settled; only considering the points where the mains supply is located. And not estimating their efficiency and trying only to lower installation costs; increase the variable expenses, energy use and overall costs. These fossil fueled energy suppliers are not only costly and noisy, but also have a continuous additional fuel expense. On the other hand; irrigations done with solar powered pumps are economic, silent and environment friendly. Additionally; when there is no need electricity on agriculture land; redundant energy coming from solar system is sold to main network and brings extra profit to the farmer. Although installation costs of solar system seems expensive in the beginning; that investment will pay for itself in medium term. In this paper, the potential of solar energy, its use in agriculture and its role on sustainable development is discussed.

**Keywords:** Agriculture, extension, solar energy, sustainable, Turkey

---

## 1. INTRODUCTION

As an important part of the Turkish economy and culture, the agriculture can perform a significant role in distributed generation of energy. The land is traditionally managed with the stewardship of the farmers who protect the land, air and water beside their investment support in renewable energy. The energy costs are stabilized, the pollution and the greenhouse gases are decreased, and the need for electric grid infrastructure improvements is delayed by solar energy, within the other renewables offering the same opportunities.

The maintenance costs are cheaper in solar energy systems as the time going by, and via subsidies and energy savings that recover the higher initial cost of the system, the fuel is free of charge.

In the times of the lack of grid connection, the generators have been powered by the fossil and gas fuels which have traditionally been used in agricultural operations. But, on the other hand, while using these fuels, many problems occurred such as the cost of the transportation of the fuel, the volatility of the fuel costs, fuel spillage, the noise made by the generators, noxious fumes and the need for high maintenance. The necessity in agriculture has implemented a beneficial alternative that is "Solar Energy". The required energy can be provided by the cost-effective solar systems whenever and wherever it is needed. Concurrently, the design of these solar systems are high-spirited and they are simple to maintain as well [1].

## 2. TYPES OF SOLAR SYSTEMS

Generally, the utilization of the solar systems is separated into two types:

- 1.Solar electric
- 2.Solar thermal

The electrical power is converted by the solar electric from solar energy. Thus, the solar energy is used by the solar thermal for heating the air or the water. The usable energy is created by the conversion of the sunlight with the aid of the solar energy and the solar thermal, in turn with their applications in agricultural settings, the farmers and ranchers are helped and satisfied by that energy they required in their operational works.

### 2.1. Solar Electric (PV Systems)

The electricity is directly generated by PV (Photo Voltaics) devices from sunlight via an electronically process. Certain materials naturally have it. The electrons are let free by solar energy and are induced to roam through an electrical circuit that powers an

---

<sup>1</sup> Cukurova University, Department of Agricultural Economics, 01330, Saricam/Adana, Turkey. [gulteku@gmail.com](mailto:gulteku@gmail.com)

<sup>2</sup>Corresponding author: Cukurova University, Department of Agricultural Economics, 01330, Saricam/Adana, Turkey., [dbostanbudak@gmail.com](mailto:dbostanbudak@gmail.com)

electrical load. The electricity is mainly used for the irrigation, the livestock operations and the dairy facilities in agriculture. Likewise, it is commonly utilized in lighting, to freshen the air, to refrigerate, to heat the water/space, to pump and to fan for aeration and crop drying.

Two categories of PV applications are available: on-grid and off-grid. On-grid PV systems are stuck together with the utility grid; the electrical loads can be powered by them at the location or out of use of produced energy, they can feed it back into the electrical grid. On the other hand, the off-grid PV systems and the utility grid are not connected to each other the provision of power onsite in remote areas is contributed.

The main advantage of the On-Grid system to the farmers is that the surplus electricity can be fed back into the mains. Thus, the farmers are got rid of the fixed installation cost of the energy storage equipment and are avoided from energy loss during the recharge/discharge of the batteries. [1].

## **2.2. Solar Thermal**

### **2.2.1. Active systems**

Solar energy is used to heat a fluid either liquid or air by the usage of active solar heating system and after that the solar heat is directly transferred to the interior space or to a storage system for later use. In case of any lack of satisfactory space heating provided by the solar system, an additional heat is supplied by an auxiliary or back-up system. Within the inclusion of the storage, the use of the liquid systems is frequent. Radiant heating systems, boilers with hot water radiators and even absorption heat pumps and coolers look suitably appropriated for them. Forced air systems can be supplemented by both liquid and air systems. [2].

One of the good example of the active systems is solar water heater. The farms need hot water for every day and the amount varies depending on the size of the farm. They are usually covered with using wood for water heating. As solar collectors offer a technology for heating the water that encourage massive use of solar energy in agriculture based on their economy, the environment and social gains are affected by this simple and flexible technology.

### **2.2.2. Passive systems**

There are many design approaches of passive solar heating. One of them is collectively passive solar design. Blended suitably, the heating, the cooling and the day lighting of almost any building and construction can be contributed by these strategies. There is a wide range of application of the passive solar heating. The types of buildings and constructions that benefit from this consist of barracks extending over large maintenance facilities.

To reduce the demand for space heating, solar heat gains are collected, stored and distributed by the building components that are taken the advantage of the passive solar heating systems. The use of mechanical equipment is not required by a passive solar system because the heat flow is by natural means, such as radiation, convection, and conductance, and the thermal storage is in the structure itself [3].

In winter season, the heat is let into the building with the aid of a good design of passive solar buildings; on the other hand in summer and in especially very hot summer days, the sun is blocked by them. The passive solar design elements such as shading, implementing large south-facing windows and building materials absorbing and slowly releasing the heat of the sun, help to achieve this function.

“Crop and grain drying” is an example for passive systems. Solar energy is extensively used by the farmers to dry crops and grain that lie under the sun. This is a very old application for centuries. The crops are naturally dried in the field or the grains and fruits are spread out in the sun after harvesting is finished. This technique is the simplest and cheapest one [4].

## **3. POTENTIAL IN TURKEY**

Turkey has a large solar energy potential because of its geographical location. The average of many years of meteorological observations, Turkey's annual sunshine duration is estimated over 2600 hours (Totally, 7,2 hours a day), and average solar radiation is 1311 kWh / m<sup>2</sup>-year. Although, the Italy, which has nearly same average solar radiation with Turkey, produced 24,676 MW from PV in 2015 and ranked as top players in the world. This amount is nearly 1000 times greater than Turkey has (Map 1) [5].

## Global horizontal irradiation

## Europe

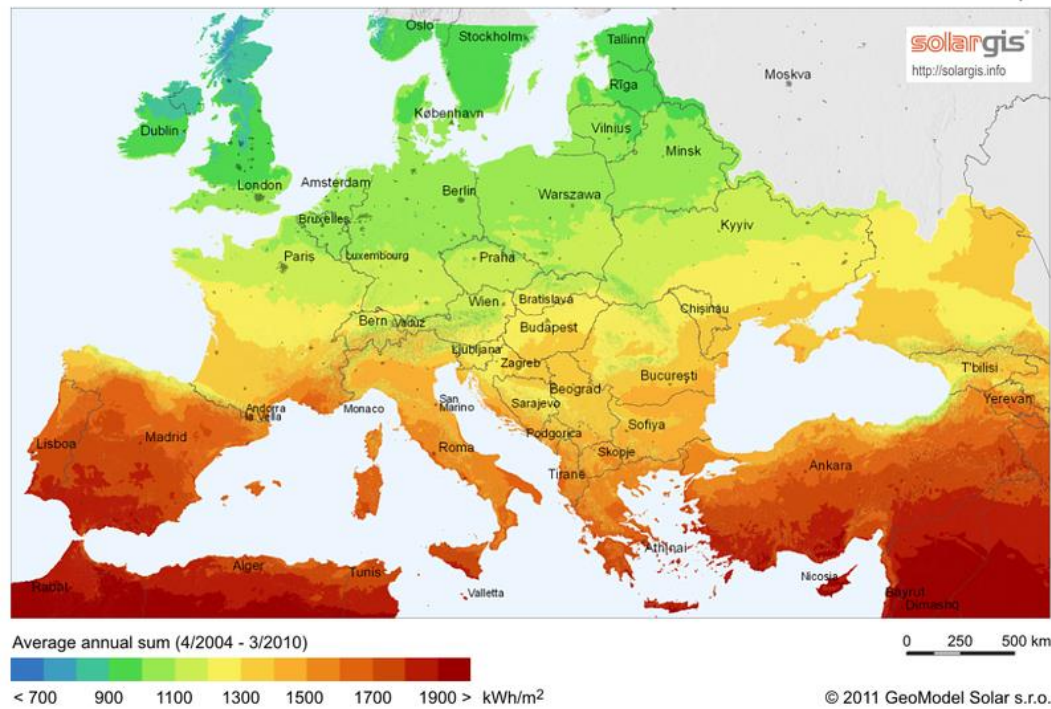

Although our country is in good condition in terms of solar energy potential, unfortunately this potential is not sufficiently effective and widespread in use. Solar energy can be used in agriculture in different ways to save money and sustainability. As seen in Figure 1, in Turkey, the initial investment cost of solar irrigation system is higher than that of diesel. But after a short span of 6 years, PV systems becomes more advantageous to the diesel ones [6].

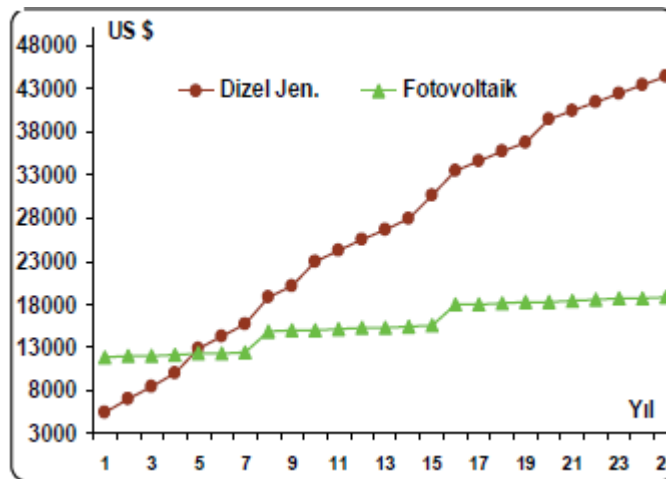

Figure 1: Total costs comparison of a PV system and Diesel Generator system

According to Öztürk (2004), if solar energy will be used in agriculture, production will increase, needed electricity will meet, cost of lighthining will decrease, living conditions of farmers' will increase and have a free hot water [7]. Unfortunately, in Turkey farmers mainly use solar energy for heating and drying crop. Rural women can also use solar energy for cooking.

## 4. CONCLUSION

With each passing day, as the world's population expands and grows, it enters a tight bend. In 2050, by its doubling, the need for food will be doubled as well. About this subject, the worldwide platforms will confront huge and disagreeable consequences and their results occurring in the global economic systems, environment, agriculture and climate the energy choices of global altitude in a short term.

In this article, we tried to discuss about the use of the solar energy and why is clean energy necessary in agriculture.

If we concentrate on solar power and irrigation, Turkey's economy is based largely on agriculture, which consumes a seriously excessive electrical energy in irrigation practices. In our country, solar energy is a high potential source and there is a great

benefit in the establishment of water pumping systems fed by solar cells for small-scaled agricultural irrigation cart purposes, primarily in the regions where is no electrical energy or the delivery is difficult and expensive. Although the initial setup costs of this system are high, when considered in long-term basis the PV system is considerably an economical approach [8].

In agriculture sector, the reductions are used by fossil fuel energy. The promotion of renewable energy technologies can achieve it in various applications. The concept of sustainable agriculture to maximize crop productivity while minimizing the use of natural and finite resources, harmful environmental effects is based on a delicate balance of economic stability.

Although our country is in good condition in terms of solar energy potential, unfortunately this potential is not sufficiently effective and widespread in use. The reason is the lack of coordination between agencies, and so far, the government does not give enough incentive practices as well. Agricultural extension services should provide educational opportunities to inform the benefit of solar energy.

## REFERENCES

- [1] M., Xiarchos, Irene and Brian Vick. *Solar Energy Use in US Agriculture: Overview and Policy Issues*. US Department of Agriculture, Office of the Chief Economist, Office of Energy Policy and New Uses, 2011.
- [2] <http://www.solar-energy-at-home.com/active-solar-energy.html>
- [3] <http://www.wbdg.org/resources/psheating.php>
- [4] K.E., Tuna and D., Bostan Budak, Need Of Clean And Sustainable Energy Systems In Agriculture, 1<sup>st</sup> International Black Sea Congress On Environmental Sciences (IBCESS), Giresun,, TURKEY, August 31 - September 03, 2016.
- [5] <http://www.renewableenergyworld.com/articles/2016/02/solar-pv-provides-7-8-percent-of-italy-s-electricity-in-2015.html>
- [6] 552-1119-1-SM.pdf
- [7] H.H.Öztürk. Yenilenebilir Enerji Kaynakları ve Kullanımı. Teknik Yayın Evi. Ankara, 2008
- [8] M., Atmaca, G.,Yusufoğlu, and A.B., Kurtuluş, Güneş Enerjili Sulamanın Tarım Sektöründe Uygulaması, *Bitlis Eren Üniversitesi Fen Bilimleri Dergisi* 3.2, 2014.



# A Collaborative Study on the Physical and Social Meaning of Doorbell: Problems and Solution Suggestions

*Ozan Soyupak<sup>1</sup>, Humanur Baglı<sup>2</sup>*

---

## Abstract

*Doorbell is both a physical and social link between indoor and outdoor environment of people. Since its first usage, people benefit not only from its physical properties, but also from its social and emotional properties. In this study, current usage of the doorbell, further usage scenarios of it, the ways of sustaining its physical and social meaning while applying new technological developments to it will be discussed and handled as a design problem. Problem field is tried to be determined with the help of the design thinking approaches and methods. Detailed information about the determined problem has been collected and solution suggestions and alternatives tried to be improved. In every stage of the study like problem definition, detailing or suggestion, co-working constituted the main path of the study. In order to do that, workshops were made. So, problem has been analyzed in a more detailed way. In this study, current problem, user profiles, suggestions to the current problems of the doorbell are shared systematically. The data, gathered by this study, can form the research basis of a product development activity of a doorbell. Needs, applied solutions and suggestions of different user groups on mentioned subject has made this study valuable.*

**Keywords:** *design thinking, doorbell, methods*

---

## 1. INTRODUCTION

This study is carried out within the context of Design Thinking course as part of the ITU Industrial Design Phd Program. The researcher has taken the course as a PHD student in 2015-2016 Fall Semester. The course has continued once in every week for 3 hours long. Theoretical part of the course has been handled shortly by the nature of design thinking and at the beginning of the term students were asked to define a problem and study subject on that problem by applying different design thinking methods and approaches. "A day in a life" method has been used for basing the problems on daily life and easing the problem definition stage. The study has been tried to be improved by weekly works done within and after the course hours. Thinking and practice stage which was very raw at the beginning, has begun to be matured by time. Inner and outer works of the course, such as workshops and literature reviews develops maturing process. At literature review stage, design thinking methods have been searched and the most suitable method to be applied to define and solve the problem have been focused on.

The researcher has found the preliminary data, gained by "a day in a life method", as insufficient to define the problem and afterwards he preferred to reveal the problem by co-working in order to achieve anonymous problem. By so, researcher would be able to focus on a problem which has broader social and cultural context and to focus on an object that works as a medium for cultural sustainability. In total, 3 workshops were done. First one was focused on problem definition with a broader context. At second and third ones problem zone tried to be examined in a more detailed way. At first workshop, a series of methods were applied one after another to create a harmony/composition, possible alternatives of problems were gathered by co-working. Outcomes of the first workshop were shared in the lecture by the researcher, afterwards one of the alternatives were focused on, and at the same lecture second lecture were done by graduate students taking the same course. Most of the graduate students taking the course had an undergraduate degree in Industrial Design, for that reason more conscious critiques and feedbacks were given on methods, approaches and usage about the problem. Third workshop was done also in lecture time as the second one according to the feedbacks. Out of the alternative problems of first workshop, front door bell was chosen as the problem area by the researcher.

## 2. LITERATURE REVIEW

Design thinking uses methods as tools, which can be used by everybody like professional designer, manager, students etc. For design thinking it is important to put on other's shoes, to see other's eyes, to reveal their stories and to share their world [1]. Understanding their emotions, ideas, desires make the designer reach to their conscious and make it easier to emphasize.

Methods are the guides for avoiding unnecessary efforts and taking the right action instead of the wrong one. Method is defined by the "Türk Dil Kurumu Eğitim Terimleri Sözlüğü (1974) as: "a regular path consciously followed or chosen to solve a

---

<sup>1</sup>Corresponding author: Istanbul Technical University, Department of Industrial Design. 34437 Beyoğlu / İstanbul. ozansoyupak@gmail.com

<sup>2</sup>Istanbul Technical University, Department of Industrial Design. 34437 Beyoğlu / İstanbul. bagli@itu.edu.tr

problem, to result an experiment, to learn or to teach a subject”. If we look at the design thinking with the help of this definition, we primarily come across its being a solution and idea development focused methodology. Design thinking is the approach of solving complex problems in a human centered way. It follows cooperative, team based, and interdisciplinary processes. Tim Brown [2] mentions about three basic stages of the design thinking. Inspiration; the stage in which experiencing the triggering problem or opportunity occur. Ideation is the stage in which ideas are developed and tested. Implementation is the stage in which the new thing is presented to the market. Products can pass these stages more than once and cycle of the stages can be completed more than once. Since every stage differs from each other, applied methods have been specified to the related stage. Methods used in practical part of this study, in other words in workshops, carries the properties of the first and second stages.

Curedale’s [1] “*Design Thinking Process and Methods Manual*” is benefitted to choose the suitable methods to be applied. The author divides the methods into five subtopics. These are:

- Ice Breaking (IB): Team Building Exercises.
- Defining the Vision (DV): What we are looking for?
- Know People and Context (KPC): What is needed?
- Explore ideas (EI): How is this idea to start?
- Prototype and Iterate (PI): How can we make it better?

Below table summarizes the methods of the workshops (Table1). Methods are derived from various design thinking resources [3], [4], [5] .

*Table 1: Used methods during the workshops*

Workshop 1	Workshop 2	Workshop 3
Milestone (IB)	5 WH (DV)	5WH (DV)
Add object (IB)	Focus Group Discussion (KPC)	Group Sketching (EI)
Grouping		
635 thod (EI)		

### 3.WORKSHOP SERIES

In this study, the researcher aimed at working in a collaborative manner, he preferred to work with a team in every stages of the process such as problem definition, framing it, etc. all. Duration of the study had been limited by the course term since this study was done within the context of the course. At the end of the 2015, September works to determine the problem was begun and the study process continued till the end of December and at the end of the December study has finished. Within the scope of the course, “a day in a life method”, which was given as a submission by the lecturer, had been used to ease the determination of the problem. The results of the application of this method were mainly focused on the daily furniture used by the researcher himself. Mostly ergonomic problems of the furniture were obtained and reported by the application of the problems. At that point, the researcher noticed the challenge of generalization of the result and misleading candidates of the problems, thus he wanted to work collaboratively in determining the problem alternatives. For that reason, first workshop was organized.

#### Workshop 1

Undergraduate industrial design students of ITU made first workshop. 6 students were participated in the workshop and it took approximately 2 hours. Participants were in their 5<sup>th</sup> or upper terms, so it might be assumed that all participants had a designer approach by means of handling the problem and using methods. The researcher aimed at applying a composition of several methods for the first workshop. By usage of icebreaking methods, both warming up the environment and revealing the topics to talk about by participants was targeted. At first “Milestone” method was used. Participants were asked to mark 3 milestones of their life on the given time table by post-its. Moving to another city was one of the prominent answers. Establishing own business, marriage, earthquake, and family issues were other remarkable answers. Secondly, “Add Object” method was used. Every participant was asked to share their association about the 3 milestones, which were not written down by themselves. Because of having more answer related to moving, objects related to moving had been higher. Bus, car, luggage can be given as an example to this. Other answers were such as magnifiers, binoculars, first aid kit, orange, etc. al. Motivations behind writing these objects were argued together and their wide perspective on matching milestones and objects was revealed. For example, a participant, at first stage, had shared moving to Antalya as a milestone, another participant, at second stage, matched it with the orange, because of the city’s fame. In another example, ‘99 earthquake had been mentioned as a milestone, another participant matched the first aid kit with it. As seen in first example, milestone-object matches can be indirect and as seen in the second one can be direct. Third stage is grouping. Shared objects were tried to be grouped to set a meaningful unity or a story. “Bed,

bell, pink shades”, “magnifier, microscope, binocular”, “luggage, bell, bus” were some examples of this grouping. Grouping was done more than once at that level. Grouping similar objects or gathering different objects to form a story were two different methods applied by the participants. Before passing to another level, participants were asked to take one of the problematic objects of their life and sit down their chair. For last, “635 Method” was used. Participants were asked to write down or sketch about the problematic objects that they choose to an A5 size paper. At the beginning of this level, participants were informed to share their ideas only by writing or sketching, never by talking (Figure1).

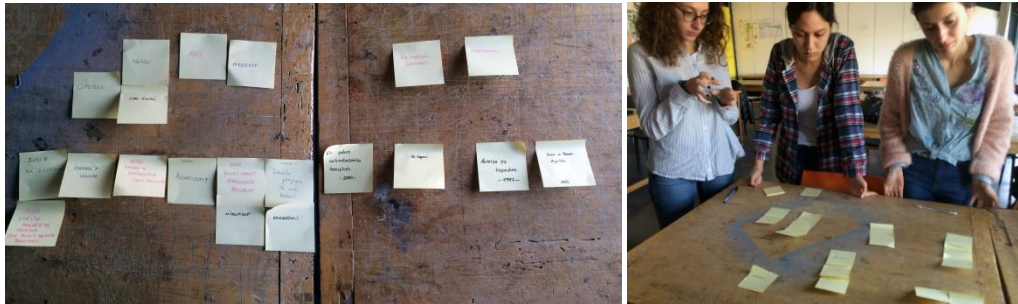

Figure 1: Workshop 1 (milestone & add object method)

After 5 minutes, every participant was asked to give his or her paper to the clockwise participant. Every participant continued to design process incrementally by using another A5 paper for their friend’s problem and after 5 minutes again transferred his / her paper to next friend. This action continued, till every participant had shared a solution on the every problem, 5 minutes long periods repeated for 6 times. 6 different problem fields were looked through and discussed. The researcher had chosen the doorbell as the problem field for the next stage. A doorbell’s qualifications like being used by almost everyone in their daily life, diversity of being used by different personas, being a passive object while used in an active action and its usage by at least two people, tangible and intangible problems related with the doorbell were some reasons for the researcher to work with this object (Figure2).



Figure 2: Workshop 1 (635 method & discussions)

After one week from the first workshop, a written feedback was asked from the participants, four of them had returned. According to the feedbacks, participants were seemed pleasant about the process and collaborative work; however they mentioned some unity problems of the process, especially between third and fourth level. In addition to that two of the participants shared their wishes to have had one or more levels to materialize their ideas.

## Workshop 2

Second workshop was organized by 10 students taking Design Thinking graduate course at 26th November 2015. Before beginning to second workshop, process, outcomes, problem field, feedbacks of the first workshop were briefly mentioned to students and the lecturers and their opinions and critiques were taken. 5WH method was tried to be applied in this second workshop. One A4 sized paper was sliced into two on its short side, and 6 separate cells were defined on its long side. In every cell, within order, below questions and explanations was placed.

- Who? (is concerned, actor, group of people, responsible,...)
- What? (action, object, transaction,...)
- Where? (place, area affected by subject, step, ...)
- When? (timing, duration, time,...)
- How? (necessary means, methods, materials, procedures, ...)
- Why?

Every participant was given one of the above-mentioned form and asked to fulfill it within the context of a ringing doorbell. Every participant was asked to transfer their form to the next participant by folding their answer and for every cell this action was repeated. In every form, in every datum were collected independently. With the help of this work, asymmetric matching of the informations was aimed and possibility of dealing with the problem without applying standard approaches was questioned (Figure3).



WHO? (is concerned, actor, group of people, responsible, ...)
WHAT? (action, object, transaction, ...)
WHERE? (place, area affected by the subject, step, ...)
WHEN? (timing, duration, time, ...)
HOW? (necessary means, methods, material, procedures, ...)
WHY?

Figure 3: Workshop 2, 5WH method

At the end of the work information about the actors of the ringing the bell action ( the one ringing and the one being rung) and place, form, time, reason of the action were gotten. Since in every form was fulfilled with different person, there was no meaningful unity, there were even funny scenarios for some forms. After this work, a focus group discussion was made with the lecturer and the other students, their opinions on both workshops and chosen topic had discussed. At first, participants were mentioned to be able to share a case by fulfilling the form on their own. This revision need noted by the researcher and applied in third workshop. To prevent the disconnection seemed in grouping of the objects in first workshop, constituting personas and directing the workshop through these personas was advised. Another important issue from the discussion was, possible linkage between cultural and human centered values and doorbell. Putting on cards to door when someone could not find the host in bairams, two different door knockers for different genders in old houses, seeing the guest off to the out of the home and welcoming guests outside of the home were shared by participants as an example. Integration of doorbells with digital technologies has formed another field. Another important gain from discussion was participant’s sharing their own experiences and problems related with the doorbell.

### Workshop 3

Third workshop was made 17th December 2015 in approximately 20 minutes. Most of the participants were the participants of the second workshop and the number of them was 10. At first, revised version of the second workshop’s form was asked to be fulfilled by the participants (Figure4). By approaching through the door and bell problem field, participants were asked to set a meaningful case by answering “who, with whom, where, when, why, how?” to find cultural and social values of the doorbell. They could answer the questions in one sentence if they wish. As a result, real and possible scenarios of our daily lives were revealed. So, qualities of doorbell, which make it a medium of social and cultural sustainability, are analyzed.



Figure 4: Workshop 3

At the end a short initial idea sketching was made. Participants were asked to create ideas and offer improvements especially on doorbells which are at outer surface of the apartments. Participants expressed themselves by words and sketches. Every data collected in all three workshops will be analyzed in a detailed way in the next part.

## 4.RESULTS OF WORKSHOPS

This Bell's being a problematic area as a result of the first workshop and asymmetric informations like users, aim of the usage, usage scenarios are tried to be visualized below (Figure5).

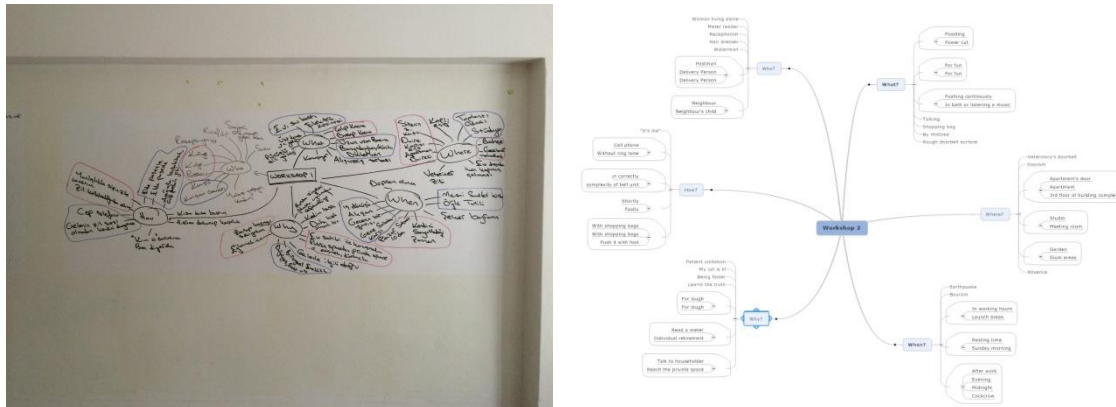

Figure 5: Results of 5WH Method in Workshop 2

Since every cell of the 5WH was completed by different people, gathered information could not form a case. As shown in the above, related answers are grouped. Although bell concept was mentioned to be handled in a broader perspective at the beginning of the study, study has been focused on the daily usage of the doorbell based on its intense usage on that field.

Number of the answers related with duration or timing is higher than others. Bell's ringing within working hours, in the evening and night, while resting are formed main grouping fields related with time. Reasons of ringing bell are seen as meter reading of electricity or water, or undesired guests like dealers or pollsters in some answers. Interface problems or problem of ringing the bell while your hands are full are the prominent answers given in "how" part. Deliveryman or neighbors are dominant answers in "who" part. Extensive usage of online marketing can be linked with the frequency of "deliveryman" as the answer. Bell's ringing while you are unavailable or fake ringing constitute another intense area.

In the focus group discussion, which was made immediately after the second workshop, participants shared experienced and potential problems of their own and talked about possible solutions on these problems. Below table summarizes this discussion. The person who interacts with bell, possible problems, and possible solutions are placed in different columns. In each rows, different scenarios are formed.

Table 2: Cases obtained focus group discussion in Workshop 2

Person	Problem	Solution
Deliveryman	Not being home	Deliveryman leaves note
Woman living alone	security	Does not fully write her name at the door
Guest visiting a family with a baby	Disturbing baby	Using whatsapp instead of the bell
Friend/ Relative	Not being able to find at home at bairam visit	Leaving a note or card
Doorkeeper	Disturbing the houseowner when he/she does not order anything	Not opening the door as if it was not heard
Guest	Not remembering your friends' door number	Making a phone at the front gate to inform the house owner.
	Accidentally pushing the wrong button	
	Kids' fake ringing	
	Tidying the house before the guest arrives	Chasing the approaching person with apps like Yandex
	Meter readers' pushing a random door number	Random button to open the front gate for everytime

Some cells in the table are intentionally left blank. Last two rows include fictional colutions. Fully filled rows are the shared scenarios of the participants (Table2).

With the help of the ideas created at focus group discussion of second workshop, third workshop has been formed. Participants were asked to constitute a sentence about a case or situation related with the doorbell by answering the questions in 5WH method. Similar elements like time/ subject/verb etc. are written with the same color in order to visualize the case.

- Daughter of the upstairs neighbour pushes our button continuously to invite the “gün”.
- I rang the bell of the lady in next door to invite her for drinking tea after the dinner.
- Mrs. Ayşe pushes the button for 2 short and 1 long time to inform her neighbor about that she was at the door before going to the public market.
- Dealers or pollsters ring my grandmom’s bell, who is living in upstairs, and she always opens.
- Water deliveryman brings the water bottle to the front door of the old lady.
- The boy playing at the street rings his own bell to want some money since his mother could not hear him.
- I ring my cousin’s door bell at the front gate, which has an interesting encoded system.
- “Bakkal Hilmi abi” tries to push the button of the doorbell while his hands are full of orders of “Halime abla”.
- Deliveryman pushes the button of the bell with his nose in the morning time while his hands are full with the boxes.

In the last part of the third workshop, which involved the sketching activity, participants were asked to share existing problems and possible solutions related with the doorbell by drawing (Figure6).

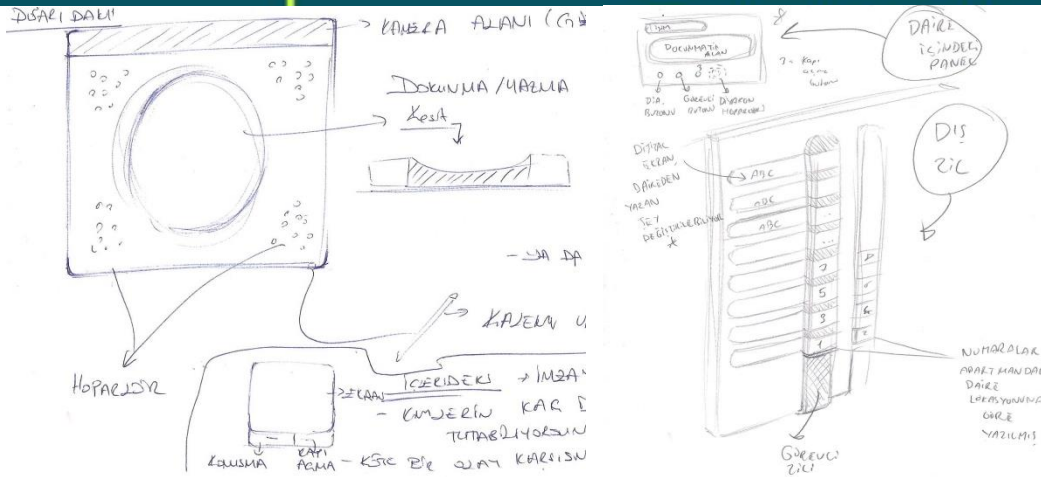

Figure 6: Initial Idea Sketches in Workshop 3

At that stage, potential solutions to current problems of the doorbell are offered. To specify these;

- With the help of integration of digital places for touching or writing onto the front gate doorbell panel, leaving a note or signing can be done with the bell.
- Front gate doorbell panel can reflect the building's floor plan in order to provide information about the number and floor of the desired apartment.
- By using apps/ cellphones guests can be seen before they come.
- Nametags at the front gate doorbell panel can be digitalized and changed by the house owner from their home.
- Visual tags can be used instead of using names.
- Bells can be controlled by the foot pedal while someone can't use her/his hand.

## 5. DISCUSSION

One of the main results of this study is that doorbells go beyond being a simple product with only one function. It starts interaction and creates primary communication between at least two people. Communication methods are specific to the cultures and societies. In example, in workshops, most of the new doorbell offerings add doorbell note taking function. This is highly related with Turk's traditional bairam visits. Another important aspect focused on the workshops is that different user groups in our daily lives also use it frequently. Elderly people, kids, friends, neighbors, and deliveryman, meter readers are mentioned as the ones who ring the bell in workshops. In general we can divide the bell ringers into two groups as the ones we know and we don't know. According to the gathered data from workshops, in some cases, it seemed that the bell carries additional meaning to the user beyond its main function. In some cases, it seemed that digital interface causes some ergonomic and usage problems. Problems based on the digitalized versions, are offered to be solved by dominantly digital improvements, here occurs a contradiction. However, improving visuality and functionality of the bell can be easier by the mediums of the digital world. Another frequent wish on bell's functions is seemed as not functioning every time. In some cases, bells that provide interaction between private and public spaces, are wanted to prevent this interaction while someone is resting or does not want to be disturbed for some reasons. Another problematic area of the bell is related with its physical being and usage. There are several ideas on being able to use the bell while someone cannot use his/her hands. In that part, some prominent and dominant aspects of problems related with the doorbell are emphasized. To sum, doorbells should carry some properties, which meet general usage tendencies and cultural values of a society.

## 6. CONCLUSION

In this study, design thinking methods and approaches are applied from problem definition to product suggestions. In first workshop problem area has been defined, in the second one study area has been narrowed down, in third workshop data have been collected systematically and productively. As a result, required data for the design stage is gathered. With the help of the results of this study, user groups can be narrowed down and persona or personas can occur. With the help of these personas, existing problem areas and solution suggestions can be narrowed down, thus basis for potential designs can be prepared within the harmony of social rules and culture of the target group. All stages of this study, which involves research processes prior to design practice, are run as a group work with the help of some specific methods. It carries the quality of a sample process for collaborative working.

## REFERENCES

- [1] R. Curedale, *Design Thinking: process and methods manual*, California: Design Community College Inc., 2013.
- [2] T. Brown, *Change by design*, New York: HarperCollins Publishers, 2009.

[3] V.Kumar, *101 Design Methods*, New Jersey: John Wiley & Sons, 2013.

[4] T. Lockwood, *Design Thinking Integrating Innovation, Customer Experience, and Brand Value*, New York: Allworth, 2010

[5] D.Spendlove, *100 Ideas for Teaching Design and Technology*, London: Continuum, 2008

#### **BIOGRAPHY:**

##### ***Ozan Soyupak***

I completed my undergraduate education in METU Department of Industrial Design in 2010. In 2013, I joined the ÖYP program and I began to work as a research assistant for Osmaniye Korkut Ata University and became a master-degree student in Istanbul Technical University Industrial Product Design Department. In 2015, I completed my master's degree program and joined the PHD program of ITU Industrial Product Design.



# Climate Change and Irrigation Management in Turkey

*Belgin Cakmak<sup>1</sup>, Zeki Gokalp<sup>2</sup>, Sedat Karaman<sup>3</sup>*

---

## Abstract

Water is, a fundamental element of life, an indispensable input of the agriculture. On the one hand irrigation improves agricultural production, on the other hand it can be harmful on the environment if the necessary measures are not taken and disrupt the natural balance. Depending on a population and water demand increases, available resources becomes limited, the amount of water used in agriculture is restricted. Climate change, in addition to natural climate changes observed in a comparable period of time, directly or indirectly alter the global atmosphere composition comprising human activity, has been identified as a result of climate changes. Greenhouse gases that cause global warming; mainly the burning of fossil fuels, the development of industry, transport, land use change is the result of solid waste management and agricultural activities. The burning of fossil fuels, reduction of forests, land-use change, agricultural activities and the development of accumulation in the atmosphere with greenhouse gases emitted by industry, is rapidly increasing. This situation leads to an increase in the earth's surface temperature. Reduction of Turkey's water resources, forest fires, droughts, may be affected by the negative aspects of climate change, soil erosion and desertification. The highest share of water use is agriculture in countries with low income levels worldwide. When irrigation efficiency high-pressure irrigation techniques applied in agriculture, irrigation water requirement is reduced and the water used in irrigation can be saving 50%. Therefore, pressurized irrigation methods are important tools in providing saving water. 74% of the total annual water used in Turkey is consumed in agriculture. Therefore, water-saving irrigation is necessary. With this aim, the expansion of the drip irrigation system is required for effective use in agriculture. In this study, climate change, the effects of climate change on Turkey and irrigation were discussed, water-saving measures are given in agriculture.

**Keywords:** Climate change, Turkey, the effects of climate change, water conservation in agriculture

---

## 1. INTRODUCTION

Water is the essential element of both human life and agricultural activities. It can significantly increase agricultural production, but may result in serious environmental problems in case the relevant measures were not taken on time. The amount of water used in agriculture is getting restricted every day together with increasing demands from the other water user sectors. Climate change also exerts a significant pressure on water resources and requires an efficient water management in agriculture.

Current global warming and unconscious irrigations create serious threats for the sustainability of water resources. Water and resultant food safety problems will reach to worldwide dimensions in near future. It is envisaged that food demand of world population will be doubled in upcoming 50 years [1]. Turkey is located right in the middle of the world and Middle Eastern countries where the most severe impacts of climate change encountered. Climate change was also pointed out as the greatest burden in front of reaching millennium development goals. Climate change-induced reductions in agricultural productions will aggravate poverty in some regions of the world [2, 3, 4, 5]

According to United Nations Framework Convention on Climate Change (UNFCCC), climate change is defined as a change of climate which is attributed directly or indirectly to human activity that alters the composition of the global atmosphere and which is in addition to natural climate variability observed over comparable time periods. Starting from the ends of 1980s, works have been done under the guidance of United Nations and other international organizations to mitigate the negative effects of humans on climate system and to reduce the pressure exerted by humans and Framework Convention on Climate Change and Kyoto Protocol (KP) were established with a broad participation. Greenhouse gasses, the primary constituents of global warming, are resulted from fossil fuel burnings, industrial activities, transportation and land use changes. Such cases also increase surface temperatures of the world [6].

Considering the water uses of world countries based on their income levels, it was observed that the amount of water used in industry varied between 10-59% (Figure 1). In low income countries, agriculture is the greatest water user sector and industry takes place the agriculture in developed high income countries. Irrigation is the greatest water user in agriculture and pressurized irrigation systems significantly reduce water use in irrigations and may provide about 50% savings [7, 8].

---

<sup>1</sup> Ankara University, Agricultural Faculty, Department of Agricultural Structures and Irrigation, 06360, Dışkapı/Ankara, Turkey.  
[Belgin.Cakmak@agri.ankar.edu.tr](mailto:Belgin.Cakmak@agri.ankar.edu.tr)

<sup>2</sup> Corresponding author: Erciyes University, Agricultural Faculty, Department of Biosystems Engineering, 38039, Melikgazi/Kayseri, Turkey.  
[zekigokalp@yahoo.com](mailto:zekigokalp@yahoo.com)

<sup>3</sup> Gaziosmanpaşa University, Agricultural Faculty, Department of Biosystems Engineering, 38039, Tasliciftlik/Tokat, Turkey.  
[skaraman@gop.edu.tr](mailto:skaraman@gop.edu.tr)

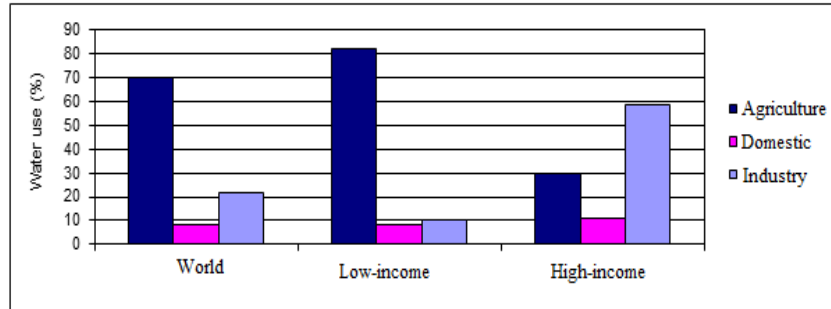

Figure 1. Water use of different sectors

Agriculture is the greatest water user sector in Turkey. Therefore, water saving technologies should be pointed in agricultural irrigations. Surface irrigation methods with quite low water use efficiencies are still widely used in Turkey. Therefore, works should be done to widespread water-saving pressurized irrigation systems. In this way, negative impacts of climate change on water resources and irrigation may be mitigated.

In this study, initially brief information was provided about the climate change. Then the impacts of climate change on water use in agriculture and irrigation management were discussed and finally recommendations were provided for efficient water use in agriculture.

## 2. CLIMATE CHANGE STRATEGY DOCUMENT AND WORKS DONE IN TURKEY

The United Nations Framework Convention on Climate Change (UNFCCC) and its Kyoto Protocol (KP) are the most significant and the only international initiations to prevent greenhouse gas emissions and to mitigate negative impacts of humans on climate system. UNFCCC aims the mitigation of greenhouse emissions, prevention of climate change and mitigation of negative impacts of climate change along with common but different national or regional development priorities, objectives and specific conditions of the countries and assign common responsibilities to the countries on these issues. Turkey completed required official processes and signed the UNFCCC ON 24 May 2004. A Coordination Board on Climate Change (CBCC) was established in Turkey for efficient performance of climate change-related national works. There are 8 working groups established under the coordination of this commission. These are:

1. Study on the Impacts of Climate Change
2. Inventory of Greenhouse Gas Emissions
3. Mitigation in Industry, Housing, Waste Management and Service Sectors
4. Mitigation in Energy Sector
5. Mitigation in Transport Sector
6. Land Use, Land Use-Change and Forestry
7. Policy and Strategy Development
8. Education and Awareness Rising of Public

Turkey, aware of serious environmental and economic impacts of climate change, prepared a national climate change strategy document for the period covering 2010-2020 to mitigate the effects of climate change and for adaptation to climate change. The primary measures to be taken in land and water use to mitigate greenhouse gas emissions are summarized in Table 1.

Table 1. Primary measures to be taken in land and water use to control greenhouse gas emissions (Anonymous, 2010)

Short term	Medium term	Long term
Rational fertilizer use will be promoted	Crisis management will be implemented based on agricultural drought forecasts	A central geographic information system shall be established for all land use classes in Turkey in order to prepare the Greenhouse Gas Inventory and National Inventory Report in line with guidelines from the Intergovernmental Panel on Climate Change (IPCC), and a monitoring model will be developed based on stand maps and satellite data in order to calculate changes among land use classes
carbon emissions will be limited by using modern techniques for irrigation, soil cultivation, pesticide use, etc.	Classification standards on protection, improvement and efficient use of soil and land will be developed and practices will be monitored and lands will be used consistent with their capability classes	Forest lands and forestry activities, which are crucial for protection and management of water resources within the framework of sustainability principles, shall be planned and implemented based on upper basin management principles
organic agriculture, drought-tolerant plants and certified seed production will be supported and expanded	The Law on Soil Protection and Land Use shall be efficiently implemented and enforced, appropriate secondary legislation shall be introduced	Increasing open green space systems in urban areas shall be encouraged and urban forestry shall be improved
Producers will be financially and technically supported for their measures on conserving irrigation water and decreasing costs in the irrigation investments	Measures will be taken for wastewater collection and reuse of treated wastewater in agriculture and industry	
Establishment of modern in-farm pressurized irrigation systems (drip / sprinkler irrigation systems) shall be encouraged.	Research and development activities shall be accelerated in support of the combat against drought	
Technical and financial studies will be carried out on land consolidation to facilitate provision of on-farm services		

The other measures to be taken to improve adaptation capacity of Turkey to climate change can be organized as follows:

*Short term:* Activities shall be accelerated for enhancing water quality that has been degraded due to the negative impacts of climate change. Activities on combating desertification and erosion will be developed and expanded. Scientific studies on the sustainable use of natural resources will continue, taking into consideration the interaction between climate change and sectors.

*Medium term:* Water legislation shall be improved and the concept of adaptation to climate change shall be integrated into the legislation. River basin master and management plans for 25 river basins shall be developed within the scope of development, multi-purpose usage and protection of all ground and surface water resources in Turkey. Early warning systems for flood disaster reduction shall be developed and existing flood risk maps in all watersheds shall be updated. Agricultural practices that account for the adverse impacts of climate change on water resources shall be developed to ensure the sustainability of agricultural production. Projects will be developed and farmers will be trained on measures to prevent the increase in the

salinity levels in irrigation areas within the regions where heat and evaporation will rise due to climate change (e.g., soil cultivation, drainage, irrigation, and mulching). Natural disasters such as floods, avalanches and landslides, frequency of which are expected to increase with climate change, shall be identified and necessary activities shall be initiated in order to minimize the impacts of these disasters, through the use of early warning systems. Financial assistance shall be provided in order to improve the capacity in crop productivity projections carried out based on the data on climate, land use and vegetation density, with the aim of monitoring the impacts of drought.

*Long term:* Studies will be carried out on volume-based water pricing to ensure protection and efficient use of water resources. Irrigation networks which cause excessive water consumption and/or have completed their economic life spans shall be rehabilitated and/ or replaced by modern systems, and relevant projects will be supported. Efficient use of wastewater shall be promoted in urban green areas. Drought Test Centre will be established in order to develop and test drought- tolerant crops. Mechanisms to facilitate public access to risk maps and disaster management plans relating to climate change shall be developed. Within the framework of adaptation to climate change; agricultural basins will be identified and basin-based production will be performed for sustainable agriculture, efficient production planning and greater productivity. Rainwater capture, use, and recycling strategies shall be developed for settlements and buildings, including the introduction of new technologies [9].

### 3. CLIMATE CHANGE AND IRRIGATION MANAGEMENT

Climate change-induced water problems have emerged in various parts of Turkey since the beginning of 2000s. The problem is more distinctive in agricultural sector trying to meet the food demands of ever-increasing population. Turkey is faced with continuous drought threats. The latest serious drought was experienced in 2007. In a drought analysis carried out for entire Turkey by using standard precipitation index (SPI) and percentage of normal index (PNI), it was indicated that Turkey experienced the most severe drought event of the last 37 years [10]. Turkish organizations dealing with water and agriculture put significant emphasis on efficient water use in adaptation to climate change. Agriculture consumes about 73% of total fresh water resources in Turkey. The development plants after the tenth one (2014-2018) are toward to improve water use efficiencies in agriculture. The program targets to improve water use efficiency in agriculture at national and basin level through solving water-related problems and preventing excessive water uses (Table 2). Climate change will definitely affect water cycle and agricultural demands and will make the water resources deficit especially in arid and semi-arid regions. Effects of climate change on water supply and demand in agriculture are provided in Table 3. Adaptation options to climate change should assess investments, management compliance, changes or policies, institutions and capacity development together. All these options should be assessed and implemented at different national and basin levels. The effects of these options at different levels are provided in Table 6 [11].

Table 2. The action plant for efficient water use in agriculture [12]

Program targets	To increase the ratio of the lands over which modern water-saving irrigation techniques are applied (drip and sprinkler) in total irrigated lands from 20% to 25% during the planned period.
	To increase irrigation ratio from 62% to 68% and to increase irrigation efficiency from 42% to 50% during the planned period.
	To increase number of modern irrigation systems by 10% in every year of the planned period.
	To reduce groundwater uses by 5% during the planned period.
Performance indicators	Irrigation efficiency
	Irrigation ratio
	The size of lands irrigated with modern irrigation systems
	Groundwater uses
	Number of farmers participating in irrigation trainings
	Number of drought resistant species
	Size of consolidated lands
	Budget sufficiency ratios of irrigation organizations
Nitrate pollution in surface and groundwater resources	
Program components	Modern and efficient irrigation infrastructure
	Training and extension services for conscious water use
	Support policies
	Basin-scale water budgets
	Efficient organizational structure
Coordinator and responsible Institutions /Organization	1 <sup>st</sup> component: The Ministry of Forestry and Water Affairs
	2 <sup>nd</sup> component: The Ministry of Food Agriculture and Livestock
	3 <sup>rd</sup> component: The Ministry of Food Agriculture and Livestock
	4 <sup>th</sup> component: The Ministry of Forestry and Water Affairs
	5 <sup>th</sup> component: The Ministry of Forestry and Water Affairs

Table 3. Climate change and development: how they influence water supply and demand [11]

Elements of the water cycle	Impact from	
	Development activities	Climate change
Annual precipitation	No or minor impact	Expected to increase globally during the 21st Century, with potentially great spatial variations
Inter-annual variations in precipitations	No impact	Expected to increase everywhere
Seasonal variability of rainfall	No impact	Expected to increase everywhere
Soil moisture stress (droughts)	Limited impact: some agricultural practices can deplete soil moisture faster than natural vegetation.	Moisture stress to generally increase as a result of increasing variability of rainfall distribution (longer periods without rain) and increasing temperatures
Floods	Moderate impact: flood intensity and impact can be exacerbated by changes in land use and unplanned development in alluvial plains.	Increased as a result of increasing frequency and intensity of extreme rainfall events
Snow and glacier melt	Limited impact through deposit of pollutants and change in the reflecting power of the surface (albedo).	Rising temperatures lead to accelerated snow and glacier melt with initial increases in river flow followed by decreases.
River discharge	High impact in water scarce areas, where reservoir construction and water diversion for agriculture and other uses are modifying runoff regimes and reducing annual flow. Large-scale water conservation measures also have an impact on river discharge	Increased variability as a result of changes in rainfall patterns. Changes in snow and glacier melt induce changes in seasonal patterns of runoff. Changes in annual runoff expected to vary from region to region
Groundwater	High impact: large-scale development of groundwater resources in many regions are already threatening the sustainability of aquifers in many dry areas	Varies as a function of changes in rainfall volumes and distribution. Impact is complex, with floods contributing to increasing recharge, and droughts leading to increased pumping.
Evapotranspiration	Limited impact in agriculture: some crops have higher evapotranspiration rates than natural systems, other less	Increases as a function of temperature increases.
Water quality (in rivers, lakes and aquifers)	High impact from pollution in highly developed areas	Moderate impact through temperature increases.
Salinity in rivers and aquifers	High impact from water withdrawal in highly developed areas (mostly in arid regions)	Potentially high impact where sea water level rise combines with reduced runoff and increased withdrawal.

#### 4. CONCLUSION AND RECOMMENDATIONS

Climate change will have the most devastating impacts on agriculture. For agriculture, the greatest concern in climate change-induced droughts. Water is the most significant source of food safety, therefore food safety is also under threat. Sufficient food supply to feed increasing world population depends on temporal and spatial distribution and the amount of water available for food production.

Developing countries, like Turkey, use majority of their fresh water resources in agriculture. Water loss is the greatest problem in agricultural water uses. Therefore, water saving should be initiated from the agriculture and efficient water use should be supplied. Measures should be taken to save water in combating with climate change. Such measures may include the use of water-saving technologies, use of pressurized irrigation systems (drip and sprinkler) instead of surface gravity irrigation

methods, water deficit applications in irrigations, use of water harvesting techniques, re-use of treated wastewaters, use of piped delivery and distribution systems instead of open canal systems. Adaptation strategies can be implemented for climate change. Cooperation among responsible organizations and institutions should be developed for better implementation of such adaptation strategies.

## REFERENCES

- [1] Anonymous, Water for Food Water for Life. A Comprehensive Assessment of Water Management in Agriculture. Edited by David Molden, International Water Management Institute.645p., Earthscan, USA, 2007.
- [2] B. Çakmak, Z. Gökalp, İklim Değişikliği ve Etkin Su Kullanımı. Tarım Bilimleri Araştırma Dergisi 4 (1): 87-95, 2011.
- [3] B. Çakmak, Z. Gökalp, Tarımda Su Kullanımı ve Su Tasarruf Teknikleri. 3. Ulusal Toprak ve Su Kaynakları Kongresi, 22-24 Ekim, Tokat:733-741.Tokat poster, 2013a.
- [4] B. Çakmak, Z. Gökalp, Kuraklık ve Tarımsal Su Yönetimi. Gaziosmanpaşa Üniversitesi Fen Bilimleri Enstitüsü Gaziosmanpaşa Bilimsel Araştırma Dergisi. Sayı: 4, Sayfa: 1-11. Tokat, 2013b.
- [5] B. Çakmak, Z. Gökalp, B. Kendirli, Sürdürülebilir Tarımsal Su Yönetimi. 3.Uluslararası Bursa Su Kongresi ve Sergisi, Merinos Kültür Merkezi, Cilt:1, s.110-118, Bursa, 2013.
- [6] Anonymous, İklim Değişikliği Özel İhtisas Komisyonu Raporu Sekizinci Beş Yıllık Kalkınma Planı. DPT: 2532 . ÖİK: 548, 123 s. Ankara, 2001.
- [7] D. Seckler, The New Era of Water Resources Management: From “Dry” to “Wet” Water Savings.IIMI Research Report 1,17p., Sri Lanka, 1996.
- [8] A.I. Shiklomanov, World Water Resources “A New Appraisal and Assessment for the 21<sup>st</sup>Century”.Unesco Publications 37p., Paris, 1998.
- [9] Anonymous, Türkiye Ulusal İklim değişikliği Strateji Belgesi 2010-2020. Çevre ve Orman Bakanlığı İklim Değişikliği Dairesi başkanlığı.16s, 2010.
- [10] O. Şimşek, M. Asar, B. Çakmak, 2006-2007 Tarım Yılıının Kuraklık Analizi. Kuraklık ve Su Yönetimi Toplantısı Bildiri Kitabı. 15-16 Mayıs 2008 5.Dünya Su forumu Bölgesel Hazırlık Süreci Türkiye Bölgesel Su Toplantısı. Çevre ve Orman Bakanlığı DSİ Genel Müdürlüğü V.Bölge Müdürlüğü, s.199-213, Ankara.
- [11] Anonymous, FAO, Climate-Smart Agriculture Source Book. Food and Agriculture Organization of the United Nations, 2013.
- [12] Anonymous, K.B. Tarımda Su Kullanımının Etkinleştirilmesi Programı Eylem Planı. Onuncu Kalkınma Planı 2014-2018. Program Koordinatörü Orman ve Su İşleri Bakanlığı.16s, 2014.

# Form Balcony to French Window: Effects of Urban Transformation on Local People of Suadiye and Bostancı Districts

Ilayda Soyupak<sup>1</sup>

---

## Abstract

*This paper aims to discuss the effects of urban transformation on local people of Suadiye and Bostancı Districts in Kadıköy - İstanbul regarding people's life styles, habits, and relation with built environment. After the 17th August 1999 earthquake, the government has supported urban transformation for risky and dangerous buildings even in some cases for the whole of a district. As a result of this support, especially more profitable districts have undergone a rapid environmental change. Suadiye and Bostancı are the two examples of this situation. In this paper, general characteristics of urbanization and urban transformation and their relation with the socio-cultural sustainability in the Suadiye and Bostancı are analysed by design thinking methods. In order to understand the governmental aspects of urban transformation, at first urban transformation laws are expressed briefly. After the brief explanation, effects of urban transformation on local people are discussed. The discussion is supported by the observations, desktop research, self-experiences and literature review. The discussion is especially focused on the shift from the balcony to French windows because of implicit and explicit meanings of the balcony. Consequently, environmental stress depending on the urban transformation on local people of Suadiye and Bostancı is emphasized and concerns about the losing certain cultural values of the districts are shared.*

**Keywords:** Urban Transformation, Environmental Stress, İstanbul

---

## 1. INTRODUCTION

This research is a continuation and evolved version of a previous study, which has been prepared within the context of Environment Behavior Theories Course, which is one of the graduate level courses of ITU Architectural Design PHD Program, for 2015-2016 Fall Semester. As part of the course, participants, including me as the author of this paper, were asked to study on the traces found on both human behaviors and environment by considering the intersection of socio-behavioral phenomena, place and people at present time. According to the given task, Suadiye and Bostancı districts have been determined as the "place", local people have been chosen as the "people", transformation of open spaces of the buildings from the form of balcony to French window has been put as the "socio-behavioral phenomena". Here, transformation of open spaces of the buildings from the form of balcony to French windows could be seen as an element related solely with the form of the buildings and its visual characteristics. However, for the determined area, for local people this spatial transformation in their home means a change in their relation with the outer environment, and thus indicates changes in their behaviors dependent upon their environment. This study aims to discuss the effects of urban transformation of the determined districts on the local people focusing on the environment and behavior relations and socio-cultural sustainability.

In order to state a clear discussion, this study has been divided into three main parts. In the first part, general characteristics of the determined place and people are mentioned with an urban transformation centered manner and urban transformation laws are briefly mentioned. In the second part, the discussion is structured around the previously expressed data and the analysis of the current urban transformation of the districts, which is made by self-observations and application of suitable theories. In the third part, environmental transformation of the districts and behavioral change of local people will be analyzed within the context of socio-cultural sustainability.

## 2. GENERAL CHARACTERISTICS OF URBANIZATION AND URBAN TRANSFORMATION IN SUADIYE AND BOSTANCI

In this part, general information about the Suadiye and Bostancı districts and their inhabitants, the reasons behind the urbanization process of the area, and legislations related with the urbanization process in the area are expressed briefly.

Understanding urbanization process of the districts is important to understand the effects of urban transformation specific to them. Urban transformation is a redesign action on urban scale. Although physical dimensions of the two are very different, there are many similarities between redesigning of a product and redesigning an area. Both of them require analysis of the existing conditions, require defining the new problems, and require correct market analysis. After redesigning a product, manufacturers expect to increase sales rate and profit while preserving and pleasing their old customers. Similar to it, in urban transformation, contractors expect to increase number of apartments that they sold and their profit while preserving and

---

<sup>1</sup>Corresponding author: Marmara University, Department of Interior Design, 34660 Kadıköy / İstanbul. [ilayda.karabatak@marmara.edu.tr](mailto:ilayda.karabatak@marmara.edu.tr)



pleasing the old inhabitants. After redesigning a product, loyal customers expect to experience their product in a similar way as in the previous version of the product. Similar to it, after urban transformation, local people expect to experience their environment in a similar way as in the previous version of it. Obviously, there are certain differences between redesigning the product and redesigning the environment in terms of their impact range depending the scale of the redesign act. However, these differences are ignored now to transmit the general information about the districts more comprehensively.

Depending on the similarities between redesigning a product and urban transformation, 5WH method, which is an old journalism method and counted as a design thinking method, is applied to understand the general characteristics of urbanization process and urban transformation process in Suadiye and Bostancı (Table 1). Information shown in the table and summarized here is derived from the master thesis of Arıkan, who studied the urban space transformation in Feneryolu [1]. The answers of the question “when”, show the important dates in the urbanization process of the districts. There are six periods of urbanization process in Suadiye and Bostancı. These are determined according to drastic environmental and social changes, governmental regulations and separated as “Early 1900s, 1930s - 1964, 1965-1973, 1973-1985, 1985-early 2000s, 2000s-now”. The answers of the question “why”, explain why these dates are important for the urbanization process of the districts. In early 1900s period, two main roads, the railway and seaway transportation developed. In 1930s-1964 period, increasing population and parceling the large grounds occurred, new development plan law prohibited usage of wooden structure, 13.11.1952 dated, 1/2000 scaled Bostancı--Erenköy plan limited height at 12.5 meters. In 1965-1973 periods, property ownership law and related legal regulations permitted building apartments up to 12.5 meters and apartment houses has begun to emerge. In 1973-1985 period, 25.04.1973 dated, 1/5000 scaled development plan did not limit the height of the building, it determined the height by “TAKS” and “KAKS”, in other words by floor area ratio. In 1985-early 2000s period, 08.1985 KAKS was increased from 1,8 to 2,07 (higher apartments) and By 1990 regulations open and closed attachments were included into the construction field. From 2000s to now, after 1999 earthquake, urban transformation rate has increased and in 11.05.2006 dated development plan net construction square meters has been increased. The answers of the question “who” indicate the general position of the inhabitants in social strata. In Early 1900s period, inhabitants of the districts were from upper and upper middle class. In 1930s -1964 period, they were from upper middle class and middle class,. In 1965-1973; 1973-1985 and 1985-early2000s periods, they were from middle class. However, this has begun to change after 2000 to upper middle class and middle class. The answers of the question “where” defines the place that people lived. From 1st to 6th period, places that people lived are in order: wooden mansions, concrete single houses, concrete 4 floored apartments, concrete 4-8 floored apartments, high rise apartments, high(er) rise apartments. The answers of the question “what”, informs us about the general properties of the residential areas. In 1st period, houses had large gardens, away from the streets and almost all of them served as summer mansions. In 2nd period, houses have smaller gardens, closer to streets and used as summer mansions and permanent residences. In 3rd period, houses had very small gardens, served for permanent living and had direct interaction with streets via balconies. In 4th period, houses had smaller gardens, backyards as car parks, and direct interaction with the street via balconies. In 5th period, houses had larger car parks, decreased balcony areas. In 6th period, houses have had bigger car parks, and lost the balconies and french window has been used to serve like a balcony. The answers of the question “how” shows us the ways of interaction between people and environment. In 1st and 2nd period, local people had spent time in gardens, beaches and gotten together in the commercial center of Kadıköy. In 3rd and 4th period, people worked in closer districts, spent time in coastal road, summer cinemas and in balconies. In 5th period, people worked in both close and further areas and spend time in coastal roads, city centers, other districts. In 6th period, people have worked in both close and further areas and spend time in both inner and outer environment with new technological devices. As mentioned, there have been certain changes between from a period to another one, in terms of general characteristics of the people, houses and lifestyles.

Table 5. 5WH of urbanization in Suadiye and Bostanci

WHEN	Early 1900s (1900s-1930s)	1930s-1964	1965-1973	1973-1985	1985-early 2000s	2000s- now
WHY	Two main roads, the railway and seaway transportation developed	*Increasing population and parceling the large grounds *New development plan law prohibited usage of wooden structure *13.11.1952 dated, 1/2000 scaled Bostanci-Erenköy plan limited height at 12.5 meters	*Property ownership law and related legal regulations permit building apartments up to 12.5 meters *Emergence of apartment houses	*25.04.1973 dated, 1/5000 scaled development plan does not limit the height of the building, it determines the height by "TAKS" and "KAKS", in other words by floor area ratio	*08.1985 KAKS is increased from 1,8 to 2,07 (higher apartments) *By 1990 regulations open and closed attachments are included into the construction field	*1999 earthquake *in 11.05.2006 dated development plan net construction square meters is increased.
WHO	*Upper middle class *Upper class	*Upper middle class *Middle class	*Middle class	*Middle class	*Middle class	*Upper middle class *Upper class
WHERE	Wooden mansion	Concrete single house	Concrete, 4 floor apartment houses	*Concrete, 4-8 floor apartments	*High rise apartments	*High(er) rise apartments
WHAT	*Large gardens *Summer mansions *Away from the streets	*Smaller gardens *Summer mansions and permanent houses *Closer to streets	*Very small gardens *Permanent houses *Direct interaction with the street via balconies	*Smaller gardens *Backyards as car park *Direct interaction with the street via balconies	*Bigger carparks *Decreased balcony areas	*The Biggest car parks *French windows, absence of balconies
HOW	*Spend time in gardens, beaches *Get together in the commercial center of Kadıköy	*Spend time in gardens, beaches *Get together in the center of Kadıköy and local cafes	*Work in closer districts *Spend time in coastal road, summer cinemas *Spend time in balconies	*Work in close districts *Spend time in coastal road, summer cinemas *Spend time in balconies	*Work in both close and further areas *Spend time in coastal roads, city centers, other districts	*Work in both close and further areas *Spend time in both inner and outer environment with new technological devices

The below elevations (Figure1) [1], belonging to the Feneryolu districts, can be helpful to demonstrate the urbanization process of Suadiye and Bostanci.

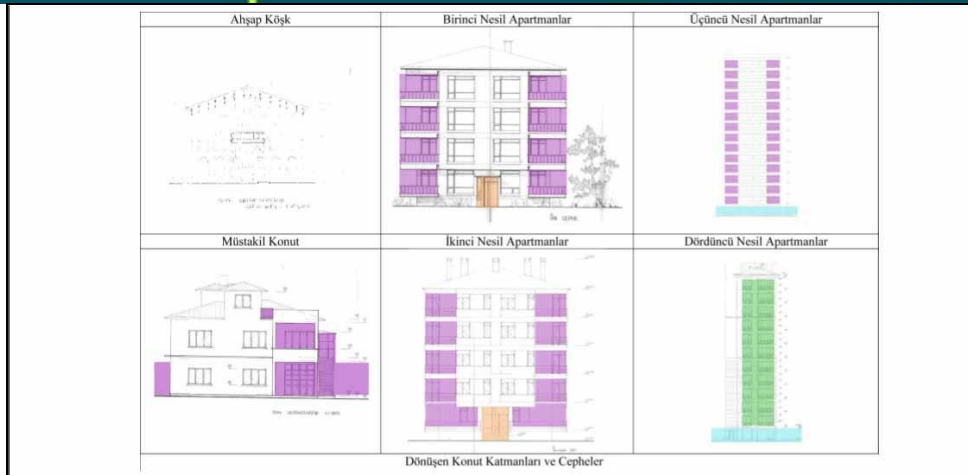

Figure 18. Transformation in facades of houses in coastal districts of the Kadıköy

### 3.EFFECTS OF URBAN TRANSFORMATION ON LOCAL PEOPLE OF SUADIYE AND BOSTANCI

This discussion part is separated into two parts. In the first part, effects of current urban transformation in the Suadiye and Bostancı are tried to be analyzed based on the self-observation of the author. In the second part, findings and observations of the author is evaluated based on the environment-behavior theories and socio-cultural sustainability.

#### Traces of Urban Transformation

To find the traces of urban transformation in Suadiye and Bostancı districts, as being an inhabitant, the author has searched the area on foot. The author has chosen to study this issue based on her experiences. In that sense, this study is a reflection of her awareness with the surrounding environment. The study begins with the quest for her neighbor.

When the building opposite of the author's apartment dealt with a constructor and the new building has arisen, the author realizes that there is not any balcony in the new building. (Figure2) Old building was an apartment with two floors and two large balconies at facade. House owners were two siblings and had owned the house from its first construction. So, they were well adapted to the environment, their daily life in home had been shaped according to their house. They were prone to live in their balconies in a Mediterranean way for every season. Thus, new form of the transformed building has not fit the old habits of the neighbor. They could not find a chance to sustain their daily routine, their way of communication in the new apartment.



Figure 19. Neighbor of the author with their new house

Before the transformation, the author used to see her neighbors almost any time when she comes and goes to her apartment. She interacted with them and involved in their lives via their balconies. However after transformation, she realized she had never seen her or talked with her. The author has realized that her neighbors were trying to follow their old habits coming from their balconies in front of the French windows. Putting flowerpots, hanging laundries, two chair and one coffee table in front of the window to see the street can be counted as the old traces in the new building. Thus, author has begun to search for the meanings of balconies in old apartments, tried to identify if the transformed buildings supply any places to transfer the meanings of the balconies. Below pictures exemplifies the different functions and attributed meanings of the buildings with balconies (Figure3).



Figure 3. Different functions of balconies in Suadiye and Bostanci districts

As shown in Figure3, balconies are used for eating, cooking, hanging laundry, storage, mobility and they are also used for reflecting self identity, shaping interaction between inside and outside. So, balcony becomes a cultural medium for its owner. It gives clues on daily routine of the owner and his/her way of thinking and living. However, the author realizes that old inhabitants could not find a place for continuing their old habits linked with the balconies (Figure4).



Figure 4. Buildings after urban transformation

## Meaning of traces

If we are to examine the topic of this study, we see that transformation of balconies to French windows is specifically emphasized. The reason behind it that, balconies are the intersections of home and the surrounding environment. Thus so, it becomes an interface for reflecting the self-identity of the house owner to the environment and an interface for environment and society to the house owner. However, extinction of the balconies in new high-rise apartments causes a system failure in this interface. In terms of environment and behavior studies, this situation originates sudden changes in behavioral settings, person-environment fit, and identity. All of these aspects cause cultural change for the inhabitants.

As it mentioned before, houses in Suadiye and Bostanci districts have characteristics of the summer resorts with respect to its historical roots and being a coastal region. These characteristics have been adapted to the buildings from the different stages of urbanization process in Suadiye and Bostanci till now. Since the urbanization process of the districts is young and construction of the first multiple floor apartments is younger, Mediterranean way of life is inherited from the older urbanization stages. Populations of the house owners are constructors and alive witnesses of the urbanization process in the districts. So they developed certain behavior settings in balconies. Based on the Barker's [2] definition of behavior settings as its being a medium for achieving multiplicity of satisfactions, we can say that new buildings make the old house owners unsatisfied because of losing a behavior setting. At that point, operations related with the balconies are tried to run in front of the French windows or in houses or similar to it emotional attachments to balconies are tried to be made with the new house, and so

person-environment fit ratio changes. If we apply PE fit theory that Caplan [3] explained, when the old house owner contact with a new apartment, which is designed for the future inhabitants, degree of adjustment of the old house owner should be expected at a lower level comparing to his/her old house.

As it has been seen in the figures, people are using their balconies to reflect their ideas, they hang flags, put posters or objects to express themselves, etc. As the dwellings and domestic objects cast implicit, non-verbal meanings about the owner's identity or social group [4], balconies function as a medium for expression of one's self to the surrounding environment. So, in new houses, this medium has been broken. So, sustainability of the local culture has been interrupted. To conclude, traces found with observations, indicate negative trends in environment and behavior relation and cultural sustainability of the old inhabitants of the Suadiye and Bostanci.

#### 4.CONCLUSIONS

This study is generally structured on the tacit knowledge and observations of the author and tried to be supported by basic theoretical works in the immense field of environment and behavior studies. Effects of urban transformation in Suadiye and Bostancı districts on local people are discussed by focusing on the transformation of balconies. Loss of personal identity reflected through the balconies, not fitting the new environment, tension in behavior patterns are asserted as the possible negative impacts which are highly related with the cultural sustainability of the local people. However, this study should be continued with a comprehensive fieldwork and enriched in terms of theoretical background.

As a result, although this study is a sketch of a comprehensive research, highlighting the reckless urban transformation in the districts is valuable.

#### REFERENCES

- [1] Arıkan, "Transformation Of The Urban Space And Stratification In The Housing Stock: The Case Of Feneryolu Neighborhood", M. thesis, Istanbul Technical University, Institute of Physical Sciences, Istanbul, Turkey, March 2013 .
- [2] R. Barker, "Behavioral Settings: Defining Attributes and Varying Properties", in *Ecological Psychology: Concepts and Methods for Studying the Environment of Human Behavior* Stanford, Ca: Stanford University Press., pp:183-193, 1968
- [3] R.D. Caplan, "Person-Environment Fit Theory and Organizations: Commensurate Dimensions, Time Perspectives, and Mechanisms", *Journal of Vocational Behavior*, vol. 31, pp.268-267, 1987.
- [4] D.M. Hummon, "House, Home and Identity in Contemporary American Culture", in ed. S. L. and ed. E. C. in *Housing, Culture and Design*. Philadelphia: University of Pennsylvania Press, 1989.

#### BIOGRAPHY:

##### *İlayda Soyupak*

I completed my undergraduate education in METU Department of Industrial Design in 2010. In 2012, I joined the ÖYP program and I began to work as a research assistant for Düzce University and became a master-degree student in Marmara University Interior Architecture Department. In 2015, I completed my master's degree program with a thesis named as "Interaction between Furniture Design and Child Psychology". I continue to Doctorate in Art Program in Marmara University Interior Architecture Department and am trying to specialize in environment and behavior relations regarding children.

# Phosphorus Losses Influenced by Irrigation Efficiency, Tillage, and Phosphorus Rate

Osman Sonmez<sup>1</sup>

---

## Abstract

Phosphorus (P) additions are necessary for plant growth and livestock production. However, eutrophication problem might be happened due to excess losses of P from agricultural lands to watersheds. Therefore, implementation of management practices that minimize erosion and runoff plays a crucial role in P transport. In order to investigate the effects of irrigation efficiencies (40% and 60%), P rates (0, 90 and 135 kg ha<sup>-1</sup>), and tillage (conventional-till, and Chisel-till) on P losses in runoff water from furrow irrigated cotton fields at two different locations (Eyyubiye and Koruklu). Sediment losses, runoff volume and P were summed over the growing season. Significant interaction between tillage and irrigation efficiency for runoff volume in 2009 were found in both locations. Runoff volume was generally highest with low irrigation efficiency (40%) and Chisel-till. Similar interaction was also found for sediment losses in 2009 at Koruklu location as well as in 2010 at Eyyubiye location. Generally the highest sediment losses were with Conventional-till and lower irrigation efficiency, whereas the lowest ones were with Chisel-till and higher irrigation efficiency (60%). Phosphorus losses significantly increased with increasing P rate and decreasing irrigation efficiency. For example, P losses in 2010 for Eyyubiye location were ranged from 132.4 to 1298.6 g ha<sup>-1</sup> for total P, 60.4 to 293.2 g ha<sup>-1</sup> for water soluble P, 83.7 to 716.2 g ha<sup>-1</sup> for bioavailable P. The highest P losses were with low irrigation efficiency and conventional-till, whereas the lowest ones were with high irrigation efficiency and Chisel-till. Overall, the results suggested that increasing P rate increased P losses but no effects on sediment losses and runoff volume which were accelerated by conventional-till and low irrigation efficiency.

**Keywords:** P losses, P runoff, Eutrophication, Tillage, P transport.

---

## 1. INTRODUCTION

Sufficient soil phosphorus (P) is important for achieving optimal crop production. In the year of application, the efficiency of P fertilizer is limited (20%), and a remaining 80% of applied P becomes unavailable to plants because of precipitation or adsorption of P with ions depending on soil pH and mineralogy [1]. As a result, only a relatively small fraction of soil P is available to plants. When there is an insufficient soil solution P, application of inorganic and/ or organic P fertilizers becomes necessary for optimal crop production. However, during the last century excessive P application has elevated soil test P (STP) to a level higher than plant needs. Increasing soil P can accelerate the risk of P loss by erosion, overland flow and leaching, promoting eutrophication of surface waters. These contrasting issues necessitate to manage P in a judicious manner (e.g., [2], [3]).

In the USA and Europe last decades, P losses from agricultural area to large water bodies like rivers and lakes became a major research subject for scientists to study eutrophication. They declare that P losses in runoff from agricultural field should be limited as a means of protection from eutrophication [2].

South East Anatolian Project in Turkey is the most important integrated project covering Harran Plain with the total area of 225,000 ha and irrigated area of 152,000 ha. When the plain having potential of high agricultural production faced the irrigation facilities, the agricultural production increased sharply. However, most of the drainage channels in the area have been filled with sediment carried by runoff because of excessive irrigation. Therefore, P losses in runoff from agricultural field in the plain have also become unavoidable due to some agricultural practices such as over-irrigation, excessive P application and heavy tillage.

The objectives of this study were to investigate the effects of tillage and P rate on P losses in runoff water from free irrigation at two different irrigation efficiencies on cotton.

## 2. MATERIAL AND METHODS

This study was conducted in two different locations (Eyyubiye and Koruklu) in Şanlıurfa-Turkey from 2009 to 2011 on clay soils. Soil sample were taken before planting and after harvest. Some physical and chemical soil properties were given in table 1. Tillage treatments including conventional-till (CT), and Chisel-till (ChT) in combination with P treatments as, (control (0), suggested (90 kg ha<sup>-1</sup>) and over dosage (135 kg ha<sup>-1</sup>)), and free irrigation at two different irrigation efficiencies (40% and 60%). The experimental design was a split-split plot with three replications. Main plot (9 x 15 m), subplot (5 x 9 m) and sub-subplot (3 x 5 m) were tillage, irrigation efficiency and fertilizer rate, respectively.

---

<sup>1</sup>Corresponding author: <sup>a</sup>Soil Science and Plant Nutrition Dept., Faculty of Agriculture, Erciyes University, Kayseri, Turkey.  
osmansonmez@erciyes.edu.tr

Tillage operations were done in the middle of April. Triple superphosphate (TSP) was applied to soil about 10 cm depth in late April prior to planting of cotton crop. Nitrogen was added as broadcast at the rate of 160 kg N ha<sup>-1</sup> for all plots. Cotton (variety of Stoneville-453 (*Gossypium hirsutum* L.)) was planted in 70 cm row with 15 cm intrarow spacing.

After planting two sprinkler irrigations were done to obtain uniform germination and to get a 20 cm plant height without any runoff. Before irrigation soil was sampled from 0-30, 30-60, and 60-90 cm depths. First of all, required irrigation water were calculated to bring up soil moisture content to field capacity, then more than 40 and 60% of field capacity were applied to plots to achieve 40 and 60% irrigation efficiencies. Irrigation was done when soil available water content decreased 50%. Cotton was irrigated (free irrigation) eight times during the growing period. After free irrigation, the runoff from both locations were collected from each plot of 3 by 5 m. Each plot was demarcated with metal frames inserted 10 cm depth of soil. Metal sheet was inserted on the downhill end of the plot to direct runoff to a collection container. Runoff volume was then recorded and sampled into glass jar kept at 5 °C until analyses.

Runoff was filtered for concentrations of sediment and SP and extracted for concentrations of bioavailable P (Bio P) and TP by the standard methods mentioned by [4]. Extracted aliquots were analyzed for P using the method of Murphy and Riley [5] by a Perkin Elmer Lambda 25 spectrophotometer. Sediment, RV, TP, Bio. P, and SP losses were summed over year.

Proc mixed was used with SAS for Windows version 9 (SAS, Cary, NC, USA). Mean separation was done using Least Significant Difference (LSD) at P ≤ 0.05 level of probability.

### 3. RESULTS and DISCUSSION

Significant interaction between tillage and irrigation efficiency for runoff volume in 2009 were found in both locations. Runoff volume was generally highest with low irrigation efficiency (40%) and Chisel-till (Table 1). Similar interaction was also found for sediment losses in 2009 at Koruklu location as well as in 2010 at Eyyubiye location. Generally the highest sediment losses were with Conventional-till and lower irrigation efficiency, whereas the lowest ones were with Chisel-till and higher irrigation efficiency (60%) (Table 2). Phosphorus losses significantly increased with increasing P rate and decreasing irrigation efficiency (Table 3). Phosphorus losses in 2010 for Eyyubiye location were ranged from 132.4 to 1298.6 g ha<sup>-1</sup> for total P (Table 3), 60.4 to 293.2 g ha<sup>-1</sup> for water soluble P (Table 4), 83.7 to 716.2 g ha<sup>-1</sup> for bioavailable P (Table 5).

Runoff volumes from agricultural lands were influenced by tillage systems [4]. Conventional tillage decreases RV compared to conservation tillage [6]. However, Seta et al. [7] reported opposite results. Some researchers also found that the effect of tillage was variable [4] due to differences in agronomic, climatic, and soil factors among studies. No-till decreased TP and algal-available P (AAP) [8]. Daverede et al. [9] studied effect tillage and soil P levels on runoff P and found that TP and AAP in runoff were not influenced by tillage practices but were closely related to Bray P1 soil extraction values and sediment concentrations in runoff. Smith et al. [10] found that no-tillage decreased TP loads but increased losses of soluble P (SP) because of stratification of P in no-till soil. Vertical tillage increased SP and TP loads compared to no-tillage [11].

The highest P losses were with low irrigation efficiency and conventional-till, whereas the lowest ones were with high irrigation efficiency and Chisel-till. Overall, the results suggested that increasing P rate increased P losses but no effects on sediment losses and runoff volume which were accelerated by conventional-till and low irrigation efficiency.

Table 1. Irrigation efficiency and tillage interaction for runoff volume

Tillage	Irrigation Efficiency	Eyyubiye		Koruklu	
		2009		2009	
		10 <sup>4</sup> L ha <sup>-1</sup>		10 <sup>4</sup> L ha <sup>-1</sup>	
CT	40	110,90	b*	128,90	b
	60	57,58	d	61,62	d
ChT	40	135,42	a	175,14	a
	60	68,66	c	84,91	c

\* Means with same letter within a column are not significantly different using least significant differences and p=0.05.

Table 2. Irrigation efficiency and tillage interaction for sediment loss in runoff

Tillage	Irrigation Efficiency	Eyyubiye		Koruklu	
		2010		2009	
		kg ha <sup>-1</sup>		kg ha <sup>-1</sup>	
CT	40	2941,5	a*	1668,1	a
	60	1434,1	c	546,5	c
ChT	40	2399,6	b	1121,2	b
	60	1378,8	c	414,8	c

\* Means with same letter within a column are not significantly different using least significant differences and p=0.05.

Table 3. Irrigation efficiency and phosphorus rate interaction for total P loss

IE	TSP (kg ha <sup>-1</sup> )	Eyyubiye		Koruklu	
		2010		2009	
		(g ha <sup>-1</sup> )		(g ha <sup>-1</sup> )	
40	0	235,2	c*	472,7	d
	90	1193,5	a	1245,1	b
	135	1298,6	a	1988,9	a
60	0	132,4	c	162,5	e
	90	721,7	b	611,7	cd
	135	789,6	b	858,7	c

\* Means with same letter within a column are not significantly different using least significant



differences and  $p=0.05$ .

*Table 4. Irrigation efficiency and phosphorus rate interaction for water soluble P loss in runoff*

IE	TSP (kg ha <sup>-1</sup> )	Eyyubiye	Koruklu
		2010 (g ha <sup>-1</sup> )	2010 (g ha <sup>-1</sup> )
	0	105,5 c*	53,7 c
40	90	428,7 a	178,4 a
	135	479,3 a	180 a
60	0	60,4 c	45,3 c
	90	249,2 b	123,5 b
	135	293,2 b	140,6 b

\* Means with same letter within a column are not significantly different

using least significant differences and  $p=0.05$ .

*Table 5. Irrigation efficiency and phosphorus rate interaction for bioavailable P Loss in Runoff*

IE	TSP (kg ha <sup>-1</sup> )	Eyyubi	Koruklu
		2010 (g ha <sup>-1</sup> )	2010 (g ha <sup>-1</sup> )
	0	155,7 c*	78,7 d
40	90	665,3 a	256,7 a
	135	716,2 a	261,2 a

	0	83,7 c	52,1 e
60	90	419,2 b	178,3 c
	135	477,9 b	208 b

\* Means with same letter within a column are not significantly different using least significant differences and  $p=0.05$ .

## 4. CONCLUSIONS

The highest P losses were with low irrigation efficiency and conventional-till, whereas the lowest ones were with high irrigation efficiency and Chisel-till. Overall, the results suggested that increasing P rate increased P losses but no effects on sediment losses and runoff volume which were accelerated by conventional-till and low irrigation efficiency.

## ACKNOWLEDGMENT

This research was supported by The Scientific and Technical Research Council of Turkey (TUBITAK-TOVAG-108O163).

## REFERENCES

- [1] A. R. Subba, R. K. Sammi, and P. N. Tahhar . "Phosphorus management- a key to boost productivity of soybean-wheat cropping system on swell-shrink soils," *Fert News.*, 1995, vol. 40, pp. 87-95.
- [2] J. T. Sims, and A.N. Sharpley. "Phosphorus—agriculture and the environment," ASA, CSSA, and SSSA, Madison, 2005.
- [3] A. E. Johnston, and J. K. Syers. "Changes in understanding the behaviour of soil and fertiliser
- [4] phosphorus: implications for their efficient use in agriculture," *Proc Int Fertil Soc* 589, 2006
- [5] York, UK, pp. 31.
- [6] R. J. Kimmell, G.M. Pierzynski, K.A. Janssen, and P.L. Barnes. (2001). "Effects of tillage
- [7] and P placement on P losses in grain sorgum/soybean rotation," *J Environ Qual.*, 2001, vol. 30, pp. 1324-1330.
- [8] J. Murphy, and J.P. Riley. "A modified single solution method for the determination of phosphate in natural waters," *Analytica Chimica Acta.* 1962, vol. 27, pp. 31-36.
- [9] J.D. Gaynor, and W.I. Findlay. Soil and phosphorus loss from conservation and conventional tillage in corn production," *J Environ Qual.*, 1995, vol. 24, pp. 734-741.
- [10] A.K. Seta, R.L. Blevins, W.W. Frye, and B.J. "Barfield. Reducing soil erosion and agricultural chemical
- [11] losses with conservational tillage," *J Environ Qual.*, 1993, vol. 22, pp. 661-665.
- [12] Sharpley AN, Smith SJ. "Wheat tillage and water quality in the Southern plains," *Soil Tillage Res.*, 1994, vol. 30, pp. 33-48.
- [13] I.C. Daverede, A.N. Kravchenko, R.G. Hoefl, E.D. Nafziger, D.G. Bullock, J.J. Warren, and L.C. Gonzini. "Phosphorus runoff: effect of tillage and soil phosphorus levels," *J Environ Qual.*, 2003, vol. 32, pp. 1436-1444.
- [14] Smith DR, Francesconi W, Livingston SJ, Huang C. "Phosphorus losses from monitored fields with conservation practices in the Lake Erie Basin, USA," *Ambio* 44 2015 (suppl. 2), S319-331.
- [15] Smith DR, Elizabeth A, Warnemuende-Pappas. "Vertical tillage impacts on water quality derived from rainfall simulations," *Soil Tillage Res.*, 2015, vol. 153, pp. 155-160.

# Evaluation of Drought Management in Turkey

*Belgin Cakmak<sup>1</sup>, Zeki Gokalp<sup>2</sup>, Sedat Karaman<sup>3</sup>*

---

## Abstract

Drought, rainfall for many years less than average to happen, it is a natural climatic event which can occur anywhere at any time. Drought has affected every aspect of our lives including environment, urban life, economy, technology, agriculture, food, clean water and sanitation. Drought is a natural phenomenon which has significant impacts such as economic, social and environmental. Because of the difficulty of determining the beginning and end of drought differs from other natural disasters. The effects of drought is often seen on agriculture as the first, and gradually spread to other water-dependent sectors. The importance of the drought is larger on the agricultural sector. Irrigation interval is prolonged and the amount of irrigation water is decreased with the occurrence of drought as a result of rainfall decreased. Accordingly, the yield is reduced, deteriorating product quality and production quantity is below expectation. The total rainfall in the root zone of crop during the growing period is more important than the total annual rainfall. Absence of requested water by crop during growing period is called agricultural drought. The studies which were performed before and after drought are defined as risk management and crisis management to reduce the effects of drought respectively. Therefore, plans should be developed for the purpose of drought fight and should be introduced risk management rather than crisis management. In our country, drought-related studies are managed by a crisis management approach. In this study; the causes, types and effects of drought were given and, drought management was discussed taking into account the institutional and legal status in Turkey.

**Keywords:** Drought, water resources, crisis management, Turkey

---

## 1. INTRODUCTION

Natural disasters play significant roles in human life. Drought is a natural disaster and commonly depends on climate and regional characteristics, soil structure, population increase, environmental and several other factors. Since it has long-term impacts, it should be forecasted ahead [1]. Drought is somehow different from the other natural disasters since it is hard to estimate the beginning and end of the phenomenon. It increases the severity slowly and impacts may last years after the end to the phenomenon.

Droughts can be seen in all climate zones, but the sensitivity of the sites to drought and impact levels may vary from one region to another. Definition of drought may change with the region of impact. For instance, 6 days or more non-precipitated period can be called drought for Bali, less than 180 mm annual precipitation may be a drought for Libya, daily total precipitation of less than 0.25 mm in consecutive 15 days can be called as a drought for the United Kingdom [2]. In Turkey, such a definition is hard to make, but the regions with an annual total precipitation of 400 mm or less is accepted as dry regions [3].

Turkey is located in semi-arid climate zone and spatial and temporal distribution of precipitations is irregular in Turkey. Currently available water resources are not able to meet the demands of ever-increasing population and ever-developing industry. Quite excessive amounts of water used in surface irrigations. Domestic, agricultural and industrial water quality is also decreasing with increasing industrial and environmental pollutions. Together with all these negative issues, current climate change and global warming aggravates the severity of droughts in Turkey [3].

Just because of geographical position and patterns, Turkey has several climate zones and microclimate sections. Climate parameters, especially the precipitations with the greatest impacts on agricultural production, exhibit great spatial and temporal variations. Annual average precipitation of Turkey is 643 mm, but several regions experience water deficits and droughts just because of these irregular distributions.

Mitigation of negative impacts of drought is totally depends on measures taken ahead of the droughts and proper planning for the period of droughts. Therefore, the measures to be taken ahead of droughts and the steps to be taken throughout the droughts should separately be planned and implemented [4]. Drought management strategies (crisis management, risk management) constitute the bases of such planning activities. A reactive approach is adapted in Turkey in drought management strategies. A proactive risk management including the measures to be taken ahead of droughts is more successful than crisis management implemented to mitigate the negative impacts of droughts. Therefore, plans should be developed in Turkey to fight against the droughts and risk management should be adapted instead of crisis management.

---

<sup>1</sup> Ankara University, Agricultural Faculty, Department of Agricultural Structures and Irrigation, 06360, Dışkapı/Ankara, Turkey. [Belgin.Cakmak@agri.ankar.edu.tr](mailto:Belgin.Cakmak@agri.ankar.edu.tr)

<sup>2</sup> Erciyes University, Agricultural Faculty, Department of Biosystems Engineering, 38039, Melikgazi/Kayseri, Turkey. [zekigokalp@yahoo.com](mailto:zekigokalp@yahoo.com)

<sup>3</sup> Corresponding author: Gaziosmanpaşa University, Agricultural Faculty, Department of Biosystems Engineering, 38039, Tasliciftlik/Tokat, Turkey. [skaraman@gop.edu.tr](mailto:skaraman@gop.edu.tr)

Previous studies carried out in Europe indicate significant variations in temperature, precipitation and flows. About 3.0-3.5 °C increase in temperature and 15-30% decrease in precipitations were forecasted for Southern Europe and Mediterranean climate zone including Turkey [5]. It was indicated at different emission scenarios for Gediz and Büyük Menderes basins that temperatures will increase by 1.2 °C, 2 °C and 4.4 °C and precipitations will decrease by 5.8, 10.2% and 23.8% respectively in the years 2030, 2050 and 2100 [6]. In another study, [7] investigated the impacts of climate change on water resources in Büyük Menderes basin for the past 45 years and reported 1 °C increase in temperature during that period.

The changes in precipitation and temperature values may result in significant decreases in available water resources of the regions and may exert a water deficit or water stress on water-dependent industries. Therefore, Turkey urgently should focus on works to be done to be ready for droughts.

In present study, initially brief information was provided about the reasons and impacts of droughts and then the practices for drought management in Turkey were presented and discussed.

## 2. REASONS, TYPES AND IMPACTS OF DROUGHT

### 2.1 Reasons of drought

#### 2.1.1 Natural reasons

Turkey is a high-altitude country and average altitude is higher than 1100 m. Such a case greatly influences climate conditions of the regions. In countries like Turkey in mid-zone, there are two different periods as of precipitated winters and dry summers. Turkey gets about 35% of total precipitation in winter months [4].

#### 2.1.2 Anthropogenic reasons

Drought vitally influences water resources, human life, agriculture, food, economy, environment and health. It is quite hard to estimate the duration and time of drought. Beside natural factors, anthropogenic factors also significant affect the course of drought and may aggravate the severity of drought. Human activities on water policies, water supply and demand and the activities influencing climate change are the anthropogenic reasons of droughts [8].

#### 2.1.3 Climate change

Climate system is a complex system including atmosphere, land surfaces, snow and ice, oceans and other water bodies and living organisms. Turkey has a semi-arid climate and the greatest reason of severe droughts is the change in places with water demands and precipitations. Global climate change-induced droughts may result in sudden floods and sea level rises. Increased droughts together with decreasing precipitations and increased temperatures may then result in increased pests, water deficits and hungers and forest fires. Therefore, climate change should be emphasized today as much as health and hunger [3].

## 2.2. Types of drought

There are four types of drought as of meteorological, agricultural, hydrologic and socio-economic droughts [2]. Drought starts as meteorological drought, goes on as agricultural and hydrologic drought and ends up as socio-economic drought (Figure 1). Meteorological drought is defined usually on the basis of the degree of dryness (in comparison to some “normal” or average amount) and the duration of the dry period. Definitions of meteorological drought must be considered as region specific since the atmospheric conditions that result in deficiencies of precipitation are highly variable from region to region. Dry periods are defined as the number of days with less than threshold values.

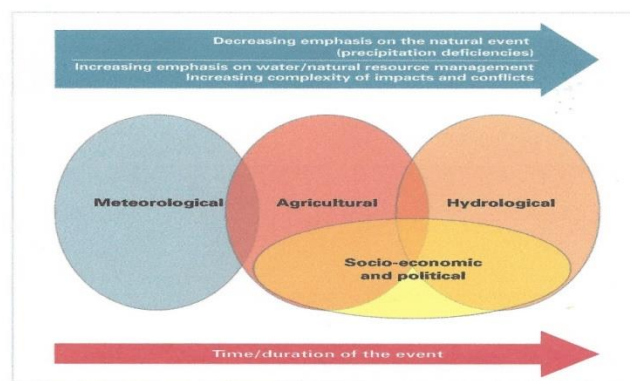

Figure 1. Types of droughts

Agricultural drought links various characteristics of meteorological (or hydrological) drought to agricultural impacts, focusing on precipitation shortages, differences between actual and potential evapotranspiration, soil water deficits, reduced groundwater or reservoir levels, and so forth. Plant water demand depends on prevailing weather conditions, biological characteristics of the specific plant, its stage of growth, and the physical and biological properties of the soil. A good definition of agricultural drought should be able to account for the variable susceptibility of crops during different stages of crop development, from emergence to maturity. Deficient topsoil moisture at planting may hinder germination, leading to low plant populations per hectare and a reduction of final yield. However, if topsoil moisture is sufficient for early growth requirements,

deficiencies in subsoil moisture at this early stage may not affect final yield if subsoil moisture is replenished as the growing season progresses or if rainfall meets plant water needs.

Hydrological drought is associated with the effects of periods of precipitation (including snowfall) shortfalls on surface or subsurface water supply (i.e., streamflow, reservoir and lake levels, groundwater). The frequency and severity of hydrological drought is often defined on a watershed or river basin scale. Although all droughts originate with a deficiency of precipitation, hydrologists are more concerned with how this deficiency plays out through the hydrologic system. Hydrological droughts are usually out of phase with or lag the occurrence of meteorological and agricultural droughts. It takes longer for precipitation deficiencies to show up in components of the hydrological system such as soil moisture, streamflow, and groundwater and reservoir levels. As a result, these impacts are out of phase with impacts in other economic sectors. For example, a precipitation deficiency may result in a rapid depletion of soil moisture that is almost immediately discernible to agriculturalists, but the impact of this deficiency on reservoir levels may not affect hydroelectric power production or recreational uses for many months. Also, water in hydrologic storage systems (e.g., reservoirs, rivers) is often used for multiple and competing purposes (e.g., flood control, irrigation, recreation, navigation, hydropower, wildlife habitat), further complicating the sequence and quantification of impacts. Competition for water in these storage systems escalates during drought and conflicts between water users increase significantly.

Socioeconomic definitions of drought associate the supply and demand of some economic good with elements of meteorological, hydrological, and agricultural drought. It differs from the aforementioned types of drought because its occurrence depends on the time and space processes of supply and demand to identify or classify droughts. The supply of many economic goods, such as water, forage, food grains, fish, and hydroelectric power, depends on weather. Because of the natural variability of climate, water supply is ample in some years but unable to meet human and environmental needs in other years. Socioeconomic drought occurs when the demand for an economic good exceeds supply as a result of a weather-related shortfall in water supply [8].

### **2.3. Impacts of drought**

Drought produces a complex web of impacts that spans many sectors of the economy and reaches well beyond the area experiencing physical drought. This complexity exists because water is integral to society's ability to produce goods and provide services.

Impacts are commonly referred to as direct and indirect. Direct impacts include reduced crop, rangeland, and forest productivity, increased fire hazard, reduced water levels, increased livestock and wildlife mortality rates, and damage to wildlife and fish habitat. The consequences of these direct impacts illustrate indirect impacts. For example, a reduction in crop, rangeland, and forest productivity may result in reduced income for farmers and agribusiness, increased prices for food and timber, unemployment, reduced tax revenues because of reduced expenditures, foreclosures on bank loans to farmers and businesses, migration, and disaster relief programs [9].

#### **2.3.1. Economic Impacts**

Many economic impacts occur in agriculture and related sectors, because of the reliance of these sectors on surface and groundwater supplies. In addition to losses in yields in both crop and livestock production, drought is associated with insect infestations, plant disease, and wind erosion. The incidence of forest and range fires increases substantially during extended periods of droughts, which in turn places both human and wildlife populations at higher levels of risk.

Income loss is another indicator used in assessing the impacts of drought. Reduced income for farmers has a ripple effect. Retailers and others who provide goods and services to farmers face reduced business. This leads to unemployment, increased credit risk for financial institutions, capital shortfalls, and eventual loss of tax revenue for local, state, and federal governments. Prices for food, energy, and other products increase as supplies are reduced. In some cases, local shortages of certain goods result in importing these goods from outside the drought-stricken region. Reduced water supply impairs the navigability of rivers and results in increased transportation costs because products must be transported by alternative means. Hydropower production may also be significantly affected [10].

#### **2.3.2. Environmental Impacts**

Environmental losses are the result of damages to plant and animal species, wildlife habitat, and air and water quality, forest and range fires, degradation of landscape quality, loss of biodiversity, and soil erosion. Some of these effects are short-term, conditions returning to normal following the end of the drought. Other environmental effects last for some time and may even become permanent. Wildlife habitat, for example, may be degraded through the loss of wetlands, lakes, and vegetation. However, many species eventually recover from this temporary aberration. The degradation of landscape quality, including increased soil erosion, may lead to a more permanent loss of biological productivity.

#### **2.3.3. Social Impacts**

Social impacts involve public safety, health, conflicts between water users, reduced quality of life, and inequities in the distribution of impacts and disaster relief. Many of the impacts identified as economic and environmental have social components as well. Population migration is a significant problem in many countries, often stimulated by a greater supply of food and water elsewhere. Migration is usually to urban areas within the stressed area, or to regions outside the drought area. Migration may even be to adjacent countries. When the drought has abated, the migrants seldom return home, depriving rural areas of valuable human resources. The drought migrants place increasing pressure on the social infrastructure of the urban areas, leading to increased poverty and social unrest.

### 3. DROUGHT MANAGEMENT IN TURKEY

There are several organizations and institutions responsible for drought management in Turkey. These are as follows: Ministry of Forestry and Water Affairs, General Directorate of Meteorology, State Hydraulic Works, General Directorate of Water Management, Ministry of Food Agriculture and Livestock, General Directorate of Agricultural Reforms, General Directorate of Combating Desertification and Erosion and Desertification, General Directorate of Agricultural Researches and Policies.

There are two basic approaches used in drought control. The first one is crisis management (reactive) including the activities to be carried out following the emergence of drought and the other one is risk management (proactive) including the activities to be carried out ahead of the emergence of drought [11]. It is impossible to mitigate the impacts of drought only with crisis management. The critical point is the risk management for the period before drought. In risk management, the pre and post-drought conditions are taken into consideration and then preparation, impact mitigation, early warning and estimations are made. Long-term drought policies are prepared, drought monitoring centers and networks are established and measures are taken for efficient and rational water use. Drought management plan is prepared to mitigate the negative impacts of droughts and to keep water deficits at minimum level. The primary objective is to solve drought possible as soon as possible. Such a plan reduces the damages, develops cooperation among organizations and institutions and supports all sharers through early warning and monitoring system [3].

In Turkey, "Agricultural Drought Action Plan" is prepared by The Ministry of Food Agriculture and Livestock, the Ministry of Forestry and Water Affairs, the Ministry of Energy and Natural Resources and the Ministry of Interiors. A coordination council was established for agricultural droughts in February 2007 by the cooperative works of these organizations. The council prepared an action plan. The plan includes the measures to be taken to mitigate the negative impacts of potential droughts, to raise awareness in public, water users, farmers and non-governmental organizations and propose solutions for droughts. Under coordination council, there is an early warning and forecasting committee and a risk assessment committee. Agricultural drought crisis centers were established in provinces under the authority of mayors and agricultural drought action plans are being prepared for each province (Figure 2).

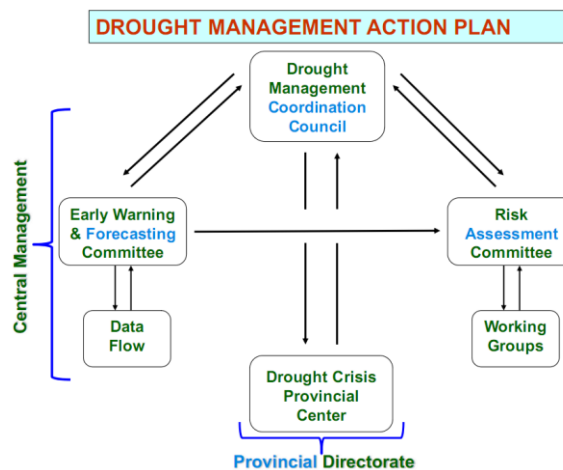

Figure 2. Drought management in Turkey

In drought management, optimum irrigation programs should be developed for more efficient water use in agriculture. Non-programmed and uncontrolled irrigation practices result in serious water losses in agriculture. Irrigation associations and cooperatives should implement a planned water distribution. Irrigation organizations should calculate irrigation water requirements by using meteorological data. Irrigation efficiencies should be improved and high-efficiency irrigation methods should be widespread [12]. Low-efficiency surface irrigation methods should be abandoned as soon as possible [13] and pressurized closed pipe systems should be used in irrigations.

Under drought conditions, marginal waters (wastewater, drainage water, saline water, even sea water) may be used in agriculture provided that relevant water treatment measures were taken. Re-use of treated waters may provide a significant source and allow the allocation of fresh water resources to other sectors [14]. Drainage waters can be used either as mixed with fresh water or in alternated fashion [15].

### 4. CONCLUSION AND RECOMMENDATIONS

The spatial and temporal variations and changes in quantity of precipitations indicate a potential risk for drought in Turkey. Turkey experienced several serious droughts and some of them were quite devastating (1928-1929, 2007-2008 etc). Since

agriculture is the greatest water user industry, it is the first sector to influence by a potential drought. Although there are several water storage structures like dams and embankments for water supply and delivery, water deficits are experienced in cases with deficit precipitations. Therefore, water saving and efficient water use should be encouraged to mitigate the negative impacts of droughts. Prevention of water losses, implementation of pressurized irrigation systems, use of closed pipe systems for water delivery and distribution, implementation of optimum irrigation programs, raising awareness on deficit irrigations, re-use of treated wastewaters, use of water harvesting technologies, volume-based water pricing are among the measures to be taken to prevent potential impacts of droughts. Beside an efficient water management, drought management strategies should be established accordingly to prevent or mitigate the impacts of droughts. Drought management strategies are composed of risk management and crisis management implementations. Risk management is the most critical stage of in combating with droughts. Legal issues should be carried out for an efficient drought management and watershed-based drought plants should be prepared, works should be developed for drought monitoring and regular reports should be presented accordingly. "Drought management plans" should be integrated into "Watershed Protection Plans".

## REFERENCES

- [1] G.Ü. Bacanlı, B. Saf, Kuraklık Belirleme Yöntemlerinin Antalya İli Örneğinde İncelenmesi, Pamukkale Üniversitesi Mühendislik Fakültesi İnşaat Mühendisliği Bölümü, Denizli, 2012.
- [2] Anonymous, Understanding and defining drought, National Drought Mitigation Center, <http://drought.unl.edu/whatis/concept.htm>, 2006.
- [3] M. Kadioğlu, Kuraklık Kırını Risk Yönetimi; Kadioğlu, "Afet Zararlarını Azaltmanın Temel İlkeleri"; s. 277-300, JICA Türkiye Ofisi Yayınları No: 2, Ankara, (b), 2008.
- [4] E. Kapluhan, Türkiye'de kuraklık ve kuraklığın tarıma etkisi. Marmara Coğrafya Dergisi sayı: 27, ocak - 2013, s. 487-510, İstanbul, 2013.
- [5] Y. Sarcan, Avrupa Birliği ve Türkiye'de Kuraklık Yönetimi Uygulamalarının Değerlendirilmesi. Orman ve Su İşleri Bakanlığı Su Yönetimi Genel Müdürlüğü. Orman ve Su İşleri Uzmanlık Tezi. 147s. Ankara, 2015.
- [6] S. Özkul, O. Fıstıkoğlu, N. Harmancıoğlu, İklim değişikliğinin su kaynaklarına etkisinin Büyük Menderes ve Gediz havzaları örneğinde değerlendirilmesi, TMMOB 2. Su Politikaları Kongresi (2):309-321, Ankara, 2008.
- [7] Ö.F. Durdu, Effects of climate change on water resources of the Büyük Menderes river basin, western Turkey, Turk. J. Agric. For (34):319-332, 2010.
- [8] MED WS&D WG, Mediterranean Water Scarcity & Drought Working Group (MED WS&D WG), Mediterranean Water Scarcity and Drought Report, Technical Report - 009 - April, 2007.
- [9] D. Schramm, R. Dries, Natural Hazards: Causes and Effects, Study Guide for Disaster Management, Disaster Management Center University of Wisconsin-Madison, 1993.
- [10] D.A. Wilhite, M.D. Svoboda, M.J. Hayes, Understanding the complex impacts of drought: A key to enhancing drought mitigation and preparedness, Water Resource Management, 21:763-774, 2007.
- [11] S. Anaç, İklim değişimi ve kuraklık yönetiminde inovatif yaklaşımlar, 2007- 2011 A New Era and New Horizons, İstanbul Forum Enst. İstanbul, 2008.
- [12] S. Önder, R. Kanber, D. Önder, B. Kapur, Global iklim değişikliklerine bağlı olarak sulama yöntem ve işletim tekniklerinde gelecekte ortaya çıkabilecek değişiklikler, GAP IV. Tarım Kongresi 21-23 Eylül 2005, Şanlıurfa, 2005.
- [13] T. Aküzüm, M. F. Selenay, B. Çakmak, Sulama yönetimi ve sürdürülebilir su kullanımı, I. Ulusal Sulama ve Tarımsal Yapılar Sempozyumu, 27-29 Mayıs, Kahramanmaraş, 2010.
- [14] J.D. Oster, R. Grathan, Drainage water reuse, Irrigation Drain. Syst 16:297-310, 2002.
- [15] L. Tingu, X. Juan, L. Guangyong, M. Jiah Hua, W. Jianping, L. Zhinzhong, Z. Jianguo, Effect of drip irrigation with saline water on water use efficiency and quality of watermelons, Water Resource Management 17:395-408, 2003.

# The Role and the Impact of Digital Certificate and Digital Signature in Improving Security During Data Transmission

*Nexhibe Sejfuli Ramadani<sup>1</sup>, Verda Misimi<sup>2</sup>, Erenis Ramadani<sup>3</sup>, Florim Idrizi<sup>4</sup>*

---

## Abstract

*This paper is cryptographic oriented research, aiming to describe the notion, role and impact of digital signature and digital certificate for the wide audience. Security improvement during data transmission comes as a result of the huge growth of electronic communications. While one party is trying to secure these data, there is always another party trying to reach and use them in several cases, so understanding the importance of digital security is quite important for everyone using a computer nowadays. Thus, the research explains the need for these types of technologies. Reading the paper, you will meet a comparison between paper and digital signature and digital certificate compared to digital signature. During this research were used Observational and Correlational research methodologies. As a conclusion, we can say that electronic signatures and certificates are making life easier for organization leaders, HR and all of other company sectors in a variety of industries, allowing them to freely announce, communicate or exchange several documents or high sensitive data.*

**Keywords:** *cryptography, digital certificate, digital signature, private key, public key*

---

## 1. INTRODUCTION

Digital signature notion was first used and described in late 1976 by Whitfield Diffie and Martin Hellman, although it was still just an assumption. Soon after that, RSA algorithm was invented by Ronald Rivest, Adi Shamir and Leonard Adleman, which, in that time, produced only primitive digital signature. Only in 1989, the first widely marketed software package using RSA algorithm was released. It was called *Lotus Notes 1.0*.

Later on, there were more digital signature schemes developed, such as *Lamport signatures*, *Merkle signatures* – also known as *Merkle trees* or *Hash trees*, and *Rabin signatures*.

In the other hand, *digital certificate* is an electronic document which is used to prove ownership of a *public key*<sup>5</sup>. It contains information about the key itself, information about owner, and the digital signature that verifies correctness of certificate's content. In other words, the digital certificate is an electronic passport that allows information exchange securely over the Internet using the *public key infrastructure* (PKI).

Digital certificates are handled by a trusted *certificate authority* (CA)<sup>6</sup>. Thus, to provide validity of the certificate, it is digitally signed by a root certificate that belongs to these CA. Operating systems and browsers maintain lists of trusted CA root certificates so they can verify that the certificate is issued and signed. [1]

## 2. DIGITAL SIGNATURE

Digital signature is a mathematical technique for validating the authenticity and integrity of several electronic components, such as messages, software or digital documents.

It is intended to ensure that there will be no tampering or impersonation while communicating in electronic way.

### How it works?

Digital signature technology is based on public key cryptography, also known as *asymmetric cryptography*. The most used algorithm in this type of cryptography is RSA, where one can generate two linked keys: *private key* and *public key*. First, there

---

<sup>1</sup>Corresponding author: Tetova State University, Faculty of Mathematics - Natural Sciences, Department of Informatics, 1200, Tetovo, Macedonia. [nexhibe.sejfuli@gmail.com](mailto:nexhibe.sejfuli@gmail.com)

<sup>2</sup>Tetova State University, Faculty of Mathematics - Natural Sciences, Department of Informatics, 1200, Tetovo, Macedonia. [verda.misimi@hotmail.com](mailto:verda.misimi@hotmail.com)

<sup>3</sup>Software Developer at AdaptiveScale, 1200, Tetovo, Macedonia. [erenisramadani@gmail.com](mailto:erenisramadani@gmail.com)

<sup>4</sup>Tetova State University, Faculty of Mathematics - Natural Sciences, Department of Informatics, 1200, Tetovo, Macedonia. [florim.idrizi@unite.edu.mk](mailto:florim.idrizi@unite.edu.mk)

<sup>5</sup>Generated key by the owner of the certificate, in order to encrypt the message or data

<sup>6</sup>Certificate Authority – entity that issues digital certificates.



is created a one – way hash of the electronic data that is required to be signed. The private key is used to encrypt this hash. Thus, encrypted hash – along with the rest of the information represent the digital signature.

- *But, why encrypting the hash instead of the entire message or document?*

Because, encrypting the entire document costs a lot of time. The hash function can convert an input into a fixed length value, which, compared to the document length, is much shorter.

The value of the hash is unique. It means that for a given amount of data, there is one and only one unique hash value. Changing a single character or a single bit of that data means a completely different hash value. Thus, using the signer's public key, the other party can decrypt the hash, and validate the integrity of the data. So, if the decrypted hash is computed again, and it matches with the first one, it means that the data has not changed after signing. In the other hand, if the decrypted hash does not match, it means that there has either been tampering in the data, or the signature was created with a private key generated separately from the public key used to decrypt these data.

But, all of this said above, does not mean that the message or the document has to be encrypted. Instead, the digital signature works with both, encrypted and decrypted messages or documents. It is meant to ensure that the sender of these messages or documents is the one expected to send.

Modern data – transmitting software, such as mail applications support the use of digital signature and certificate.

### **Application**

The most common application of digital signature is authenticating the source of the message, ensuring message integrity and ensuring that the sender will not deny authenticity.

### **Authentication**

Although digital messages contain information about the sender, these information may offer be incorrect or not accurate. In this case, digital signature allows to make sure that the sender of a message, is the one we think it is. If a user is the owner of a digital signature secret key, a valid signature ensures that the message is sent by that user. The most sensitive is the financial section, where the importance of high confidence in sender authenticity is obvious. For example, if a branch of some bank requests from the central office to make changes in the balance of an account, acting on such a request, not being sure that the request comes from a known and authorized source could be a fatal mistake.

### **Integrity**

During data transmission, there is always potential risk that the transmitted data can be altered in the meanwhile. Even if the message is encrypted, it can be altered without knowing its meaning or what is being changed. There are just a few algorithms that can prevent this scenario, but the most of them can not. However, if the message is digitally signed, every minor possible change of that message is detected. Additionally, because of the hash function, there is no way to produce a new message with a valid signature, after it has been signed.

### **Non repudiation**

Non – repudiation is also an important reason to use digital signature. This property aims to make sure that, the entity that once has signed some information, can't deny it at a later time. Furthermore, having access to the public key only, does not allow someone to create a fake valid signature.[7]

## **3.DIGITAL CERTIFICATE**

Digital certificate is some kind of certificate issued by trusted Certificate Authorities (CA) aiming to verify the identity of the certificate holder. Typically, a digital certificate contains the following information: unique *serial number* used to identify the certificate, identified *entity* or *individual* by the certificate, *the algorithm* used to create the signature, the *CA* that verifies the information in the certificate, period of time including *starting date* and *expiry date* of validity of the certificate, *public key* and *the thumbprint* (to make sure that the certificate is not modified "itself").

### **Application**

Digital certificates are very important component of *Transport Layer Security* (TLS), also known as *SSL* (*Secure Socket Layer*), preventing cyber attackers from impersonating a website or server. Additionally, they are used in email encryption or code signing.

### **Website security using Digital Certificate**

Web browsers validate that a TLS web server is authentic, so the users can feel secure in their interaction with the website, ensuring it does not have any third party listener and it is who it claims to be.

To get the certificate, a website operator must apply to a certificate provider with a *certificate signing request*. This request is an electronic document containing website name, contact email address, company information and the public key. The private key is not required for security issues. The certificate provider signs the request, producing a public certificate.

Before issuing the certificate, the provider requests the contact email address from a public *domain name registrar*, and ensures that published address matches with email address provided by the applicant.

So, when a user connects to a website who uses a link such as <https://www.example.com>, if the browser does not give any certificate warning message, then the user is good to go.

### Public key

Public key is very familiar notion in cryptography. It is a public value that is used for two main purposes: *authenticating* messages or other data originated with a holder of the paired private key; *encrypting* a message to ensure that only the holder of the corresponding private key can decrypt it.

### Public Key Infrastructure (PKI)

A public key infrastructure supports the distribution and identification of public key encryption, enabling users to securely exchange data over network and verify the identity of the other party.

In other words, PKI is an arrangement that binds public keys with respective identities of entities. The binding is established through a process of registration and issuance of certificates at and by a CA. During registration process, *registration authority* (RA) makes sure that the registration is valid and correct. RA is responsible for accepting requests for digital certificates and authenticating the entity making the request.

A typical PKI consists of hardware, software, policies and standards to manage the creation, administration, distribution and revocation of keys and digital certificates.

### Public Key Cryptography

Also known as *Asymmetric Cryptography*, it is a cryptographic technique that uses private and public keys to encrypt and decrypt data. The keys are not identical large value data, usually, 128 or 256-bit strings generated by random generator methods. They are mathematically linked between them.

The public key is meant to be shared, while the private key must be kept secure.

Using this technique, everyone can encrypt a message or data using the public key of the receiver, but that encrypted message or data can only be decrypted with the private key.

Unlike *symmetric key algorithms*, public key algorithms does not require a secure channel to exchange keys between communicating parties.

Authentication of messages is done by hashing messages to produce a unique value of the message, which is encrypted using the private key and produces a digital signature.

There are several manners to verify the signature, as mentioned in the sections above.

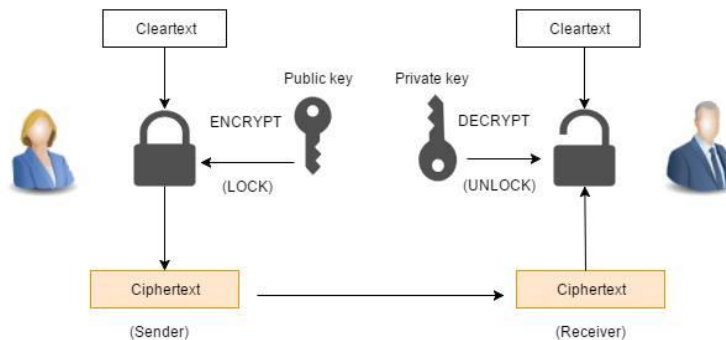

Figure 20: Encryption/Decryption process using Public/Private Key

## 4.COMPARISON

In this section, readers will have the chance to read and see comparison between traditional and digital signatures, and also the comparison between digital signature and digital certificate.

### Comparison between Digital and Traditional Signature

A person's signature is a very personal thing. Unique to handwriting, it may be the full name, a portion of the name or just the initials, but it can also include various loops and flourishes.

Like digital signature, the traditional one is developed as a way to create a unique identifier for each community member. For the most part, they are associated with written documents, although they may be added to just about anything. When they are added to paper, their main purpose is to signify some kind of approval or consent to what has been captured on that document.

However, adding signature to documents is not the perfect signature solution, because they can be very easily forged or copied. For example, Joseph Cosey was a famous forger that mastered the signatures of many famous figures, including Ben Franklin. Today, his forgeries are as famous as originals he doubled.

Below this paragraph is represented a table of comparison between digital and traditional (paper) signature.

Table 6: Comparison table of signatures

Property	Traditional	Digital
Can be applied to electronic documents and transactions	No	Yes
Signature verification can be automated	No	Yes
Signature automatically detects alterations to the document	No	Yes
Can be used to signify a commitment to a contract or document	Yes	Yes
Can be augmented by use of a witness to the signature process	Yes	Yes
Recognized by legislation	Yes	Yes

### Comparison between Digital Certificate and Digital Signature

Digital signature is a mechanism that is used to verify that a particular digital document or message is authentic, whereas digital certificates are used mainly in websites to increase their trustworthiness to its users. When digital certificates are used, the assurance is mainly dependent on the assurance provided by the CA. With digital signatures, the receiver of the message can verify that the information is from a trusted sender or is not modified.

### 5.RESULTS

Although digital certificates are widely used by large corporations, the practices may not be totally secure. Even though these certificates guarantee equity for the user of a website, the relation between the certificate owner, website operator and website owner might be ambiguous and thus, not guaranteed. Researches and studies have proven that authentication and authorization should be separated, although digital certificates adapt information with authorization inside their scope.

A digital signature is a mathematical scheme for demonstrating the authenticity of a digital message or document. A valid digital signature gives a recipient reason to believe that the message was created by a known sender, and that it was not altered in transit.

In some countries, including the United States, India, and members of the European Union, electronic signatures have legal significance. However, laws concerning electronic signatures do not always make clear whether they are digital cryptographic signatures in the sense used here, leaving the legal definition, and so their importance, somewhat confused.

Digital signature scheme is secure because these schemes are based in encryption supported in a secure way by concrete algorithms. The most common algorithm for digital signature should provide assurance that the signature guarantees non – repudiation, non – recidivist and the message can't be changed. For furthermore, the signature should be able to resist all possible attacks.

### 6.CONCLUSION

After the effort put on this paper, we can freely say that security in electronic communicating is improving in a good rate, but there are a lot of things that require much more work and attention.

Cryptography may be a trending technology, but since security is an issue that lacks from humans, it is only as good as the practices of the people who are in touch with it. Normal users write keys everywhere, choose easy-to-remember ones or don't even change them for life. The complexity of cryptography effectively puts it outside of most people, and thus, motivation for the practices of cryptographic security is missing.

### ACKNOWLEDGMENT

We are pleased to acknowledge all the friends and colleagues for their endless support, our families also, and everyone contributed on finishing this research.

We are also very thankful to ICSD Organization Committee for making this conference possible.

Thank you!

### BIBLIOGRAPHY

- [1] Delfs, Hans; Knebl, Helmut. *Introduction to Cryptography: Principles and Applications, Third Edition*. ISBN 978-3-662-47974-2. Berlin, Germany: Springer, 2015.
- [2] Talbot, John; Welsh, Dominic. *Complexity and Cryptography: An Introduction*. Cambridge University Press, 2006.
- [3] Oppliger, Rolf. *Contemporary Cryptography*. ISBN 1-58053-642-5. 685 Canton Street, Norwood, MA, 02062, 2005.

- [4] Menezes, Alfred J.; van Oorschot, Paul C.; Vanstone, Scott A. *Handbook of Applied Cryptography*.
- [5] Goldreich, Oded. *Foundations of Cryptography – A Primer*. ISBN 1-933019-02-6. PO Box 1024, Hanover, MA, 02339, USA
- [6] Stallings, William. *Cryptography and Network Security: Principles and Practices, Fourth Edition*. 0-13-187319-9. Prentice Hall, November 16, 2005.
- [7] Idrizi, Florim. *Kriptografia e kombinuar si mjet për sigurinë e transaksioneve elektronike në Republikën e Maqedonisë*. PhD Thesis, University of Tirana, Faculty of Natural Sciences, Department of Informatics, 2013.

# *Bacillus thuringiensis* parasporins and their use in controlling cancer cells

Semih Yilmaz<sup>1</sup>, Aysun Cetin<sup>2</sup>, Rıdvan Temizgul<sup>3</sup>

## Abstract

Parasporins are Cry proteins produced by *Bacillus thuringiensis* (Bt) strains during sporulation processes and notable for targeting the cancer cells with their unique cytotoxicity mechanism without exerting haemolytic effect on normal cells. Parasporins are specifically produced by Bt strains with non-insecticidal effect. Although the studies on parasporins go back to the 1970s, comprehensive scan about the cytotoxicity of parasporins was performed by Mizuki and colleagues. Considering that these proteins exhibit selective toxicities on human cancer cell lines but not on normal cells, detailed studies about the mode of action of anticancer effect was investigated in several countries. Specificity and abundance of parasporin producing Bt species in nature brought them into an important position in terms of developing anticancer agents. Parasporins are classified into six groups by the committee of parasporin classification and nomenclature as parasporin-1 (PS1), PS2, PS3, PS4, PS5, and PS6 by taking the amino acid homology into account. Activated parasporins display cytotoxicity at varying degrees in different cancer cell lines. There are numerous studies about promoting the use of Bt parasporins as anticancer agent in human, but in depth studies should be carried out about their usability in model organisms. Researches should also be deepened especially in vivo due to production of different types of parasporins with different mechanism of action by different Bt strains. Clarification of the molecular mechanisms of toxicity for every candidate parasporin on cancer cell lines may ease the development of anticancer agents. Thus, the present study was conducted to provide a review about the cytotoxic impacts of Bt parasporin on human cancer cell lines.

**Keywords:** *Bacillus thuringiensis*, parasporin, cancer cells

## 1. INTRODUCTION

### 1.1. *Bacillus thuringiensis* and an overview of its toxin proteins

*Bacillus thuringiensis* (Bt) is an aerobic, Gram (+) and spore forming entomopathogenic bacterium belonging to *Bacillus cereus* group together with *Bacillus anthracis* [1], [2]. It was first discovered in diseased larvae of the silkworm, *Bombyx mori* by Ishiwata and characterized by its well-known insecticidal  $\delta$ -endotoxin proteins [3]. It has a simple life cycle and under appropriate environmental conditions and nutrient supply their spores germinate and go into vegetative form. But, if one or more of compounds as carbohydrates, oxygen, amino acid or others are insufficient in their nutrient; they form parasporal bodies together with spore and delta endotoxins (Figure 1).

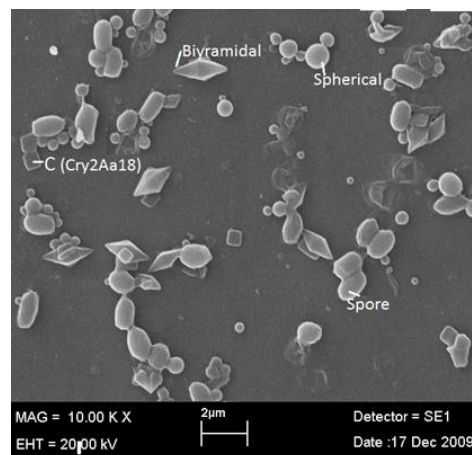

<sup>1</sup>Corresponding author: Erciyes University, Faculty of Agriculture, Department of Agricultural Biotechnology, 38039, Melikgazi/Kayseri, Turkey. [yilmazsemh@yahoo.com](mailto:yilmazsemh@yahoo.com)

<sup>2</sup>Erciyes University, Medical Faculty, Department of Medical Biochemistry, 38039, Melikgazi/Kayseri, Turkey. [aysuncetin@yahoo.com](mailto:aysuncetin@yahoo.com)

<sup>3</sup>Erciyes University, Faculty of Science, Department of Biology, 38039, Melikgazi/Kayseri, Turkey. [rtemizgul@erciyes.edu.tr](mailto:rtemizgul@erciyes.edu.tr)

Figure 1. SEM view of *Bt* SY49.1 spore crystal mixture [4]

*Bt* can produce various types of parasporal inclusion bodies known as Cry (crystal delta-endotoxins) and Cyt (cytolysins) proteins during sporulation phase. Cry proteins are widely used worldwide as insecticidal biopesticides in agricultural fields. But, it was also reported that the number of non-insecticidal strains of *B. thuringiensis* in natural environments are more widely distributed than insecticidal strains [5], [6]. Mizuki et al., [7] observed the first group of functional Cry proteins, known as parasporins, in non-insecticidal *Bt* stains. Parasporins are grouped into six family as PS1-PS6 by the parasporin nomenclature committee [8]. They specified as non-haemolytic and preferentially kill cancer cells [9]. *Bt* 89-T-34-22 isolate belonging to serovar shandongiensis revealed at least three potent toxicity on human leukaemic T cells [10], [11].

## 1.2. The discovery of PSs

Parasporins are the type of  $\delta$ -endotoxins produced as Cry proteins by *Bt* species. The most prominent feature of parasporins is that they don't exhibit insecticidal activity but prefer cancer cells to control. They are firstly discovered in non-haemolytic and non-insecticidal *B. thuringiensis* isolates A1519 and A1190 by Mizuki et al. [12] after an extensive scanning programme and named as parasporin proteins. Studies revealed that they have cytotoxic activity on leukemic T cells and some other human cancer cells [7]. The first discovered protein was named as PS1Aa1 [8], and discovery of new proteins are followed by scientists in Vietnam [13], Canada [14], Malaysia [15] and Japan [16]. It was indicated that spore morphology and some other characteristic properties of parasporin producing *Bt* strains are different from their Cry producing counterparts [17]. Parasporins exerts their cytotoxicity on cells without any serious deterioration on the cell surface. It was reported that parasporins thought to have disruptive effect on cells via more specific mechanism other than known colloidal-osmotic swelling of cells and fragmentation caused by Cry proteins [18].

In a screening study carried out on sheep erythrocytes, potent proteins was obtained from more than 60 *Bt* isolates with strong haemolytic effect on organisms ranging from vertebrates to invertebrates [19]. Likewise, some of the parasporins with non-haemolytic and non-insecticidal activity was found to have cytotoxic effect against MOLT-4 (human leukemic T-cells) [12]. When PS1A1 was applied to cell lines from mosquito (*Aedes albopictus*) cultures (NIASAE1-2) and cells from *B. mori* (BM-N), sensitivity was not observed [7]. However, in more detailed studies using parasporins high cytotoxic effect was observed on HeLa, MOLT-4 and human lung cancer cells at various levels [12]. Such a situation revealed that parasporins have varying degrees of specificity on a wide variety of cancer cells.

## 1.3. Mode of action and target specificity

High doses of parasporins result in cessation of respiratory activity in variety of cells (Caco-2, MOLT-4, HL60, Jurkat, HC TCS, HepG2, MRC-5, Sawano, HeLa and A549) following large morphological alterations and subsequently swell, begin to separate from holder and come apart before cell death is realized [20]. Due to death of the cells at high doses before the start of apoptosis, these morphological events are the indication that cytotoxicity is not an apoptotic result. The researchers also specified that every toxin protein have unique and specific target spectrum in mammalian cells because of their receptor recognition property.

Wong et al. [21] studied the binding behavior of purified parasporins and put forth that product of *Bt* 18 has quite high affinity against CEM-SS (leukaemic cell line) cells. Heterologous competitive binding analysis revealed that parasporins attach to distinct positions in different cancer cells and thus may have disparate mode of action. PS1 group of proteins demonstrate their cytotoxic effect through apoptosis [22]. PS1Aa3 and PS1Ab1 without any insecticidal and haemolytic effect, indicate a considerable toxicity on HeLa cells (human uterus cervix cancer cells), but, not on uterine smooth muscle cells (UTSMC) [23]. In studies with simultaneous application of parasporal proteins and commercial anticancer drugs as doxorubicin, cisplatin, navelbine, etoposide, and methotrexate on CEM-SS cell lines, competitive relation was not reported. That's why it has great importance to clarify *in vitro* differential activity mechanism of every parasporin on different types of cancer cell lines.

Cytotoxic action was not evident upon application of 16 and 60 kDa parts of PS1Ac2 separately on HeLa and MOLT-4 cells, however, their mixed application resulted in cytotoxicity on HeLa cells but not on MOLT-4 cells [24]. Such a case has been attributed to refolding activity of proteins. These researchers suggested that depending on the lack of intracellular LDH release, the mode of action of PS1Ac2 was not associated with pore formation in cell membrane, but directly related with the start of apoptotic signal in susceptible cells through  $Ca^{+2}$  influx. While PS2Aa1, PS3Aa1 and PS4Aa1 exhibit their cytotoxicity in 1h on susceptible cells, PS1Aa1 reveal in 8-10h on the same cell types [25], [26]. The situation show that parasporal proteins can structurally be different from each other and reveals that mode of action of PS1Aa1 was considerably different from other parasporins [7]. PS1Aa1 doesn't cause pore formation in cell membrane but rapidly increase the concentration of intracellular  $Ca^{+2}$  concentration and physiologically result in a considerable decrease in DNA and protein synthesis [22].

PS2 structurally resemble to aerolysin-type  $\beta$ -pore-forming toxins [27] and exerts its cytotoxic effect through lysing the cells [28]. But PS2 may also induce caspase activity at low doses [20]. The first step of PS2Aa1 in cytotoxicity is its specific connection with an undetermined putative receptor in cell membrane and increase in membrane permeability. With the production of PS2Aa1 oligomers, pores are formed and cells become lysed [9]. Despite the lack of detailed information about the mode of action of PS3Aa1, the 3-domain structure of this protein as in Cry proteins suggest that it can perform the cytotoxic effect on cancer cells through pore formation [26]. In some data it was stated that PS4 has pore forming activity similar to PS2 [29], but, these two proteins have different target cell spectrum and exhibit varied cytotoxic activity mechanisms [30]. Sensitive CACO-2 and MOLT-4 cells and resistant HeLa cells were subjected to various concentrations of PS4 and seen that wide pore formation on target cell membranes were induced [29]. PS4Aa1 differs from other parasporins in many aspects and also thought that it has different mechanism in terms of mode of action [9]. However, there is no detailed information as in PS3.

## 1.4. Types and specifications of parasporins

Parasporins are characterized by their non-hemolytic but preferentially cancer killing properties. So far as noted in Table 1, a total of 19 parasporin proteins have been isolated from 17 *Bt* strains and classified into 6 groups as PS1-PS6 [8]. Parasporins need to be activated proteolytically for exhibiting toxicity on cancer cells [20]. PS1, PS3, and PS6 are three domain proteins with five block conserved sequences. PS1 is the most well studied protein with 81kDa precursor structure and 15-56 kDa active heterodimer [27]. PS3 is similar to PS1 with 88 kDa inactive and 64 kDa active form [26]. PS6 is a protein with 84 kDa inactive form and 73kDa active form with 14-56kDa heterodimers [31]. On the other hand, PS2 is a low molecular weight (37 kDa precursor, 30kDa active form) protein with unconserved three-domain structure [27]. PS4 is the protein with molecular weight of 30 kDa inactive form and 27 kDa proteolytically activated form [32]. PS5 is also low molecular weight protein which lack five block conserved sequences [27].

Table 1: Known parasporin proteins

Type of Parasporin	Corresponding Cry No.	<i>Bt</i> source strain	Reference
Parasporin 1	PS1Aa1	Cry31Aa1	A1190 [7]
	PS1Aa2	Cry31Aa2	M15 [14]
	PS1Aa3	Cry31Aa3	B195 [33]
	PS1Aa4	Cry31Aa4	Bt 79-25 [34]
	PS1Aa5	Cry31Aa5	Bt 92-10 [34]
	PS1Aa6	Cry31Aa6	CP78A, M019 [31]
	PS1Ab1	Cry31Ab1	B195 [33]
	PS1Ab2	Cry31Ab2	Bt 31-5 [34]
	PS1Ac1	Cry31Ac1	Bt 87-29 [34]
	PS1Ac2	Cry31Ac2	B0462 [24]
	PS1Ad1	Cry31Ad1	CP78B, M019 [31]
Parasporin-2	PS2Aa1	Cry46Aa1	A1547 [20]
	PS2Aa2	Cry46Aa2	A1470 [35]
	PS2Ab1	Cry46Ab1	TK-E6 [36]
Parasporin-3	PS3Aa1	Cry41Aa1	A1462 [26]
	PS3Ab1	Cry41Ab1	A1462 [26]
Parasporin-4	PS4Aa1	Cry45Aa1	A1470 [37]
Parasporin-5	PS5Aa1	Cry64Aa1	A1100 [27]
Parasporin-6	PS6Aa1	Cry63Aa1	CP84, M019 [31]

Available at: <http://parasporin.fitc.pref.fukuoka.jp/list.html>

## 1.5. Haemolytic and cytotoxic effects of PSs

There are large number of isolates without haemolytic activity and high selective toxicity to a wide variety of mammalian cells lines. For example, while PS2Aa1 selectively kill liver and colon cancer cells, it didn't exert cytotoxicity on non-neoplastic cells, chronic inflammatory cells or blood vessels in the same organism [20]. Cytotoxicity spectrum of parasporins from these isolates exhibit heterogeneity. While some of them have toxicity over a wide range of human cells, others are strictly specific to few cells [38]. Ito et al. [20] revealed that cytotoxicity levels of recombinant parasporin vary from cell to cell. Among the cells that they examined, while the highest toxicity was observed on MOLT-4, Jurkat, Sawano, and HepG2 with 10–40 ng/ml concentrations, MRC-5, HC, TCS, A549, and HeLa cells were reported to be resistant. Nevertheless, a clear common characteristic among susceptible and resistant cell lines couldn't identified, but, it was clear that tumor cells are more sensitive compared to normal cells.

Different anti-cancer cytotoxicity spectrum and activity levels of parasporins on human cell lines are their most striking features. Some PS2 and PS4 types reported to have broad spectrum of activity through indicating lethal effect on six of the nine cancer lines [20], [22], [26], [32]. However, PS3 exhibits moderate cytotoxicity with narrow spectrum in a limited number of cancer cells. It is also interesting that Jurkat, TCS and HeLa cell lines were reported to have monosensitivity against one of PS1Aa1, PS2Aa1 and PS4Aa1 [20].

In a study carried out with recombinant PS5, while quite high toxicity ( $EC_{50} < 0.1 \mu\text{g/mL}$ ) were evidenced on HepG2, COS7, HeLa, MOLT -4, TCS, Vero, and Sawano cells, weak toxicity ( $EC_{50}$ , 0.1 to 1  $\mu\text{g/mL}$ ) was seen on Jurkat, CACO-2, NIH3T3, MRC-5, CHO-K1, and UtSMC cells. On the other hand, cytotoxic activity was not observed on U937 and HC cells ( $EC_{50} > 10 \mu\text{g/mL}$ ) [27]. Therefore, a determined specific toxicity mechanism was not proposed for PS5.

## 2. CONCLUSIONS

Bacterial parasporins provide promising results for decelerating or preventing the proliferation of cancer cells. In this respect, parasporal proteins with different activity spectrum on cancer cell lines can be obtained from a variety of bacterial species. Thus, screening studies should be conducted to find new putative parasporins and their mechanisms of cytotoxicity have to be elucidated on variety of cancer cell lines.

## REFERENCES

- [1] C. Johnson and A. H. Bishop, "Bacillus thuringiensis," in *Mortality*, vol. 144, no. 71, 1998, pp. 138–144.
- [2] A. I. Aronson and Y. Shai, "Why Bacillus thuringiensis insecticidal toxins are so effective: unique features of their mode of action," *FEMS Microbiol. Lett.*, vol. 195, pp. 1–8, 2001.
- [3] S. Ishiwata, "On a new type of severe flacherie (sotto disease) (original in Japanese)," *Dainihon Sansi Kaiho*, vol. 114, no. 114, pp. 1–5, 1901.
- [4] S. Yilmaz, "Molecular characterization of Bacillus thuringiensis strains isolated from different locations and their effectiveness on some pest insects," Erciyes university, 2010.
- [5] M. P. Meadows, D. J. Ellis, J. Butt, P. Jarrett, and H. D. Burges, "Distribution, Frequency, and Diversity of Bacillus thuringiensis in an Animal Feed Mill," *Appl. Environ. Microbiol.*, vol. 58, no. 4, pp. 1344–50, Apr. 1992.
- [6] M. Ohba and K. Aizawa, "Distribution of Bacillus thuringiensis in soils of Japan," *J. Invertebr. Pathol.*, vol. 47, no. 3, pp. 277–282, 1986.
- [7] E. Mizuki, Y. S. Park, H. Saitoh, S. Yamashita, T. Akao, K. Higuchi, and M. Ohba, "Parasporin, a Human Leukemic Cell-Recognizing Parasporal Protein of Bacillus thuringiensis," *Clin. Diagn. Lab. Immunol.*, vol. 7, no. 4, pp. 625–634, 2000.
- [8] S. Okumura, M. Ohba, E. Mizuki, N. Crickmore, J.-C. Côté, Y. Nagamatsu, S. Kitada, H. Sakai, K. Harata, and T. Shin, "Parasporin nomenclature," 2010. [Online]. Available: <http://parasporin.ftcc.pref.fukuoka.jp/>.
- [9] M. Ohba, E. Mizuki, and A. Uemori, "Parasporin, a new anticancer protein group from Bacillus thuringiensis," *Anticancer Res.*, vol. 29, no. 1, pp. 427–433, 2009.
- [10] D. Lee, H. Katayama, T. Akao, and M. Maeda, "A 28 kDa protein of the Bacillus thuringiensis serovar shandongensis isolate 89-T-34-22 induces a human leukemic cell-specific cytotoxicity," vol. 1547, pp. 57–63, 2001.
- [11] D. W. Lee, T. Akao, S. Yamashita, H. Katayama, M. Maeda, H. Saitoh, E. Mizuki, and M. Ohba, "Noninsecticidal parasporal proteins of a Bacillus thuringiensis serovar shandongensis isolate exhibit a preferential cytotoxicity against human leukemic T cells," *Biochem. Biophys. Res. Commun.*, vol. 272, no. 1, pp. 218–223, 2000.
- [12] E. Mizuki, M. Ohba, T. Akao, S. Yamashita, H. Saitoh, and Y. S. Park, "Unique activity associated with non-insecticidal Bacillus thuringiensis parasporal inclusions: In vitro cell-killing action on human cancer cells," *J. Appl. Microbiol.*, vol. 86, no. 3, pp. 477–486, 1999.
- [13] K. Yasutake, N. D. Binh, K. Kagoshima, A. Uemori, A. Ohgushi, M. Maeda, E. Mizuki, Y. M. Yu, and M. Ohba, "Occurrence of parasporin-producing Bacillus thuringiensis in Vietnam," *Can. J. Microbiol.*, vol. 52, pp. 365–372, 2006.
- [14] Y. C. Jung, E. Mizuki, T. Akao, and J. C. Côté, "Isolation and characterization of a novel Bacillus thuringiensis strain expressing a novel crystal protein with cytotoxic activity against human cancer cells," *J. Appl. Microbiol.*, vol. 103, no. 1, pp. 65–79, 2007.
- [15] V. D. Nadarajah, D. Ting, K. K. Chan, S. M. Mohamed, K. Kanakeswary, and H. L. Lee, "Selective cytotoxic activity against leukemic cell lines from mosquitoicidal Bacillus thuringiensis parasporal inclusions," *Southeast Asian J. Trop. Med. Public Health*, vol. 39, no. 2, pp. 235–245, 2008.
- [16] A. Uemori, M. Maeda, K. Yasutake, A. Ohgushi, K. Kagoshima, E. Mizuki, and M. Ohba, "Ubiquity of parasporin-1 producers in Bacillus thuringiensis natural populations of Japan," *Naturwissenschaften*, vol. 94, no. 1, pp. 34–38, 2007.
- [17] M. Ichikawa, A. Uemori, A. Ohgushi, and K. Yasutake, "Phenotypic and Morphometric Characterization of Bacillus thuringiensis Parasporin – 1 Producers: A Comparison with Insecticidal Cry – rotein Producers," *Science (80-. )*, vol. 52, no. 2, pp. 307–313, 2007.
- [18] A. Namba, M. Yamagiwa, H. Amano, T. Akao, E. Mizuki, M. Ohba, and H. Sakai, "The cytotoxicity of Bacillus thuringiensis subsp. coreanensis A1519 strain against the human leukemic T cell," *Biochim. Biophys. Acta - Gen. Subj.*, vol. 1622, no. 1, pp. 29–35, 2003.
- [19] B. H. Knowles, P. J. White, C. N. Nicholls, and D. J. Ellar, "A broad-spectrum cytolytic toxin from Bacillus thuringiensis var. kyushuensis," *Proc. Biol. Sci.*, vol. 248, no. 1321, pp. 1–7, Apr. 1992.
- [20] A. Ito, Y. Sasaguri, S. Kitada, Y. Kusaka, K. Kuwano, K. Masutomi, E. Mizuki, T. Akao, and M. Ohba, "A Bacillus thuringiensis crystal protein with selective cytotoxic action to human cells," *J. Biol. Chem.*, vol. 279, no. 20, pp. 21282–21286, 2004.
- [21] R. S. Y. Wong, S. M. Mohamed, V. D. Nadarajah, and I. A. T. Tengku, "Characterisation of the binding properties of Bacillus thuringiensis 18 toxin on leukaemic cells," *J. Exp. Clin. Cancer Res.*, vol. 29, no. 1, p. 86, Jan. 2010.
- [22] H. Katayama, H. Yokota, T. Akao, O. Nakamura, M. Ohba, E. Mekada, and E. Mizuki, "Parasporin-1, a novel cytotoxic protein to human cells from non-insecticidal parasporal inclusions of Bacillus thuringiensis," *J. Biochem.*, vol. 137, no. 1, pp. 17–25, 2005.
- [23] A. Uemori, A. Ohgushi, K. Yasutake, M. Maeda, E. Mizuki, and M. Ohba, "Parasporin-1Ab, a novel Bacillus thuringiensis cytotoxin preferentially active on human cancer cells in vitro," *Anticancer Res.*, vol. 28, no. 1 A, pp. 91–96, Jan. 2008.
- [24] S. Kuroda, A. Begum, M. Saga, A. Hirao, E. Mizuki, H. Sakai, and T. Hayakawa, "Parasporin 1Ac2, a Novel Cytotoxic Crystal Protein Isolated from Bacillus thuringiensis B0462 Strain," *Curr. Microbiol.*, vol. 66, no. 5, pp. 475–480, 2013.
- [25] H. Saitoh, S. Okumura, T. Ishikawa, T. Akao, E. Mizuki, and M. Ohba, "Investigation of a Novel Bacillus thuringiensis Gene Encoding a Parasporal Protein, Parasporin-4, That Preferentially Kills Human Leukemic T Cells," *Biosci. Biotechnol. Biochem.*, vol. 70, no. 12, pp. 2935–2941, 2014.
- [26] S. Yamashita, H. Katayama, H. Saitoh, T. Akao, Y. S. Park, E. Mizuki, M. Ohba, and A. Ito, "Typical three-domain cry proteins of Bacillus thuringiensis strain A1462 exhibit cytotoxic activity on limited human cancer cells," *J. Biochem.*, vol. 138, no. 6, pp. 663–672, 2005.
- [27] K. Ekino, S. Okumura, T. Ishikawa, S. Kitada, H. Saitoh, T. Akao, T. Oka, Y. Nomura, M. Ohba, T. Shin, and E. Mizuki, "Cloning and characterization of a unique cytotoxic protein parasporin-5 produced by Bacillus thuringiensis al100 strain," *Toxins (Basel)*, vol. 6, no. 6, pp. 1882–1895, 2014.
- [28] Y. Abe, H. Shimada, and S. Kitada, "Raft-targeting and oligomerization of parasporin-2, a Bacillus thuringiensis crystal protein with anti-tumour activity," *J. Biochem.*, vol. 143, no. 2, pp. 269–275, 2008.
- [29] S. Okumura, H. Saitoh, T. Ishikawa, K. Inouye, and E. Mizuki, "Mode of action of parasporin-4, a cytotoxic protein from Bacillus thuringiensis," *Biochim. Biophys. Acta - Biomembr.*, vol. 1808, no. 6, pp. 1476–1482, 2011.
- [30] K. Inouye, S. Okumura, and E. Mizuki, "Parasporin-4, a novel cancer cell-killing protein produced by Bacillus thuringiensis," *Food Sci. Biotechnol.*, vol. 17, no. 2, pp. 219–227, 2008.
- [31] Y. Nagamatsu, S. Okumura, H. Saitoh, T. Akao, and E. Mizuki, "Three Cry Toxins in Two Types from Bacillus thuringiensis Strain



- M019 Preferentially Kill Human Hepatocyte Cancer and Uterus Cervix Cancer Cells," *Biosci. Biotechnol. Biochem.*, vol. 74, no. 3, pp. 494–498, 2010.
- [32] S. Okumura, H. Saitoh, T. Ishikawa, N. Wasano, S. Yamashita, K. I. Kusumoto, T. Akao, E. Mizuki, M. Ohba, and K. Inouye, "Identification of a novel cytotoxic protein, Cry45Aa, from *Bacillus thuringiensis* A1470 and its selective cytotoxic activity against various mammalian cell lines," *J. Agric. Food Chem.*, vol. 53, no. 16, pp. 6313–6318, 2005.
- [33] M. Uemori, A. Ohgushi, A. Maeda, M. Mizuki, E. and Ohba, "Cloning and Characterization of parasporin-1 genes of *Bacillus thuringiensis* Strain B0195." Unpublished. <https://www.ncbi.nlm.nih.gov/protein/88687360>
- [34] M. Yasutake, K. Uemori, A. and Ohba, "Characterization of cancer cell-killing *Bacillus thuringiensis* in Vietnam." [Online]. Available: <https://www.ncbi.nlm.nih.gov/protein/114842167>.
- [35] S. Okumura, T. Ishikawa, H. Saitoh, T. Akao, and E. Mizuki, "Identification of a second cytotoxic protein produced by *Bacillus thuringiensis* A1470," *Biotechnol. Lett.*, vol. 35, no. 11, pp. 1889–1894, 2013.
- [36] T. Hayakawa, R. Kanagawa, Y. Kotani, M. Kimura, M. Yamagiwa, Y. Yamane, S. Takebe, and H. Sakai, "Parasporin-2Ab, a newly isolated cytotoxic crystal protein from *Bacillus thuringiensis*," *Curr. Microbiol.*, vol. 55, no. 4, pp. 278–283, 2007.
- [37] S. Okumura, H. Saitoh, N. Wasano, H. Katayama, K. Higuchi, E. Mizuki, and K. Inouye, "Efficient solubilization, activation, and purification of recombinant Cry45Aa of *Bacillus thuringiensis* expressed as inclusion bodies in *Escherichia coli*," *Protein Expr. Purif.*, vol. 47, no. 1, pp. 144–151, 2006.
- [38] N. a Logan, "Bacillus anthracis, *Bacillus cereus*, and other aerobic endospore-forming bacteria," *Topley Wilson's Microbiol. Microb. Infect.*, vol. 1–2, pp. 922–952, 2010.

# Comparison studies of e-learning LMS'es in higher education institutions in the Republic of Macedonia

*Shkurte Luma-Osmani*<sup>1</sup>, *Florim Idrizi*<sup>1</sup>, *Artrim Kjamilji*<sup>2</sup>

---

## Abstract

A variety of systems that support e-learning are available to help organizations manage courses and provide for the learners' ways to organize, update, store content and enable ease of administration. All of these systems are progressive and their main task is helping companies or educational centers improve their productivity, efficiency and customer/students services. Indeed, Bologna's summit guidelines regarding the Bachelor/Master structure, which is currently used in most colleges and universities, were mostly aimed at standardizing the educational system in European higher education. Educational institutions use these guidelines as a basis for setting up their educational model. However, different educational institutions in our country are at different stages in implementing new learning models. The results showed that higher education institutions preparation stage regarding the application of e-learning, whereas private ones have applied this system since their foundation, and use it on daily basis where they perform all the services. They are a step forward related to demand-based learning that means giving the student more freedom of choice in his or her learning program.

**Keywords:** e-learning, higher education in Republic of Macedonia, learning management system

---

## 1. INTRODUCTION

Over time, different developments have had varying influences in higher education. Indeed, developments are pushing educational institutions to react and become accustomed. One of the outcomes is that these institutions are elevated from traditional ways of teaching towards new teaching models. In this research, an argument is put forward for academics to take a practical role in the development and use of technology in the teaching process. The application that we aim to create, that mainly focuses on professor-student communication, is an automated system that simplifies the activities like distribution of learning materials that meets their needs or collection of student class work and homework paperlessly. They can also access the files related to certain subjects, announcements and other relevant information that have to do with the teaching process, from wherever they have access to a computer and Internet connection.

## 2. E-LEARNING TOOLS

Let us look at three of the widely available applications designed to provide ways to manage various aspects of e-Learning content:

- Learning Management System
- Content Management System
- Learning Content Management System

Content Management Systems (CMS), Learning Management Systems (LMS), and Learning Content Management Systems (LCMS) enterprise applications are often found to be competing for the same organization resources. The reality is that each application has very specific strengths and abilities that may complement each other; but one often is the best fit [1].

Learning Management System is a software application, which allows instructors to create online training courses. It deals with creating, managing and delivering e-courses as well as provides learners online classrooms where they can interact and learn in an interactive environment. In order to create such an environment, LMS allows instructors to upload their courses and learning materials such as videos, presentations, PDFs and so forth. This software has a number of features that allow users to access these materials at any time, even after they have finished taking the courses, ensuring continuity and uniformity in learning and training.

Both, free LMSs and commercial LMSs exist. The most used ones are the free ones even though this does not imply that they have an inferior quality. In addition, they are more complete than the commercial ones. Nevertheless, some institutions prefer

---

<sup>1</sup> Faculty of Natural Sciences and Mathematics, University of Tetova, Tetovo, Macedonia, [shkurte.luma@unite.edu.mk](mailto:shkurte.luma@unite.edu.mk)  
[florim.idrizi@unite.edu.mk](mailto:florim.idrizi@unite.edu.mk)

<sup>2</sup> Faculty of Engineering and Natural Sciences, Dept. of Computer Science & Engineering, Sabanci University, Turkey,  
[artrimk@sabanciuniv.edu](mailto:artrimk@sabanciuniv.edu)

commercial ones since they are configured and supervised by the company. Among free LMSs, Claroline, Dokeos, and Moodle are mostly used. Among commercial LMSs we can find WebCT and Blackboard [2].

Quoad to the companies, the software application in question saves travel and lodging expenses since they can create training programs and reuse the same in order to train multiple groups of employees. It is a piece of software which gathers together into one box a lot of facilities that can be used to deliver online education courses, just like Gmail helps you send emails. It is widely used by businesses of all sizes, various organizations or government agencies, schools, universities or colleges.

CMS is a type of software that allows users to create and manage content, with the purpose of creating something useful, usually a website, without having advanced programming skills. This gives the user an easier way of adding or deleting any type of content, for instance Joomla or Wordpress platforms. The primary user in CMS software is the content developer. Content refers to the type of information that CMS allows us to manage.

CMS is used for sharing files or information in order to show the content to the world. It may include documents, pictures, audio or video files. Another important aspect of CMS is that it can support content being created once and used many times. An example is the image that is used in several different newspaper articles targeted at different audiences [1].

In addition to this, CMS describes a method of administration content workflow online, because it has changed the way people think about and control content in websites, with the main aim to create and publish a blog or complex web site that is used to offer different kind of product and services.

Learning Content Management System (LCMS) can be counted as a compound, hybrid of two of the above-mentioned software applications. It provides a multi-user environment, used to create stored organized e-learning content. Beside this, LCMS can be used to develop, publish and manage learning objects. These objects are seen as a small re-usable unit of content and their aim is to be reused in other applications as well, therefore saving time and money. Moreover, LCMS saves money to the companies or other institutions when it is used to rapidly develop new e-learning courses using existing classroom-based content while updating and modifying only the content that needs to be updated. In this case, money is saved on two fronts: by saving the time and resources used in delivering classroom-based courses to thousands of learners and by decreasing time to productivity for the agents [3]. Within LCMS user roles can be assigned, based on the tasks they have to perform, starting from the content creator to the end user.

According to a survey made in the University of Granada, Spain [4], 58 research papers were analyzed, by creating a list of recommended packages, marking as well as how many times each one was recommended. One point is given for every recommendation, but in case the study recommended two packages, then each one takes half a point (see table 1).

Table 1: Package Recommendation

Name	Frequency
WebCT	9
Blackboard	4,5
Moodle	4
ATutor	2
Brix	1
EMU-LMS	1
FirstClass	1
Ilias	1
Janison	1
TopClass	0,5
Total	20

Based on the results, WEBCT is the most recommended package while Blackboard occupied the second and Moodle the third place, as illustrated below. It is important to note that in comparison with the open source platforms, Moodle is the most recommended one.

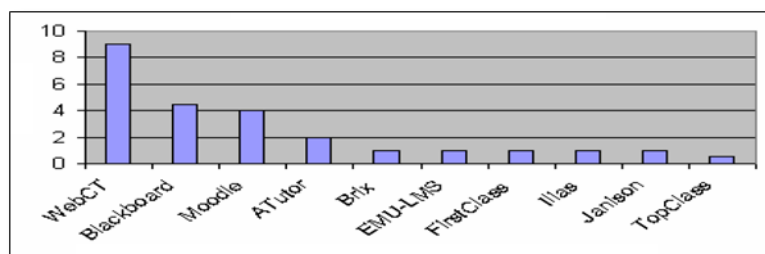

Figure 1: Package Recommendation

### 3.E-LEARNING IN HIGHER EDUCATION INSTITUTIONS IN MACEDONIA

Researchers all over the world have made different studies associated with the impact of application of new technologies in the learning process by using e-resources. Nevertheless, in our country, when it comes to implementing new changes, difficulties appear. Higher education institutions worldwide use learning applications such as Blackboard, Moodle and Teletop [5].

Sinani [6] alleges that while in primary and secondary schools the computer is used as a tool for increasing the knowledge and essential skills, in higher education institutions besides this purpose; it is also used with complex, sophisticated software dedicated for students and professors. Zamfir [7] also agrees that higher education institutions are highly involved into knowledge creation, diffusion and learning. University's competitive ability depends on institutional opportunity to share, spread and adapt knowledge.

Related to higher education institutions in Macedonia, the first-ranked public University "Ss. Cyril and Methodius" [8] has no unified electronic learning management system for e-learning. However, it uses software named "iKnow" which supports student services only, mostly exam enrolment, but does not include professor-student communication side.

Another example of the institution that uses e-learning concept is the public University "Goce Delcev" in Shtip [9]. The implementation of e-learning in this institution began in 2007 by using Moodle platform. According to a study [10], more than 400 courses have been created in this platform. The courses are available to professors and students. The course creators keep proper attention and control to the content, activities and students enrolled into it.

The private university "South East European University" [11] uses an LMS named LIBRI which is available to the university community to deliver and conduct their courses through web. It facilitates instructors in carrying out course related activities through web including course content delivery, communication, collaboration, and assessment. LIBRI is a flexible and feature rich course development system. This provides freedom and control to the course designers and is thus used with a number of course at the university. However, in the academic year 2015-2016 Google Classroom was also introduced and as such, it will be the primary (and probably the only) LMS at SEE University in the future.

Another private University in Macedonia, "FON" uses an e-learning system, which is closed for broader use, respectively is limited only to the employees and students who log in with their university email address [12].

Our case study is the newest public University in the Republic of Macedonia, i.e. the "University of Tetova". Currently it does not use any kind of learning management systems and the whole process of learning activities is made manually.

Therefore, as related several higher education institutions in the Republic of Macedonia, the need for a new learning management system to educational innovation was highlighted, acknowledging the difference between five universities that were chosen, both public and private ones, exemplifying the Macedonian higher education context with the intention of having deeper knowledge about the current situation of e-learning in our country. This was the main reason that pushed us in creating a new application presented as a learning management system. It has its own users and every user has certain roles in the application.

#### 4.USER ROLES

According to the functions that each user should execute, we have created three users: administrator, professor and student. A clear clarification and definition of each user roles and accesses is given in the sub-chapters.

The actors as concerned our application are admin (administrator), professor and student. Whereas the cases are user registration, update, search, verification, add professor or student, modify and delete data, and upload files. The use case diagram of this automated system, student – professor communication is given in figure 2.

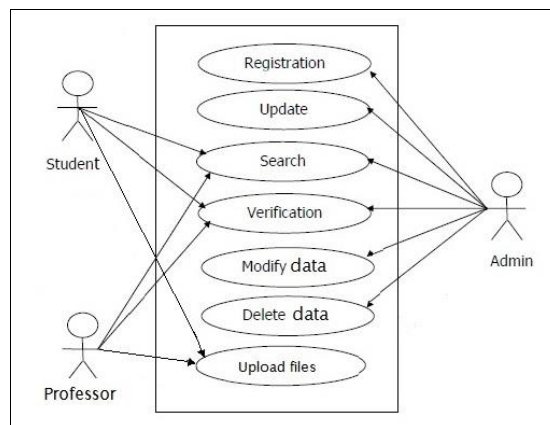

Figure 2: Use Case Diagram

#### Administrator

The administrator's main function is to register professors on the application. S/He can also list all of the professors, enable or disable them, according to the current employment status of the professor. If the professor has a disabled status, then he cannot log in into the application, until the administrator changes his status back to active.

Welcome Admin Logout							
All Professors							
Add new Professor							
First Name	Last Name	Email	City	Country	Username	Status	Action
Shkurte	Luma	shkurte.luma@gmail.com	Tetovo	Macedonia	shkurte	Active	Disable
Bekim	Fetaji	bekim.fetaji@seeu.edu.mk	Gostivar	Macedonia	bekim	Active	Disable

Figure 3: List of all Professors

Thus, besides activating and deactivating professors, the administrator can also register new ones. In order to complete the registration, information such as Professor's Name, Surname, Email, Phone Number, Address, City, Country, Username and Password must be provided. It is displayed on the below interface.

Welcome Admin Logout	
<b>Add New User</b>	
*Required Field	
Enter Name <input type="text" value="Enter Name"/>	Enter City <input type="text" value="Enter City"/>
Enter Surname <input type="text" value="Enter Surname"/>	Enter Country <input type="text" value="Enter Country"/>
Enter Email <input type="text" value="Enter Email"/>	Enter Username <input type="text" value="Enter Username"/>
Enter Phone <input type="text" value="Enter Phone Number"/>	Enter Password <input type="text" value="Enter Password"/>
Enter Address <input type="text" value="Enter Address"/>	<input type="button" value="Cancel"/> <input type="button" value="Submit"/>

Figure 4: Add New Professor

## Professor

When the professor logs into his account, he should add new classes into his blank interface. A white cross button link appears on the top right side of the interface that enables the creation of a new class. The information requested for this action is the class name as well as class description.

Classroom	+	Welcome Shkurte Luma	Logout
<b>Add Class</b>			
*Required Field			
Enter Class Name <input type="text" value="Web Design"/>			
Enter Class Description <input type="text" value="Here you will find all the materials you need to study in the subject of Web Design."/>			
<input type="button" value="Back"/>			<input type="button" value="Submit"/>

Figure 5: Add New Class

Figure 6 shows the add announcement operation. Course announcements can be used by the professor to inform the students about different kinds of news. A dialog form will appear requesting the Announcement title and its description. When clicked submit, it will be stored on the announcement list displayed on the right side of the screen. When no longer needed, it can be deleted.

Figure 6: Add New Announcement

The professor has access to the list of all students; after this, he can choose the students he wants to attend the course. The same announcement will also appear on the screen of every student enrolled in this class.

All Students		Registered Students	
First Name	Last Name	First Name	Last Name
Lejla	Murtezani	Nita	Jakupi
Rita	Ismaili	Sara	Luma

Figure 7: Enroll Students into Courses

The upload tab is responsible for downloading/uploading files from the computer's disk drive into the application. The course's owner has the opportunity to upload and delete materials in electronic form. By using the web, application members are allowed to gather their teacher's files from anywhere where Internet access is available.

Figure 8: Upload New File

Tab Grades contains the files that students upload, mostly homework. After reviewing, the professor grades the student's work and saves it. The same mark will appear on the student's screen.

First Name	Last Name	File Name	Description	Grade
Nita	Jakupi	HomeWork.docx	Home Work - Web Design.	8

Figure 9: Students grading

## Student

If the student is logging in for the first time in the application, a message as shown in Figure 10 will appear, notifying that s/he is not enrolled in any class. S/he can be enrolled by searching the course code, assuming that the professor has already given it to them in the class.

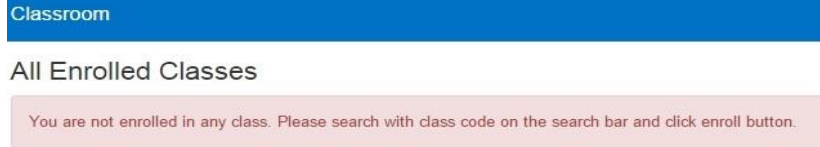

Figure 10: All enrolled classes

Figure 11 illustrates the announcements that the professor has posted through his account and is available on the students interface. Furthermore, the announcements will be sent as an email to the enrolled student's email address, as shown in figure 12.

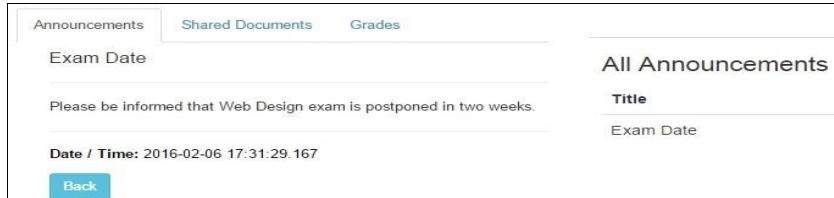

Figure 11: Announcement Posting



Figure 12: Email Receipt

The subject materials that the professor has shared with students are available on the Shared Documents tab of the students interface. We should take in consideration that this process is bilateral since the student can also upload files and they will appear on the professor's screen.

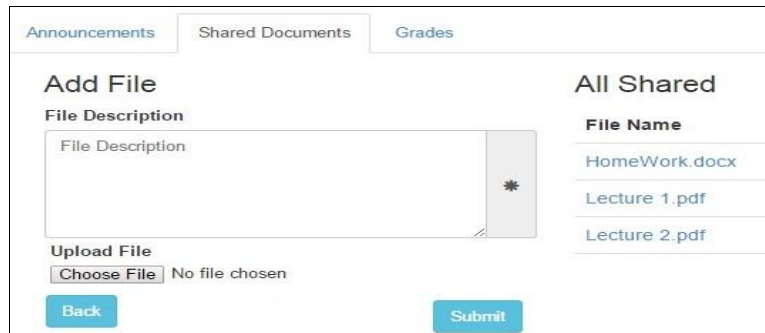

Figure 13: Student Upload/Download Files

As soon as the professor uploads a mark into the file that student has provided, that grade will be available on the student Grades screen.

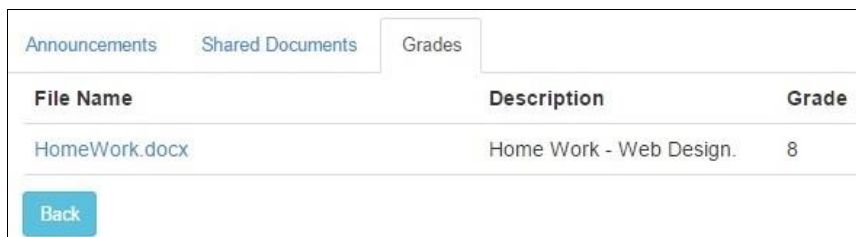

Figure 14: Student Grade Screen

A clear presentation of all the above mentioned roles and tables is given in the following entity-relationship diagram of the web server database (figure 15).

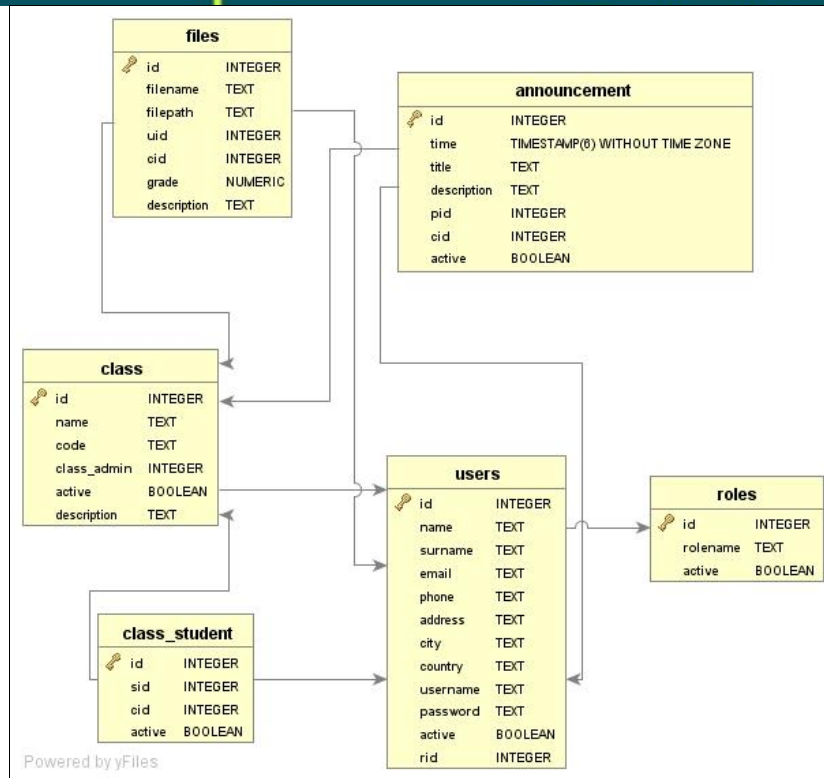

Figure 15: Entity-Relationship Diagram

## 5.CONCLUSIONS

Web applications play a significant role in facilitating student and teacher support processes in modern education. This paper elaborates the use of technology in delivering teaching where web-based technologies for work related activities have taken a major part. The advantages of this web application are 24/7 accessibility, flexibility of use, facilitation of student-professor direct communication in various forms, and exposure to current information. Users who are part of the application are also presented. They can be categorized into three groups: administrator, course owners (professors, teachers) and participants of the courses' (students). Each one of the user has its own privileges, functions and roles in the application.

## ACKNOWLEDGMENT

The co-author, Artrim Kjamliji would like to acknowledge the contribution of the Scientific and Technological Research Council of Turkey (TÜBİTAK).

## BIOGRAPHY



Shkurte Luma-Osmani was born on 27<sup>th</sup> September 1988 in Kosovo. She has finished her primary and secondary education in Tetovo. She completed her bachelor's degree in Informatics Department in the Faculty of Mathematical and Natural Sciences of the University of Tetova in December 2011. In September 2012 she enrolled her master's studies in the department of Software Application and Development at the Faculty of Contemporary Science and Technologies at the SEEU, where she managed to pass all exams with success and finished the same in July 2016. From March 2014 is engaged in the Office for Scientific Research and Innovation of the University of Tetova, whereas from September 2014, also works as a new Teaching Assistant on the department of Informatics, on subjects like: Information Technology, Ethics in IT, Introduction to Programming, Web Design, and Database Management. She is fluent in Albanian, Macedonian and English and has basic knowledge of Spanish and German.

Her skills also involve Programming Languages: C#, C++, Java, Database: MS SQL Server, MySQL, PostgreSQL, MS Access and Web technologies: HTML & CSS, ADO.NET, ASP.NET, PHP.

## REFERENCES

- [1] Irlbeck, S. and Mowat, J. (2007). *Learning Objects: Standards, Metadata, Repositories, and LCMS*. Santa Rosa, California: Informing Science Press. p.157-184.
- [2] [] Ninoriya, S., Chawan, P.M. and Meshram, B.B. (2011). *CMS, LMS and LCMS For eLearning*. IJCSI-International Journal of Computer Science Issues, vol. 8, Issue 2, pp.646-647. ISSN: 1694-0814, Available at [www.IJCSI.org](http://www.IJCSI.org).



- [3] Brennan, M. Funke, S. and Anderson, C. (2001). The Learning Content Management System. A New eLearning Market Segment Emerges. p. 8. Framingham: IDC.
- [4] Itmazi, J.A. and Megias, M.G. (2005). *Survey: Comparison and evaluation studies of learning content management systems*. Available at [https://www.researchgate.net/publication/267856221\\_survey\\_comparison\\_and\\_evaluation\\_studies\\_of\\_learning\\_content\\_management\\_systems](https://www.researchgate.net/publication/267856221_survey_comparison_and_evaluation_studies_of_learning_content_management_systems)
- [5] Buijserd, K. (2009). Demand-based learning in higher education from an organizational perspective. An assignment at KPMG, Information Technology & Management, University of Twente. p.12, 33-34.
- [6] Sinani, A. (2012). Computer in Educational process. ISBN 978-9989-788-61-1, Tetova: Luma Grafik, p.133-135).
- [7] Zamfir, A. (2008). *Impact of Using Computer Applications in Education on Teaching-Learning Process*, 7th WSEAS Int. Conf. on Applied Computer & Applied Computational Science (ACACOS '08), Hangzhou, China, p. 684. ISSN: 1790-5117.
- [8] UKIM: University Ss. Cyril and Methodius (2011) System for electronic students' services. Available at <https://finki.iknow.ukim.edu.mk/Account/Login.aspx?ReturnUrl=%2f> [Accessed 06/04/2015].
- [9] UGD: University Goce Delcev (2009). E-learning Center. Available at <http://elc.ugd.edu.mk/> [Accessed 05/04/2015].
- [10] Reskavska, T. and Shumadieva I. (2011). E-learning situation in Macedonia. Skopje: Metamorphosis, pp. 22-23.
- [11] SEEU: South East European University (2008 – 2013). E-learning Centre. *Learning Management System – LIBRI*. Available at <http://www.seeu.edu.mk/en/centres/e-learning> [Accessed 05/04/2015].
- [12] [12]. FON University (2003). E-learning system. Available at <http://learning.fon.edu.mk/m3/> [Accessed 05/04/2015].

# An Engineering Approach to Develop a Mathematical Model for Sustainable Population

Nukhet Sazak<sup>1</sup>, Haldun Abdullah<sup>2</sup>

---

## Abstract

*Sustainability has been linked with every aspect of present day civilization except size of human population. We talk about sustainable environment, sustainable economy, sustainable education, etc. and end up listing "... and also human population" at the end of the causes of environmental degradation, bad economy, inadequate education etc. Practically, the study of natural ecosystems alone is not getting us anywhere. We have to discuss these aspects for each political ecosystem as defined by the geographical borders of states as recognized by the UN and consider the human population in each state and determine the sustainability of its size. Political states and their populations have been suffering from the consequences of overpopulation for a long time. Indications of their continuously degrading environment, poor economy and unemployment are undeniable. On the other hand the size and distribution of the population of each state is well documented. Our primitive population model is considering the population distribution diagrams as a basic block with the net births each year as input to this block and the number of people that retire each year as the output. The difference between these numbers for each state will be the number of people that are expected to be unemployed when they reach the age 21 or 22 for university graduates plus the age group (15-24) that has not gone to university. We make a case study for some states and compare their present day unemployment. We open the development of unemployment mathematical model to other interested researchers for further development and collaboration.*

**Keywords:** Sustainable population, engineering model, demographic distribution, unemployment

---

## 1. INTRODUCTION

Sustainability has been linked with every aspect of present day civilization except size of human population and the human population density which can be measured as average population/km<sup>2</sup> for each country. We talk about sustainable environment, sustainable economy, sustainable education, etc. but never sustainable population. Is this intentional or merely a coincidence is not very clear.

Countries are ecosystems or parts of a larger natural ecosystem, surrounded by their political boundaries. Their populations are (or should be) responsible for the safety of their part of the natural ecosystem. It is clear however, that global warming and pollution, which seem to be here to stay for a long time, are resulting due to lack of responsibility of world countries (their populations)! It is obvious that if world population was one billion instead of 7.3 billion, no country would dare to burn so much fossil fuel since doing that would not be profitable! Also, we would not be facing such a big unemployment problem for so long. It seems that unemployment especially among the young is also here to stay. It also seems that global warming and the degradation of the environment is also here to stay [1].

Looking at the latest available data on youth unemployment [1] we see that unemployment rates for the European area countries is about 23% and that of France is nearly 25%, well above the present general unemployment rate of the respective countries which is about 10% [2]. Also way above the acceptable rates for countries which have "free" economies, which is about 5% [3]. These countries are considered "developed" countries, and the birth rates in most of them are below 1%. However, the average population density of most of these countries is above 100 person/km<sup>2</sup>, (usually assumed as a norm in sustainability quantitative analysis purposes). Examples, France 122, Hungary 109, Italy 207, Portugal 113, etc. These countries are overpopulated and their birth rate is not an issue at present [4].

We shall try to open the way to quantitative analysis to be able to say about resilience what other workers in the area of sustainability have already discussed and predicted qualitatively [5],[6].

In this work we shall use an engineering approach to determine the number of relevant extra births for a country that would contribute to the young unemployment of that country. We assume that the country of concern has no migration (to or from) for that particular year.

---

<sup>1</sup>Corresponding author: Sakarya University, Department of Electric-Electronics Engineering, Sakarya, Turkey. [nsazak@sakarya.edu.tr](mailto:nsazak@sakarya.edu.tr)

<sup>2</sup>Retired, Sakarya University, Department of Electric-Electronics Engineering, Sakarya, Turkey [halduna@gmail.com](mailto:halduna@gmail.com)

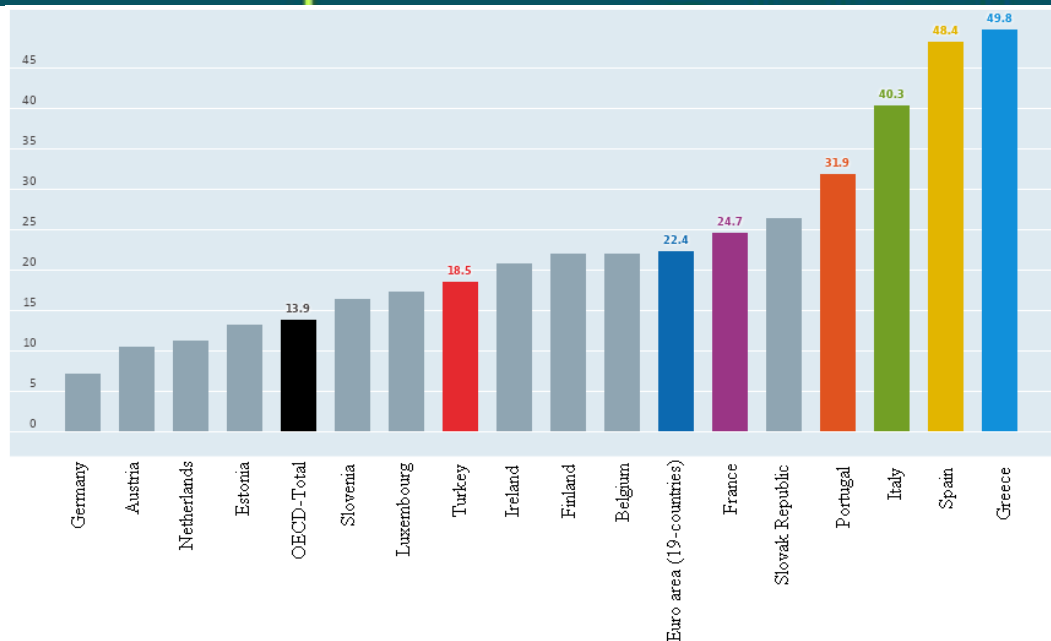

Figure 21. Youth unemployment rate, % of labour force, 2015 [1]

## 2.SUSTAINABLE POPULATION

We shall explain our engineering approach by illustrating the steps to be taken for the calculation of extra yearly births that contribute to young unemployment. We shall consider in particular European area countries that have low birth rates but have exceeded the assumed carrying capacity of their ecosystems(100/km<sup>2</sup> or there about). These countries are, France, Hungary, Spain, Italy and Turkey. The details will be worked out according to available demographic data. When exact data is not available we shall make reasonable assumptions (such as averaging some figures etc.).

Consider the demographic distribution of a particular country for a particular year. Taking the number of young people who are 15 that year to be (15-24)/10 as input to the work force and the number of population reaching the age of 65 as output from the work force, we see the following three possibilities (we assume equal yearly births and survival numbers (advanced stable population):

- 1) If population @ 15 = population @ 65 in number there will be no contribution from the 15 year olds to young unemployment.
- 2) If population @ 15 > population @ 65 there will be contribution to young unemployment, which also means that more births took place 15 years ago.
- 3) If population @ 15 < population @ 65 then fewer births have taken place 15 years ago.

This also means that there is more money available for the young employed (resulting from larger number of retired people), hence positive contribution to economic growth.

It is obvious that comparing the numbers of jobs being made available to the age 15 group to jobs becoming available due to retirement of age 65 does not mean that a job vacancy of a 65 year old will be given to a 15 year old. What this implies is that the budget resulting from 65 year old retirement shall be used to create appropriate jobs for the 15 year old.

## 3.THE PROPOSED MATHEMATICAL MODEL

From the information we gather from yearly published data on population demographics we can generate Table 1, with the following columns:

- a) The first column we list % of young (15-24) unemployment a particular year, say the year 2015.
- b) Knowing the population distribution for the year 2015, we determine the total number of young population (15-24) as listed in column (b).
- c) From (b) we find the number of unemployed young by multiplying (a)&(b).
- d) Consider the number of births @ year 2000 to determine population overshoot contribution.
- e) Assuming no input from migration, subtract one tenth the number of (c) from (d) to find the population overshoot due to too many births.

NOTE: This calculation can be made more accurate detailing yearly demographic, but it is not necessary for our purposes in this work.

The calculations above have been made for the European area, France and Turkey as shown in Table 1 below.

Table 7. year 2000 Population overshoot for some countries

Country	(a)%	(b)(15-24)Persons	(c)(15-24)Unemployed	(d)2000 Births	(e)Overshoot
France	24.68	11,640,263	2,872,817	774,782	487,500
Hungary	17.30	1,669,624	288,845	98,000	69,116
Spain	48.35	6,449,045	3,118,113	397,632	85,821
Italy	40.33	8,372,141	3,376,484	543,039	205,391
Turkey	18.52	20,701,736	3,833,962	1,389,000	1,005,604

## 4. CONCLUSIONS

From the table it is clear that economic crisis resulting from high unemployment follows from high birth rates. Now it could be argued that birth rates cannot be controlled because of human rights. But human responsibility is also a virtue which is granted for humans only. So why not remind the human race of this virtue.

It is clear that the political ecosystems occupied by countries presently indicate that their carrying capacity is exhausted. An international call should be made to all countries to assume responsibility.

We should remember that throughout history humans have come together to form families, groups, clans, nations which are extinct today. It is obvious from historical findings that the previous human societies were not resilient. If we can predict that a flat tire in a highway can deter our journey (thus we carry a spare tire) we should also be able to predict that if we do not save enough natural resources in our ecosystems then we cannot continue the journey of civilization. It will be interrupted for sure and the human offspring will have to start all over again!

Finally, we see that a simple input – output model can help to have a bird's eye view of population progress in a human society and helps to predict what actions need to be taken for longevity of our ecosystem.

## BIOGRAPHY

Nukhet Sazak ([nsazak@sakarya.edu.tr](mailto:nsazak@sakarya.edu.tr)) has been an assistant professor in Electrical and Electronics Engineering at the Sakarya University since 2012. She received MSc and PhD degrees from the department of Electrical and Electronics Engineering at Sakarya University in 2002 and 2011, respectively. Her current research interests include MAC protocols, wireless sensor networks, engineering education, and environmental issues.

## REFERENCES

- [1] OECD Data website. Available: <https://data.oecd.org/unemp/youth-unemployment-rate.htm#indicator-chart>
- [2] OECD Statistics website. Available: [http://stats.oecd.org/Index.aspx?DatasetCode=POP\\_FIVE\\_HIST#](http://stats.oecd.org/Index.aspx?DatasetCode=POP_FIVE_HIST#)
- [3] Federal Reserve Bank of San Francisco Economic Letter, February 14, 2011. Available: <http://www.frbsf.org/economic-research/publications/economic-letter/2011/february/new-normal-%20unemployment-rate/>
- [4] Worldbank Data website. Available: <http://data.worldbank.org/indicator/EN.POP.DNST>
- [5] K. A. McKee and L. M. Kohm, "Examining the Associations between Sustainable Development Population Policies and Human Trafficking", 23 Michigan State International Law Review 1 (2015), January 17, 2015. Available at SSRN: <http://ssrn.com/abstract=2551305>
- [6] Dr. A. A. Bartlett, "Reflections on Sustainability, Population Growth, and the Environment", An NPG Forum Paper, February 2016.

# Environmental Pollution Of Coastal Waters During Vlora-Saranda And Evaluation Of Level Of Pollution

Dafina Nazaj<sup>1</sup>, Simo Ribaj<sup>2</sup>

---

## Abstract

*The presence of organic pollutants in the environment is a problem that has caused a great public concern and has attracted the attention of researchers. Continuous emissions of these compounds have led to increased concentrations in water. These toxic compounds that cause water pollution and eutrophication of their ongoing constitute great danger not only for the natural flora and fauna of groundwater, but also for all crops, livestock and the man himself. The impact of the presence of toxic substances in the marine environment is quite powerful to compromise the physiological and health values. In particular pesticide contamination of the surface and underground water that comes from their use in agriculture is a wide world problem.*

*Studies and environmental monitoring, identification of pollutants in the environment as a result of various economic activities, continuous information about environmental conditions are particularly important to identify the problem and measures for environmental protection and rehabilitation.*

*In this article we have handled different definition of organic toxic compounds through the application of modern analytical methods. Determination of pesticides, polyaromatic (PAH), benzene and its counterparts (BTEX), hydrocarbons, etc. in waters, have a particular importance. They are classified as priority because being cancerous are very dangerous to health.*

*The content of toxic organic compounds depends on many factors, such as: season, climate, infrastructure changes, which requires a systematic monitoring. On the other hand, during crossing pesticides in marine organisms, fish, eel, shrimp, etc., they concentrate on these organisms and can be assessed more easily with analytical methods because of the highest concentration. Therefore, analyzing the content of these compounds in these organizations better meet the situation of the environmental pollution.*

*For the above categories was defined compounds used modern techniques of extraction new convenient and practical to spend very little solvent and time and cost effective way of gaseous phase chromatography in kapillary columns with ECD and FID detectors. Therefore, water samples were taken Vlora- Saranda along the coast, which is an environment surrounded by sea and lagoons and numerous channels that traverse the area, mainly in some areas most affected by human activity, such as Narta Lagoon, Orikum, Vlora Bay, etc. PAH have not been identified, but identified some pesticides such as lindane and its isomers, DDT and its metabolites and HCB in very small quantities.*

**Key words:** *environment, pollution, SPE, SPME, pesticides, aromatic, BTEX.*

---

## Consequences that bring organic pollutants in environment

The presence of organic pollutants in the environment is a problem that has caused a great public concern and has attracted the attention of researchers. Continuous emissions of these compounds have led to increased concentrations in water. The impact of the presence of toxic substances in the marine environment is quite powerful in physiological values and compromised health

In particular pesticide contamination of surface and underground water that comes from their use in agriculture is a wide world problem. In special way:

### Pesticides:

The use of pesticides in agriculture bring pollution of surface and groundwater and has led to their presence in different environments. Their content in different samples is in small concentrations and in the presence of interference of a large number of compounds. Considering the extent of use, their number may reach 42 or more. But according to the Environmental Protection Agency (EPA) are designated as priority 16 pesticides.

### Polycyclic aromatic hydrocarbons (PAH):

They are the components more pollutants into the environment, because of their activity mutagenik cancerous and come in different environments from natural sources (combustion incomplete at high temperatures and pyrolytic processes of fossil fuel turba, coal and oil) or anthropogenic (emissions into the environment due to emissions of cars, etc.

---

<sup>1</sup> "Reald" Universiteti of Vlora, Albania

<sup>2</sup> Director of SEEP( Society of Education and Enviromental Protection) of Vlora, Albania

## Benzene and its counterparts:

Gasoline and diesel that runs on water and soil deposits of underground leaks or discharges of oil and water accompanying oil, poses an environmental concern. The assessment of the pollution based on the determination of benzene and its counterparts (BTEX).

## Modern methods of fast classification

1. **Classic methods:** as the standard methods require large amounts of sample, long sample preparation prior to final concentration and large amounts of organic solvents. For this reason, in recent years attempts have been made to simplify the preparation of the sample by reducing its volume, which leads to reduction of analysis time and the amount of organic solvents used [4,12].

2. **Extraction in solid phase SPE (Solid Phase Extraction)** constitutes an important step, as a quick method and uses small amounts of organic solvents. *The first step* in SPE method is observation of the organic compounds and *the second step* are analyses of these compounds in accordance with the physical and chemical properties of the compounds of interest [8,9,12]. (Figure 1).

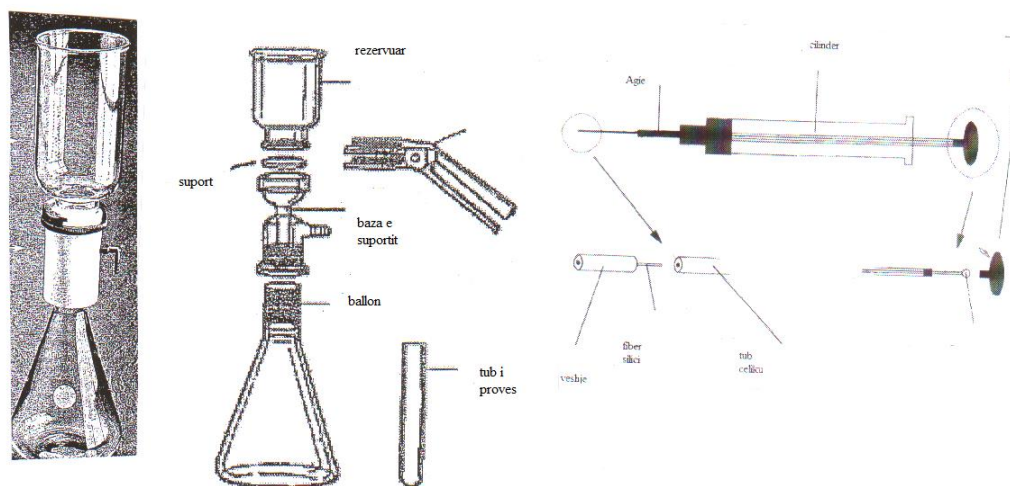

Figure 1. Schematic of household solid phase extraction on SPE and SPME

3. **Micro extraction in solid phase SPME (Solid Phase Microextraction)** is a new technique even more advanced sample preparation, very useful in analytical chemistry, which eliminates the use of organic solvents, simple and that integrates ordering to a single order, extraction and analysis of the extract (gas chromatographic method). [1,2,12]. Desorption of organic compounds made in Gas chromatographic injector in temperature from 250°C to 3000°C.

## Extraction and determination of pesticides:

Methods of determining the pesticide [12.15] involves taking the sample, extraction of pesticides by SPE or SPME and analysis of individual pesticide composition priority by Chromatography in the gaseous phase detectors ECD (Electron Capture Detector). For pesticide use EMPORE DISK SBD - RPS with diameter 47 mm, which is activated by throwing twice from 5 ml acetone and drain under 100 mbar vacuum. Then added 10 ml of ethyl acetate, 10 ml of ethanol and 10 ml of distilled water [5,9]. Microextraction in solid phase (SPME) fibers utilize wearing polydimethylsiloxane (PDMS) 100 μm. SPME parameters are optimized for extraction good win for all groups of pesticide, herbicide, insecticide, fungicide. The water sample is put in these terms: tablespoon of salt 15% and methanol < 0.1%, vibration speed 960 rotations / min; pH = 7; Balancing time: 45 min; Water temperature: room temperature (25 ± 2); Desorption time in nozzle 10 min [4.12]. The Gas chromatographic method contain individual composition of 16 priority pesticides (figure 2).

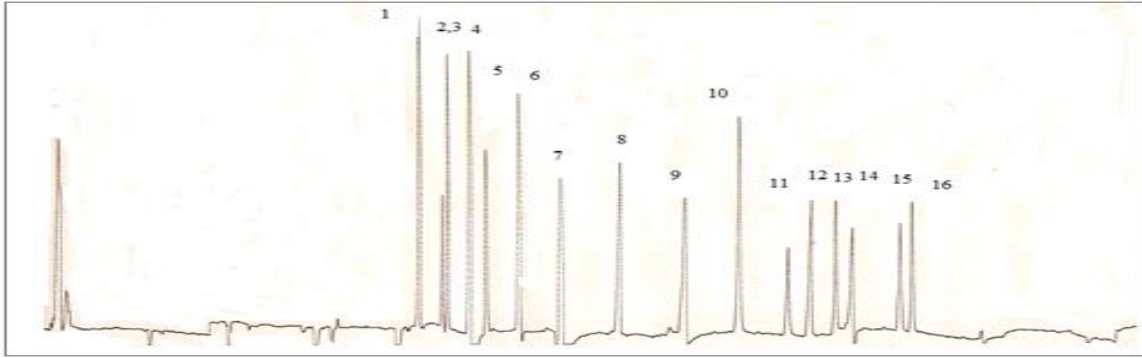

Fig.2. Individual composition of 16 pesticides priority: 1.  $\alpha$ -BHC; 2.  $\beta$ -BH; 3.  $\gamma$ -BHC (lindane); 4.  $\delta$ -BH; 5.heptaklor; 6. Aldrin; 7.heptaklorepoxyde; 8. endosulfan; 9.DDE;

### Extraction and determination of polyaromatic hydrocarbons (PAH)

Methods of determining the polyaromatic hydrocarbons (PAH) includes [12.16] side of the extraction system using a standard SPE disc C- 18 DISC which is activated by throwing twice from 5 ml acetone and drain under 100 mbar vacuum. Then added 10 ml of ethyl acetate, 10 ml of ethanol and 10 ml of distilled water. Extraction of the sample from the water, jump 500 ml water and put camera under 200 mbar vacuum. Absorbed compounds extracted from disk adding 5 ml three times ethyl acetate under 200 mbar vacuum. The concentration of nitrogen stream test done at [9.12] up to 100 $\mu$ l ethyl acetate and injected into Gaschromatograph 1,5 $\mu$ l in gas stage of capillary columns and FID detector. Gaschromatography contains individual compositions 13PAH priority (Figure 3).

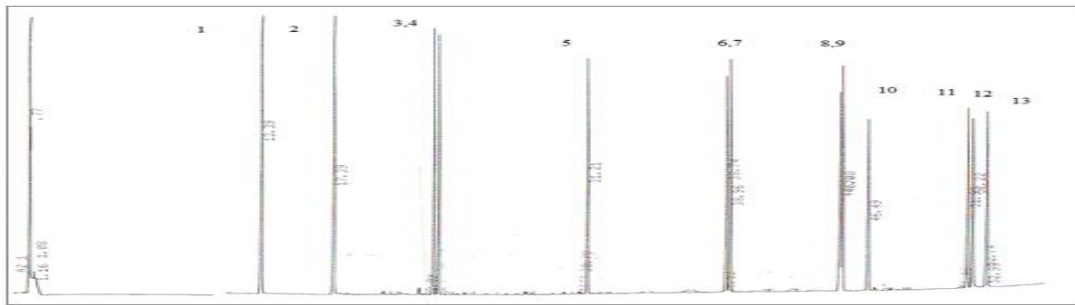

Fig. 3. The composition of the 13 individual PAH priority: 1. Acenaftalen, 2. Fluoren 3. Fenantren. 4. Anthracen, 5. Pyren, 6. Benzo [a] anthracen, 7. Crisen, 8. Benzo (b) fluoranten, 9. Benzo [k] fluoranten, 10. Benzo [a] pyren, 11. Indenol [1,2 3 - cd] pyren, 12. Dibenzo [a, h] anthracen, 13. Dibenzo [a, h] anthracen.

### Extraction and determination of BTEX.

Analytical work involves the extraction of BTEX by SPME and the hydrocarbon composition analysis by Gaschromatography stage. SPME fiber is coated with PDMS 100  $\mu$ m (polidimetilsiloxane). In a 40 ml bottle jump 25 ml water and the piece of magnet. Put the bottle in a magnetic mixer and affixed with a clip. Promoted magnetic mixer 1200 spins/ min. We prick the lid with a needle of the SPME device and embedded device with a latching. Fiber exposed by pressing the plunger in the end position by turning it clockwise. Fiber should be located in the space above the sample (HS). Date Timer and timed extraction of 2 min. The needle withdrawn and terminated fiber within SPME device of the bottle. We put the bottle of SPME in the gas-chromatographic injector. Departs analysis by pressing the plunger and placing it in the last position (low). After 30 sec withdraw the fiber within the needle and leave the needle from the

nozzle. The division by gas-chromatographic analysis is [1,7,12] (Figure 4).

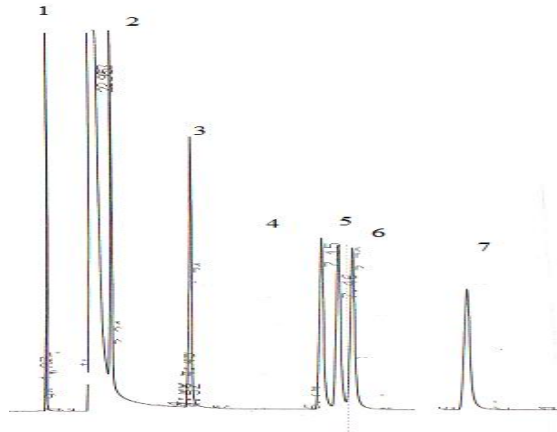

Figure 4. Gaschromatography of a standard mixture of benzene, MTBE and his counterparts, performed by Wax capillary column 10, used mainly to share isomers p-, m- and o xylenes : 1.MTBE, 2. Benzene, 3. toluene, 4.Etil benzene, 5. p-xylenes, 6.m-xylenes, 7. o-xylenes.

The above methodologies have been applied to determine the content of pesticides and PAH-s in water samples taken in the area of Vlora, in the sea and lagoons.

### A description of the area of study.

In the study area includes the Narta Lagoon, Orikumi Lagoon and the Bay of Vlora,

**Narta Lagoon** (Figure 5), one of the largest and more lagoons key of Albania, with an area of 45 km<sup>2</sup> and depths from 0.3 to 1 meter, connected to the sea through two artificial channels, Big Dajlani at north and Small Dajlani at south, which themselves have realized the process of communication of waters between the sea during tidal and intertidal. The most important potential source of chemical pollution for the Narta Lagoon are discharges of Vlora residents and surrounding villages and Soda-PVC plant in Vlora, during operation. Construction waste is a potential source of pollution of the lagoon. Discharge of sewage, storage of solid urban waste of Vlora city and solid waste from residents residing in the vicinity, ways of fishing, uncontrolled urbanization territories around the lagoon, etc form an environmental pollutant factor of it [13].

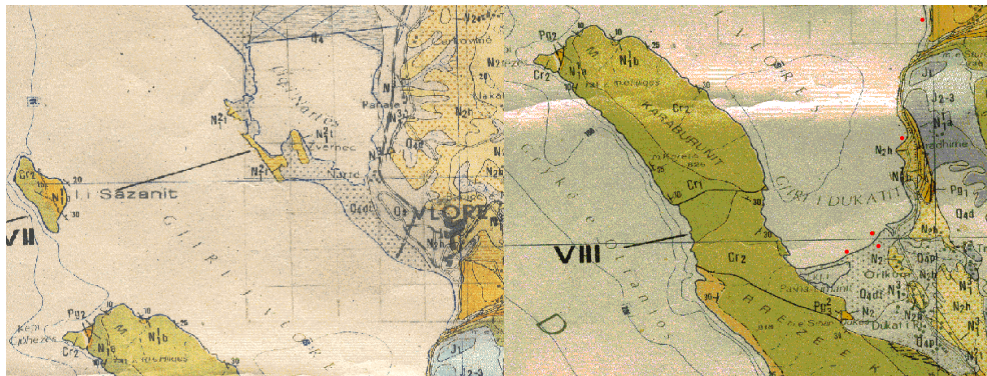

Figure 5. Narta and Orikumi lagoons.

**Orikum Lagoon** (Figure 5), in the southern part of the Bay of Vlora with approximately 150 ha of water surface and a maximum depth of 3 meters, connected with the sea by two channels, of which one is open artificially, in the eastern part of the lagoon almost adjacent to Pashaliman military base checkpoint. The most important potential source of contamination for Orikum Lagoon constitutes Pashaliman naval base, which lies in the direct vicinity of its west coast.

**Bay of Vlora**, lies in the south of Albania, who represents the natural border between the Adriatic Sea. Flow of water in the Bay is often limited and shipping activities increase the level of pollutants, such as: oils, trace metals, nutrients and organometallic compounds, urban discharges, sewage and construction waste downloads and constructions without criteria [12].

### Sampling

For Narta Lagoon they were selected 6 sampling stations, while Orikumi Lagoon 5 sampling stations were selected. Sampling stations were chosen in such a way as to make a better assessment of the overall situation of the lagoons and assess potential sources of pollution. For each lagoon set a reference station in the sea, in an area close to the direct communication channels with the sea lagoons. Naval stations were considered as reference stations for assessing the degree of pollution of the lagoon environments (compared to the respective marine environments).



## Water quality assessment

The assessment of the water quality by determining the content of toxic organic compounds by the methods described above was conducted within the setting of the whole complex of indicators of pollution. The measurements performed directly in the studious zone by portable equipment: measurement of pH and temperature performed by pH meter: nutrients measurement, ammonium, nitrate, nitrite, phosphate, chlorine with the field photometers side C 209 Multi Parameter Iron Specific Meter and Spectro 2. For an assessment of sufficient quality more full of waters and environmental problems were taken samples in selected points and was conducted on laboratory analysis of N-NO<sub>3</sub>- nitrates, nitrites N- NO<sub>2</sub>-, ammonium N-NH<sub>4</sub> +, phosphates, pH and redox potential E (mV), the case of the solid in suspension (TSS), dissolved oxygen DO, the biological need of oxygen BOD, bacteriological load [12,17]: Coliforms, Fecal coliforms (FC), Enterococcus intestinalis( Fecal streptococcus-FS), etc, definition of the water colour [12,18] with turbidimeter and Secchi disk [12,18 ], contains a- chlorophyll [12,18] For determining the content in the organicchlorine pesticides and PAHs in the waters of the Bay of Vlora, samples were taken near the sites of discharge of channels, which bring organic compounds. On the side of Gaschromatography with ECD detector we see the diverse pesticides in waters in the region of Vlora, [12.15]. The highest contentment was especially in discharges of water channels in Narta and Panaja(at Salt), specially heptachlor and heptachlor epoxide. Smaller amounts were identified  $\alpha$ -BHC and even smaller amounts 4,4'-DDD. In other champions like Orikum Lagoon, Vlora Bay (Sazan-Karaburun - Triport, Karaburun (Fish reserve ), Dhermi - Himare areas, Seman river presence of the foregoing compounds was found at footprint priceless quantitatively levels. In general, in samples studied were observed regularly greater amount lindane and isomers of DDT and its metabolites and HCB. The average level of total organic - chlorine pesticides in the studied samples were respectively 18.9 ng / g, 12.0 ng / g, 15.1 ng / g and 7.1 ng / g. The maximum level for the sample was for the kind called *saragua* get in Vlora Bay with 31.2 ng / g. Lower levels of pollution were in the wild shrimp samples with 1.62 ng / g. Heptaclor and lindane are found in almost all samples taken in the analysis. The above samples were analyzed for the determination of PAH [12]. With Gas-chromatographic with capillary columns and FID detector didn't find PAH quantities.

## In conclusion

We can say that modern methods of extraction (SPE and SPME) and determining of their individual compositions by chromatography in the gas phase was successfully implemented and applied for the assessment of environmental pollution of waters in the region Vlora. Environmental studies will be more complete and safe if toxic organic compounds in marine organisms determined this after the sensitivity of analytical methods is greater. The high contentment of pesticides was found especially in discharge wastewater channels and salt water in Narta, Panaja, specially heptachlor and heptachlor epoxide. Smaller amounts were identified  $\alpha$ -BHC and even smaller amounts 4,4'-DDD. In other samples as Laguna Orikum, Vlora Bay (Sazan-Karaburun - Triport, Karaburun (the fisheries stocks), area Dhermi-Himara and Seman river the presence of the above compounds found in trace levels priceless quantifiable. On the side of Gaschromatographic with capillary columns and FID detect didn't define large quantities of PAH. However, Gaschromatographic profiles can be used as a "fingerprint" to compared the type of the dissolved organic pollutants into the water. For the determination of PAH is more suitable be used HPLC and GC- MS; also for a safe definition has more toxic organic compounds be used GC-MS. Determination of the scope of other compounds such as phenols, fatty acids, as well as making use of BTEX extraction SPME in the solid stage.

## REFERENCES:

- [1] Jansz Pawlyszyn. "Solid phase microextraction". Theory and practice. WILEY – VCH. 1997.
- [2] Jansz Pawlyszyn, Barbara Pawlyszyn, Michall Pawlyszyn."Solid phase microextraction". The chemical educats .Vol.2. Nr.4. 1997.
- [3] Joannis K. Konstantinon, Dimitra G. Hella, Triantafyllos Albanis. "The status of pesticide pollution in surface waters (rivers and lakes) of Greece". Part I. "Review of occurrence and levels. Environmental Pollution ". XX (2005) . 1-16.
- [4] Dimitra Llambropoulou, Vasilikas A. Sakkas, Dimitra G. Hela, Triantafyllos Albanis. "Application of of solid - phase microextraction in the monitoring of priority pesticides in the Kalamas river (N.W Greece)". Journal of chromatography A, 963 (2002) 107 – 116.
- [5] T.A.Albanis, D.G. Hela."Monitoring of pesticide residues and their metabolites in surface and underground watersof Imatha (N. Greece) by means of solid phase extraction disk and gaschromatography".Journal of chromatography A. 823 (1998), 59-71.
- [6] Stephan. J. Crook, "The application of solid phase microextraction to pesticide residue analysis". The Royal Societyof Chemistry.Chromatography. Monograph. Rogar M. Smith series editor. 1999.
- [7] Ingrida Seduikiene, Vida Vickockaste, Rolands Kazlaukas. "Solid phase microextraction of volatile aromatic hydrocarbons from soils".
- [8] W. Kanchanamayoon and N. Tatrakin. "Determination of polyaromatic hydrocarbons by solid phase extraction and gaschromatography" World Journal Chemistry 3(2) 51-54 . 2008.
- [9] R.M. Mare, F. Borruel. "Solid phase extraction of polycyclic aromatic compounds". Journal of chromatography A, 885 (2000) , 273-290.
- [10] J. Beltrau, F.I. F. Hernandez."Solid phase microextraction in pesticide residue analysis". Journal of chromatography A, 885 (2000) 389- 404.
- [11] Hirouiki Kataoka, Heather L.Lord, Jansz Powlunszin. "Application of solid phase microextraction in food analysis". Journal of Chromatography a 880 (2000) , 35-62.
- [12] Shkurtaj. B., Kotori. P., Çullaj.A., Albanis. T.,Shehu. M., Kalluci. V.,Hasani. L.Hasanaj. V., Çako.V., Muço. M., Kane. S., Kicaj. E.:"Development and application of analytical methods of assessment of environmental pollution from toxic substances in surface, groundwater and drinking water in Vlora region". Project under the National Programme for Research and Development(NPRD). Biodiversity and Environment. Vlora 2010-2014.

- [13] *Narta Lagoon natural wealth at risk*". Works referred to in the national workshop, Tirana, 29 April 1999.
- [14] APHA/AWWA/WPCF. (1995): "*Standard Methods for the Examination of Water and Water waste*". 19th Edition, American Public Health Association.
- [15] Nuro. A., Marku. E., Shkurtaj. B., Shehu. M., Mucollari. N., "*Study of chlorinated organic pollutant levels with technical means GC / ECD samples of water waste in the sea*". I.Qemali, Scientific University. No.1., volumi .2-2013.
- [16] N. P. Petridis, V. A. Sakas, T. A. Albanis. "*Determination of priority PAH in Water samples based on SPE and gaschromatography coupled to mass spectrometry*".
- [17] Hasanaj. V., Kicaj. E., Cercizi. R., Xhuveli. A." "*Microbiological study of water environment in the region of Vlora,*". I.Qemali, Scientific University. No.1., volumi .2-2013.
- [18] Çako. V., Zhuri. E., Babani. F., Shena. M. "*Characterization of turbidity of waters of Burtinti Lake and Saranda Coast*". I.Qemali, Scientific University. No.1., volumi. 2-2013.

# Sustainability in Hospitality Industry in Turkey: National and International Applications

Huseyin Cetin<sup>1</sup>, Zekeriya Yetis<sup>2</sup>

---

## Abstract

Worry about having limited sources brings "the conception of sustainability" into agenda. Sustainability and concordantly; sustainable development (sustainable improving) composes the basis of "the conception of sustainable tourism". Sustainable tourism derived from worries related to impacts came light from the tourism that originated from environment. In recent years, as it happens in other industries. For tourism industry and specifically accommodation facilities, the conception of sustainability gains importance gradually. In this context, accommodation facilities with application called certificate programs having particular standards, national and international awareness, eco-label try to provide sustainability in Tourism Industry. The purpose of study is to examine and evaluate the applications using optionally in Turkish accommodation facilities internationally Blue Star, Green Key and national Green Star, White Star and Greening Hotels. In this direction, conceptual framework has been comprised into study. Raising the attention, by years, to those applications at accommodation facilities in Turkey is one of the important result of study and shows the importance that accommodation facilities give for sustainable tourism.

**Keywords:** Sustainable Tourism, Certificate Programs, Eco-labels, Awards.

---

## 1. INTRODUCTION

Improvements about sustainable development in the world and for other industries has started to show its impact. In this point, environment which affects the tourist's preference and make them active, playing a great appealing role and its relation with tourism have gained importance ([1], [2]). Environment for tourism industry is the essence of tourism operations and activity ([3]). That is a vital factor to be able to continue its existence and survive its activities its and improvement ([4], [5]). The most important effects of tourism happen on environment ([6]). Tourism which is an economic activity brings about some positive and negative environmental effects on the place where it has happened and improved ([7]). The survival of tourism activities and continuity of touristic demand depending to it can be possible by lasting the quality of environment ([1], [2]). Tourism case will no carry on its existence owing to the fact that a tourism that damages nature and environment will erase its source which are involved in tourism ([8]).

In parallel with industrial improvements and sustainable development concept, the concept of sustainable tourism has appeared. Accommodation businesses as the other businesses have been effected by those changes ([9]). Being tourism activities improvements depended upon mass tourism, founding the tourism marketing about tourism development on consumption policy ([10], [11]), spending the funds without plan for short-terms benefits instead of long-term investments ([12]) cause natural resources demolishment and destruction and losing its attraction ([6], [9]). Negative affects which tourism bring about on environment directed the accommodation facilities to produce sustainable practices in order to decrease the damage minimum level on environment and to gain much more benefit from tourism ([13]). In this direction, accommodation businesses have started use practices aiming sustainability in tourism, reward, eco-label or certificate programs. These practices basically focus on the cases of water and electric usage, management of waste (decreasing, recycling and reuse) and protection of air quality ([14], [15], [11]).

Accommodation businesses making practice for tourism could be described as reducing the cost so that they may gain much more profit and increasing the productivity, the producing the new goods and services that demanded by tourist, the obtain positive image by citizen and competition advantage ([16], [17]), changing the demands and expectations of tourists, the falling mass tourism demands and increasing the appeal through other tourism types are the essential suppliers to determine tourist travel reasons on cultural, historical and natural ways ([10]). Additionally, some legal obligations ([18]), being agenda of environmental problems and environment conception gains meaning constantly and raising the concern to environment, attempts and effects of national and international agreements, composing the consciousness of environment for tourists, raising the awareness to protect the environment by tourists and raising sensibility are influential as well ([8]). In addition, reward, eco-label and certificate programs which get increasingly common, accelerate the hospitality businesses to come into an environment friendly approach. In this context, the new hotels will be opened in the future will be named mostly as environment friendly hotel, green hotel, eco-hotel ([8]). Within the scope of sustainable tourism, in Turkey, in accommodation operations still perform Blue Flag, Green Key, Green Star, White Star, Greening Hotels practices. These practices composes the theme of study.

---

<sup>1</sup>Necmettin Erbakan University, Faculty of Tourism, Karatay/Konya, Turkey. [hcetin@konya.edu.tr](mailto:hcetin@konya.edu.tr)

<sup>2</sup>Corresponding author: Necmettin Erbakan University, Faculty of Tourism, Karatay/Konya, Turkey. [zyetis@konya.edu.tr](mailto:zyetis@konya.edu.tr)

## 2.SUSTAINABLE TOURISM / SUSTAINABILITY IN TOURISM

Sustainable tourism came out from worries relating the impact tourism caused ([19]). In 1970s the discussions about saving the environment had also been in tourism industry and by taking into consideration of potential dangers of industry, it was pointed out there has to be an approach sensible to environment. Correspondingly, sustainable tourism concept has come to light ([20], [21]). As an industry that stills keep on advancing itself, in order to provide its sustainability, too many global study has been carried out ([22], [21]). According to World Tourism Organization, sustainable tourism is to improve the opportunities and protect while you are meeting the needs of home owner regions and tourists today ([23]). Sustainable tourism, by obeying the sustainable development principals, is a tourism improvement that tourists' needs met and accept guest ([22]). In this and similar descriptions, sustainable tourism aim to be used with the future generations when cultural and natural resources usage continue. To have limited resources makes it prior the mind of protection and using balance and presents us an alternative for being sustainable of resources ([24]).

In evaluating the sustainable tourism and measuring the impacts, there have been three factors that accepted. These are environmental, social cultural and economic factors ([25]). Sustainable tourism bases on the improvement of tourism from its environmental, economic and social cultural ways. When it is considered that environment is a tourism resource for tourism industry, it can be said that economic and social sustainability depends on environmental sustainability. Sustainable tourism is accepted as a balance factor in the cases of economic improvement, protection of environmental resources and local citizen and tourist's satisfaction ([26]). A sustainable tourism only could be sustain with environment and ecology, could be performed with economy, and acceptable with socialize and could be done environmental management and planning depending upon acceptable options ([27], [19]). Accommodation businesses carry some liabilities in order to gain a sustainable improvement in Tourism as other tourism operations. Accommodation businesses have to be involved in activities by taking into considerations to meet the needs of people and during doing this, they have to be respectful on people's value and beliefs and social norms and also accommodation businesses have to contribute to society's economic and social prosperity and life quality ([28]). Accommodation businesses have to handle not only in economical meaning but also social and environmental meaning together. In this connection, eco-labels, certificates and rewards among practices which will be effective the description of sustainable development will go in for ([14]). In the world, as it happens for other industries, the application also used in tourism industry has attracted the notice with those practices (reward, eco label, certificates) and those practices gain importance for accommodation businesses as well.

Generally eco-labels, within the scope of categorizing the special productions/service depending on the factors of life cycle and it describe the general principles of environmental preference. It reveals producers or explanatory information ([29]). According to the description of GEN, eco-label is briefly a method labeling and documenting environmental performance optionally ([30]). Eco-labels are rewarding by the third person and when it is searched, they are less harmful compared to other productions, and exhibited independently in order to reach the environmental criteria. It carries to purpose of increasing the sensitivity about environment and health of consumers and direct them to prefer non-harmful productions for environment ([29]). This is an effective means to provide sustainability in tourism with this option. Certification is the process by which third-party assessment is undertaken, written assurance is given that the product, process, service or management system conforms to the standard. Also describe certification as the procedure that audits and gives written assurance that a facility, product, process, service or management system meets specific standards. It awards a logo or seal to those that meet or exceed baseline criteria or standards that are prescribed by the program ([31]). Eco-labeling and certifications are systems practiced voluntarily. Eco label and certificate programs having different meanings and measurements and geographical scope ([32]) could describe as easy and legible of tourism productions environmental qualities multiple dimension and also test and summarize. This case brings about to be promoted and known the operations in environmentally sensible practices and gives especially information about tourism destinations to foreign tourists ([33], [34]).

## 3.SUSTAINABLE TOURISM PRACTICES IN HOSPITALITY INDUSTRY IN TURKEY

Accommodation businesses have started to be involved national and international projects in order to provide sustainability of tourism and decreasing the negative effects of tourism with having the mentality concept of sustainability in tourism. However the changes occurred in tourism acts that is to mean tourist become more aware of environment and prefer to accommodation businesses more sensible to environment. In this view, various countries carry out plans, policies and practices which will improve sustainable tourism within the scope of sustainable environment ([7]). In the world, there has been composed some standardization by national and international association with particular documents and rewards and carried out some certificate programs and tried to provoke sustainable facilities in accommodation operations and beaches with a kind of practices. In the 1990s and based on the ecological efficiency under different names, hotel, travel agency and tourism businesses different reward/the prevalence of applications that are executed in the form of a label or the certificate export has gained ([14], [5]). Numerous awards at national and international level in the world recognized eco-labeling and certification program. International and at the country level, Nordic Swan (Nordic countries), EU flower (European countries), the Green Failte (Irish) ([17]), Green Globe, Blue Flag, Green Key, as well as the tourism industry continues to be developed and improved to applications that have specific standards. The development of enterprises in the tourism and accommodation sector in the world and certificate programs, awards, eco-labels and standards as a result of the increase in Turkey, the Ministry of Culture and Tourism and tourism-related organizations, industry has developed various applications for environmental sustainability ([7]). Accommodation establishments in Turkey which constitute the environment and protection of the environment and sustainable tourism at the beaches of Blue Flag are within the scope of the provision, Green Key, Green Star, White Star and Greening Hotels developed application.

## Blue Flag

Blue Flag, applied required standards and optionally, carrying, demanding, given to qualified yachts plus beach and the marina, the cleanliness of the sea water and environmental management paid attention to that made for the creation of environmental awareness activities on the beach or the marina that guarantee the safety of users and hardware that will respond to the needs of an international environmental award ([35]). The Blue Flag project in 1985, in France, France swimming-water quality and the coastal resorts of environmental cleanliness based on granting the Blue Flag began in Europe and has started to be implemented in 1987. The European Union (EU), France determined the criteria of environmental management, pollution, war and coastal planning and protection, such as adding criteria ([36], [17]) in the EU countries with an objective that will be used for determining the microbiological parameters of water quality required for lakes and marine waters, guidance and mandatory provisions, as has revealed. This work in 1987, the European Environmental Education Foundation (FEEE) merged under the name of the campaign conducted by the Blue Flag, just before 11 European countries, then it has been applied with success in 22 countries. The European Environmental Education Foundation to Finland from outside the European Community adopted in 1991 for the first time ([36]); Europe located outside of the country for the first time in 2001, South Africa, Canada, Morocco and New Zealand the Blue Flag project has started to be implemented in the Caribbean. In line with this, the scope of the campaign expanded, the United Nations Environment Program and the World Trade Organization and has been a partner in the campaign FEEE the name of the Foundation for Environmental Education (FEE) was changed to ([17]). After Finland's accession in FEE, Turkey started preparations for the Blue Flag campaign. FEE, Blue Flag countries who want to carry out the project, non-governmental organizations to be represented by wants. Therefore, in 1993, under the leadership of the Ministry of Culture and Tourism of Turkey foundation for environmental education (TURKISH) and the Blue Flag project was established since 1993 in Turkey, TURKISH is carried out ([36]).

The project started to be implemented primarily at the beaches, after a while, the beach as well as a marina were also included in the project. Blue Flag beaches-related criteria, has been revised several times. 27 criterion set for the beaches was increased to 33 percent as of 2013. Although these regulations are increasingly tightened during the Blue Flag beach criteria, it is observed that a request to participate in the program increased. These criteria are a mandatory part of it a partial guide criteria. Determined criteria for their beaches; bathing water quality, environmental education and information, environmental management, safety and services there are 4 main groups. Beaches and marinas that meet this criteria for a period of 1 year is rewarded by being given the Blue Flag for beaches and marinas that has received this award season and are controlled. If a problem is found during this inspection, the Blue Flag will be lowered until the issue is resolved. FEE, Blue Flag beaches and marinas are announced and are published in the internet by all over the world ([36]). A Blue Flag beach with this information, the business brand awareness and it can be said that increases the demand for the tourist business.

Table 1. The number of blue flag hotels yearly

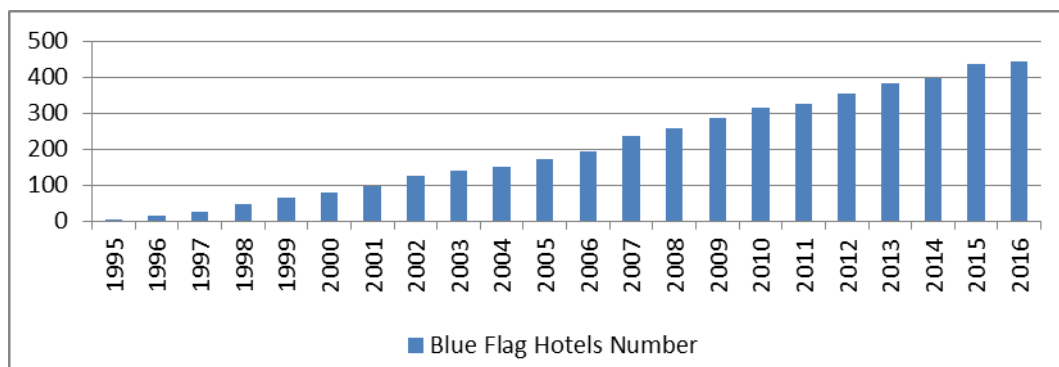

References: TÜRÇEV, 2016.

Blue Flag is an important application in terms of tourism and international nature is a powerful tool and router ([37]). In terms of providing a competitive advantage in the tourism sector for years, the number of countries applying the system has increased in the Blue Flag. The increase occurred in the number of Blue Flag facility at the international level, countries shows that the importance of this practice ([34]). Blue Flag project worldwide, including 30 countries in Europe, is being implemented in 50 countries ([35]). In 2016, as a result of the evaluation made by the FEE Turkey, which has 588 blue flag beaches with 444 beaches in 50 countries and is located on the beach 2 ranking after Spain. In addition, 21 marinas and 12 yachts have been awarded with the Blue Flag in Turkey ([36]). In 1987, among the European Union countries and in the international Blue Flag application to be implemented starting in 1991, although Turkey is the middle position where it has started to implement in 1993. In this case, Turkey can be considered as positive for the sustainability of tourism for tourism. Table 1 blue flag of the year in Turkey as it is seen an increase in the number of beaches. The efforts they put forth to ensure the sustainability of the tourism and hospitality businesses this can be considered as an indication of the importance they attach. Among the reasons for this increase of the company, it said that consumer demand is also on the response to the changes that occur.

## Green Key

Green Key Program, initiatives to protect the environment that supports rewarding, prevention of climate change and aims to contribute to sustainable tourism an international eco-label ([35]), given to businesses that meet environmental standards and accountability have created sustainable business in the hospitality industry (eco-label) is the reward ([38]). It has been implemented in Denmark in 1994 and is incorporated in France program in 1998. FEE was introduced in 2002 as the fifth

program. Green Key Program in Turkey is carried out since 2011 by TÜRÇEV. Green Key Award is given for a year and renewed re-apply every year. Green Key Award for field installations in Turkey it is first checked flag to the facilities meet the criteria are given plaques and certificates. Later in the year and also performed at least once in control of the facility does not meet the criteria are expected to be back before the year-end awards ([35]).

Green Key, environmental and sustainability issues in the tourism industry, which has worldwide guests, staff and suppliers primarily aim to create awareness for behavioral changes. Visitors to this inform guests and staff are given training on environmental awareness. Accommodation at the point of business to act as environmentally friendly, this award helps, aims to provide behavior will continue when they return home in visitor behavior. Green Key, for guests who prefer to stay in a hotel like this means a guarantee for the environment of the hotel. Green Key with expected high environmental standards in the hotel is protected through strict testing and frequent checks. Green Key program is an international award and adds value to business owners who bring international recognition ([38]). The criteria of the Green Key applications are grouped under 12 main headings. These; environmental management, staff training, informing the guests and awareness, water conservation, washing and cleaning, waste management, energy, food and beverages, indoor environment, green spaces and gardens, green activities, the administration and management. Reducing the environmental impact of the company Green Key program, energy and water saving, environmentally friendly use of cleaning materials and the protection of the environment through measures such as waste management, electricity, water, fuel, cleaning materials and waste, such as reducing the reduction in costs as a result of the consumption in matters of economic management aims to be performed. This application is the business of winning is another purpose and advantage in marketing the prestige of the Green Key label and the business of the exhibition is to raise awareness in the international arena. However, the business owner, increasing environmental awareness of staff and customers and aims to provide education for sustainable development. In general, the main purpose is to strengthen tourism contributing to sustainable tourism ([35]).

Table 2. Accommodation businesses having Green Key reward yearly

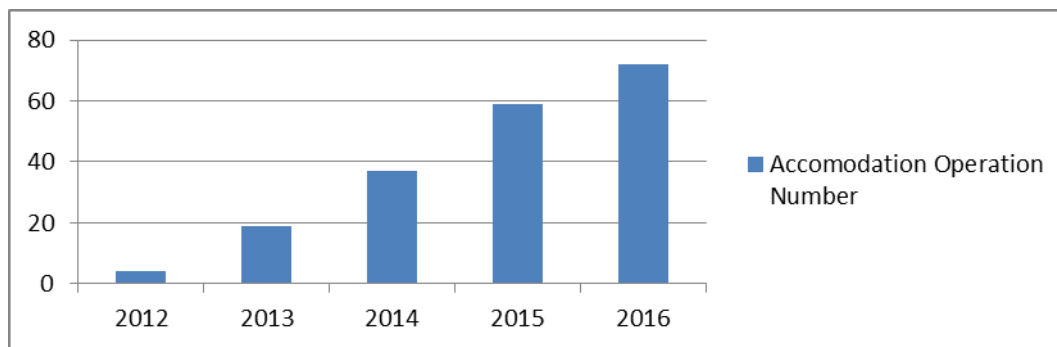

Reference: TÜRÇEV, 2016

As of 2016, there are 74 facilities in Turkey Green Key Award ([35], [39]). In the international arena under this program it is being implemented in 53 countries and a total of 2400 Green Key award-winning hotel business (pension, small accommodations, campgrounds, restaurants, and attractions) are available. Turkey began the program in 2002, although that practice has started late in 2011, it ranks 7th among 53 countries ([39]). Table 2 is observed when the green key to winning hospitality business has increased every year. Despite the adoption of the Green Key program internationally, countries with national acceptability sense, has not the necessary interest for its own eco-label or certification program developed and used. This is also true for accommodation businesses in Turkey.

### Green Star Environmentally Friendly Accommodations Certificate

In the context of sustainable tourism, Tourism Management with certified environmentally friendly accommodation is given provided they comply with certain criteria, existing tourism business is a kind of eco-label is written in environmentally sensitive facility should appear on the documents in the regulated green stars and plaques (eco-label) application ([40]). In the context of sustainable tourism, development of environmental protection and environmental awareness, tourist facilities on the environment to encourage the positive contributions and to be encouraged, Culture and Tourism Ministry by demanding since 1993 and with the qualifications established by the ministry to accommodation facilities, Eco-Friendly Certificate of Incorporation (Pine Icon) it is given. The concept of sustainability, sustainable tourism and environmental protection measures are being implemented for the environmentally conscious accommodation for businesses with increasingly gaining more importance in the world and in Turkey classification form, updated and improved. Certified Environmentally Responsible Tourism Management accommodations to accommodations/document has been given the green stars. After this notification green star began to practice in the hospitality business and removed a year later pine Icon ([36]).

By taking into account the developments and international benchmarks, which occurred about 122 basic criteria of environmental awareness, the hotel is in the city or coastal hotel situation in mind, is a modified scoring system. Minimum scores, taking into account the impact of the capacity and accommodation business environment, the company is determined according to the type and class. Type and facilities exceeding the set minimum scores for the class are eligible to receive a Certificate Green Star for two years, and this document under supervision of the Ministry in terms of business continuity Green Star is provided every two years. Green Star Certificate, accommodation is a project implemented voluntarily by businesses at the request of business tourist who work on environmental sensitivity, accommodation fulfills the basic criteria established practice in essentially the form of plants are taken into consideration.

The purpose of the Green Star environmental protection document is to promote the development of environmental awareness and environmentally sensitive structuring in the tourist accommodation business and management features. Green Star certificate application, water savings, increasing energy efficiency, environmentally harmful material consumption and reduce the amount of waste, to promote the use of renewable energy sources from the investment stage of accommodation establishments that they planned to be sensitive to the environment and their implementation, the adaptation to the environment of the plant, environmental beautifying arrangements and activities, ecological architecture, to raise awareness on environmental awareness, education support, the opinions of relevant institutions and organizations, cooperation and EU criteria in this respect (Eco-label) includes the general ([36]). Green Star certificate of credit facilities, while contributing to environmental protection, the promotion and marketing can create a privilege, without compromising the quality of service they can provide savings are considered. Although the preparation of the environmental label designed by the Ministry in accordance with EU criteria, is not an international eco-label. However, international environmental labels, it is observed that a lot of countries apply their own eco-labels. The most important benefits of electricity and the use of energy sources such as water to achieve savings in significant quantities brought to an accommodation facility of Green Star application and is not accompanied by a significant decrease in its direct operating costs ([40]). However, Green Star Certified by the business ministry, are electrical energy support.

### **White Star**

White Star Environmental Project, within Turkey Hoteliers Federation (TUROFED) has contributed to the sustainability of tourism and developed by Diversey certification program was launched in 2010. White Star program with some regulations, environmental standards; EU Flower and global environmental projects such as the Green Globe standards include international standards of energy and water saving program ([17]). Preventing the uncontrolled consumption by White Star Project is expected to turn into a conscious consumption. Used in the tourist business with the White Star Project is being implemented under the leadership of TÜROFED water, electricity, energy, the control of chemical and solid waste, the losses incurred for the environment and natural resources is expected to be minimized. Without compromising the comfort of the guests of the resort in the project, it is intended to be participants in the provision of this environmental sensitivity ([41], [42], [43]). The businesses that participate in the project, with investment from the initial stage and renovation investment, with conscious consumption and international standards work, only the average energy and water consumption in the tourism sector, are able to save the rate to 90 percent from 25 percent. White Star project participating tourism businesses not only contribute to ensuring a sustainable environment, through the reduction of costs along with increased customer satisfaction will gain economic benefits ([43]). All tourist businesses who are members of TÜROFED, including optional projects, an annual two stages and energy, water, hazardous chemicals, detergents and disinfectants, waste comes 55 criteria to occur involving other services and management. Businesses that meet the required criteria, are eligible to take the White Star. Project participants from the plant, the first year of the 25 pieces of the criteria to protect the environment, is expected to fulfill the second year and 30. At the end of the second year, tourist facilities in this project at the same time, the European Union ecological labeling criteria are being fulfilled ([41], [42]). White Star Environment Programme, there was no information about serving the purpose of the study. However, the place has been in operation for a certification system to be used in Turkey.

### **TUROB Greening Hotels Project**

Greening Hotels Project is to encourage the tourism facilities in “Sustainable Tourism” to be more green, environmentally friendly hotel is the creation and green accommodations, which aims to increase the number of certification programs. When in 2009 the 5th World Water Forum under the Turkey Union of Hoteliers (TUROB), the world’s leading one of the accreditation firm Bureau Veritas and control Sustainability Academy partnership was launched in 2010 ([44]). Greening Hotels Project, awareness of the sustainability of the tourism and hospitality industry and aims to increase their motivation to be sensitive to the environment ([45]). Greening Hotels provide an important contribution to the development of sustainable tourism project, increasing the number of environmentally conscious consumers, facilities are encouraged to be more green. Greening Hotels candidate facilities to receive the certificate; energy management, water management, improvement of indoor air quality, waste reduction and recycling are evaluated on four main areas, namely. The four main areas of the hotel are the lobby and public areas, rooms, dining room and the laundry, in the office space and office operations are evaluated through dozens of different criteria from one another and to successfully passing the hotel from this assessment “Greening Hotels” are given certificates. Control according to the minimum success over to take place is located in total by the on-site list, accommodation facilities, respectively Bronze (60% success), Silver (75% success) and gold (90% success) “Greening Hotels” are entitled to receive the document. The validity period of the certificate is two years, want to use the existing Greening Hotels hotel document after this period of time, can continue to use the documents by taking a half-day renewal audit ([44]).

Greening hotels certified energy and water management, improvement of indoor air quality, waste reduction and the improvements to be made in recycling issues, while contributing businesses to sustainable environmental policies, increase the service quality while reducing operating costs. To minimize the damage to the environment in which they live and the services they provide to the hotel that aims to make a firm principle. This certificate with both an awareness-raising as well as creating a secret corporate power, gain the advantage ([44]). Located competitive advantage to businesses in the tourism sector, becoming a leader in the industry, implementation of sustainable business models, customer satisfaction and sustainable while providing benefits such as being successful at managing change for the future; it also contributes to the conservation of natural resources and environmental sustainability ([45]). Hotels participating in the Greening Hotels Project, a 100-room hotel is able to save a minimum of 10 thousand pounds a year. While maintaining the environment, on the other hand, it is provided by the same service with less cost ([46]). In the hotel business, which was launched in Turkey in 2010 Greening Hotels certificate has a total of 53 hotels operating in Turkey as of 2016. Afyon, Balıkesir, Izmir, Marmaris and Tekirdag in 1 company; Ankara, Sakarya and Eskişehir in 2 companies; in Muğla 3 companies and in İstanbul 17, in Antalya 22 hotel operation has this certificate ([45]).

#### 4. CONCLUSION

Sustainable tourism, the tourism environment created by the source, appears to have emerged from concern about the effects that occur. The recognition of the environmental impacts of tourism and as a result of increasing demand for environmentally friendly tourism activities, sustainable practices in tourism has been gaining importance. Several countries in this context, the context of sustainable environmentally sustainable tourism will develop a variety of practices, carry out plans and policies. Therefore, the implementation of the national and international world, to increase awareness about the environment and to take practical steps to protect the environment, several environmental certifications applied optional and eco-label program has been implementing. These practices are used as an effective instrument in providing sustainability in tourism. The concept of sustainability and hospitality businesses with the importance of the concept of sustainable tourism as well as conducting studies to reduce the negative impacts of tourism and tourism to ensure the sustainability of the environment. By national and international organizations in the world with particular documents and awards some standardization are identified, certificate programs implemented and some practices can have tried to visit and encourage implementation with sustainable accommodation establishments and beach activities many awards nationally and internationally accepted in the world, there are eco-labels and certification programs. Tourism eco-labeling and certification programs are being implemented all over the world as an effective and the concrete implementation instrument for the development of sustainable tourism and have increasingly being used.

However, these practices, affecting tourists are among the preferred vacation. These developments in the world of tourism and hospitality business, certificate programs, rewards, eco-labels and increased as a result of the standard, Culture and Tourism Ministry and tourism related some organizations in Turkey (TUROB, TUROFED, TÜRÇEV) has developed several practices for industry and environmental sustainability. Protection of the environment on the beaches that make up the environment in the hospitality business and hospitality business in Turkey and internationally recognized Blue Flag which is provided in the context of sustainable tourism and the Green Key eco-label is applied. However, national as Green Star, White Star and Greening Hotels certification program has developed and implemented. Turkey, if the hospitality business and these practices will be assessed within the scope of the beaches that make up the environment;

-Blue Flag eco-label worldwide, including 30 countries in Europe are implemented in 50 countries. A result of the evaluations performed in 2016. Turkey, which has 588 blue flag beaches with 444 beaches in 50 countries and is located on the beach 2 ranking after Spain. A total of 2400 Green Key award-winning hotels and businesses under the Green outline practice has been implemented in 53 countries in the international arena (small accommodations, campgrounds, restaurants ...) are available. As of 2016, the Green Key Award has 72 facilities in Turkey, and Turkey ranks 7th among 53 countries. Sensitive to environmental accommodations in Turkey as of August 31, 2016 has certified 357 facilities. Turkey has 31 provinces across the green star facility with a maximum green star resort in Antalya province with 186 plants. As of 2016, 11 different cities in Turkey, a total of 53 hotel properties have Greening Hotels Certificate.

All in all, the tourism industry is an important sector for Turkey, the use of eco-labels and certification programs are increasing year by year. For Turkey this case, the effects of tourism on the environment shows that efforts are made to be minimized. Besides these practices, it is to provide direct and positive contribution to sustainable tourism development and competitive advantage for businesses. The number of Turkey's economic and social development in an important place in having environmentally sensitive facility on behalf of the sustainability of the tourism sector should be increased. The future of tourism in terms of Turkey's tourism depends on sustainable tourism practices. In the tourism sector, certification and eco-labeling practices awareness to people about the environment and people's behavior can help to make permanent changes. These studies will increase the preference for awareness of environmentally friendly tourist accommodation by the company in Turkey.

#### REFERENCES

- [1] S. Baysan, *Turizm: İlkeler ve Yönetim*, 1nd ed., A. Yüksel and M. Hançer, Ed. Ankara, Turkey: Turhan Kitabevi Yayınları, 2004.
- [2] N. Dal, and S. Baysan, "Kuşadası'nda kıyı kullanımı ve turizmin mekansal etkileri konusunda yerel halkın tutumları," *Ege Coğrafya Dergisi*, vol. 16, pp. 69-85, 2007.
- [3] L. Atay, and S. E. Dilek, "Konaklama işletmelerinde yeşil pazarlama uygulamaları: İbis Otel örneği," *Süleyman Demirel Üniversitesi İktisadi ve İdari Bilimler Fakültesi Dergisi*, vol. 18, pp. 203-219, 2013.
- [4] C. Lim, and M. McAleer, "Ecologically sustainable tourism management," *Environmental Modelling & Software*, vol. 20, pp. 1431-1438, 2005.
- [5] G. Seyhan, and B. S. Yılmaz, "Sürdürülebilir turizm kapsamında konaklama işletmelerinde yeşil pazarlama, Calista Lüks Resort Hotel," *İşletme Fakültesi Dergisi*, vol. 11, pp. 51-74, 2010.
- [6] Ç. Demir and A. Çevirgen, *Turizm ve Çevre Yönetimi*, Ankara, Turkey: Nobel Yayınevi, 2006.
- [7] İ. Giritlioğlu, and M. O. Güzel, "Otel işletmelerinde yeşil yıldız uygulamaları: Gaziantep ve Hatay bölgesinde bir araştırma," *Uluslararası Sosyal Araştırmalar Dergisi*, vol. 8, pp. 889-904, 2015.
- [8] G. Güneş, "Konaklama sektöründe çevre dostu yönetimin önemi," *Karamanoğlu Mehmetbey Üniversitesi Sosyal ve Ekonomik Araştırmalar Dergisi*, vol. 13, pp. 45-51, 2011.
- [9] A. Baytok, E. Pelit, F. Gökçe, and Y. Gökçe, "Sürdürülebilirlik kapsamında termal otel işletmelerinde atık yönetimi uygulamaları: Sandıklı örneği," *Gümüşhane Üniversitesi Sosyal Bilimler Elektronik Dergisi*, vol. 6, pp. 1-11, 2015.
- [10] A. Altanlar, and G. Akıncı Kesim, "Sürdürülebilir turizm planlaması için yöre halkı ve yerli turistlerin davranış ve beklentilerini anlamaya yönelik bir araştırma; Akçakoca örneği," *Ankara Üniversitesi Çevre Bilimleri Dergisi*, vol. 3, pp. 1-20, 2011.
- [11] G. Alagöz, E. Güneş, and A. Uslu, "Otel işletmeleri ve seyahat acentaları yöneticilerinin sürdürülebilir turizme bakış açısı: bir alan araştırması," *Gümüşhane Üniversitesi Sosyal Bilimler Elektronik Dergisi*, vol. 6, pp. 83-98, 2015.
- [12] D. Buhalis, "Marketing the competitive destination of the future," *Tourism Management*, vol. 21, pp. 97-116, 2000.
- [13] P. Başgöze, and N. A. Bayar, "Eko otellerden hizmet satın alınımında kuşaklar arası farklılaşmalar üzerine bir çalışma," *Sosyoekonomi Dergisi*, vol. 23, pp. 118-130, 2014.



- [14] N. Kahraman and O. Türkay, *Turizm ve Çevre*, Ankara, Turkey: Detay Yayıncılık, 2006.
- [15] G. Çakır, and A. Çakır, "Konaklama tesislerinde sürdürülebilir turizm kapsamında su kaynaklarının korunmasına yönelik uygulamalar," *Tarım Bilimleri Araştırma Dergisi*, vol. 3, pp. 31-36, 2010.
- [16] A. Ş. Tekeltürk and M. Boz, *Turizmde Güncel Konu ve Eğilimler: Sürdürülebilir Bir Yatırım Örneği Olarak Yeşil Otelcilik*, 1nd ed., O. Güler and E. Tufan, Ed. Ankara, Turkey: Detay Yayıncılık, 2013.
- [17] F. Kutluay Tutar, "Yeşil ekonomi, yeşil turizm: Türkiye'de turizm sektöründe yeni trend yeşillenen oteller projesi," *Akademik Sosyal Araştırmalar Dergisi*, vol. 3, pp. 328-352, 2015.
- [18] M. Türk, and M. Harbalıoğlu, "Konaklama işletmelerinde çevreye duyarlılık," *Akademik Sosyal Araştırmalar Dergisi*, vol. 3, pp. 419-428, 2015.
- [19] N. Kuter, and H. E. Ünal, "Sürdürülebilirlik kapsamında ekoturizmin çevresel, ekonomik ve sosyo-kültürel etkileri," *Kastamonu Üniversitesi Orman Fakültesi Dergisi*, vol. 9, pp. 146-156, 2009.
- [20] K. S. Nepal, "Tourism in protected areas The Nepalese Himalaya," *Annals of Tourism Research*, vol. 27, pp. 661-681, 2000.
- [21] N. Erdoğan, "Ekoturizm: gelişimi ulusal, bölgesel ve uluslararası anlaşmalardaki yeri," 2007.
- [22] Y. Leung, J.L. Marion, and T.A. Farrell, *The Role of Recreation Ecology in Sustainable Tourism and Ecotourism*, S. McCool and R. N. Moisey, Ed. in *Tourism, Recreation, and Sustainability: Linking Culture and the Environment*, Newyork: CABI Publishing, 2001.
- [23] M. Somuncu, and T. Yiğit, "Göreme Milli Parkı ve Kapadokya Kayalık Sitleri dünya mirası alanı'ndaki turizmin sürdürülebilirlik perspektifinden değerlendirilmesi," Ankara: V. Ulusal Coğrafya Sempozyumu, s. 16-17, 2009.
- [24] Ü. Şahin, "Bir truva atı olarak sürdürülebilir kalkınma," *Üç Ekoloji Dergisi*, vol. 2, pp. 9-30, 2004.
- [25] (2005) UNWTO website. [Online]. Available: <http://sdt.unwto.org/content/about-us-5>
- [26] C. Alkan, "Sürdürülebilir turizm: Alaçatı destinasyonuna yönelik bir uygulama," *Journal of Yasar University*, vol. 10, pp. 6692-6710, 2015.
- [27] S. Gössling, "Ecotourism: a means to safeguard biodiversity and ecosystem function?," *Ecological Economics*, vol. 29, pp. 303-320, 1999.
- [28] N. Türker, and M. Uçar, "Konaklama işletmelerinin sosyal sorumlulukları," *İşletme Araştırmaları Dergisi*, vol. 5, pp. 155-183, 2013.
- [29] M. Yücel, and Ü. S. Ekmekçiler, "Çevre dostu ürün kavramına bütünsel yaklaşım: temiz üretim sistemi, eko-etiket, yeşil pazarlama," *Elektronik Sosyal Bilimler Dergisi*, vol. 7, pp. 320-333, 2008.
- [30] (2015) GEN website. [Online]. Available: <http://www.globalecolabelling.net/what-is-eco-labelling/>
- [31] A. Drakopoulou, "Tourism certification and community-based ecotourism as tools for promoting sustainability in the Greek tourism sector - the example of Zagori," M. thesis, Lund University Environmental Sciences, Helsingborg, Sweden, 2011.
- [32] X. Font, "Environmental certification in tourism and hospitality: progress, process and prospects," *Tourism Management*, vol. 23, pp. 197-205, 2002.
- [33] S. Capacci, A. E. Scorcu, and L. Vici, "Eco labels and tourism flows: How much is a Blue Flag worth?," Working Paper. Bologna, Italy, 2014.
- [34] R. Fişkın, E. Çakır, and E. D. Özkan, "Mavi bayrak uygulamasının önemi, ölçütleri ve ülkelere göre durum değerlendirmesi," *Mehmet Akif Ersoy Üniversitesi Sosyal Bilimler Enstitüsü Dergisi*, vol. 8, pp. 224-247, 2016.
- [35] (2016) TÜRÇEV website. [Online]. Available: <http://www.turcev.org.tr/>
- [36] (2016) Kültür ve Turizm Bakanlığı, website. [Online]. Available: <https://www.kultur.gov.tr/TR,96268/turizm.html>
- [37] M. Ayan, "Çevre kalite yönetim sistemlerinin bir konusu olarak mavi bayrak projesi ve Haliç'te uygulanmasına yönelik bir çalışma," *International Environment and Morality Symposium*, 24-26.10.2014.
- [38] (2016) The FEE website. [Online]. Available: <http://www.fee.global/green-key-1/>
- [39] (2016) The Greenkey website. [Online]. Available: <http://www.greenkey.global/>
- [40] (2016) The ÇEV-KA website. [Online]. Available: <http://www.cev-ka.com/>
- [41] (2016) The TUROFED website. [Online]. Available: <http://www.turofed.org.tr/>
- [42] N. Dolmacı, and G. Bulgan, "Turizm etiği kapsamında çevresel duyarlılık," *Journal of Yasar University*, vol. 29, pp. 4853-4871, 2013.
- [43] İ. Kızılırmak, "Dünyada ve Türkiye'deki turizm işletmelerinde çevre korumaya yönelik uygulamalar: amacı ve önemi," *Sosyal Bilimler Dergisi*, vol. 2, pp. 1-12, 2011.
- [44] (2016) TUROB Greening Hotels website. [Online]. Available: <http://www.turob.com/greening/index.html#>
- [45] (2016) Greening Hotels website. [Online]. Available: <http://www.yesillenenoteller.com/>
- [46] (2016) TUROB website. [Online]. Available: <http://www.turob.com/haber.aspx?id=12431>

# Empirical Analysis on the Running Time of a Searching Algorithm, Chunk Algorithm

Gazmend Xhaferi<sup>1</sup>, Florinda Imeri<sup>2</sup>, Flamure Sadiku<sup>3</sup>, Agon Memeti<sup>4</sup>

---

## Abstract

Searching and sorting, by no doubt, represent two of the most fundamental and widely encountered problems in computer science. Given a collection of objects, the goal of search is to find a particular object in this collection or to recognize that the object does not exist in the collection. A major goal of computer sciences is to understand and develop a solution for the particular problem. Typically solving the problem involves at least four steps: (1) design an algorithm, (2) analyze the correctness and efficiency of the procedure, (3) implement that procedure in some programming language, and (4) test that implementation. An important issue is to describe the efficiency of a given procedure for solving a problem. Informally, usually we speak in terms of “fast” or “slow” programs, but the absolute execution time of an algorithm depends on many factors such as: the size of the input, the programming language used to implement the algorithm, the quality of the implementation and the machine on which the code is run (a supercomputer is faster than a laptop). In this paper we will analyze the performances of a searching algorithm, precisely the chunk algorithm. In analyzing the efficiency of chunk algorithm, we will only concentrate on searching items, using the Chunk-Search Algorithm, on one-dimensional arrays with integers. We wanted to see how does different chunk size, input size (i.e., the “speed” of the algorithm as a function of the size of the input on which it is run), and the machine on which the code is run.

**Keywords:** chunk algorithm, computer performance, input size, chunk size

---

## 1. INTRODUCTION

There are some very common problems that we use computers to solve: searching through a lot of records for a specific record or set of records and sorting, or placing records in a desired order. At times we need to use both of these techniques as part of solving the same problem. There are numerous algorithms to perform searches and sorts.

A question you should always ask when selecting a search algorithm is “How fast does the search have to be?” The reason is that, in general, the faster the algorithm is, the more complex it is.

The concept of efficiency (or complexity) is important when comparing algorithms. For long lists and tasks, like searching, that are repeated frequently, the choice among alternative algorithms becomes important because they may differ in efficiency.

Before we can compare different methods of searching we need to think a bit about the time requirements for the algorithm to complete its task. We could also compare algorithms by the amount of memory needed.

An algorithm can require different times to solve different problems of the same size (a measure of efficiency). For example, the time it takes an algorithm to search for the integer ‘1’ in an array of 100 integers depends on the nature of the array.

How can one describe the efficiency of a given procedure for solving some problem? Informally, one often speaks of “fast” or “slow” programs, but the absolute execution time of an algorithm depends on many factors:

- the size of the input (searching through a list of length 1,000 takes longer than searching through a list of length 10),
- the algorithm used to solve the problem (Unordered-Linear-Search is inherently slower than Binary-Search),
- the programming language used to implement the algorithm (interpreted languages such as Basic are typically slower than compiled languages such as C++),
- the quality of the actual implementation (good, tight code can be much faster than poor, sloppy code), and
- the machine on which the code is run (a supercomputer is faster than a laptop).

---

<sup>1</sup>Florinda Imeri, University of Tetova, Faculty of Math. & Nat. Sciences, Department of Informatics, Tetovo, Macedonia, [florinda.imeri@unite.edu.mk](mailto:florinda.imeri@unite.edu.mk)

<sup>2</sup>Gazmend Xhaferi, University of Tetova, Faculty of Math. & Nat. Sciences, Department of Informatics, Tetovo, Macedonia, [gazmend.xhaferi@unite.edu.mk](mailto:gazmend.xhaferi@unite.edu.mk)

<sup>3</sup>Flamure Sadiki, University of Tetova, Faculty of Math. & Nat. Sciences, Department of Mathematics, Tetovo, Macedonia, [flamure.sadiki@unite.edu.mk](mailto:flamure.sadiki@unite.edu.mk)

<sup>4</sup>Agon Memeti, University of Tetova, Faculty of Math. & Nat. Sciences, Department of Informatics, Tetovo, Macedonia, [agon.memeti@unite.edu.mk](mailto:agon.memeti@unite.edu.mk)

In analyzing the efficiency of an algorithm, one typically focuses on the first two of these factors i.e., the “speed” of the algorithm as a function of the input size and the machine on which it is run. Finally, when analyzing the efficiency of an algorithm, one often performs a worst case and/or an average case analysis.

A worst case analysis aims to determine the slowest possible execution time for an algorithm. For example, if one were searching through a list, then in the worst case, one might have to go through the entire list to find (or not find) the object in question. A worst case analysis is useful because it tells you that no matter what, the running time of the algorithm cannot be slower than the bound derived. An algorithm with a “good” worst case running time will always be “fast.” On the other hand, an average case analysis aims to determine how fast an algorithm is “on average” for a “typical” input. It may be the case that the worst case running time of an algorithm is quite slow, but in reality, for “typical” inputs, the algorithm is much faster: in this case, the “average case” running time of the algorithm may be much better than the “worst case” running time, and it may better reflect “typical” performance.

Average case analyses are usually much more difficult than worst case analyses. In actual practice, the average case running time of an algorithm is usually only a constant factor (often just 2) faster than the worst case running time. Since worst case analyses are (1) interesting in their own right, (2) easier to perform than average case analyses, and (3) often indicative of average case performance, worst case analyses tend to be performed most often.

With this as motivation, we now analyze the performances of the algorithm Chunk-Search.

## 2.A REVIEW OF THE CHUNK-SEARCH ALGORITHM

Given an ordered list, one need not (and one typically does not) search through the entire collection one-by-one. Consider searching for a name in a phone book or looking for a particular exam in a sorted pile: one might naturally grab 50 or more pages at a time from the phone book or 10 or more exams at a time from the pile to quickly determine the 50 page (or 10 exam) “chunk” in which the desired data lies. One could then carefully search through this chunk using an ordered linear search. Let  $c$  be the chunk size used (e.g., 50 pages or 10 exams), and assume that we have access to a slightly generalized algorithm for ordered linear search, Encoding the above ideas; we have the chunk search algorithm [2].

Input: ordered objects array  $A$ , the number of objects  $n$ , chunk size  $c$ , key value being sought  $x$ .

Output: if found, return position  $i$ , if not, return message “ $x$  not found”

- a. Cut array  $A$  into chunks of size  $c$ .
- b. Compare  $x$  with the last elements of each chunk, except the last chunk! See if  $x$  is GREATER than that element.
- c. If yes, check the next chunk
- d. If no, that means  $x$  should be in that chunk
- e. Execute Ordered Linear Search inside the chunk

A pseudo code for the algorithm chunk-search is as below:

**Chunk-Search** [ $A$ ,  $n$ ,  $c$ ,  $x$ ]

**high**  $\leftarrow c$

**while** **high**  $< n$  and  $A[\text{high}] < x$

**do** **high**  $\leftarrow \text{high} + c$

**high**  $\leftarrow \min\{\text{high}, n\}$

**low**  $\leftarrow \max\{\text{high} - c + 1, 1\}$

**return** **Ordered-Linear-Search**[ $A$ , **low**, **high**,  $x$ ]

The call to Ordered-Linear-Search will be performed on a list whose size is at most  $c$ , and thus at most  $2c$  additional comparisons will be performed (as described above). We therefore have

$$T(n) = n/c + 2c. \quad [1]$$

Note that the running time of Chunk-Search depends on both  $n$  and  $c$ . What does this analysis tell us? We can use this analysis, and specifically equation [1], in order to determine the optimal chunk size  $c$ ; i.e., the chunk size which would minimize the overall running time of Chunk-Search (in the worst case).

Suppose that one were to run Chunk-Search using a very small value of  $c$ . Our chunks would be small, so there would be lots of chunks. Much of the time would be spent trying to find the right chunk.

Consider the extreme case of  $c = 1$ : in the worst case,  $n/c = n/1 = n$  comparisons would be spent trying to find the right chunk while only  $2c = 2$  compares would be spent searching within a chunk for a total of  $n + 2$  compares (in the worst case). This is worse than Ordered-Linear-Search (though it is still linear)[1].

Now consider using a very large value of  $c$ . Our chunks would be big, so there would be few of them, and very few comparisons would be spent finding the right chunk. However, searching for the element in question within a very large chunk would require many comparisons. Consider the extreme case of  $c = n$ : in the worst case,  $n/c = n/n = 1$  comparison would be spent “finding” the right chunk (our chunk is the entire list) while  $2c=2n$  compares would be spent searching within a chunk for

a total of  $2n + 1$  compares (in the worst case). This is worse than either Unordered-Linear-Search or Ordered-Linear-Search (though, again, it is still linear).

Is Chunk-Search doomed to be no faster than linear search? No! One must optimize the value of  $c$  in order to minimize the total number of comparisons, and this can be accomplished by choosing a value of  $c$  which balances the time (number of comparisons) spent finding the right chunk and the time spent searching within that chunk. Suppose that we wish to spend precisely equal amounts of time searching for the correct chunk and then searching within that chunk; what value of  $c$  should we pick? Our goal is then to find a  $c$  such that  $n/c$  (the time spent searching for a chunk) is equal to  $2c$  (the time spent searching within a chunk)[4].

$$n/c = 2c$$

$$n = 2c^2$$

$$n/2 = c^2$$

$$c = \sqrt{n/2}$$

Thus for  $c = \sqrt{n/2}$   $T(n) = \frac{n}{c} + 2c = 2\sqrt{2n}$

By this we answer the above question that for  $n/c = 2c$ ,  $T(n)$  is optimized

Note that for sufficiently large  $n$ , this is much faster than a linear search. For example, if  $n=1,000,000$ , Ordered-Linear-Search would require 2,000,000 comparisons in the worst case, while Chunk-Search would require approximately 2,828 comparisons in the worst case— Chunk-Search would be approximately 707 times faster (in the worst case).

Do even better values of  $c$  exist? One can show through the use of calculus that  $c = \sqrt{n/2}$  is optimal. We essentially have a function  $(n/c + 2c)$  which we wish to minimize with respect to  $c$ . Taking the derivative with respect to  $c$ , setting this derivative to zero, and solving for  $c$  yields  $c = \sqrt{n/2}$ .

### 3.RESULTS AND DISCUSSION

In this study we will only concentrate on searching items, using the Chunk-Search Algorithm, on one-dimensional arrays with integers. We wanted to see how does different

- chunk size, input size, and hardware (computers) influence the speed.

The tests were run in computers with different characteristics:

1. CPU: Intel(R) Core (TM) i3 2.2 GHz, 6 GB RAM (PC1)
2. CPU: Intel® Core™ i7-4720HQ CPU @ 2.60GHz; 8,00 GB RAM (PC2)

In order to test the speed of different input size, chunk size and different computer performances, we made a C++ program which runs Chunk-Search Algorithm several times for randomly-generated arrays of different size: 10000, 20000, 30000, 40000, 50000, 60000, 70000, 80000, 90000 and 100000 items (integers). Measurements for the Chunk-Search algorithm, where the array will be divided into chunk size of  $c = 1, c = 50, c = 100, c = 250, c = 500, c = 750, c = 1000$

The first experiment was conducted for different sizes of chunks, on different array size. Below are shown results

Table 8. The execution time for Chunk-Search algorithm, for different chunk and array size

	Input size/chunk size	c=1	c=50	c=100	c=250	c=500	c=750	c=1000
PC 1	10000	0.027	0.031	0.055	0.054	0.053	0.031	0.030
PC 2		<b>0.008</b>	<b>0.004</b>	<b>0.008</b>	<b>0.005</b>	<b>0.006</b>	<b>0.008</b>	<b>0.004</b>
PC 1	50000	0.037	0.026	0.056	0.054	0.057	0.025	0.028
PC 2		<b>0.011</b>	<b>0.012</b>	<b>0.011</b>	<b>0.012</b>	<b>0.028</b>	<b>0.008</b>	<b>0.012</b>
PC 1	75000	0.033	0.035	0.032	0.027	0.028	0.018	0.025
PC 2		<b>0.012</b>	<b>0.012</b>	<b>0.012</b>	<b>0.012</b>	<b>0.009</b>	<b>0.021</b>	<b>0.009</b>
PC 1	100000	0.017	0.019	0.021	0.027	0.015	0.012	0.018
PC 2		<b>0.015</b>	<b>0.012</b>	<b>0.012</b>	<b>0.008</b>	<b>0.008</b>	<b>0.012</b>	<b>0.013</b>

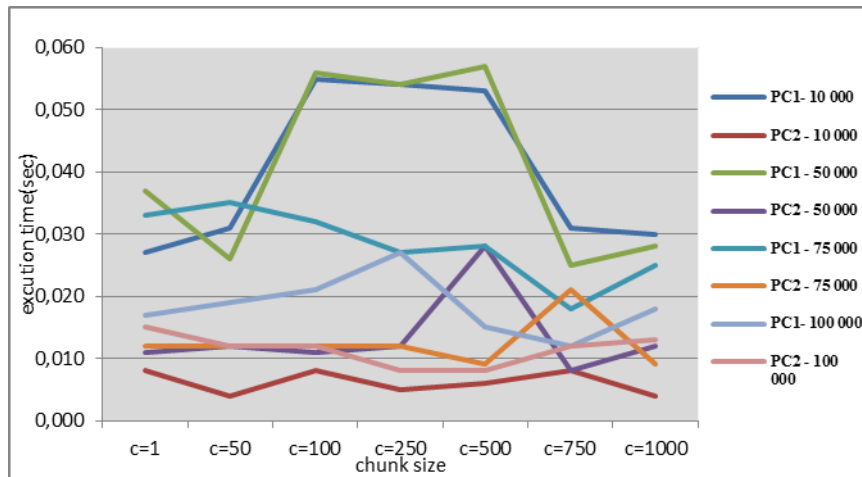

Figure 22. The graph for the Chunk-Search algorithm for different chunk and array size

The second experiment was conducted for different input size, for the chunk size which presents an optimum, **c = 1000**

Table 2. The execution time for the Chunk-Search algorithm to chunk size of 1000.

no. of elements in the array	no. of blocks	exec. time (PC 1) c=1000	exec. time (PC 2) c=1000
10 000	10	0.024	0.006
20 000	20	0.038	0.013
30 000	30	0.039	0.011
40 000	40	0.039	0.012
50 000	50	0.038	0.011
60 000	60	0.039	0.01
70 000	70	0.040	0.01
80 000	80	0.026	0.011
90 000	90	0.022	0.012
100 000	100	0.020	0.009

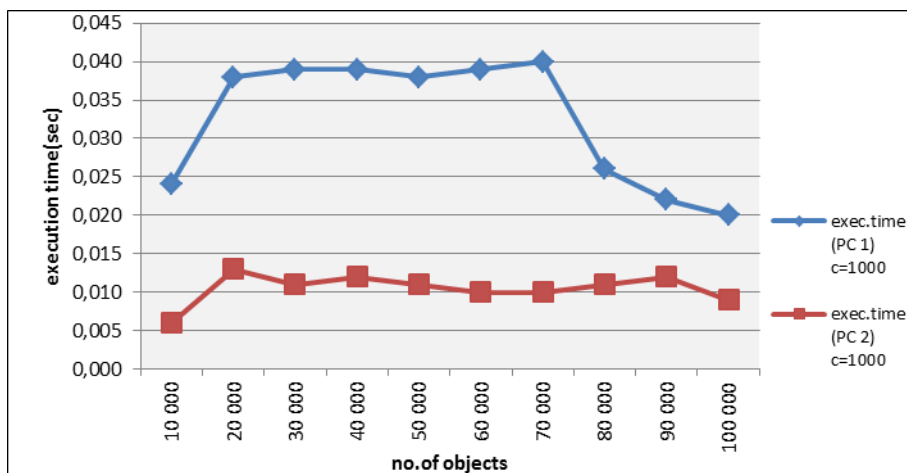

Figure 2. The graph for Chunk-Search algorithm to chunk size of 1000

The third experiment was conducted for different computer performances for the chunk size **c=100**:

Table 3. The execution time for the Chunk-Search algorithm to chunk size of 100

no. of elements in the array	no.of blocks	exec.time (PC 1) c=100	exec.time (PC 2) c=100
<b>10 000</b>	100	<b>0.029</b>	<b>0.007</b>
<b>20 000</b>	200	<b>0.054</b>	<b>0.015</b>
<b>30 000</b>	300	<b>0.053</b>	<b>0.010</b>
<b>40 000</b>	400	<b>0.048</b>	<b>0.010</b>
<b>50 000</b>	500	<b>0.038</b>	<b>0.010</b>
<b>60 000</b>	600	<b>0.032</b>	<b>0.011</b>
<b>70 000</b>	700	<b>0.020</b>	<b>0.009</b>
<b>80 000</b>	800	<b>0.018</b>	<b>0.011</b>
<b>90 000</b>	900	<b>0.018</b>	<b>0.011</b>
<b>100 000</b>	1 000	<b>0.019</b>	<b>0.010</b>

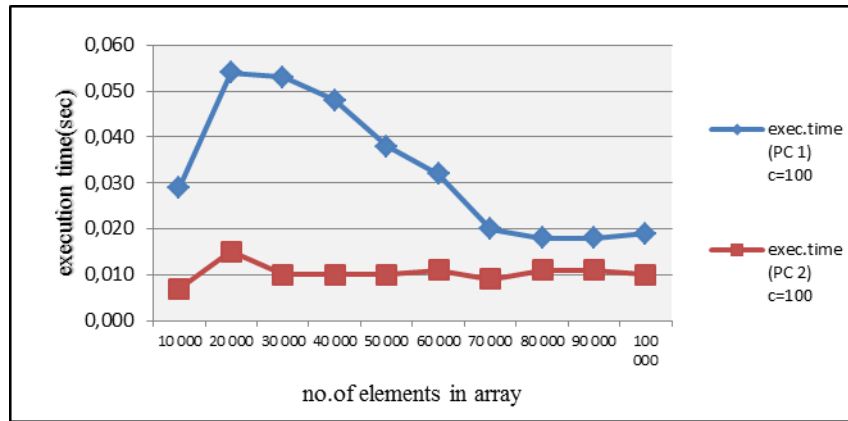

Figure 3. The graph for Chunk-Search algorithm to chunk size of 100

From the first experiment, the case 1, with the chunk size of 1, tab 1. and the fig 1., we see that with increasing of the input size, the overall execution time increases. Similarly to case 1 but with small change are the case 2. For the second case, where the chunk size is 1000, it is seen that with the increasing of the input size from 10000 to 50000 the execution time increases, and then decreases, tab.2 and fig.2. Similarly happens with the third case, where the chunk size is 100, tab.3. and fig.3.

From the empirical analysis of the algorithm and from the experimental one we can conclude that Chunk-Search algorithm has the fastest time in the cases when the chunk size is approximately equal to the number of elements in the input array. The best can be seen in the third case where the chunk size is 100 and the number of elements in the input array is 10000, where each chunk has 100 elements. So, in this case the execution time is 0.007 seconds, which is an optimal time or we can say that the algorithm performs the best.

In the third case it is also was analyzed and compared the algorithm Chunk-Search on two different computers with the different performances as regarding the CPU speed and memory capacity. Analyses were conducted for the chunk size of 100. The best is seen from table and graph above, tab.3 and fig.3, therefore, the execution time varies depending on the speed of the computer, which is with no doubt one of the factors that affect the speed of the algorithm.

#### 4.CONCLUSIONS

From the results derived, shown in the above tables and graphs, and from the empirical analysis of algorithm Chunk-Search is seen that the execution speed of this algorithm is directly affected by the chunk size and the machine performances.

As it is shown empirically we get the optimum in the case when the chunk size and the input size  $c = \sqrt{n/2}$ . Also it is very clear from the third experiment that the performances of the machine affect the speed of algorithm, as the computers with the best performances suggest that the algorithm will be faster and vice versa.

**REFERENCES**

- [1] Profs. Aslam & Fell, *Analysis of Algorithms: Running Time* September 7, 2005. Available from <http://www.psnacet.edu.in/courses/MCA/Design%20and%20analysis%20of%20Algorithms/Lecture1.pdf> (Accessed June, 2016).
- [2] A. Levitin. *Introduction to the Design and Analysis of Algorithms*. 3e, Addison-Wesley, 2011. ISBN 978-0132316811.
- [3] Searching Arrays: Algorithms and Efficiency. Available from <http://research.cs.queensu.ca/home/cisc121/2006s/webnotes/search.html> (Accessed June, 2016).
- [4] Thomas H. Cormen, Charles E. Leiserson, Ronald L. Rivest, and Clifford Stein. *Introduction to Algorithms*, Second Edition. MIT Press and McGraw-Hill, 2001. ISBN 0-262-03293-7. Bentley, Programming Pearls, Addison-Wesley
- [5] R. Sedgwick, *Bundle of Algorithms in C++*, Addison-Wesley, 2001, 3rd Edition.
- [6] Design and Analysis of Algorithms, Available from <https://www.cs.cornell.edu/~kozen/papers/daa.pdf> (Accessed October, 2015)

# Ethnomedicinal Aspects of Some Weeds of Rahoves Region, Kosovo

*Haxhi Halilaj<sup>2</sup>, Pirro Icka<sup>2</sup>, Avdyl Bajrami<sup>1</sup>, Robert Damo<sup>2</sup>*

---

## Abstract

*Wild edible plants, and particularly weeds, continue to play an important role as medicinal plants for many people around the world. In Kosovo, some of these plants are widely used in medicinal ethnobotany, and a number of species are considered as weeds in crops. Region of Rahovec, Kosovo, is a territory of diverse plant use traditions, which are still insufficiently documented. The aim of this study is to document local ethnomedicinal practices of using weeds on this region.*

*The present paper deals with observation on ethnomedicinal use of some weeds by the local people. Fieldwork was focused on the weeds of crop fields and vineyards of Rahovec, via survey conducted during 2015 and spring 2016. The paper presents the report of 40 weeds of medicinal importance, which have been used by rural people for the treatment of several diseases like respiratory, stomach, kidney disorders, diabetes, nervous disorder, skin disease, cough, cold, fever, weakness, diarrhea, blood purification, etc.*

*The data presented here include their botanical name followed by the family, vernacular name, English name and therapeutics uses. Data are presented showing the significant representation of weeds in the medicinal floras of the Rahoves and in the medicinal flora of Kosovo as a whole.*

**Keywords:** *ethnobotany, ethnomedicine, medicinal plant, traditional knowledge, weeds.*

---

## 1. INTRODUCTION

Plants are a rich source of many natural products. In Kosovo, and not only, some of them are widely used in medical ethnobotany or as plants for pharmaceutical aims, and a number of species are considered as weeds in crops. The species which grow on their own, without human efforts can be termed as weeds. Weeds are plants “out of place” in cultivated fields, lawns and other places i.e., a plant growing where it is not wanted [1] and that interfering with the objectives or requirements of people [2]. In the ecological context, a weed is a plant that grows spontaneously in an environment that has been modified by man and in the weed science context, weed mean an unwanted plant. According to Zimdal [2], the weed is a plant that forms populations that are able to enter habitats cultivated, markedly disturbed or occupied by man, and potentially depress or displace the resident plant populations which are deliberately cultivated or are of ecological and/or aesthetic interest. Weeds are those plants that are successful in disturbed environments, short-lived, fast-growing and oftentimes, herbaceous [3].

Weeds are unwanted and undesirable plants that interfere with the utilization of land and water resources and thus adversely affect crop production and human welfare. They grow along with the agro-ecosystems and are regarded as nuisance for crops. However, some weeds are called, “beneficial plants or herbs” as they are edible to humans because those serve as food, medicinal plants or other resources for human beings and can accomplish a number of roles in the garden or yard, including soil erosion control, fertilizing the soil, increasing moisture, acting as shelter or living mulch, repelling pests, attracting beneficial insects, etc.

Many of the weeds are raw materials to the pharmaceutical industries as they contain chemical compounds which are biologically active and potentially useful for medical science and used in formulation of various drugs [4]. Some drugs are sometimes hidden in “ordinary” plants, i.e. in wide spread ruderal and weed species whose extracts have been recently appointed in term of respectable antioxidant and/or antimicrobial activity [5]. Many of these species are well appreciated and known throughout the world for their high nutritional value and medicinal properties. A large variety of weeds is used in traditional medicine. There are long data on traditional use of several weeds and/or wasteland species. Such weeds can be collected from crop fields and used for curing the diseases.

Globally, the utilization of weeds has been patchy over the past few decades. Nevertheless, there is a renewed interest in focusing on utilization of weeds in productive ways [6], the role of weeds in the present pharmacopeia [3], or in traditional medicinal floras [7] has been overlooked [3], [7]. Because of the rapid loss of the diversity of plants, natural habitats, traditional community life, cultural diversity and knowledge of medicinal plants, documentation of medicinally important weeds is an urgent matter [8]. Therefore, documentation of the traditional ethnomedicinal knowledge (TEK) about medicinal weeds through ethnobotanical studies is important for the conservation and utilization of biological resources before such rich heritages are lost due to various factors, so that people may benefit from an aspect that has been largely ignored.

---

<sup>1</sup> Corresponding author: University “Fan S. Noli”, Faculty of Agriculture, Korçë, Albania, [bajramiavdyl@gmail.com](mailto:bajramiavdyl@gmail.com)

<sup>2</sup> University “Fan S. Noli”, Faculty of Agriculture, Korçë, Albania, [damo-ro@hotmail.com](mailto:damo-ro@hotmail.com)



In Kosovo there is an increased interest on ethnobotanical studies, but there are no studies on the importance of *ethnomedicinal weeds*, although they are common in agro-ecosystems. The present study was the first attempt to know the importance of weeds in reference to medicinal uses in the area. The main aim of this study was not only to explore and document the medicinal uses of some weeds growing along with the crop plants land and used by local people of Rahovec region in Kosovo, but also drawing attention to TEK that are in danger of being lost. In this paper “medicinal weeds” are defined as wild medicinal plant species (according to the emic conceptualization of farmers in Rahovec region) that are classified as a “weed” in the scientific literature [2], [9]-[11].

## 2. MATERIALS AND METHODS

An ethnobotanical exploration was made to find out the medicinal use of common weeds present in crop fields and vineyards on different places of Rahovec region (Kosovo) during 2015 and spring 2016. The Rahovec municipality territory lies in the latitude from 42° 30' to 42° 50' and in the longitude from 20° 21' to 20° 55'.

The survey included 43 selected villagers (between 43 and 84 years of age) in seven villages, with the majority of the informants above 65 years of age, mainly farmers, traditional herbal medicine practitioners or retired workers, who still manage some work in agricultural fields.

Interviews were conducted using a semi-structured questionnaire, detailed personal discussions and open interview techniques. For each plant, information about all the possible medicinal uses including vernacular names was recorded from local people through individual and face-to-face interviews. During the interviews, informants were always asked to show the reported plants. Prior informed consent was always obtained verbally before conducting interviews and researchers adhered to the ethical guidelines of American Anthropological Association [12] and the International Society of Ethnobiology [13].

At the end of the interviews, information about medicinal weeds and its usage was carefully recorded. The weed species cited during interviews were collected, verified by our interviewees, were collected in polythene bags and taken into for identification. Determination of the species was carried out using adequate botanical literature [14]-[19].

## 3. RESULTAS AND DISCUSSION

The results of the study are presented in Table 1, where plants are arranged in alphabetical order by genus. For each weed species, the botanical name, family, vernacular names, English name and therapeutics uses are reported. In this study a total of 40 weed species distributed in 37 genera belonging to 23 families were reported to be medicinal.

The analysis of the taxonomic structure of the weeds established that the family *Asteraceae* is represented by highest number of species (9 species). *Plantaginaceae* is represented by four species and *Fabaceae* by three species. These are followed by *Apiaceae*, *Brassicaceae*, *Malvaceae*, *Papaveraceae*, *Poaceae* and *Solanaceae*, each represented by two species. The rest of the families (12 families) are represented by one species each. Three species from genus *Trifolium*, two from genus *Plantago* are reported and thirty five genera are with single species. This may be a reflection of some important chemicals present in these families and consequently the need for phytochemical analysis.

Observation indicated that weed species from crop fields are being used to cure different human diseases. The weeds are used for the treatment of different gastrointestinal disorders and respiratory disorders, for the treatment of urogenital system illnesses, inflammatory processes and formation of stone in the kidneys. Most of the species are used as anti-inflammatory, antipyretic, antihepatotoxic, antidiabetic and anti-diarrhoeal, for hepatic disorders, skin diseases, hemorrhoids, hypertension, wound healing, for eye diseases and oral cavity inflammations as well as diuretic and as cholesterol reducer, fever.

Table: 1 List of medicinally weed flora present in the agro-ecosystem of Rahovec region

Botanical name	Family	Vernacular name	English name	Therapeutics
<i>Achilea millefolium L.</i>	Asteraceae	Barëpezmi	Yarrow	Stomach disorders, anti-diarrheal, nausea/vomiting, digestive troubles, stomach pain, hepatic disorders, anti-diabetic
<i>Alchemilla vulgaris</i> agg.	Rosaceae	Alkemilë	Lady's Mantle	Hypertension, blood cleansing, improve fertility in women
<i>Althaea officinalis L.</i>	Malvaceae	Mëllaga bardhë	White mallow	To treat lung disorders, oral cavity antiseptic, anti-tussive/ expectorant.
<i>Arctium lappa L.</i>	Asteraceae	Rrodhe	Common burdock	Headache, fever, gastrointestinal disorders, bronchitis, lithontriptic
<i>Aristolochia clematitis L.</i>	Aristolochiaceae	Kungulli i egër	Birthwort	Anti-haemorrhoidal, eczemas, infected wounds, ulcers
<i>Artemisia vulgaris L.</i>	Asteraceae	Pelini i rëndomtë	Common wormwood	Stomachache, anti-diabetic, anti-parasitic, relaxant
<i>Capsella bursa pastoris (L.) Med.</i>	Brassicaceae	Shtrepër	Shepherd's purse	Anticoagulant, anti-tussive, fever, eczemas, hypertension
<i>Centaurea cyanus L.</i>	Asteraceae	Kokoçel i kaltër	Cornflower	Eye infections, respiratory disorders
<i>Centaureum erythraea Rafn</i>	Gentianaceae	Bar ethesh, kiçica	Common centaury	Fever, anti-pyretic, stomach disorders, digestive discomforts, diarrhea, urinary system infections, anti-haemorrhoidal, lithontriptic
<i>Cichorium intybus L.</i>	Asteraceae	Çikorja	Common chicory	Hepatic disorders, hart disorders, atherosclerosis, anti-diarrhoeal, bronchitis, urinary system infections, anti-haemorrhoidal
<i>Cirsium arvense (L.) Scop.</i>	Asteraceae	Gjemb i arave	Perennial thistle	Hemorrhoids
<i>Convolvulus arvensis L.</i>	Convolvulaceae	Dredhje arash	Field bindweed	Purgative, bronchitis, hypertension, strengthening of immunity
<i>Cuscuta campestris (L.) Nath.</i>	Cuscutaceae	Bar pa rrënjë	Common dodder	Stomachache, intestinal worms
<i>Cynodon dactylon (L.) Pers.</i>	Poaceae	Grami, magari	Bermuda grass	Urinary troubles, anti-haemorrhoidal, hypertension
<i>Datura stramonium L.</i>	Solanaceae	Tatull	Jimsonweed	Antispasmodic, bronchitis, insanity
<i>Daucus carota L.</i>	Apiaceae	Karotë e egër	Wild carrot	Gastric ulcers, dysentery
<i>Elymus repens (L.) Goud.</i>	Poaceae	Krisje, pirrovina	Couch grass	Anti-rheumatic, anti-anaemic, stomach and hepatic disorders, lithontriptic
<i>Equisetum arvense L.</i>	Equisetaceae	Këputja arave	Horsetail	Hepatic disorders, urinary system infections, diuretic, prostatitis lithontriptic
<i>Euphorbia cyparissias L.</i>	Euphorbiaceae	Bima lythave	Cypress spurge	Warts
<i>Fumaria officinalis L.</i>	Papaveraceae	Fom mjekësor	Common fumitory	Dyspepsia, eczemas, laxative, wounds, diuretic, relaxant, anti-hypertensive
<i>Galium aparine L.</i>	Rubiaceae	Ngjitës rrodhe		Kidney disorders, urinary troubles
<i>Linaria vulgaris Müll</i>	Plantaginaceae	Gjineshtra, linarë rëndomtë	Common toadflax	Urinary system inflammations, constipation
<i>Malva sylvestris L.</i>	Malvaceae	Mëllagë	Common mallow	Anti-tussive, bronchitis, antimicrobial, mucolithic
<i>Matricaria chamomilla L.</i>	Asteraceae	Kamomili	Chamomile	Fever, cough, anti-bacterial, digestive, wound healing, diarrhea, stomachaches (esp. those affecting children), eye inflammations, oral cavity inflammations, urinary system infection, recreational/panacea
<i>Orlaya grandiflora (L.) Hoffm.</i>	Apiaceae	Torilis, orlajë lule madhe	White lace flower	Constipation
<i>Papaver rhoeas L.</i>	Papaveraceae	Lulëkuqja	Red poppy	Insomnia, antitussive

<i>Plantago lanceolata</i> L.	Plantaginaceae	Gjethedelli	Narrow leaf plantain	Stomachaches, skin inflammations, nail infection
<i>Plantago major</i> L.	Plantaginaceae	Gjethedell i madh	Common plantain	Stomach troubles, cough, skin diseases, wound healing, urogenital infections
<i>Polygonum aviculare</i> L.	Polygonaceae	Bar pate	Common knotgrass	Urinary system disorders, eczemas
<i>Portulaca oleracea</i> L.	Portulacaceae	Burdullak	Common purslane	Cardio vascular diseases, cholesterol reducer, fever, diarrhoea, diabetes, headache, ulcers, urinary disorders, wounds
<i>Sinapis arvensis</i> L.	Brassicaceae	Sinap i arave	Charlock mustard	Antiparalytic
<i>Solanum nigrum</i> L.	Solanaceae	Solane e zezë	Black nightshade	Skin infection, wounds infection, ulcers, absese.
<i>Sonchus oleraceus</i> L.	Asteraceae	Çiçajë	Sow thistle	Earache, eye diseases, fever, scars, dyspepsia
<i>Stachys palustris</i> L.	Lamiaceae	Sarushë kënetash	Marsh woundwort	Antispasmodic, antiseptic, skin infection
<i>Symphytum officinale</i> L.	Boraginaceae	Kufilmë mjekësore	Common comfrey	Laxative, rheumatism, wounds healing
<i>Taraxacum officinale</i> Web.	Asteraceae	Luleshurdhë mjekësore	Dandelion	Improve blood circulation, blood cleansing, digestive tract disorders, diuretic, urinary system inflammations, lung disorders, bronchitis
<i>Trifolium arvense</i> L.	Fabaceae	Trifili arash	Hare's foot clover	Anti-rheumatic
<i>Trifolium pratense</i> L.	Fabaceae	Trifil i kuq	Red clover	Oral cavity antiseptic, anti-rheumatic, antitussive, stomach disorders
<i>Trifolium repens</i> L.	Fabaceae	Trifil zvarritës	White clover	To stop bleeding, cardio vascular diseases, anti-diarrhoeal
<i>Veronica officinalis</i> L.	Plantaginaceae	Veronica mjekësore	Heath speedwell	Anticoagulant, wound healing, stomachache

A number of species is traditionally used for treatment of cardio vascular diseases and to improve blood circulation, as well as for the treatment of skin conditions, wounds, and diseases of nervous system, liver and anti-fever. Plant of cypress spurge is used for treatment of warts.

The overall results suggest that weed plants are used by the local peoples for their household remedies and for treating various health problems. So, scientific community should attain more attention for *ethnomedicinal* importance of *weeds* and also for documentation and conservation of the traditional ethnomedicinal knowledge of local biological resources.

#### 4. CONCLUSIONS

The study that we conducted in Rahovec region – Kosovo, focused only on species that are common weeds in agro-ecosystems, showed a significant level of traditional knowledge concerning the medicinal use of spontaneous flora for the treatment of many health disorders. The knowledge of medicinal plants is transferred from one generation to another verbally and through experience. Now the younger generations are less interested in agricultural activities and do not popular with traditional practices. Furthermore, due to modern cultural changes and advancement in every field of life style, the use of weeds for medicinal purposes is decreasing.

It is well known that weeds grown in crop fields and vineyards have negative value and people are not aware for medical value of weeds, but if they are grown properly, they can be useful for the farmers. This study shows that the Rahoves region is a rich area for in-depth investigations on ethnobotanical studies, which are missing at the moment. The information about these commonly used weed species must be recorded, preserved and documented before it is lost forever.

#### REFERENCES

- [1]. Kelton, J. A., Price, A. J., "Weed science and management". In: Soils, plant growth and crop production. Vol. III. Edited by Willy H. Verheyne., 2005.
- [2]. Zimdahl R. L., "Fundamentals of Weed Science". Third edition, Academic Press, San Diego, CA. 2007.
- [3]. Stepp, J. R., "The role of weeds as sources of pharmaceuticals". Journal of Ethnopharmacology 92, p. 163–166, 2004.
- [4]. Immanuel, R. R., Elizabeth, L. L., "Weeds in agroecosystems: A source of medicines for human healthcare". International Journal of PharmTech Research, Vol.1, No.2, p. 375-385, 2009.
- [5]. Dajic, S. Z., Janackovic, P., Stankovic, M., "Are there still neglected medicinal plants beyond official and traditional consideration?". Proceedings of the 8th CMAPSEEC. May 19-22, Durrës, Albania, p. 13- 22, 2014.
- [6]. Chakraborty, N. R., Duary, B., "Utilization of Some weeds as Medicine by the Local People in Birbhum District of West Bengal, India". International Journal of Bio-resource and Stress Management, 5(1), p.148-152, 2014.
- [7]. Stepp, J. R., Moerman, D. E., "The importance of Weeds in ethnopharmacology". Journal of Ethnopharmacology 75, p. 19–23, 2001.

- [8]. Rex, I. M., Lyla, E. L., "Weeds in Agroecosystems: A Source of Medicines for Human Healthcare". *Int J of PharmTech Res*, 1, 375-385, 2009.
- [9]. Monaco, TJ, Weller, SC, Ashton, FM, "Weed science – Principles and practices". Fourth edition. John Wiley & Sons, Inc., New York, 2002.
- [10]. Mehmeti, A., Sherifi, E., Demaj, A., Waldhardt, R, "Weed atlas". Titanic, Prishtina, 2015.
- [11]. Mehmeti, A, "Arable weed vegetation and germination traits of frequent weeds in Kosovo". Doctoral dissertation, Agricultural Sciences, Nutritional Sciences and Environmental Management Justus-Liebig University Giessen, 2009.
- [12]. American Anthropological Association (AAA). Statement on Ethics: Principles of Professional Responsibility. <http://www.aaanet.org/profdev/ethics/upload/Statement-on-Ethics-Principles-of-Professional-Responsibility.pdf>.
- [13]. ISE, "The ISE Code of Ethics", 2008.
- [14]. Demiri, M, "Flora ekskursioniste e Shqipërisë", Shtëpia Bot. Libri Shkollor, Tiranë, 1983.
- [15]. Papparisto, K., Demiri, M., Mitrush, I., Qosja, Xh, "Flora e Shqipërisë", Tiranë, 1988.
- [16]. Papparisto, K., Demiri, M., Mitrush, I., Qosja, Xh., Vangjeli, J, "Flora e Shqipërisë 2", Tiranë, 1992.
- [17]. Qosja, Xh., Papparisto, K., Demiri, M., Vangjeli, J., Ruci, B, "Flora e Shqipërisë 3", Tiranë, 1996.
- [18]. Vangjeli J., Ruci B., Mullaj A., Papparisto K., Qosja, X, "Flora e Shqipërisë 4", Tiranë, 2000.
- [19]. Berisha, B., Rexhepi, F., Mala, Xh, Millaku, F, "Atlas i bimëve të Kosovës". Siptint, Prizren, 2012.

# Evolution of Phenological and Pomological Characters of Some Almond Genotypes and Cultivars in Turkey

Hasan Pinar<sup>1</sup>, Mustafa Bircan<sup>2</sup>, Aydin Uzun<sup>3</sup>, Omer Faruk Coskun<sup>4</sup>, Mehmet Yaman<sup>5</sup>

---

## Abstract

Almond is important fruit for Turkey and also other countries which have temperate climate zone. Addition it has grown suitable soil and climate conditions, it is important terms of evaluation of uneven plantations for production and unsuitable soil and drought conditions that used low input. Recently, high demand has occurred for almond fruit because of high nutritional values through the world and also new cultivars aside from current cultivars. Adaptations of almond cultivars have varied as climate conditions. Therefore, it should set up new almond orchard for suitable almond cultivars which have high adaptation ability. In this study, it observed some phenological parameters using 68 almond genotypes. As results, it were determined important variations among almond genotypes with swelling of buds, bud burst, pink bud, early blooming, full blooming, end of blooming and foliation. Obtained results showed that especially, selected almond genotypes can use for breeding programs and orchard set up.

**Keywords:** Almond, phenology

---

## 1. INTRODUCTION

Native land of almond is West and Central Asia [1]. This fruit species that has gained importance for mostly fruits have shown a natural spread in Iran, India and Pakistan and over time have spread the Mediterranean region from these countries [1-2]. This fruit species is one of the most important types of nuts which adapted to the climatic conditions of our country [3].

Turkey is one of the native land of almond such as most fruit species. Almond which is easily can grow almost anywhere in Anatolia is grown the majority of temperate climate zone in the world [4-5-6]. Turkey's almond production is 55,000 tons and it take place in the first row the Aegean region in production and it is followed by the Mediterranean region with about 15,000 tons of almond production. In Mediterranean region, Mersin province has an important place in the production [7].

In the conservation and evaluation of existing plant genetic resources, breeding of the species is of paramount importance. Especially in recent years, many studies have been conducted on their patenting, mapping of strategic genes by agronomic/molecular identification, taking under protection and collection of plant genetic resources in the world. In this respect, since Turkey is an extremely important genetic variation in almond species, gathering, selecting and conservation of genetic resources, the transformation of economic benefits will be extremely important. Turkey is located very rich a location in terms of natural almond population. The presence of superior quality genotypes and suitable for breeding propose within this population will be provide benefits to develop new varieties. All of them will provide extremely advantages for fruit production and economy of Turkey.

In this study aimed to evaluation phenological of some almond genotypes/cultivars obtained some of them by selection breeding previously.

## 2. MATERIALS AND METHODS

---

<sup>1</sup>Corresponding author: Assist. Prof. Erciyes University, Faculty of Agriculture, Department of Horticulture 38039, Melikgazi/Kayseri, Turkey. [hpinarka@yahoo.com](mailto:hpinarka@yahoo.com)

<sup>2</sup>Agr. Eng. Alata Horticulture Researching Institute 33000, Erdemli/Mersin, Turkey. [mustafabircan@tarim.gov.tr](mailto:mustafabircan@tarim.gov.tr)

<sup>3</sup>Phd Student Erciyes University, Faculty of Agriculture, Department of Horticulture, 38039, Melikgazi/Kayseri, Turkey. [ofcoskun1@hotmail.com](mailto:ofcoskun1@hotmail.com)

<sup>4</sup>Res. Ass. Erciyes University, Faculty of Agriculture, Department of Horticulture, 38039, Melikgazi/Kayseri, Turkey. [mehmetyaman@erciyes.edu.tr](mailto:mehmetyaman@erciyes.edu.tr)

<sup>5</sup>Assoc. Prof. Erciyes University, Faculty of Agriculture, Department of Horticulture, 38039, Melikgazi/Kayseri, Turkey. [uzun38s@yahoo.com](mailto:uzun38s@yahoo.com)

Sixty-eight almond varieties and their types were used which planted at Alata Horticultural Research Institute Almond Genetic Resources Parcel-Mersin-Turkey. Phenological observations were recorded such as swelling of buds, bud burst, pink bud, early blooming, full blooming, end of blooming and foliation in 2012.

### 3. RESULTS AND DISCUSSION

Almond is harvested after the harvest maturity and is considered to be inside almonds. On the other hand, it find buyers at a high price almonds known as “Çağla” and obtained from early varieties in early spring. Especially, it has gained importance at places where produced early fruits such as some part of Mediterranean region. In this study, 68 almond genotypes/cultivars which grown at Alata Horticulture Research Institute Genetic Resources parcel in 2012. Bud swelling, bud burst, pink bud, first blooming, full blooming, end of blooming and foliation of almond genotypes were recorded. While the latest bud swelling was at 2/5 genotype (09 February 2012), the earliest bud swelling was 1/2 genotype (05 January 2012). The latest bud burst was at 4202 and 2/5 (13 February 2012). Same results were obtained from same genotypes with regard to ping bud, first blooming and full blooming dates. The earliest end of blooming was at 1/5 numbered genotypes (29 January 2012) and the latest blooming was from 4202 numbered genotypes (20 March 2012). First foliation was similar among same genotypes (Table 1.)

Table 1. Phenological Characteristics of Some Almond Genotypes and Cultivars

	Genotype/Cultivar	Bud swelling	Bud burst	Pink bud	First blooming	Full blooming	End of Blooming	Foliation
1	Drake	18.01.2012	23.01.2012	05.02.2012	08.02.2012	16.02.2012	24.02.2012	18.02.2012
2	101/13	18.01.2012	23.01.2012	14.02.2012	20.02.2012	26.02.2012	01.03.2012	26.02.2012
3	48/6	14.01.2012	19.01.2012	06.02.2012	11.02.2012	16.02.2012	25.02.2012	22.02.2012
4	Teksas	14.01.2012	19.01.2012	06.02.2012	11.02.2012	16.02.2012	25.02.2012	22.02.2012
5	Tuano	15.01.2012	23.01.2012	29.01.2012	06.02.2012	16.02.2012	25.02.2012	22.02.2012
6	Peerles	14.01.2012	19.01.2012	10.02.2012	15.02.2012	22.02.2012	01.03.2012	29.02.2012
7	Cristomorto	29.01.2012	03.02.2012	17.02.2012	22.02.2012	28.02.2012	08.03.2012	01.03.2012
8	Şekerci	19.01.2012	23.01.2012	01.02.2012	06.02.2012	14.02.2012	01.03.2012	26.02.2012
9	48/1	03.02.2012	06.02.2012	13.02.2012	18.02.2012	26.02.2012	06.03.2012	28.02.2012
10	Davey	14.01.2012	19.01.2012	06.02.2012	14.02.2012	22.02.2012	01.03.2012	28.02.2012
11	Nonpareli	24.01.2012	29.01.2012	12.02.2012	18.02.2012	25.02.2012	03.03.2012	28.02.2012
12	Marcona	20.01.2012	27.01.2012	10.02.2012	16.02.2012	24.02.2012	29.02.2012	24.02.2012
13	Ferradue	23.01.2012	29.01.2012	10.02.2012	16.02.2012	24.02.2012	01.03.2012	28.02.2012
14	Papuc	12.01.2012	19.01.2012	29.01.2012	06.02.2012	13.02.2012	20.02.2012	18.02.2012
15	Picantili	15.01.2012	23.01.2012	10.02.2012	18.02.2012	26.02.2012	01.03.2012	26.02.2012
16	Yaltinski	15.01.2012	23.01.2012	10.02.2012	18.02.2012	26.02.2012	01.03.2012	26.02.2012
17	5/1	19.01.2012	23.01.2012	13.02.2012	20.02.2012	28.02.2012	03.03.2012	28.02.2012
18	48/2 (Akbadem)	17.01.2012	23.01.2012	10.02.2012	14.02.2012	18.02.2012	26.02.2012	20.02.2012
19	48/4	20.01.2012	28.01.2012	14.02.2012	20.02.2012	28.02.2012	10.03.2012	06.03.2012
20	48/5	20.01.2012	28.01.2012	14.02.2012	20.02.2012	28.02.2012	10.03.2012	06.03.2012
21	48/9	14.01.2012	20.01.2012	06.02.2012	14.02.2012	24.02.2012	03.03.2012	28.02.2012
22	Gülcan II	14.01.2012	20.01.2012	06.02.2012	14.02.2012	24.02.2012	03.03.2012	28.02.2012
23	Dokuzoğuz II	14.01.2012	18.01.2012	02.02.2012	10.02.2012	16.02.2012	22.02.2012	20.02.2012
24	47/2	06.02.2012	13.02.2012	26.02.2012	01.03.2012	13.03.2012	20.03.2012	16.03.2012

25	7/21	20.01.2012	26.01.2012	06.02.2012	10.02.2012	20.02.2012	28.02.2012	20.02.2012
26	101/9	23.01.2012	29.01.2012	10.02.2012	16.02.2012	24.02.2012	01.03.2012	28.02.2012
27	106/1	03.02.2012	06.02.2012	13.02.2012	18.02.2012	26.02.2012	06.03.2012	28.02.2012
28	17/4	23.01.2012	29.01.2012	10.02.2012	16.02.2012	24.02.2012	01.03.2012	28.02.2012
29	7/22	14.01.2012	19.01.2012	06.02.2012	14.02.2012	22.02.2012	01.03.2012	28.02.2012
30	4202	06.02.2012	13.02.2012	26.02.2012	01.03.2012	13.03.2012	20.03.2012	16.03.2012
31	4227	14.01.2012	19.01.2012	06.02.2012	14.02.2012	22.02.2012	01.03.2012	28.02.2012
32	21/3	24.01.2012	28.01.2012	06.02.2012	13.02.2012	20.02.2012	26.02.2012	03.03.2012
33	4214	24.01.2012	28.01.2012	06.02.2012	13.02.2012	20.02.2012	26.02.2012	03.03.2012
34	21/9	14.01.2012	19.01.2012	06.02.2012	14.02.2012	22.02.2012	01.03.2012	28.02.2012
35	612	14.01.2012	18.01.2012	02.02.2012	10.02.2012	16.02.2012	22.02.2012	20.02.2012
36	5009	14.02.2011	18.02.2011	24.02.2011	26.02.2011	03.03.2011	10.03.2011	28.03.2011
37	5007	14.01.2012	19.01.2012	06.02.2012	11.02.2012	16.02.2012	25.02.2012	22.02.2012
38	1/4	12.01.2012	15.01.2012	24.01.2012	28.01.2012	02.02.2012	10.02.2012	02.02.2012
39	1/5	12.01.2012	15.01.2012	24.01.2012	28.01.2012	02.02.2012	10.02.2012	02.02.2012
40	1/8	19.01.2012	23.01.2012	02.02.2012	06.02.2012	14.02.2012	22.02.2012	18.02.2012
41	1/9	19.01.2012	23.01.2012	02.02.2012	06.02.2012	14.02.2012	22.02.2012	18.02.2012
42	1/10	19.01.2012	23.01.2012	04.02.2012	13.02.2012	20.02.2012	28.02.2012	26.02.2012
43	1/12	14.01.2012	19.01.2012	08.02.2012	14.02.2012	24.02.2012	29.02.2012	26.02.2012
44	1/13	19.01.2012	23.01.2012	04.02.2012	13.02.2012	20.02.2012	28.02.2012	26.02.2012
45	1/15	14.01.2012	19.01.2012	29.01.2012	05.02.2012	13.02.2012	20.02.2012	15.02.2012
46	2/3	14.01.2012	19.01.2012	08.02.2012	14.02.2012	24.02.2012	29.02.2012	26.02.2012
47	1/5	05.01.2012	10.01.2012	16.01.2012	20.01.2012	25.01.2012	29.01.2012	20.01.2012
48	2/7	14.01.2012	19.01.2012	29.01.2012	06.02.2012	13.02.2012	20.02.2012	18.02.2012
49	2/8	14.01.2012	19.01.2012	29.01.2012	06.02.2012	13.02.2012	20.02.2012	18.02.2012
50	2/10	14.01.2012	19.01.2012	29.01.2012	05.02.2012	13.02.2012	20.02.2012	15.02.2012
51	3/5	05.01.2012	10.01.2012	16.01.2012	20.01.2012	25.01.2012	29.01.2012	20.01.2012
52	3/6	15.01.2012	19.01.2012	06.02.2012	13.02.2012	20.02.2012	28.02.2012	26.02.2012
53	3/9	19.01.2012	23.01.2012	04.02.2012	10.02.2012	13.02.2012	18.02.2012	24.02.2012
54	4/2	15.01.2012	19.01.2012	29.01.2012	03.02.2012	13.02.2012	20.02.2012	18.02.2012
55	4/5	10.01.2012	14.01.2012	19.01.2012	23.01.2012	03.02.2012	13.02.2012	14.02.2012
56	4/6	15.01.2012	19.01.2012	29.01.2012	03.02.2012	13.02.2012	20.02.2012	18.02.2012
57	4/7	19.01.2012	23.01.2012	04.02.2012	13.02.2012	20.02.2012	28.02.2012	26.02.2012
58	4/9	19.01.2012	23.01.2012	04.02.2012	13.02.2012	20.02.2012	28.02.2012	26.02.2012
59	4/10	14.01.2012	19.01.2012	08.02.2012	14.02.2012	24.02.2012	29.02.2012	26.02.2012
60	4/14	19.01.2012	23.01.2012	04.02.2012	10.02.2012	13.02.2012	18.02.2012	24.02.2012
61	2/5	09.02.2012	13.02.2012	24.01.2012	28.02.2012	03.03.2012	10.03.2012	08.03.2012
62	5/4	10.01.2012	14.01.2012	19.01.2012	23.01.2012	03.02.2012	13.02.2012	14.02.2012
63	5/5	10.01.2012	14.01.2012	19.01.2012	23.01.2012	03.02.2012	13.02.2012	14.02.2012
64	5/6	14.01.2012	19.01.2012	29.01.2012	05.02.2012	13.02.2012	20.02.2012	15.02.2012

65	5/9	19.01.2012	23.01.2012	04.02.2012	13.02.2012	20.02.2012	28.02.2012	26.02.2012
66	5/11	19.01.2012	23.01.2012	04.02.2012	10.02.2012	13.02.2012	18.02.2012	24.02.2012
67	5/14	15.01.2012	19.01.2012	06.02.2012	13.02.2012	20.02.2012	28.02.2012	26.02.2012
68	5/15	14.01.2012	19.01.2012	08.02.2012	14.02.2012	24.02.2012	29.02.2012	26.02.2012

Almond (*Prunus dulcis* (Mill.)) is one of the oldest cultivated nut trees in the world. This fruit tree is a species which is commercially grown worldwide [8]. Same wild almond species provide suitable characteristics such as self-fertility and resistance to drought, salinity and low winter temperatures and resistance to abiotic and biotic stresses [9-10- 8]. It is usually living on dry calcareous soils and has been used as a grafting rootstock for domesticated almonds [11].

Conducted a study using Cristomorto, Ferrastar, Nonpareil, Tuono, Ferragnes, Picantili, Yaltinski, Garrigues cultivars which late flowering cultivars in Yalova-Turkey and the earliest blooming observed at Cristomorto and the latest blooming observed from Yaltinski cultivars[12]. It was observed the earliest blooming with Fellamasa, Fascinello and Pizzuta d'Avola cultivars and the latest blooming were observed with Lauranne and Glorieta cultivars in island of Sardinia [13]. Also, Researchers compared 20 almond genotypes with regard to growth, beginning of fruit, yield and quality criteria in Gaziantep-Turkey conditions [14]. They observed that while the earliest blooming genotypes were 48-5 and 101-13, the latest blooming genotypes was Ferraduel' de. Results of some researches on almond showed that there are big variation among cultivars/genotypes and locations where grown almond cultivars.

#### 4. CONCLUSIONS

Obtained results with this study showed that there are important variation among almond genotypes and cultivars which used 68 almond genotypes with regard to phenological features. Especially, 1/5 and 1/5 numbered genotypes seems appropriate with regard to evaluation for fresh consumption due to its earliness properties. Moreover, it can be start new breeding programs using the features of these the genotype.

#### REFERENCES

- [1] Küden, A.B., Küden, A., 2000. Badem Yetiştiriciliği. TÜBİTAK TARP Yayınları. 18 s.
- [2] Rugini, E., Monastr, F., 2003. Temperate Fruits. In S.K. Mitra, D.S. Rathora and T.K. Bose (Eds), Display Printers (P) LTD. India, ISBN 81-900171-1-X, Volume II, 344-414.
- [3] Çağlar, S., Güngör, M.K., Küden, A., Kaşka, N., 1995. Badem Yetiştiriciliğinde Saçak Köklü Çoğur ve Fidan Eldesi Üzerinde Araştırmalar. Türkiye II. Ulusal Bahçe Bitkileri Kongresi. Çukurova Üniversitesi Ziraat Fakültesi Bahçe Bitkileri Bölümü.3-6 Ekim 1995. Cilt: 1, 384-388.
- [4] Beyhan, Ö. ve Bostan, S.Z. 1995. Darenden Bademlerinin (*P. amygdalus* L.) Seleksiyon Yolu ile Islahı Üzerine Bir Araştırma. Kahramanmaraş Sütçü İmam Üniversitesi Fen Bilimleri Enstitüsü Dergisi 1 (1), Kahramanmaraş.
- [5] Beyhan, Ö. ve Şimşek, M. 2007. Kahramanmaraş Merkez İlçe Bademlerinin (*Prunus amygdalus* L.) Seleksiyon Yoluyla Islahı Üzerinde Bir Araştırma. BAHÇE 36 (1-2); 11-18. Yalova, 11-18.
- [6] Dokuzoğuz, M., Gülcan, R., 1973. Ege Bölgesi Bademlerinin Seleksiyon Yoluyla Islahı ve Seçilmiş Tiplerin Adaptasyonu Üzerine Araştırmalar. TÜBİTAK, No:22.
- [7] TUIK(Turkish Statistical Institute), 2014,
- [8] Madam, B., Rahemi, M., Mousavi, A., Martínez-Gómez, P., 2011. Evaluation of the behavior of native Iranian almond species as rootstocks. Int. J. Nuts Relat. Sci. 2, 29–34.
- [9] Denisov, V.P., 1980. Drought resistance of some almond species in Turkmenistan. Trudy Prikladnot Bot. Genet. Selk. 67, 129–135
- [10] Gradziel, T.M., Martínez-Gómez, P., Dicenta, F., Kester, D.E., 2001. The utilization of *Prunus* species for almond variety improvement. J. Am. Pomol. Soc. 55, 100–108.
- [11] Mozaffarian, V., 1996. Trees and Shrubs of Iran. Farhang Moaser Publisher, Tehran, Iran, pp. 642–664 (in Farsi).
- [12] Akçay, M.E., Tosun, İ. 2005. Bazı geç çiçek açan yabancı badem çeşitlerinin yalova ekolojik koşullarındaki gelişme ve verim davranışları. Atatürk Üniversitesi Ziraat Fakültesi Dergisi, 36 (1): 1-5.
- [13] Lovicu, G., Pala, M., De Pau, L., Satta, D., Farci, M. 2002. Bioagronomical behaviour of some almond cultivars in Sardinia. Acta Horticulturae, 591: 487-491.
- [14] Atlı, H.S., Acar, İ., Arpacı, S., Akgün, A., Aydın, Y ve Bilim, C., 2005. Yerli ve yabancı değişik badem çeşitlerinin GAP bölgesi sulu koşullarında gelişme, meyveye yatma, verim ve bazı kalite değerlerinin karşılaştırılması GAP IV. Tarım Kongresi, 21-23 Eylül, Şanlıurfa.



# A Three-Dimensional model of single PEM fuel cell having Triple-Serpentine flow channel developed with CFD

Elif Eker Kahveci<sup>1</sup>, Imdat Taymaz<sup>2</sup>

---

## Abstract

In this investigation, a three dimensional, single-phase proton exchange membrane (PEM) fuel cells with triple-serpentine flow channel was studied numerically, evaluating reactant gas humidification, water management and cell performance. The model equations were solved using CFD software ANSYS Fluent® 16.2 with Gambit® (2.4.6) as a pre-processor. This 3-D model with 19x50 mm<sup>2</sup> active layer used to investigate the performance of fuel cell by determining the current density, oxygen, hydrogen and water molar concentration distributions took into account the mass, momentum, energy, species, charge conservation equation as well as combines electrochemistry reaction inside the fuel cell. The simulation results were illustrated polarization curves including I-V and I-P curves. Various properties of the GDL such as permeability, porosity, tortuosity and the hydrophobic texture can affect the flooding at flow channels. In this study, the effect of GDL porosity on flooding was investigated with different operating conditions. From the results, for lower operating voltages, as the cathode and anode relative humidity increases, the cell performance is enhanced because the cell performance is mainly dependent on the cathode mass transport limitations due to the liquid water blockage effect. As decreases, the oxygen concentration in the reactants increases and the water concentration on the cathode side decreases, this reduces flooding and improves the cell performance. Also, analysing the polarization curve it can be said the performance of the PEM fuel cell was improved by increasing the reactant gases humidification.

**Keywords:** flooding, gas diffusion layer, humidification, PEM fuel cell, performance

---

## 1. INTRODUCTION

Fuel cell is an electrochemical device that continuously changes the chemical energy of a fuel (hydrogen) and oxidant (oxygen or air) directly to electrical energy and heat, without combustion. The proton exchange membrane fuel cell (PEMFC) is considered to be a promising power source, especially for transportation and stationary cogeneration applications due to its high efficiency, low operating temperature, high power density, low emission and low noise. A PEMFC is composed of the catalyst layers, membrane, gas diffusion layers and bipolar plate. The GDL have two major functions. First, the reaction gases can successfully diffuse into the catalyst layer and uniformly spread thereon because of the porous structure of the GDLs. Second, the electrons generated by the anode catalysis are drained from the anode and enter the external circuit. Bipolar plates are designed to accomplish many functions, such as distribute reactants uniformly over the active areas, remove heat from the active areas, carry current from cell to cell and prevent leakage of reactants and coolant.

The performance of a PEMFC is affected by many factors such as temperature, pressure, relative humidity, mass flow rate of feed gases, channel geometries in current collector plate and the characteristics of the membrane, catalyst layer, and gas diffusion layer. In literature, several modelling and experimental work has been investigated in order to understand the effect of channel geometries in bipolar plate including, serpentine flow channels, parallel flow channels, interdigitated flow field, flow field with pins and the influence of these parameters to the fuel cell performance. Because experimental work is costly, numerical modeling becomes an efficient and convenient approach to fuel cell analysis. For the last decade, much effort has been involved in the development of a numerical model. However few studies have been reported on the flow field designs and the bipolar plates in the literature [1–7].

Xing et al. [1] developed a fully coupled 2D, along-the-channel, two-phase flow, non-isothermal, CFD model. In their results thinner GDL could result in more non-uniform and more significant temperature rise at high current densities. Also a new channel design featured with multi-inlets and outlets is proposed to reduce water flooding improve the cell performance.

---

<sup>1</sup>Corresponding author: Sakarya University, Faculty of Engineering, Department of Mechanical Engineering, 54187, Serdivan/Sakarya, Turkey. [eker@sakarya.edu.tr](mailto:eker@sakarya.edu.tr)

<sup>2</sup>Sakarya University, Faculty of Engineering, Department of Mechanical Engineering, 54187, Serdivan/Sakarya, Turkey. [taymaz@sakarya.edu.tr](mailto:taymaz@sakarya.edu.tr)

Sierra et al. [2] in their research a 3D numerical study on a PEM fuel cell model is focused on the performance evaluation of three flow fields with cylindrical geometry (serpentine, interdigitated and straight channels) in a fuel cell. The results showed that the tubular design with the straight channels presented the lowest pressure drop in the flow channels, the interdigitated tubular design had the highest water generation at the cathode, the serpentine design presented the most uniform distributions of hydrogen concentration, temperature and current density on the active area of the cell.

Iranzo et al. [3] presented in this work a validation that was performed by comparing the local liquid water distributions obtained from the CFD model with experimental measurements developed CFD model for a 50 cm<sup>2</sup> PEM fuel cell. Major conclusion of the study was that the CFD model used is not able to reproduce the liquid water accumulated in the channels, clearly observed in the neutron radiographs but not in the CFD results, given the treatment of the multiphase flow model.

Rahimi-Esbo et al. [4] in their paper seven flow fields were analyzed and their performances were investigated at the optimum channel to rib ratio. A novel serpentine flow field design aimed at effective water removal is introduced and examined. The results showed that 2-1-serpentine flow field has the highest performance especially at high current densities. It was found that for operating voltages over 0.5 V, the geometry of the flow channels did not have a significant effect on performance.

Saco et al. [5] carried out a numerical analysis on scaled up model of PEM fuel cell (225 cm<sup>2</sup>) with four flow channel models. The study was mainly conducted to find the impact of flow field design on the performance of PEM fuel cell. From the results it was found that the current and power density of the straight zigzag flow channel was quite high compared to all other flow channels due to better consumption of hydrogen and oxygen molecules, better water removal rate in the flow channels.

Rostami et al. [6] studied a three-dimensional numerical model to understand the effect of bend sizes on a PEM (polymer electrolyte membrane) fuel cell in this work. The obtained results showed that as bend size increases from 1 mm to 1.2 mm, not only did the over potential reduce significantly but temperature gradient was also alleviated. Moreover, it was shown that the serpentine flow channels with 1.2 mm square bend size acted successfully in preventing secondary flows internal thereby decreasing pressure drop about 90.6% compared to serpentine flow channels with a bend size of 0.8 mm.

Vazifeshenas et al. [7] employed a novel compound flow field design concerned in PEM fuel cell to investigate the effectiveness developed with computational fluid dynamics (CFD). A typical serpentine and parallel flow field designs was verified through three dimensional simulations. From the results, the parallel design had the lowest current density and power in comparison with the other designs. Compound design could perform as well as the typical serpentine design, and also in some aspects could be a better choice than the serpentine one.

The goal of this study was to present the effects of various operating factors on the performance of a PEMFC with the most common bipolar plate design that is the triple serpentine flow field in fuel cells. In this design the gas flows through the channels circulating throughout the active area of the fuel cell. The polarization curves of the fuel cell were plotted under similar operating conditions with different GDL porosity.

## 2.ANALYSIS OF MODEL

In this study, the model presented is a three-dimensional, isothermal, single-phase, steady-state model that resolves coupled transport processes in membrane, catalyst layers, gas diffusion layers and reactant flow channels of a PEM fuel cell (Fig.1). Operating conditions and general geometrical properties of the PEM fuel cells components are given at Table 1 and Table 2.

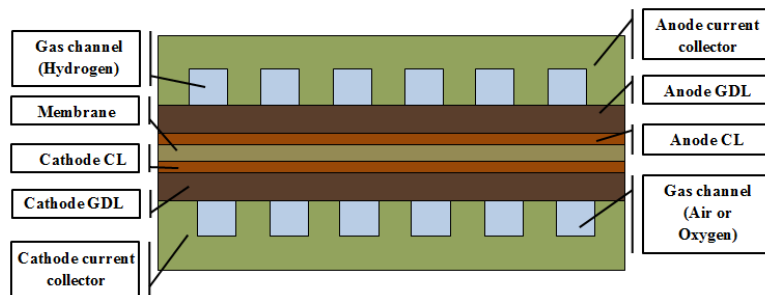

Figure 23. Schematic of the PEM fuel cell Geometry of Model

Table 9. Operating conditions of PEM fuel cell model

Parameters	Units	Value
Operation pressure	kPa	200
Cell temperature	K	343
Cathode stoichiometric ratio	-	2
Anode stoichiometric ratio	-	2
Cathode terminal	V	0.4-0.9

Anode terminal	V	0.0
Cathode mass flow rate	kg/s	calculated
Anode mass flow rate	kg/s	calculated
Cathode RH	-	10%,50%,100%
Anode RH	-	10%,50%,100%

The geometric model is created in Gambit 2.4.6. ANSYS-Fluent 16.2 PEMFC module is used in this research to compile the appropriate user-defined functions for a PEMFC. In this model, the numerical domain is a single-cell geometry domain. Pure hydrogen and air are used as reactant gases in the model. The inlet flow velocity was controlled by stoichiometry numbers of 2 at the anode and 2 at the cathode. The operating pressure was 200 kPa absolute at the exit of the cell. The active surface area is 19x50 mm<sup>2</sup>, with triple-serpentine flow field configuration. The channels are 1 mm in width and 1 mm in depth. The width of the rib is 1 mm. Also the flow channels are shown in Figure 2.



Figure 2. The bipolar plate flow channel pattern

Table 2. General geometrical property of the PEM fuel cells components

Parameters	Units	Value
Channel width	mm	1
Channel length	mm	50
Gas diffusion layer thickness	mm	0.27
Catalyst layer thickness	mm	0.02
Membrane thickness	mm	0.127
Active area	m <sup>2</sup>	0.00095

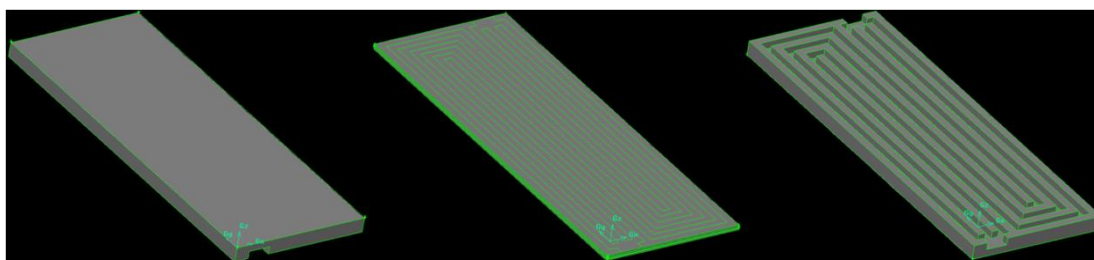

Figure 3.3-D PEM fuel cell solid model created by Gambit2.4.6

## Theoretical Formulation

Basic equations used during fuel cell operation are as follows:

Conservation of mass equation:

$$\nabla \cdot (\rho \vec{u}) = S_m \quad (1)$$

The source terms are;

$$S_m = S_{H_2} + S_{wv} + S_{wl} + S_{awv} \quad (2)$$

$$S_m = S_{O_2} + S_{wv} + S_{wl} + S_{cww} \quad (3)$$

$$S_{H_2} = -\frac{M_{H_2} A_{cv} I}{2F} \quad (4)$$

$$S_{O_2} = -\frac{M_{O_2} A_{cv} I}{4F} \quad (5)$$

Momentum transport equation:

$$\nabla \cdot (\rho \vec{u} \vec{u}) = -\nabla P + \nabla \cdot (\mu \nabla \vec{u}) + S_{p,i} \quad (6)$$

Here  $\beta$  is the permeability.  $S_{p,i}$  is the sink source term for porous media in x, y and z-directions;

$$S_{p,i} = -\left(\sum_{j=1}^3 \frac{1}{\beta_j} \mu u_j\right) \quad (7)$$

Species transport equation:

$$\nabla \cdot (\rho m_n \vec{u}) = \nabla \cdot (J_n) + S_s \quad (8)$$

Here  $n$  denotes for  $H_2$ ,  $O_2$  water vapor and liquid water. The source terms are the same as those of the conservation of mass equation. The diffusion mass flux ( $J$ ) of species  $n$  in  $n$ -direction is:

$$J_{\xi,n} = -\rho D_{\epsilon,n} \frac{\partial m_{\xi,n}}{\partial \xi} \quad (9)$$

Energy equation:

$$\nabla \cdot (\rho \vec{u} h) = \nabla \cdot (k \nabla T) + S_h \quad (10)$$

The source term  $S_h$  can be obtained by energy losses and heat source by phase change. The heat source from the electrochemical reaction:

$$S_{h\epsilon} = h_{rxn} \left[ \frac{I A_{cv}}{2F} \right] - I V_{cell} A_{cv} \quad (11)$$

The local current density of the cell is calculated from the open circuit voltage ( $V_{oc}$ ) and the losses;

$$I = \frac{\sigma_m}{t} \{V_{oc} - V_{cell} - \eta\} \quad (12)$$

Where  $t$  is the membrane thickness and  $\sigma_m$  is the membrane conductivity and defined as;

$$\sigma_m = \left(0.514 \frac{M_{m, dry}}{\rho_{m, dry}} C_{wa} - 0.326\right) \cdot \exp\left(1268 \left(\frac{1}{T_0} - \frac{1}{T}\right)\right) \quad (13)$$

## Numerical Solution

The procedure to model PEM fuel cell is;

1. Creating and defining the geometry of the fuel cell with Gambit 2.4.6
2. Creating an appropriate mesh for geometry with Gambit 2.4.6.
3. Assigning zone names and types that is required in the FLUENT PEM fuel cell add-on module.
4. Importing the mesh file into FLUENT.
5. Defining fuel cell parameters, setting up of the case and then running calculations.
6. Postprocessing the results.

The model equations were solved using the commercial computational fluid dynamics (CFD) software ANSYS Fluent® 16.2 with Gambit® (2.4.6) as a pre-processor. The CFD code has an add-on module for fuel cells, which has the requirement of the

source terms for species transport equations, heat sources, and liquid water formation (ANSYS 2015). A finite volume method was used for solving the problem. The conservation of mass, momentum and energy equations were solved until the iterative process meets the convergence criteria.(Fig.4) The number of iterations was determined as 200. A HP-PC-Intel®Xeon® CPU E5-2650v2@2.6 GHz, 2.6 GHz, 64 GB was used to solve the set of equations.

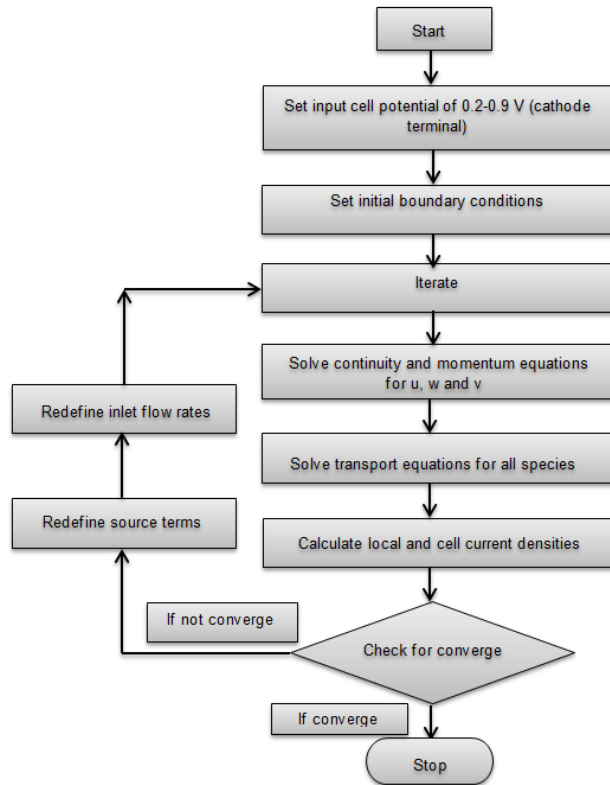

Figure 4. Solution Algorithm

### 3.RESULTS AND DISCUSSION

#### Relative Humidity Effect at Anode Side

In order to reach good cell performance, there must be water balance between anode and cathode. When hydrogen at the anode inlet is fully humidified, the humidity of the membrane can be well maintained. However if hydrogen is insufficiently humidified, membrane dehydration could occur on the anode side. The problem of water deficiency on the anode side of the membrane can be solved by humidification of hydrogen flow at anode side. For each of the gas humidification configurations for the double-serpentine PEMFC model, it was investigated the water accumulation in the membrane operated with constant operating conditions. In Fig. 5 it is shown that I-V and I-P curves anode RH =10%, 50%, 100% respectively. According to the simulated results in figure, as anode relative humidity increase, the overall water uptake in the system increases. This increase enhances the cell performance. Maximum power density was reached at 0.7 V, 1.136 A/cm<sup>2</sup> with the value of 0.4754W/cm<sup>2</sup>.

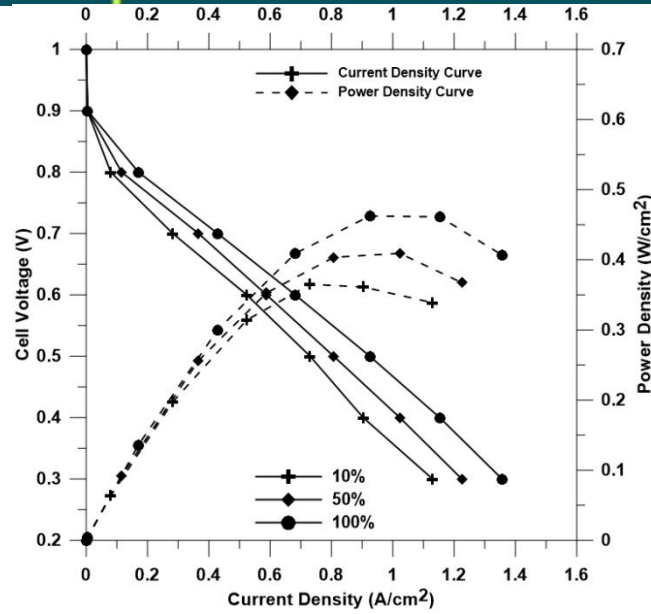

Figure 5. *I-V and I-P curves cathode RH= 100% and anode RH =10%, 50%, 100% respectively*

As mentioned above, the reason for this decrease is that diffusing the oxygen from channel through the GDL in order to occur the electrochemical reaction. As shown in the Fig. 6, it is also noted that the optimal oxygen consumption of the channels was achieved at 100% relative humidity obtained the maximum current and power density to improve the performance of fuel cell.

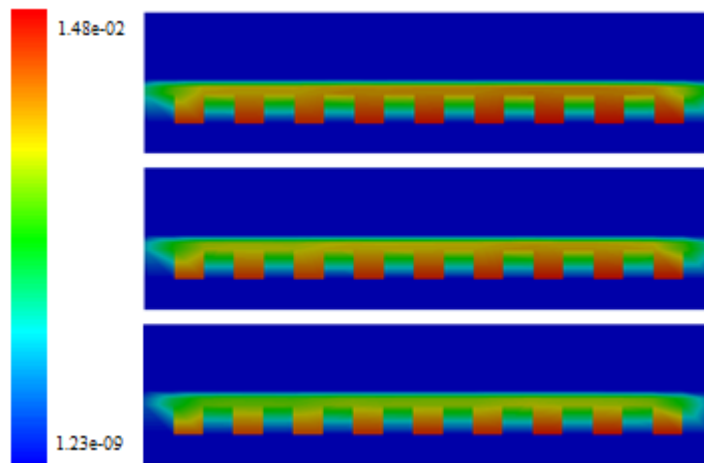

Figure 6. *Contours of oxygen molar concentration distribution ( $\text{kmol/m}^3$ ) in the middle of model with different relative humidity at x-z plane, 0.6V, (a) 10%, (b) 50 %, (c) 100%*

Fig. 7 displays the distribution of the  $\text{H}_2\text{O}$  molar concentration through the membrane domain with different relative humidity. The simulated results showed that water distribution and membrane conductivity in the fuel cell depended on anode humidification and the related water management. The increase of concentration of water at membrane is significant when the relative humidity is increased from 10% to 100%.

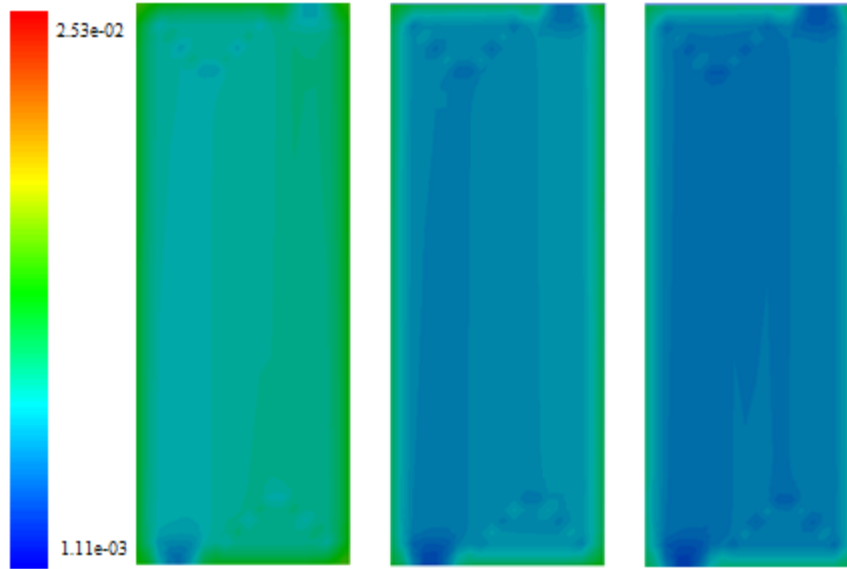

Figure 7. Contours of molar concentration distribution of  $H_2O$  ( $kmol/m^3$ ) in membrane with different relative humidity at  $x$ - $y$  plane, 0.6 V (a) 100%, (b) 50 %, (c) 10%

### Relative Humidity Effect at Cathode Side

The water generated at the cathode must be transported away from the catalyst layer by evaporation, water-vapor diffusion and capillary transport of liquid water through the GDL into the flow channels of the flow field. If this does not occur, excess water exists at the cathode side and condenses. This causes blocking the pores of the GDL and reducing the active sites of the cathode catalyst layer. This phenomenon is known as “flooding”, and is an important limiting factor of PEM fuel cell performance. The extent of flooding and the effects of flooding depend on the operating conditions and the properties of PEM materials like bipolar plates, MEA. In Fig. 8 it is shown that I–V and I–P curves anode RH= 100% and cathode RH =10%, 50%, 100% respectively. However, it is clearly seen from the figure that the current density is increased by the increasing cathode relative humidity.

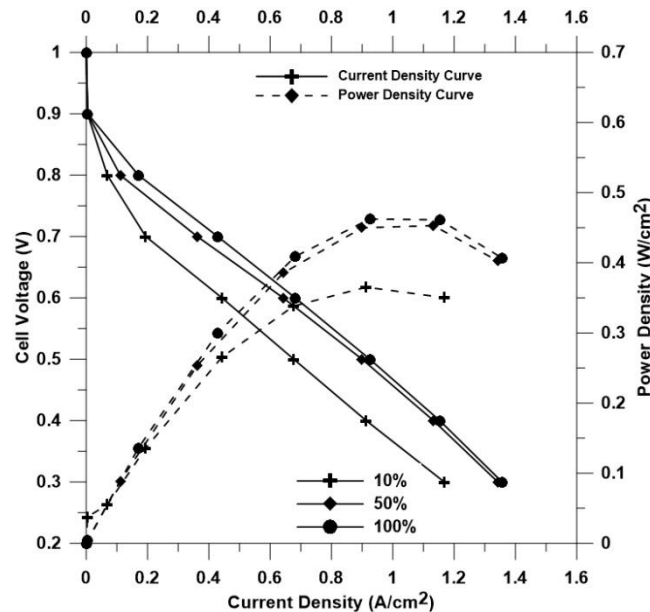

Figure 8. I–V and I–P curves anode RH= 100% and cathode RH =10%, 50%, 100% respectively

### Effect of Cell Voltage on Water Content

The effects of cell voltage on the fuel cell performance have been shown that include the membrane and cathode channel water content of the in Fig.9 and Fig.10 at different cell voltages. It can be seen in both figures the water content increases with increasing the voltage value. After the voltage rises to a certain value, the increase of cathode humidification adversely affect the cell performance due to a decrease in current density. As mentioned above, the reason for this decrease is that much water, because of water production in the electrochemical reaction at the cathode and excessive humidification of the cathode side,

will stay in the porous cathode GDL, preventing the oxygen from diffusing through the GDL to catalyst layer. And this causes flooding at porous sides of fuel cell. Consequently the best performance occurs at 0.6 V.

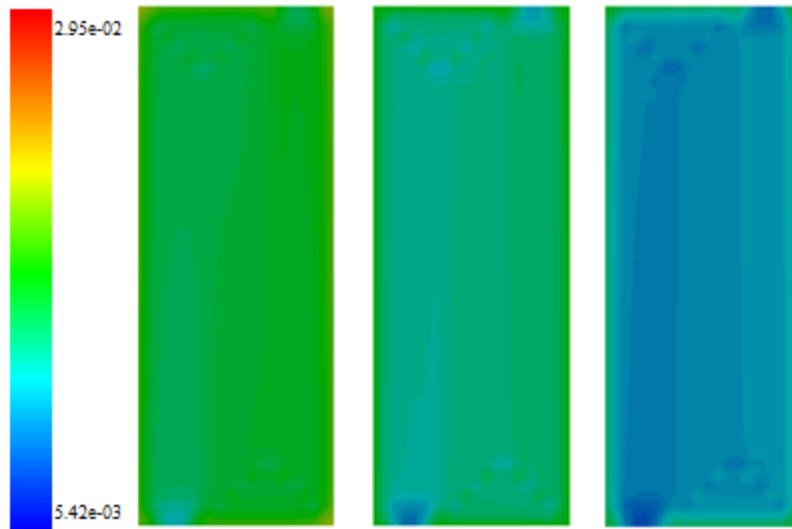

Figure 9. Contours of molar concentration distribution of water ( $\text{kmol/m}^3$ ) in membrane with different cell voltage at x-y plane (a) 0.3V, (b) 0.6V, (c) 0.9V

As the cell voltage decreases, the cell performance is enhanced because the cell performance is mainly dependent on the cathode mass transport limitations due to the liquid water blockage effect. The water concentration in the reactants decreases. This reduces means that the cathode flooding is prevented and it improves the cell performance.

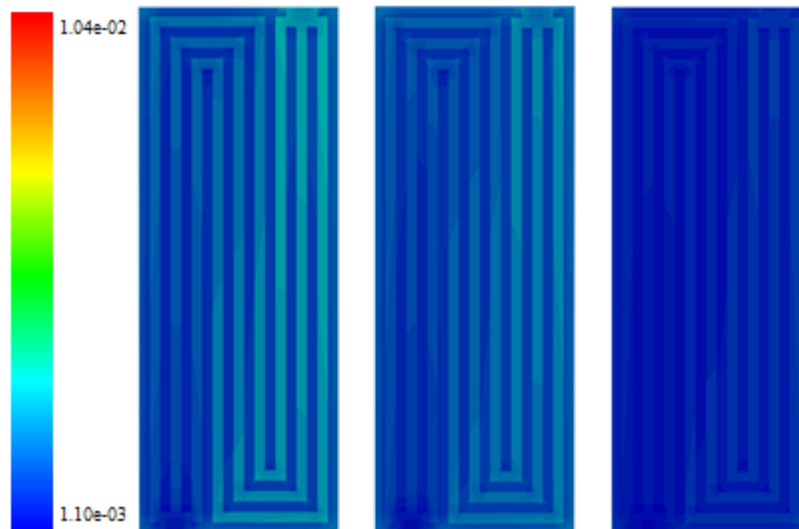

Figure 10. Contours of molar concentration distribution of water ( $\text{kmol/m}^3$ ) in cathode channel with different cell voltage at x-y plane (a) 0.3V, (b) 0.6V, (c) 0.9V

### Effect of GDL Porosity on Current and Power Density

In Figure 11 the I–V curves demonstrate that a better performance can be obtained by using a gas diffusion layer of higher porosity. A gas-diffusion layer of higher porosity has an ability of stronger diffusion transport, which is beneficial in that it supplements the reactant gas to the catalyst layer. Increasing operation temperature is helpful to enhance electrochemical reaction rate and ionic transport in PEMFC, and the cell performance.



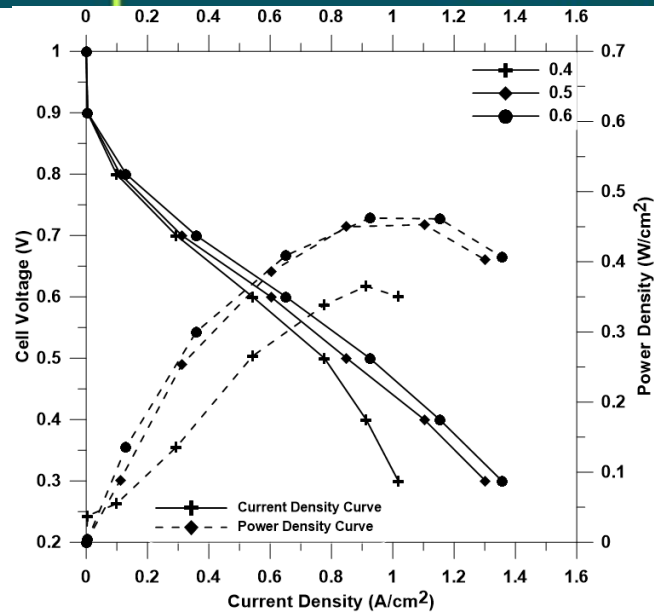

Figure 11. I-V and I-P curves of the effect of GDL porosity on current and power density with  $\epsilon=0.4, 0.5, 0.6$  respectively

## 4.CONCLUSION

A three-dimensional computational fluid dynamics model of a PEM fuel cell with triple-serpentine flow channels was developed to investigate the effects of cell voltage, gas diffusion layer porosity and reactant gases humidification on performance. Using a single-phase, steady-state, three-dimensional model of PEM fuel cell, the following conclusion was obtained; the humidity in the reactant gases is an important factor to consider for improving the cell performance. As the relative humidity of anode side increases, both the chemical reaction and mass transfer of hydrogen are enhanced due to the increase of water content in the membrane, which leads to a better cell performance. The maximum power density for the highest performing was  $0.4754 \text{ W/cm}^2$  and occurred at maximum anode /cathode humidification with 0.6 GDL porosity at 0.6 cell voltage.

## REFERENCES

- [1] L. Xing, Q. Cai, X. Liu, C. Liu, K. Scott and Y. Yan, "Anode partial flooding modelling of proton exchange membrane fuel cells: Optimisation of electrode properties and channel geometries," *Chemical Engineering Science*, vol.146,pp.88–103,Jun. 2016.
- [2] J.M. Sierra, S.J. Figueroa-Ramírez, S.E. Díaz, J. Vargas and P.J. Sebastian, "Numerical evaluation of a PEM fuel cell with conventional flow fields adapted to tubular plates," *International Journal of Hydrogen Energy*, vol.39,pp. 16694–16705,Oct. 2014.
- [3] A.Iranzo, P. Boillat and F. Rosa, "Validation of a three dimensional PEM fuel cell CFD model using local liquid water distributions measured with neutron imaging," *International Journal of Hydrogen Energy*,vol.39,pp. 7089–7099,Apr. 2014.
- [4] M. Rahimi-Esbo, A.A. Ranjbar, A. Ramiar, E. Alizadeh and M. Aghaee, "Improving PEM fuel cell performance and effective water removal by using a novel gas flow field," *International Journal of Hydrogen Energy*,vol.41,pp. 3023–3037,Jan. 2016.
- [5] S. Arun Saco, R. Thundil Karuppa Raj and P. Karthikeyan, "A study on scaled up proton exchange membrane fuel cell with various flow channels for optimizing power output by effective water management using numerical technique," *Energy*,vol.113,pp. 558–573,Oct. 2016.
- [6] L. Rostami, P. M. G. Nejad and A.Vatani, "A numerical investigation of serpentine flow channel with different bend sizes in polymer electrolyte membrane fuel cells," *Energy*, vol.97, pp. 400–410, Feb. 2016.
- [7] Y.Vazifeshenas, K. Sedighi and M. Shakeri, "Numerical investigation of a novel compound flow field for PEMFC performance improvement," *International Journal of Hydrogen Energy*, vol.40, pp. 15032–15039, Nov. 2015.

## BIOGRAPHY



**Elif Eker Kahveci** was born at Sakarya, Turkey on 23 March 1987 and earned BSc in Mechanical Engineering from Selcuk University, Konya, Turkey in 2009. He got the degree of master of Mechanical Engineering at Sakarya University which is located in Sakarya, Turkey in August 2012. She is now enrolled doctorate program in Mechanical Engineering at Sakarya University. She is working as research assistant at Sakarya University. Her research is about investigation of PEM fuel cells performance.



**Imdat Taymaz** was born at Sakarya, Turkey in 1961 and earned BSc in Mechanical Engineering from Istanbul Technical University Istanbul, Turkey in 1983. He got the degree of master of Mechanical Engineering at Istanbul Technical University in 1985 and the degree of doctorate at Sakarya University in 2001. He has interest in the following research areas as internal combustion engines, alternative fuels, fuel cells, engine heat transfer, cogeneration systems. His research is linked to technologies for automotive applications. He is now working as professor at Sakarya University.

# Yield and Quality Effects of Nitrogen Applied at Different Levels and Periods on Sugarbeet

*FatmaGokmen Yilmaz<sup>1</sup>, Sait Gezgin<sup>1</sup>, Mustafa Harmakaya<sup>1</sup>*

---

## Abstract

*In this study, Coyote sugar beet variety was grown at the Konya Sugar Industry and Trade Company Alakova Field Trial Area during 2013 and different levels of nitrogen and application times were evaluated based on their effects on the yield and quality. Random block design with 2 factors were used in the trial in triplicate and different N dosages (0, 150, 200, 250 and 300 kg ha<sup>-1</sup>) at 3 application periods (1.st application period was during sowing/hoeing at the end of June; 2.nd application period was during hoeing in June and in the last week of July; 3.th. application period was during sowing, hoeing in June, July and in the last week of August) were tried. N was, applied at the mentioned amounts and periods using urea (46% N). At sowing, phosphorus (90 kg ha<sup>-1</sup> P<sub>2</sub>O<sub>5</sub>, TSP) and potassium (90 kg ha<sup>-1</sup> K<sub>2</sub>O, K<sub>2</sub>SO<sub>4</sub>) were applied using the sowing machine. As the results of the research, tuber yield, sugar rate in the tuber and refined sugar rate, amino-N and Na contents were affected based on the N applications, at statistically significant levels. While differed based on the N applications, tuber yield of sugar beet was found 75.30 t ha<sup>-1</sup> at the control and the highest increase (18%) was obtained (89.11 t ha<sup>-1</sup>) from the application of 200 kg ha<sup>-1</sup> N.*

**Keywords:** *application time, nitrogen, quality, sugar beet, yield*

---

## 1.INTRODUCTION:

Turkey produces 6.2% of the total world production of sugar beet and about 30% of it is contributed by Konya [1,2]. Our country with 57.2 t ha<sup>-1</sup> yield of sugar beet is too close to world yield of 59.6 t ha<sup>-1</sup>. However, in order to reach to the levels of developed countries in crop production, yield and quality, and to improve the economy of our country, it is necessary to increase the quality and yield of sugar beet. For this, it is crucial to develop good soil by proper irrigation, application of adequate pesticides, implementation of advanced agricultural techniques and providing important nutrients. Application of nitrogen at suitable timing and quantity during sugar beet cultivation, not only increases the yield, but also enhances the sugar content, white sugar content and immunity of plants against diseases, pest and stress conditions. Although several researchers considered nitrogen as one of the most important factors in improving yield and quality of sugar beet like other plants, but inappropriate application of nitrogen may have negative or no effects on plant yield and quality [3, 4, 5].

In one of the studies under Konya growth conditions, it was determined that delayed application of two different fertilizer forms (ammonium nitrate 33% N and ammonium sulfate 21% N) and four different nitrogen doses (0, 5, 10 and 15 kg ha<sup>-1</sup>) increased the root and shoot yield up to an extent of 15 kg ha<sup>-1</sup> N application. However, after this level, yields decreased, raw sugar yield and white sugar yield has fallen gradually with the increase of fertilizer doses, with a maximum decrease at repeated supply of 15 kg ha<sup>-1</sup> N. Sugar rate of the crop decreased with the increasing nitrogen dosages, while other quality related features like amino nitrogen (that is harmful), sodium and potassium content proportionally increased with the nitrogen concentrations. As a result, it was determined that delayed and inappropriate nitrogen application had a negative effect on yield and quality of the crop with an additional loss of producers, business, labor and fertilizer costs [6]. More and late application of nitrogenous fertilizer on sugar beet leads to the decrease in sugar content and enhances the proportion of non-sugar substances, consequently, reducing the purity of the crop [7].

In an experiment investigating the effects of 10 nitrogen dosages (0, 4, 6, 8; 12; 16; 20; 24; 28 and 32 kg ha<sup>-1</sup>) on the quality and quantity of sugar beet, highest root yield (5687 kg ha<sup>-1</sup>) was obtained at 12 kg ha<sup>-1</sup> nitrogen dosage. At lower dosages, root yield was less than control but not proportionate to the reduction. Sugar content changed between 0 and 16 kg ha<sup>-1</sup> nitrogen dosages, however, there was a significant reduction at higher dosages. Highest values of refined sugar yield, 1.031 kg ha<sup>-1</sup> and 1.032 kg ha<sup>-1</sup> were obtained at 8 kg ha<sup>-1</sup> and 12 kg ha<sup>-1</sup> of nitrogen doses, respectively. Some of the features describing quality of sugar beet like amino nitrogen, sodium and potassium proportionally increased with the increasing doses, while after 16 kg ha<sup>-1</sup> dosage their values increased enormously [8]. In this context, this study was conducted to determine the effects of different amounts and timings of nitrogen application on quality and yield of sugar beet.

## Materials and Methods:

In year 2013, experiment was performed through Alakova field trial of Konya Sugar Industry and Trade Company based on Random block design with 2 factorials and 3 replicates. Soil characteristics of field trial have been provided in Table 1.

---

<sup>1</sup>Corresponding author: Selcuk University, Faculty of Agriculture, Department of Soil Science and Plant Nutrition, 42030, Selçuklu/Konya, Turkey, sgezgin@selcuk.edu.tr, fgokmen@selcuk.edu.tr

Table 1. Soil characteristics of field location in the Sugar beet trial

Features	Results	Features	Results
pH (1:2.5)	7.6	Ca (mg kg <sup>-1</sup> )	4699
EC (1:5 , μS/cm)	152	Mg (mg kg <sup>-1</sup> )	342
Org. content (%)	1.3	Na (mg kg <sup>-1</sup> )	46
Lime (%)	19.6	Fe (mg kg <sup>-1</sup> )	4.1
Texture Class	SL	Zn (mg kg <sup>-1</sup> )	0.19
İnorg. N mg kg <sup>-1</sup> )	58	Mn (mg kg <sup>-1</sup> )	5.33
P (mg kg <sup>-1</sup> )	22.8	Cu (mg kg <sup>-1</sup> )	0.89
K (mg kg <sup>-1</sup> )	547	B (mg kg <sup>-1</sup> )	0.63

In sugar beet trial, field soil was sandy in nature and free from negative effects of salinity (EC) and alkalinity (Na %). Soil of trial location was more calcareous in nature with slightly alkaline pH and low organic matter content. In soil, plant's favorable elements P and Mg were in enough quantity, K and Ca content were high, Fe content were medium, Zinc content were less, while Mn, Cu and B content were enough [9] (Table 1). During the plant growth period (April to October), a total rainfall of 113 mm, an average temperature of 19°C and an average humidity of 53% was determined. Dosages of nitrogen and their time of application have been provided in Table 2.

In the month of July and August, nitrogen was applied in the form of ammonium nitrate, while during other timings; it was applied in the form of urea (% 46 N). In sowing, phosphorus (90 kg ha<sup>-1</sup> P<sub>2</sub>O<sub>5</sub>, TSP) and potassium (90 kg ha<sup>-1</sup> K<sub>2</sub>O, K<sub>2</sub>SO<sub>4</sub>) was applied using seed drill. In the experiment, 4 N dosages x 3 application time x 3 replicates + 3 control = 36 parcels were performed. In the trial, in each parcel of size 2.7 x 8 m=21.6 m<sup>2</sup>, Coyote sugar beet were sown during April month using pneumatic seed drill machine with each row of 8 cm and row spacing of 45 cm. These rows were broadened to 20 cm at 4-5 leaves stage by hoeing. Second hoeing was done after 13 days.

Harvest was manually done using harvester. In each plot/parcel, plants in the first two rows at about 1 m distance and one row from the border were thrown in order to get robust results and effective sugar beet harvest was performed in an area of 10.0 m<sup>2</sup>. Later, harvested head and leaves were brought to sugar beet analysis laboratory of Konya Sugar Industry and Trade Company. Prior to cutting for quality analysis, roots were washed with water and weighed to determine the yield. Cleaned roots were chopped in to pieces using machines, further treated with lead acetate and then, after extraction using mixer, determination of sugar content and amino-nitrogen, Na and K were carried out. In laboratory, ratio of sugar content (SC) [10] and refined sugar content of root (RSC), and values of refined sugar content (RSV) were determined using 1<sup>st</sup> and 2<sup>nd</sup> formula mentioned below [11]. The obtained values were statistically analyzed using MSTAT and JMP pack programs.

$$\text{RSC (\%)} = \text{SC} - [0.343 (\text{Na}+\text{K}) + 0.094 \text{ amino-N} + 0.29] \quad (1)$$

$$\text{RSC (kg ha}^{-1}\text{)} = \text{Root yield} \times \text{RSC \%} / 100 \quad (2)$$

Table 2. Nitrogen dosages and time of application

N doses Kg N/ha	N distribution	1. Time of Application				
		At the time of sowing, g Urea/parcel	At the time of Hoeing g Urea/parcel	End of June g Urea/parcel		
0	0	0	0	0		
150	40-55-55	188	258	258		
200	40-80-80	188	376	376		
250	40-105-105	188	493	493		
300	40-130-130	188	610	610		
		2. Time of Application				
		At the time of sowing, g Urea/parcel	At the time of Hoeing g Urea/parcel	End of June g Urea/parcel	July-20 g AN/parcel	
150	40-40-40-30	188	188	188	196	
200	40-50-60-50	188	235	282	327	
250	40-70-70-70	188	329	329	458	
300	40-80-100-80	188	376	470	524	
		3. Time of Application				
		At the time of sowing, g Urea/parcel	At the time of Hoeing g Urea/parcel	End of June g Urea/parcel	July-20 g AN/parcel	August-20 g AN/parcel
150	40-27.5-27.5-27.5-27.5	188	129	129	180	180
200	40-40-40-40-40	188	188	188	262	262
250	40-52.5-52.5-52.5-52.5	188	247	247	344	344
300	40-65-65-65-65	188	305	305	425	425

## Results and Discussion

In this study, variance analysis results and average values obtained from the effect of increasing rates of nitrogen and different time of its application on sugar beet tuber yield, sugar content, amino-N, sodium, potassium and refined sugar content has been provided in Table 3 and Table 4, respectively. According to ANOVA results, nitrogen application has statistically significant effect on tuber yield, sugar content, sodium and refined sugar content of sugar beet roots. This showed that sugar beet tuber yield, sugar content, sodium and refined sugar content is dependent on both the factors i.e., the quantity and time of nitrogen application. Moreover, effect of nitrogen application time was a insignificant on sugar beet tuber yield and other quality features

Table 3. Variance analysis results and effect of different nitrogen dosages and time of application on tuber yield, sugar content, amino-N, sodium, potassium and refined sugar content of sugar beet.

Source of Variance	s.d.	Sum of Squares					
		Tuber yield	Sugar Content	Amino-N	Na	K	RSC
General	44	3520	17.868	22.285	4.428	17.124	29.960
Replicate	2	1207	1.420	1.784	0.376	1.809	2.773
Nitrogen Dosage (ND)	4	973**	12.441*	11.154**	1.466*	2.368	18.361*
Time of Application (TA)	2	73	0.150	0.270	0.151	0.734	0.536
ND*TA interaction	8	132	0.564	0.461	0.317	3.954	1.155
Error	28	1133	3.294	8.616	2.118	8.259	7.136
C.V. (%)	--	7.6	2.2	31.0	16.7	27.8	3.7

\*\* $p < 0.01$ ; \* $p < 0.05$

It can be observed from Table 4 that at the time of controlled nitrogen application, tuber yield was 75.3 t ha<sup>-1</sup>, while it increased 11% to reach 83.26 t ha<sup>-1</sup> at 150 kg ha<sup>-1</sup> nitrogen application, increased 18% to reach 89.1 t ha<sup>-1</sup> at 200 kg ha<sup>-1</sup> nitrogen

application, increased 15% to reach 86.42 t ha<sup>-1</sup> at 250 kg ha<sup>-1</sup> nitrogen application and increased 12% to reach 84.6 t ha<sup>-1</sup> at 300 kg ha<sup>-1</sup> nitrogen application. From the results, the most remarkable point to observe was that tuber yield did not increase too much as compared to the increasing rates of nitrogen application and moreover, decreased after 200 kg ha<sup>-1</sup> nitrogen application. Additionally, no significant difference has been determined on a comparison between yield and time of nitrogen application. In this case, an exceptional thing in the experimental location was the development of inorganic nitrogen (NH<sub>4</sub>+NO<sub>3</sub>-N) with pretty good quantity (58 N mg kg<sup>-1</sup> or 145 N kg ha<sup>-1</sup>) that is easily absorbed by the plants. Plant sugar content during controlled conditions at average time of nitrogen application was 16.5%, while on increasing the nitrogen concentration it decreased between 5.4% and 9.3% as compared to control.

Table4. Effects of different nitrogen dosages and time of application on tuber yield, sugar content and amino-N of sugar beet\*

N dosage, kg ha <sup>-1</sup>	Tuber Yield, t ha <sup>-1</sup>				Sugar Content, %				Amino-N, mmol 100 g <sup>-1</sup>			
	Time of App.				Time of App.				Time of App.			
	1	2	3	avg	1	2	3	avg	1	2	3	avg
0	75.3	75.3	75.3	75.3	16.5	16.5	16.5	16.5	1.10	1.10	1.10	1.10
150	87.1	79.4	83.3	83.3	15.6	15.9	15.4	15.6	2.23	1.83	1.96	2.01
200	87.7	87.7	91.9	89.1	15.2	15.4	15.3	15.3	2.01	2.00	1.83	1.95
250	85.9	86.4	87.0	86.4	15.6	15.3	15.3	15.4	2.58	2.68	2.27	2.51
300	83.2	81.9	88.7	84.6	15.1	14.9	14.9	14.9	2.58	2.26	2.40	2.41
Avg	83.8	82.1	85.2	--	15.6	15.6	15.5	--	2.10	1.98	1.91	--

\* Average values of 3 replicates

While sugar content, amino-N and sodium content in tuber of sugarbeet were not significantly affected with the time of nitrogen application, as average timings of application, amino-nitrogen values changed between 83% and 230% and sodium values changed between 68% and 94% with the increasing of applied nitrogen rates (Table 4 and Table 5). According to the increasing applied nitrogen values and consequent increase in the amino-N and sodium values with proportional increase in sugar content, refined sugar content also changed between 8.5% and 12% (Table 4 and Table 5). Similar to yield and other quality features, refined sugar content was also unaffected by the time of nitrogen applications.

Table5. Effects of different nitrogen dosages and time of application on tuber Na content, K content and refined sugar content of sugar beet\*

N dosage, kg ha <sup>-1</sup>	Sodium, mmol 100 g <sup>-1</sup>				Potassium, mmol 100 g <sup>-1</sup>				Refined Sugar Content, %			
	Time of Application				Time of Application				Time of Application			
	1	2	3	avg	1	2	3	avg	1	2	3	avg
0	0.53	0.53	0.53	0.53	3.06	3.06	3.06	3.06	14.90	14.90	14.90	14.90
150	1.00	0.73	0.94	0.89	3.51	3.62	3.63	3.59	13.53	14.01	13.34	13.63
200	1.08	0.94	0.93	0.98	3.56	3.47	3.13	3.39	13.11	13.37	13.43	13.30
250	0.97	1.07	1.05	1.03	3.68	3.20	3.14	3.34	13.43	13.32	13.38	13.38
300	1.04	0.74	1.17	0.98	3.12	2.09	3.65	2.95	13.13	13.47	12.75	13.12
Avg	0.92	0.80	0.92		3.39	3.09	3.32		13.62	13.81	13.56	

\* Average values of 3 replicates

## 2. CONCLUSIONS:

In this study on sugar beet, it was determined that different nitrogen dosages application had a significant effect on tuber yield, sugar content, refined sugar content, amino-N and Na values, while these were not significantly affected by the time of applications. In our trial, the time of nitrogen applications did not have significant effects on the yield and quality features of sugar beet may be because of inadequate consumption of applied nitrogen due to concurrence of last nitrogen application time (Early October) and time of crop harvest. Moreover, we found that tuber yield increases depending on the variation in nitrogen application.

## REFERENCES

- [20]. FAO, 2015. <http://faostat3.fao.org/browse/T/>
- [21]. Tüik, 2014. <http://www.tuik.gov.tr/bitkiselapp/bitkisel.zul>.
- [22]. P. Stmad, and M. Javurek, 'Dependence of Yield Formation and Quality on Nutrient Uptake in Sugarbeet'. Rostlinna-Vyroba, 37: 5, 405-412. 1991.
- [23]. K. M. Çimrin, 'Gübrelemenin Şeker Pancarının N, P, K İçeriğine Alımına Etkisi'. Yüzüncü Yıl Üniversitesi, Ziraat Fakültesi, Tarım Bilimleri Dergisi (J. Agric. Sci.), 2001, 11(1):5-10. 2001.
- [24]. Çelik, T., 'Farklı azot ve fosfor miktarlarının şeker pancarındaki kök-gövde verim ve bazı kalite özelliklerine etkisi', Yüksek Lisans Tezi, Harran Üniversitesi Fen Bilimleri Enstitüsü, Şanlıurfa, 28-44. 2003.
- [25]. Demirhan, T. 'Geçmiş dönemdeki farklı form ve dozlardaki azotün şeker pancarının verim ve kalitesine etkisi', Yüksek Lisans Tezi, Selçuk Üniversitesi Fen Bilimleri Enstitüsü, Konya, 48. 2011

- [26]. Er, C. ve Yıldız, M. 'Şekerpancarında beslenme ve kalite ilişkileri', 2. *Gübreleme ve Sulama ŞekerPancarı Yetiştirme Tekniği Sempozyumu*, S.Ü. ZiraatFakültesi, Konya PancarEkicileriKooperatifi, Konya, 125-131. 1994.
- [27]. M. Turhan, ve A. Pişkin, 'Değişikdozlarda uygulanan azotun şekerpancarının verim ve kalitesine etkisi', *Türkiye 3. Ulusal Gübre Kongresi*, Tokat, 433-440. 2004.
- [28]. N. Ülgen, N. Yurtsever, *Türkiye Gübre ve Gübreleme Rehberi*. Toprak Su Genel Müdürlüğü Araştırma Dairesi Başkanlığı, Yayın No: 47, Ankara. 1984.
- [29]. ICUMSA, 'Report of the Proceedings'. 16th Session, Subj. 12, Rec. (1): 156. 1974.
- [30]. N. Kubadinow, L. Wieninger, *Comp. Rend. XIV. Ass. Comm. Int. Teach. Sucr. (Cits) Brussel*, 1971, 539; *S.A. Zucker*. 25: 43. 1972.

# Data Mining Techniques in Database Systems

*Ledion Lico<sup>1</sup>*

---

## Abstract

*At the current stage the technologies for generating and collecting data have been advancing rapidly. The main problem is the extraction of valuable and accurate information from large data sets. One of the main techniques for solving this problem is Data Mining. Data mining (DM) is the process of identification and extraction of useful information in typically large databases. DM aims to automatically discover the knowledge that is not easily perceivable. It uses statistical analysis and artificial intelligence (AI) techniques together to address the issues. There are different types of tasks associated to data mining process. Each task can be thought of as a particular kind of problem to be solved by a data mining algorithm. The main types of tasks performed by DM algorithms are:*

- *Classification:*
- *Association:*
- *Clustering:*
- *Regression:*
- *Anomaly Detection:*
- *Feature Extraction*
- *Time Series Analyses*

*In this paper we will perform a survey of the techniques above. A secondary goal of our paper is to give an overview of how DM is integrated in Business Intelligence (BI) systems. BI refers to a set of tools used for multidimensional data analysis, with the main purpose to facilitate decision making. One of the main components of BI systems is OLAP. The main OLAP component is the data cube which is a multidimensional database model that with various techniques has accomplished an incredible speed-up of analyzing and processing large data sets. We will discuss the advantages of integrating DM tools in BI systems.*

**Keywords:** *Data Mining, BI, OLAP, AI, OLAM*

---

## 1. INTRODUCTION

Data mining is the process used to describe knowledge in databases. Data mining process is very much useful for extracting and identifying useful information and subsequent knowledge from large databases. It uses different techniques such as statistical, mathematical, artificial intelligence and machine learning as the computing techniques. Its predictive power comes from unique design by combining techniques from machine learning, pattern recognition, and statistics to automatically extract concepts, and to determine the targeted interrelations and patterns from large databases. Organizations get help to use their current reporting capabilities to discover and identify the hidden patterns in databases. The extracted patterns from the database are then used to build data mining models, and can be used to predict performance and behavior with high accuracy [2]. Descriptive and Predictive data mining are the most important approaches that are used to discover hidden information[1] Data Mining has become an established discipline within the scope of computer science. The origins of data mining can be traced back to the late 80s when the term began to be used, at least within the research community. In the early days there was little agreement on what the term data mining encompassed, and it can be argued that in some sense this is still the case. Broadly data mining can be determined as a set of mechanisms and techniques, realized in software, to extract hidden information from data. The word hidden in this definition is important; SQL style querying, however sophisticated, is not data mining. By the early 1990s data mining was commonly recognized as a sub-process within a larger process called Knowledge Discovery in Databases or KDD. The most commonly used definition of KDD is that attributed to (Fayyad et al. 1996).. "The nontrivial process of identifying valid, novel, potentially useful, and ultimately understandable patterns in data" (Fayyad et al. 1996). As such data mining should be viewed as the sub-process, within the overall KDD process, concerned with the discovery of hidden information". Other sub-processes that form part of the KDD process are data preparation (warehousing, data cleaning, pre-processing, etc) and the analysis/visualization of results. For many practical purposes KDD and data mining are seen as synonymous, but technically one is a sub-process of the other. There are two important models in Data Mining: The Descriptive Model and The Predictive Model.

---

<sup>1</sup>Polytechnic University of Tirana, Faculty of Information Technology, Tirana, Albania [ledionlico@hotmail.com](mailto:ledionlico@hotmail.com)



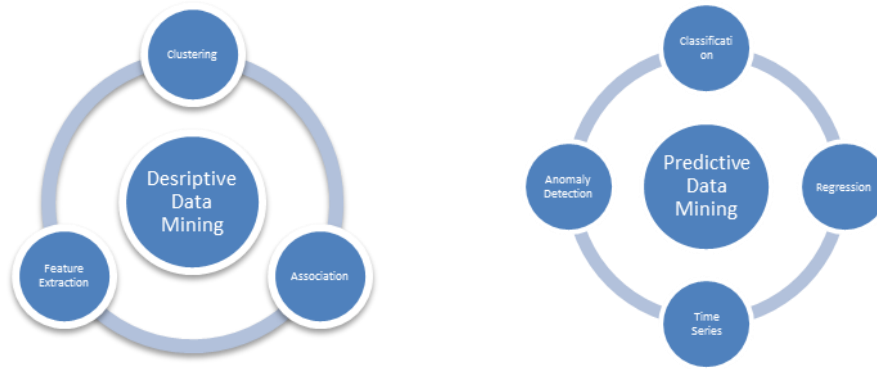

Figure 1. Descriptive (unsupervised) and Predictive (supervised) Data Mining

Descriptive model looks at data and analyzes past events for insight as to how to approach the future. This technique is also known as unsupervised learning. Descriptive analytics looks at past performance and understands that performance by mining historical data to look for the reasons behind past success or failure. Almost all management reporting such as sales, marketing, operations, and finance, uses this type of post-mortem analysis. Descriptive models quantify relationships in data in a way that is often used to classify customers or prospects into groups. Unlike predictive models that focus on predicting a single customer behavior, descriptive models identify many different relationships between customers or products. Descriptive models do not rank-order customers by their likelihood of taking a particular action the way predictive models do. The Descriptive model uses techniques as Clustering, Association Rules, Summarizations, and Feature Extraction.

Predictive models turns data into valuable, actionable information. Predictive analytics uses data to determine the probable future outcome of an event or a likelihood of a situation occurring. This technique is also known as supervised learning. Supervised data mining techniques are appropriate when you have a specific target value to predict about your data. The targets can have two or more possible outcomes, or even be a continuous numeric value. In business, predictive models exploit patterns found in historical and transactional data to identify risks and opportunities. Models capture relationships among many factors to allow assessment of risk or potential associated with a particular set of conditions, guiding decision making for candidate transactions. The Predictive data mining model includes Classification, Anomaly Detection, Regression and Analysis of Time Series.

## 2. THE DESCRIPTIVE MODEL

There are 3 important techniques used in the descriptive model: Clustering, Association, Feature Extraction.

### Clustering

Clustering is an important technique in data mining and it is the process of partitioning data into a set of clusters such that each object in a cluster is similar to another object in the same cluster, and dissimilar to every object not in the same cluster. Dissimilarities and similarities are assessed based on the attribute values describing the objects and often involve distance measures. Clustering analyses the data objects without consulting a known class label. This is because class labels are not known in the first place, and clustering is used to find those labels. Good clustering exhibits high intra-class similarity and low inter-class similarity, that is, the higher the similarity of objects in a given cluster, the better the clustering. The superiority of a clustering algorithm depends equally on the similarity measure used by the method and its implementation. The superiority also depends on the algorithm's ability to find out some or all of the hidden patterns. The different ways in which clustering methods can be compared are partitioning criteria, separation of clusters, similarity measures and clustering space. Clustering algorithms can be categorized into partition-based algorithms, hierarchical-based algorithms, density-based algorithms and grid-based algorithms.

Table 1. Some of the most used Clustering Algorithms

Partition-based algorithms	Hierarchical-based algorithms	Density-based algorithms	Grid-based algorithms
K-Means	Agglomerative (BIRCH, CHAMALEON)	DBSCAN	STING
K-Medoids (PAM, CLARA)	Divisive	DENCLUE	CLIQUE

These methods vary in (i) the procedures used for measuring the similarity (within and between clusters) (ii) the use of thresholds in constructing clusters (iii) the manner of clustering, that is, whether they allow objects to belong to strictly to one cluster or can belong to more clusters in different degrees and the structure of the algorithm[3].

## Association

Another important data mining technique is association rule mining. Association rule technique searches for relationships among variables. For example, a shop might gather data about how the customer is purchasing the various products. With the help of association rule, the shop can identify which products are frequently bought together and this information can be used for marketing purposes. This is sometimes known as market basket analysis. The patterns discovered with this data mining technique can be represented in the form of association rules. Rule support and confidence are two measures of rule interestingness. Typically, association rules are considered interesting if they satisfy both a minimum support threshold and a minimum confidence threshold. Such thresholds can be set by users or domain experts.

*Definition.* Let  $I=\{I_1, I_2, \dots, I_m\}$  be a set of items. Let  $D$ , the task relevant data, be a set of database transactions where each transaction  $T$  is a set of items such that  $T \subseteq I$ . Each transaction is associated with an identifier, called TID. Let  $A$  be a set of items. A transaction  $T$  is said to contain  $A$  if and only if  $A \subseteq T$ . An association rule is an implication of the form  $A \rightarrow B$ , where  $A \subset I$ ,  $B \subset I$  and  $A \cap B = \emptyset$ . The rule  $A \rightarrow B$  holds in the transaction set  $D$  with support  $s$ , where  $s$  is the percentage of transactions in  $D$  that contain  $A \cup B$ . The rule  $A \rightarrow B$  has confidence  $c$  in the transaction set  $D$  if  $c$  determines how frequently items in  $B$  appear in transactions that contain  $A$ . That is,  $\text{support}(A \rightarrow B) = \text{Prob}\{A \cup B\}$  and  $\text{confidence}(A \rightarrow B) = \text{Prob}\{B/A\}$ . [4]

Table 2. An example of market basket transactions

TID	Item
1	{Jeans,T-Shirt,Shoes,Chocolate}
2	{Jeans,Shoes,Coat,Sunglasses}
3	{Watch,Bag,,Jeans,T-Shirt}
4	{Belt,Jeans,Shirt,Shoes}

Lets assume that that itemset  $A$  includes {Jeans,T-Shirt} and itemset  $B$  includes {Shoes}.The rule {Jeans,T-Shirt} $\rightarrow$ {Shoes} has a support value of  $2/4 = 0.5$  and a confidence value of  $2/3 = 0.67$ . Rules that satisfy both a user-specified minimum support threshold and a minimum user-specified confidence threshold (minconf) are called strong.

Some of the most important association algorithms are : AIS, SETM, Apriori, Aprioritid, Apriorihybrid, FP-Growth. From the recent studies it is observed that, FP-growth performs better ind terms of speed and accuracy than the older AIS, SETM, Apriori, Aprioritid, Apriorihybrid [5]

## Feature Extraction

Feature extraction creates new features based on attributes of your data. These new features describe a combination of significant attribute value patterns in your data. Models built on extracted features may be of higher quality, because the data is described by fewer, more meaningful attributes.. Unlike feature selection, which ranks the existing attributes according to their predictive significance, feature extraction actually transforms the attributes. The transformed attributes, or features, are linear combinations of the original attributes. Representing data points by their features can help compress the data (trading dozens of attributes for one feature), make predictions (data with this feature often has these attributes as well), and recognize patterns. Additionally, features can be used as new attributes, which can improve the efficiency and accuracy of supervised learning techniques (classification, regression, anomaly detection, etc.).

Some of the most commonly used techniques for feature extraction are: Principal Component Analysis (PCA) and Linear Discriminant Analysis (LDA) .Principal Component Analysis (PCA) is the most popular statistical method. This method extracts a lower dimensional space by analyzing the covariance structure of multivariate statistical observations. Linear Discriminant Analysis (LDA) technique mainly projects the high-dimensional data into lower dimensional space. LDA aims to maximize the between-class distance and minimize the within-class distance in the dimensionality reduced space. [6] Many extensions to of LDA technique have been proposed in the past like NLDA(Null space LDA) and OLDA (Orthogonal LDA).An asymmetric principal component analysis (APCA) was proposed by Jiang et 2009 to remove the unreliable dimensions more effectively than the conventional PCA.

## 3.THE PREDICTIVE MODEL

There are 4 important techniques used in the descriptive model: Classification, Regression, Time Series and Anomaly Detection.

### Classification

Classification techniques in data mining are capable of processing a large amount of data. It can be used to predict categorical class labels and classifies data based on training set and class labels and it can be used for classifying newly available data. The term could cover any context in which some decision or forecast is made on the basis of presently available information. Classification procedure is recognized method for repeatedly making such decisions in new situations. Creation of a

classification procedure from a set of data for which the exact classes are known in advance is termed as pattern recognition or supervised learning. Contexts in which a classification task is fundamental include, for example, assigning individuals to credit status on the basis of financial and other personal information, and the initial diagnosis of a patient's disease in order to select immediate treatment while awaiting perfect test results. Some of the most critical problems arising in science, industry and commerce can be called as classification or decision problems.

Classification consists of predicting a certain outcome based on a given input. In order to predict the outcome, the algorithm processes a training set containing a set of attributes and the respective outcome, usually called goal or prediction attribute. The algorithm tries to discover relationships between the attributes that would make it possible to predict the outcome. Next the algorithm is given a data set not seen before, called prediction set, which contains the same set of attributes, except for the prediction attribute – not yet known. The algorithm analyses the input and produces a prediction. [7] For example in a hospital where the target attribute is the illness of the patient, in the hospital database the training set will include the symptoms of the previous recorded patients and the illness as a target. The algorithm than is given a prediction set with the data from the new patient except the illness which is the one attribute needed to predict. The prediction accuracy defines how "good" the algorithm is. How well predictions are done is measured in percentage of predictions hit against the total number of predictions. A decent rule ought to have a hit rate greater than the occurrence of the prediction attribute.

The commonly used methods for data mining classification tasks can be classified into the following groups [8] .

- Decision Trees (DT's)
- Support Vector Machine (SVM)
- Genetic Algorithms (GAs) / Evolutionary Programming (EP)
- Fuzzy Sets
- Neural Networks
- Rough Sets

Multi-Objective Genetic Algorithms (MOGA) have been also used recently to address classification data mining tasks.

### Regression

Regression is a data mining (machine learning) technique used to fit an equation to a dataset. It is more used when the target attribute has a numeric value. It can be used to model the relationship between one or more independent variables and dependent variables. In data mining independent variables are attributes already known and response variables are what we want to predict. The main types of regression methods are:

- Linear Regression
- Multivariate Linear Regression
- Nonlinear Regression
- Multivariate Nonlinear Regression

The simplest form of regression, linear regression, uses the formula of a straight line ( $y = mx + b$ ) and determines the appropriate values for  $m$  and  $b$  to predict the value of  $y$  based upon a given value of the coefficients,  $m$  and  $b$  (called *regression coefficients*), specify the slope of the line and the  $Y$ -intercept, respectively. Multivariate linear regression is an extension of (simple) linear regression, which allows a response variable,  $y$ , to be modeled as a linear function of two or more predictor variables [11].

Often the relationship between  $x$  and  $y$  cannot be approximated with a straight line. In this case, a nonlinear regression technique may be used. Alternatively, the data could be preprocessed to make the relationship linear. Nonlinear regression models define  $y$  as a function of  $x$  using an equation that is more complicated than the linear regression equation. The term multivariate nonlinear regression refers to nonlinear regression with two or more predictors ( $x_1, x_2, \dots, x_n$ ). When multiple predictors are used, the nonlinear relationship cannot be visualized in two-dimensional space.

Unfortunately, many real-world problems are not simply prediction. For instance, sales volumes, stock prices, and product failure rates are all very difficult to predict because they may depend on complex interactions of multiple predictor variables. Therefore, more complex techniques (e.g., logistic regression, decision trees, or neural networks) may be necessary to forecast future values. The same model types can often be used for both regression and classification. For example, the CART (Classification and Regression Trees) decision tree algorithm can be used to build both classification trees (to classify categorical response variables) and regression trees (to forecast continuous response variables). Neural networks too can create both classification and regression models.

### Time Series

A time series is a collection of observations made sequentially through time. At each time point one or more measurements may be monitored corresponding to one or more attributes under consideration. The resulting time series is called univariate or multivariate respectively. In many cases the term sequence is used in order to refer to a time series, although some authors refer to this term only when the corresponding values are non-numerical.

The most common tasks of TSDM methods are: indexing, clustering, classification, novelty detection, motif discovery and rule discovery. In most of the cases, forecasting is based on the outcomes of the other tasks. A brief description of each task is given below. [12].

Indexing: Find the most similar time series in a database to a given query time series.

Clustering: Find groups of time series in a database such that, time series of the same group are similar to each other whereas time series from different groups are dissimilar to each other.

Classification: Assign a given time series to a predefined group in a way that is more similar to other time series of the same group than it is to time series from other groups.

Novelty detection: Find all sections of a time series that contain a different behavior than the expected with respect to some base model.

Motif discovery: Detect previously unknown repeated patterns in a time series database.

Rule discovery: Infer rules from one or more time series describing the most possible behavior that they might present at a specific time point (or interval).

This method of DM, unveils numerous facets of complexity. The most prominent problems arise from the high dimensionality of time-series data and the difficulty of defining a form of similarity measure based on human perception.

## Anomaly Detection

Data object is considered to be an outlier if it has significant deviation from the regular pattern of the common data behavior in a specific domain. Generally it means that this data object is “dissimilar” to the other observations in the dataset. It is very important to detect these objects during the data analysis to treat them differently from the other data. Anomaly Detection is the process of finding outlying record from a given data set. This problem has been of increasing importance due to the increase in the size of data and the need to efficiently extract those outlying records which could indicate unauthorized access of the system, credit card theft or the diagnosis of a disease.

Anomalies can be classified into either point anomalies contextual anomalies or collective anomalies. The earlier is when single data records deviate from the remainder of the data sets. This is the simplest kind and the one which is most addressed by the existing algorithms. Contextual anomalies is when the record has behavioral as well as contextual attributes. The same behavioral attributes could be considered normal in a giving context and anomalous in another. Whilst the collective anomalies is when a group of similar data are deviating from the remainder of the data set. This can only occur in data sets where the records are related to each other. Contextual anomalies can be converted into point anomalies by aggregating over the context. The algorithms implemented in the extension all explicitly handle point anomalies [10].

According to the anomaly detection survey [9] the techniques can be grouped into one of the following main categories *classification based*, *nearest-neighbor based*, *clustering based* and *statistical based*. Classification based algorithms are mainly supervised algorithms that assumes that the distinction between anomalous and normal instances can be modeled for a particular feature space. Nearest-neighbor based algorithms assume that anomalies lie in sparse neighborhoods and that they are distant from their nearest neighbors. They are mainly unsupervised algorithms. Clustering based algorithms work by grouping similar objects into clusters and assume that anomalies either do not belong to any cluster, or that they are distant from their cluster centers or that they belong to small and sparse clusters. Statistical approaches label objects as anomalies if they deviate from the assumed stochastic model. Anomaly Detection methods are widely used for fraud or suspicious transtaction detection in financial organizations.

## 4. DATA MINING TOOLS IN BI SYSTEMS

BI(Business Intelligence) refers to a set of tools used for multidimensional data analysis, with the main purpose to facilitate decision making. One of the main components of BI systems is OLAP(Online Analytical Processing). The main OLAP component is the data cube which is a multidimensional database model that with various techniques has accomplished an incredible speed-up of analyzing and processing large data sets. In our last paper [13], we studied OLAP and compared different implementations of it such as ROLAP, MOLAP, HOLAP in terms of performance and data accuracy. In our simulations we compared two technologies: ROLAP that performs query against DW and HOLAP which uses intelligent cubes. It was highlighted the efficiency of these intelligent cubes that reduced drastically the response time of the system. They also use a very good compression and the space occupied in memory is small. As the cubes are stored on the OLAP server, which means that will take reports even if the server where the database is hosted is down. Generally the usage of intelligent cubes when databases are large increases the efficiency, the performance and allows to have reports at any time even with the disadvantage of a memory occupied larger.

Another fundamental advantage of OLAP tools is that the user gets a multidimensional information and the reporting is flexible.

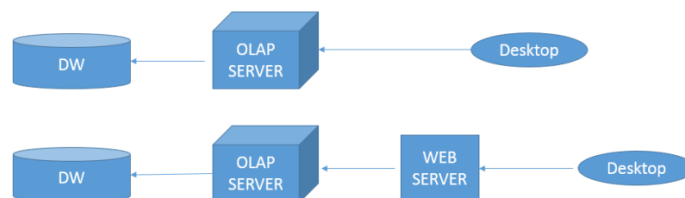

Figure 2. OLAP architecture with three and four levels

We concluded that OLAP is powerful tool for data extraction in BI systems and has a very good time efficiency in queries against large databases (data warehouses). OLAP is very flexible with columns and rows, and it is possible to report in several dimensions. Although small organizations with a limited database might not need all the capacity of OLAP tools.

OLAP applications are widely used by Data Mining techniques. In OLAP database there is aggregated, historical data, stored in multi-dimensional schemas (usually star schema). The star schemas in data warehouses increases the performance due to the small number of connections that have to do to get a report. Several works in the past proved the likelihood and interest of integrating OLAP with data mining and as a result a new promising direction of Online Analytical Mining (OLAM) has emerged. The term OLAM was firstly introduced by Han in [14]. Issues for On-Line Analytical Mining of Data Warehouses were analyzed by HAN, Chee and Chinag in [15]. The purpose of integrating OLAP with data mining is because of the high quality of data in data warehouses, available information processing infrastructure surrounding data warehouses, OLAP-based exploratory data analysis and on-line selection of data mining functions..An architecture that integrated OLAP and OLAM was proposed in this paper.

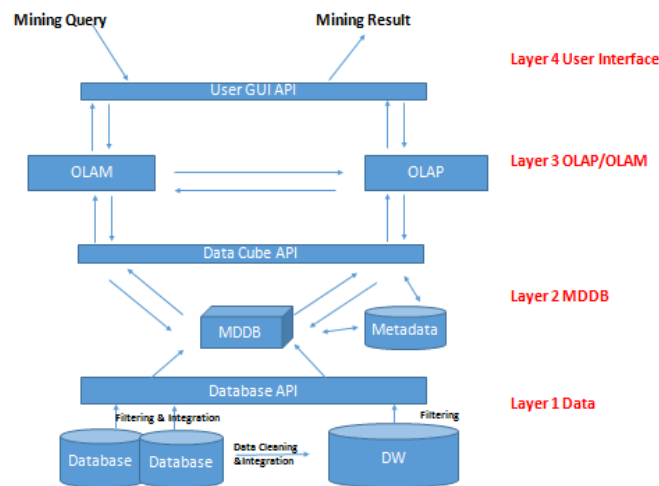

Figure 3. OLAM Architecture

Hua [16] proposed and developed an interesting association rule mining approach called Online Analytical Mining of association rules. It integrated OLAP technology with association rule mining methods and leads to flexible multidimensional and multi-level association rule mining. Dzeroski et al. [17] combined OLAP and Data Mining in a different way to discover patterns in a database of patients. Two data mining techniques, clustering and decision tree induction were used. Clustering was used to group patients according to the overall presence/absence of deletions at the tested markers. Decision trees and OLAP were used to inspect the resulting clustering and to look for correlations between deletion patterns, populations and the clinical picture of infertility. Dehne et al. [18] studied the applicability of coarse grained parallel computing model (CGM) to OLAP for data mining. Authors presented a general framework for the CGM which allows for the efficient parallelization of the existing data cube construction algorithm for OLAP. Experimental data showed that this approach yield optimal speed up even when run on a simple processor cluster via a standard switch. The study shows that OLAP and data mining, if combined together, can produce greater benefits in a number of diverse research areas. Usman and Asghar in [19] combined enhanced OLAP and data mining techniques but their main focus was on a particular data mining technique known as Hierarchical Clustering. Furthermore, they used data mining as a pre-processing step to get better understanding of data before passing it to the automatic schema builder and which then generates schema for OLAP engine. They proposed an integrated OLAM architecture which integrates enhanced OLAP with data mining and to provide automatic schema generation from the mined data. This proposed architecture improved the performance of OLAP and added extra intelligence to the OLAP system. Experimental results proved that the proposed architecture improved the cube construction time, empowered interactive data visualization, automated schema generation, and enabled targeted and focused analysis at the front-end.

Although there is little research in this area recently and integration of other different techniques of data-mining with OLAP needs to be done. One of the largest computer technologies companies Oracle has integrated OLAP and data mining capabilities directly into the database server. Oracle OLAP and Oracle Data Mining (ODM) are options to the Oracle Database.

## 5. CONCLUSION

Data mining offers numerous ways to uncover hidden patterns within large amounts of data. These hidden patterns can potentially be used to predict future behavior. Good data is the first requirement for good data exploration. There are various techniques and algorithms that can be used to perform data-mining but their use depends on the application. Predictive data mining techniques are appropriate when you have a specific target value you'd like to predict about your data. Predictive analytics can be used for forecasting customer behavior and purchasing patterns to identifying trends in sales activities. On the other hand descriptive data mining does not focus on predetermined attributes, nor does it predict a target value. Rather,

descriptive data mining finds hidden structure and relation among data. Descriptive analytics are useful because they allow us to learn from past behaviors, and understand how they might influence future outcomes. In this paper a survey of the most important data mining techniques and algorithms for both models was made.

Also a review of the existing work in combining different techniques of Data Mining with OLAP was made and the advantages were mentioned. Combining OLAP and data mining techniques can provide a very effective way for extracting hidden or useful information in large datasets. This combination gives us an intelligent system improved in performance with data mining capabilities. We conclude that there is little research in this area recently and integration of other different techniques of data-mining with OLAP needs to be done. Our future work consists in combining and testing various data mining techniques in combination with OLAP in databases and comparing their efficiency in terms of data retrieval speed and data quality.

## REFERENCES

- [1] Frans Coenen, 'Data Mining: Past, Present and Future', *The Knowledge Engineering Review*, 2004, Cambridge University Press
- [2] Pradnya P. Sondwale, Overview of Predictive and Descriptive Data Mining Techniques, *International Journal of Advanced Research in Computer Science and Software Engineering*, April 2015
- [3] Mihika Shah, Sindhu Nair, A Survey of Data Mining Clustering Algorithms, *International Journal of Computer Applications (0975 – 8887) Volume 128 – No.1, October 2015*
- [4] Irina Tudor, Association Rule Mining as a Data Mining Technique, *Petroleum-Gas University of Ploiești, Buletin Vol. LX No. 1/2008*
- [5] Trupti A. Kumbhare et al An Overview of Association Rule Mining Algorithms, / (IJCSIT) *International Journal of Computer Science and Information Technologies*, Vol. 5 (1), 2014, 927-930
- [6] N. Elavarasan, Dr. K.Mani, A Survey on Feature Extraction Techniques, *International Journal of Innovative Research in Computer and Communication Engineering Vol. 3, Issue 1, January 2015*
- [7] Fabricio Voznika Leonardo Viana "DATA MINING CLASSIFICATION" Springer, 2001
- [8] A. Shameem Fathima, D. Manimegalai, Nisar Hundewale, A Review of Data Mining Classification Techniques Applied for Diagnosis and Prognosis of the Arbovirus-Dengue *IJCSI International Journal of Computer Science Issues*, Vol. 8, Issue 6, No 3, November 2011
- [9] Varun Chandola, Arindam Banerjee, and Vipin Kumar. Anomaly Detection: A Survey. *Technical report, University of Minnesota, 2007.*
- [10] Victoria Hodge and Jim Austin. A survey of outlier detection methodologies. *Artificial Intelligence Review*, 22:85126, 2004
- [11] Han - Data Mining Concepts and Techniques 3rd Edition - 2012.pdf
- [12] Shanta Rangaswamy, Time Series Data Mining Tool, *International Journal of Research in Computer and Communication Technology*, Vol 2, Issue 10, October- 2013
- [13] Zana, Lico A multidimensional analyses in Business Intelligence systems *IJCSIS May 2012*
- [14] J. Han, "Towards online analytical mining in large databases," *ACM SIGMOD Record*, vol. 27, no. 1, pp. 97-107, March 1998.
- [15] J. Han, S. H. S. Chee and J. Y. Chiang, "Issues for online analytical mining of data warehouses," in *Proc. Of the SIGMOD Workshop on Research Issues on Data Mining and Knowledge Discovery (DMKD)*, Seattle, 1998, pp. 2:1-2:5.
- [16] H. Zhu, "Online analytical mining of association rules," *Master Thesis, Simon Fraser University, 1998*, pp. 1-117.
- [17] S. Dzeroski, D. Hristovski and B. Peterlin, "Using data mining and OLAP to discover patterns in a database of patients with Y chromosome deletions," in *Proc. AMIA Symp.*, 2000, pp. 215-219.
- [18] F. Dehne, T. Eavis and A. Rau-Chaplin, "Coarse grained parallel on-line analytical processing (OLAP) for data mining, in *Proc. of the Int'l Conf. on Computational Science (ICCS)*, 2001, 589-598.
- [19] Usman, Asghar, An Architecture for Integrated Online Analytical Mining, *JOURNAL OF EMERGING TECHNOLOGIES IN WEB INTELLIGENCE*, VOL. 3, NO. 2, MAY 2011
- [20] Han - Data Mining Concepts and Techniques 2nd Edition - 2006.pdf
- [21] NGUYEN Feature Extraction for Outlier Detection in High-Dimensional Spaces, *JMLR: Workshop and Conference Proceedings 10: 66-75 The Fourth Workshop on Feature Selection in Data Mining*

## BIOGRAPHY

Ledion Liço has a Scientific Master Degree in Electronic Engineering from the Polytechnic University of Tirana (UPT), Faculty of Information Technology (2011). He is currently following the PHD program near UPT. He is working as Head of IT Division near Gener2 company and he is also involved as a part-time lecturer in the UPT University, Tirana, Albania.

# The Güzelcehisar-Bartın Coastal Landscape Heritage Project

Canan Cengiz<sup>1</sup>, Bulent Cengiz<sup>2</sup>

---

## Abstract

Coastal areas are sensitive for their cultural values and their distinctive ecological characteristics. Generating ecological landscape planning approaches based on a balance of protection and usage balance in coastal areas is particularly important for the sustainability of these sensitive areas. Güzelcehisar, an archaeological residential site on the rural Black Sea coast, the natural and cultural values of which have been significantly protected, was chosen as the study area. Located 17 kilometres from Bartın, it is one of the rare areas in the neighborhood of this city where citrus fruits can be grown in the Black Sea climate due to its microclimate. Güzelcehisar has 80 million-year-old special geomorphological formations featuring natural monuments in the coastal area and these formations are called the Lava Pillars due to their volcanic structure. The diameter of the lava pillars is 50–100 centimeters, and their height is over 30 meters. The lava pillars in the Northern Ireland, Scotland and California were put under protection and acknowledged as natural heritages. Güzelcehisar Coast Lava Pillars, which are among the suggestions for the Geological Heritage Inventory in Turkey, are one of the world's exceptionally developed natural formations. However, Güzelcehisar Coast Lava Pillars have yet to be known adequately in the country where they are located. This paper reveals the landscape potential of Güzelcehisar Coast Lava Pillars and compares it to their equivalents in the rest of the world. Strategic suggestions have been developed to evaluate the Lava Pillars focusing on sustainable tourism as coastal geological heritage areas.

**Keywords:** coastal landscape, coastal heritage, lava pillars, Güzelcehisar

---

## 1. INTRODUCTION

Coastal areas are delicate landscapes with their ecological features peculiar to themselves as well as their cultural values. The surface of the coastal areas that constitute the land includes beaches, dunes, breakwaters, cliffs and precipices and rock fields, wetted areas, plains, mountainsides and rough areas. Turkish coasts are preferred for space usage particularly because of their natural beauties, and cultural and historical values; besides, they are face to face with much environmental oppression [1]. According to Kayır [2], alongside with their ecological features, coastal areas own high landscape values that enable multiple spatial solutions like cultural usages for tourism and recreation. Therefore, coastal areas highly contribute to the quality and character of the rural and urban landscape [1]. In the planning and design of the coastal areas which are treated exclusively with their natural and cultural resources; developing strategies suitable for the definition, features and problems of the coast is highly important in terms of their conservation and usage [3].

The geological and cultural significance of coastal areas has led to various national and international designations based on its geology, geomorphology, landscape and associated habitats. In this context, understanding Geodiversity and Geoconservation terms has an importance for Coastal Landscape Heritage Project.

According to Stanley [4] “Geodiversity is the variety of geological environments, phenomena and active processes that make landscapes, rocks, minerals, fossils and soils and other superficial deposits which provide the framework for life on Earth. Geodiversity is also the link between people, landscapes and their culture...”

Geoconservation is the conservation of geodiversity and is generally defined as the recognition, protection and management of sites and landscapes identified as important for their fossils, minerals, soils or other geological and geomorphological features of interest (that is, geodiversity interest). Since geoconservation involves more than just recognition, protection and management, the definition by Burek and Prosser [5] seems to sum up the essence of geoconservation by defining it as “action taken with the intent of conserving and enhancing geological and geomorphological features, processes, sites and specimens” (Burek and Prosser 2008). Therefore, a key aspect of geoconservation is the protection of sites and landscapes that have been identified as having some important geodiversity interest [6].

Thirty four percent of the current coastline of England and Wales is protected by the Heritage Coast Program and its main tenets are to: (i) *Conserve scenic quality* and foster leisure activities that rely on *natural* scenery and not on man made activities, and provide for the sustainable usage of the coast for public enjoyment and recreation, (ii) *Conserve/protect/enhance*

---

<sup>1</sup> Corresponding author: Bartın University, Department of Landscape Architecture, 74100, Bartın, Turkey. [canancengiz@bartin.edu.tr](mailto:canancengiz@bartin.edu.tr)

<sup>2</sup> Bartın University, Department of Landscape Architecture, 74100, Bartın, Turkey. [bcengiz@bartin.edu.tr](mailto:bcengiz@bartin.edu.tr); [bulent\\_cengiz@yahoo.com](mailto:bulent_cengiz@yahoo.com)

the coastal environment and foster awareness and understanding of conservation. (iii) Maintain and improve community involvement, and (iv) *Identify the finest* stretches of undeveloped coast [7].

In order to determine the general understanding of geodiversity and geoconservation, a case studies the Giant's Causeway and Causeway Coast World Heritage Site in Northern Ireland and Fingal's Cave in Scotland are presented. These two examples serve as models for Coastal Landscape Heritage Project.

### **The Giant's Causeway and Causeway Coast World Heritage Site**

The Giant's Causeway and Causeway Coast World Heritage Site has an area of 71 ha and occupies a thin, approximately 5-km-long strip of mainly coastal cliff, between Causeway Head and Benbane Head on the north coast of County Antrim in Northern Ireland. The Giant's Causeway and Causeway Coast were designated a World Heritage Site by UNESCO in 1986 due to its outstanding geological and natural features [8].

The property's accessible array of curious geological exposures and polygonal columnar formations formed around 60 million years ago make it a 'classic locality' for the study of basaltic volcanism. The features of the Giant's Causeway and Causeway Coast site and in particular the strata exposed in the cliff faces, have been key to shaping the understanding of the sequences of activity in the Earth's geological history [8].

Most of the 70 ha site is in the ownership and management of the UK National Trust. Access to the coast is by a system of footpaths which allow visitors the opportunity to view the coastal scenery from the cliff tops and also examine the geological features at close range. The path is generally unobtrusive, and monitored and maintained to keep it in a safe condition. The cliff exposures and causeway stones, key attributes of the property, are protected by ownership in perpetuity by The National Trust. The removal of 'souvenir' stones from the Causeway, which occurred before the area was protected, has long since ceased [8].

The Giant's Causeway and Causeway Coast World Heritage Site is one of the most popular tourist attractions in Northern Ireland [6: 9] with over 750,000 people visiting each year (based on Northern Ireland Tourist Board 2008 visitor numbers) [6].

### **Fingal's Cave**

Fingal's Cave is a natural sea level cave on the uninhabited island of Staffa, in the Inner Hebrides of Scotland, and has been designated a National Nature Reserve. It is formed from jointed basalt columns similar in structure to the Giant's Causeway and to those of nearby Ulva Island, all part of the same ancient lava flow. Its size configuration amplify the sounds produced by waves and are said to give it the atmosphere of a natural cathedral [9].

In this notice, the landscape potential of Güzelcehisar Lava Columns has been presented and compared with the examples in the world. Strategic suggestions have been developed for Lava Columns to be utilized in a sustainable tourism oriented way as a coastal geological heritage area.

## **2.MATERIALS AND METHODS**

Güzelcehisar, which has been chosen as a research area, is within the provincial borders of Bartın located. It is a natural bay in the west of and 17-km away from Bartın city center (Fig. 1). Güzelcehisar Bay is a First Degree Archaeological Site (Güzelcehisar Castel), and First Degree Natural Protected Area. First Degree Archaeological Site has 1.57 ha usage area, and First Degree Natural Protected Area has 15.15 ha usage area which consists two sections as sandy and rocky. It ends with the Lava Columns located at the end of the southern part coastline. First Degree Natural Protected Area involves the whole Güzelcehisar coast [10]. Limited number of dispersed settlements through the area and the forestlands behind them attract attention.



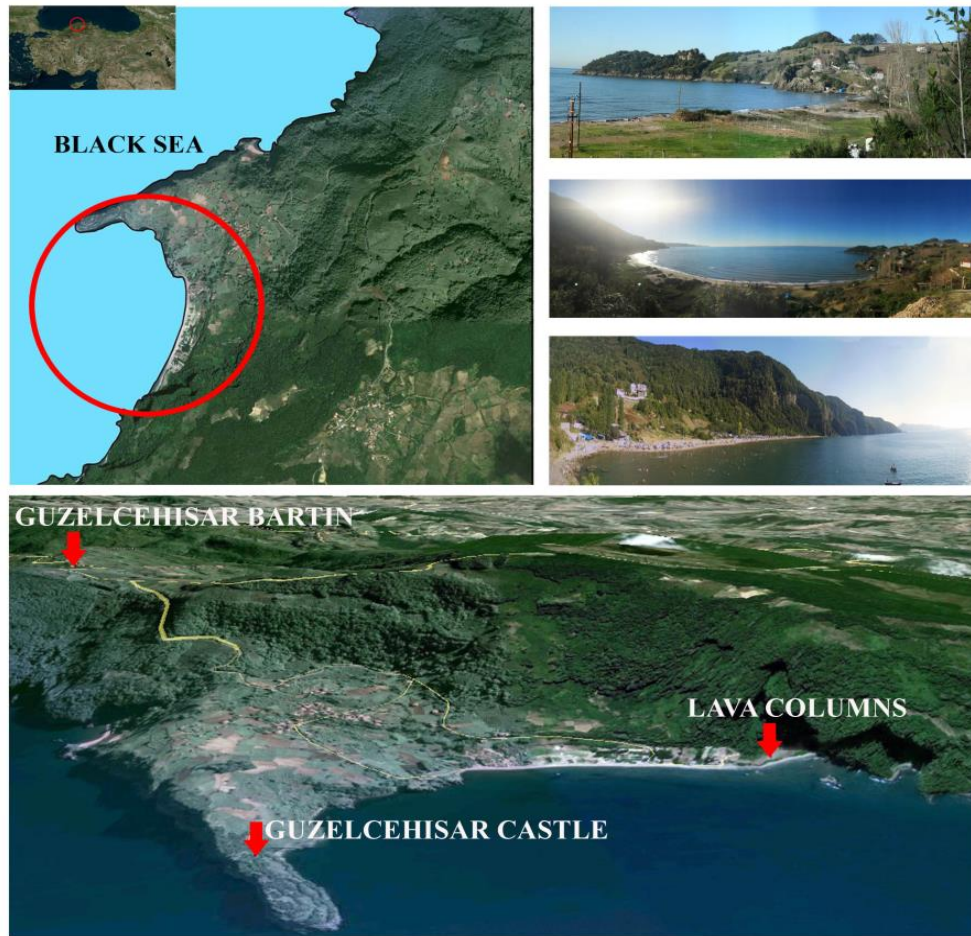

Figure 1. Geographical location of Güzelcehisar Bay.

The method of the notice consists the following stages; i) defining the natural and cultural landscape features related to the research area, ii) presenting the formation and importance of Güzelcehisar Lava Columns, iii) examining the international examples of lava columns, iv) carrying our SWOT analysis to determine the strengths, weaknesses, opportunities, and threats of Lava Columns in terms of accessibility/visibility, tourism and recreational usage, sustainability and rural development, v) presenting the ecological plan strategies for Güzelcehisar, vi) defining the landscape application project design process for Güzelcehisar Lava Columns and applying this process, vii) developing strategies for Güzelcehisar Lava Columns as a coastal geological heritage.

### 3.RESULTS AND DISCUSSION

#### Site Description

Güzelcehisar is a traditional rural coastal settlement area affiliated to Bartın City with mostly preserved natural and cultural values and microclimatic features.

Owing to its natural landscaping features, Güzelcehisar attracts attention with internationally important Lava Columns, natural vegetation cover and natural beach. In this scope, it is an area with high landscaping values that present versatile spatial characteristics. It is a rural settlement adjacent to the forest. With its microclimatic condition, it is one of the few areas in Bartın where citrus can be grown in Black Sea. There are Lava Columns in the southern part and a First Degree Archaeological Site in the northern part of Güzelcehisar Bay. With the Lava Columns, First Degree Archeologically Site is connected to the natural beach which is a First Degree Natural Protected Area. There is a forestland behind this area. Güzelcehisar Bay is a priority region for preservation with its forestland, Lava Columns which are rare formations in the world, First Degree Archaeological Site and First Degree Natural Protected Area.

When land use case is in Fig. 2 is examined, First Degree Natural Protected Area does not vary in terms of space functions. In the area where woodlands are dominant, forestlands, built-up areas, cultivated areas, rocky areas and beach are the primary land use types. During current land use evaluation studies, a few 1-2 storey constructions were detected in First Degree Natural Protected Area. In the First Degree Archaeological Site, there are dense forestlands and rocks and it is surrounded with cultivated areas. Access to the First Degree Archeologically Site is possible through the cultivated areas with an unstable pathway.

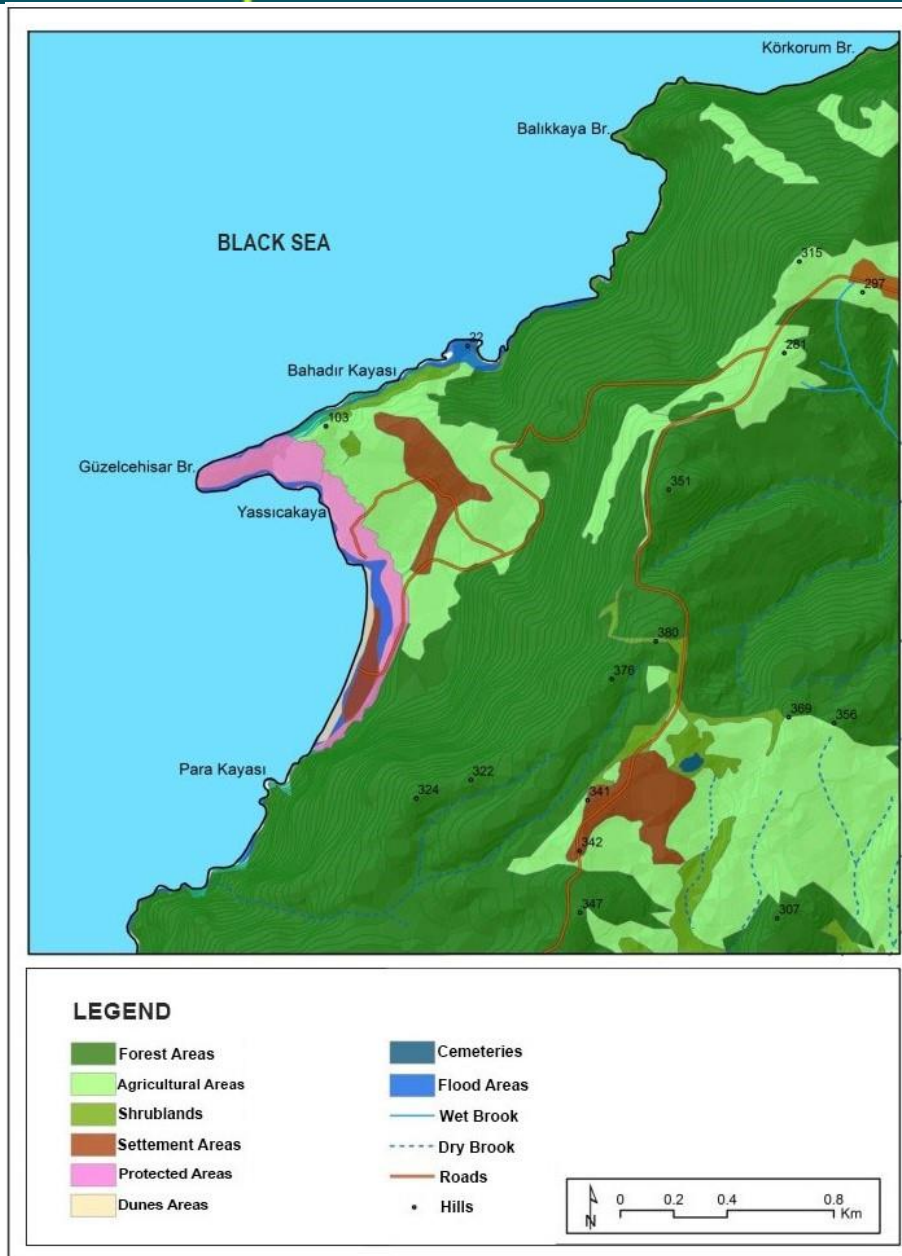
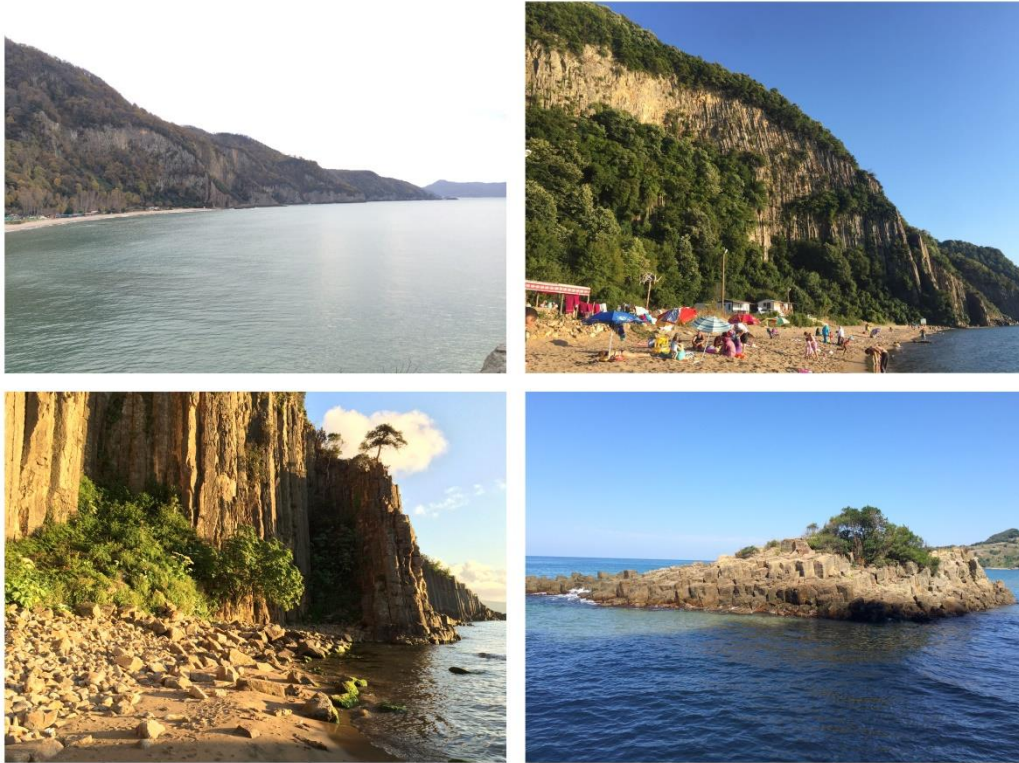

Figure 2. Current land use map of the research area [3].

### Güzelcehisar Lava Columns

Due to its volcanic structure, Güzelcehisar, which stands out with its natural and cultural landscaping features, owns special 80-million-year geomorphologic formations in its coastline which have the characteristic of nature monument called “Lava Columns”. Lava columns, today known as Black Sea mountain rows, were like bows where there were volcanoes. The region was covered with Tetis Ocean. When the bottom of the ocean sank toward north and after both of the bottoms melted in deep in the Earth and erupted at the Earth’s surface, volcano series were formed starting from Bulgaria border extending to Georgia. The lava cooled, crystallized and formed rocks. As it cooled, it contracted as a result of cooling and hardening. The contraction caused stress in the rock. As a natural consequence, cracks were formed and once the crack developed it continued to grow. These smooth geometrical formations which are commonly hexagonal, pentagonal or tetragonal in shape are called “Lava Columns”. The diameters of the lava columns in Güzelcehisar are 50 – 100 cm and their height are above 30 meters (Fig. 3). Güzelcehisar Lava Columns, which are included in the Geological Heritage Inventory Proposals in Turkey, are the rare natural formations in the world [11].



*Figure 3. Güzelcehisar natural beach and lava columns (Original 216).*

### **SWOT Analysis of the Study Area**

SWOT analysis was carried out to determine the current status of the study area. SWOT analysis of Güzelcehisar was given in Table I.

Table 1. SWOT analysis of the study area

	<b>Strengths</b>	<b>Weaknesses</b>	<b>Opportunities</b>	<b>Threats</b>
<b>Accessibility / Visibility</b>	<ul style="list-style-type: none"> <li>• Lava columns that are in the northern part of Güzelcehisar Bay can be seen from the First Degree Archaeological Site</li> </ul>	<ul style="list-style-type: none"> <li>• There is no access to Lava Columns from the land</li> <li>• Lava Columns can only be accessed by sea</li> <li>• Lava Columns continue along the open sea</li> </ul>	<ul style="list-style-type: none"> <li>• There is a rocky island on the sea</li> </ul>	<ul style="list-style-type: none"> <li>• The obstacles resulting from the bad weather conditions that can occur in the open sea</li> </ul>
<b>Tourism and Recreational Usage</b>	<ul style="list-style-type: none"> <li>• Güzelcehisar Bay is a natural beach</li> <li>• The area has an ecotourism potential</li> <li>• It has the characteristic of a rural landscape</li> </ul>	<ul style="list-style-type: none"> <li>• Insufficiency in infrastructure</li> <li>• Insufficiency in advertising</li> <li>• The access to Lava Columns is limited</li> <li>• The public is not conscious enough about ecotourism</li> <li>• Tourism mobility only takes place in summer months</li> </ul>	<ul style="list-style-type: none"> <li>• Güzelcehisar Bay already attracts great attention in terms of sea tourism</li> <li>• Locals earn their living through tourism</li> </ul>	<ul style="list-style-type: none"> <li>• Bearing capacity problems resulting from the intensive usage in summer months</li> </ul>
<b>Sustainability</b>	<ul style="list-style-type: none"> <li>• There is a First Degree Natural Protected Area in Güzelcehisar</li> <li>• There are wide forestlands</li> <li>• The microclimatic effect in Güzelcehisar</li> </ul>	<ul style="list-style-type: none"> <li>• Güzelcehisar Bay has a limited bearing capacity</li> </ul>	<ul style="list-style-type: none"> <li>• Güzelcehisar settlement has a rural identity</li> <li>• Locals earning money through touristic mobility</li> </ul>	<ul style="list-style-type: none"> <li>• Intensive sea tourism</li> </ul>
<b>Rural Development</b>	<ul style="list-style-type: none"> <li>• The Lava Columns are one of the rare formations in the world</li> <li>• The rural identity in Güzelcehisar has the potential of contributing to the rural development</li> </ul>	<ul style="list-style-type: none"> <li>• Insufficiency in infrastructure</li> <li>• Insufficiency in advertising</li> <li>• The public is not conscious enough about rural development</li> </ul>	<ul style="list-style-type: none"> <li>• Local authorities support works about advertising Güzelcehisar Lava Columns</li> </ul>	<ul style="list-style-type: none"> <li>• Inadequacy and contradictions in the current laws and regulations</li> </ul>

## Suggested Ecological Plan Strategies

In the zoning works that took place in the scope of Güzelcehisar Ecologic Plan scaled 1/25.000 prepared by Cengiz et al [3], Lava columns took place in subzone of “Morphologically Important Sites” in “Conservation Zone” (Table II). The aim of the conservation zone is to protect the ecosystems that are sensitive to intensive human activities and their probably damages and to maintain the current area usage and characteristics [1]. In this context, Güzelcehisar Lava Columns, which are offered as Geological Heritage, should have an international protected status in the site.

Table 2. Subzone, ecological criteria and suggestions related to Güzelcehisar Conservation Zone [3].

	<b>Subzones</b>	<b>Ecological Criteria</b>	<b>Suggestions</b>
--	-----------------	----------------------------	--------------------

<b>Conservation Zone</b>	Forest Conservation Areas	<ul style="list-style-type: none"> <li>• Areas with High Forest Density (41%-70%)</li> <li>• Areas with High Forest Density (71%-100%)</li> </ul>	Areas to be evaluated in the framework of current laws and regulations
	Morphologically Important Sites	<ul style="list-style-type: none"> <li>• Natural Beaches</li> <li>• Peak Points</li> <li>• Lava Columns (250 m)</li> </ul>	Areas to be conserved as “Natural Heritage Coastlines” and Scenery Points
	Water Resources Conservation Areas	<ul style="list-style-type: none"> <li>• Stream Conservation Belt (50 m)</li> </ul>	Areas to be offered as Conservation Zone
	Agricultural Quality Conservation Areas	<ul style="list-style-type: none"> <li>• Existing Cultivated Area</li> <li>• Closeness to Active Water Resources</li> </ul>	Areas to be offered as “Agricultural Site”
	Areas with Conservation Status	<ul style="list-style-type: none"> <li>• Archeological Sites (0-100 m)</li> <li>• Natural Protected Areas (0-100 m)</li> </ul>	Tourism and Recreation Areas with Conservation status

Integrative plan decisions are developed peculiar to Güzelcehisar in the scope of Güzelcehisar Ecologic Plan scaled 1/25.000 prepared by Cengiz et al [3] based on the necessity that all the landscaping elements of Güzelcehisar should be handled as a whole. These are:

Conservation potential of the research area is high as it has natural beaches, lava columns, dense plant cover peculiar to Black Sea, citrus gardens and olive groves. The agricultural landscape created by the citrus gardens and olive groves is an important element of the rural characteristic. These existing areas have been offered to be as “Agricultural Protected Area” in the scope of ecological plan. In order to maintain the sustainability of rural characteristic in Güzelcehisar, it is important to develop the agricultural pattern in the whole land.

One of the most important oppressions on the research area is that it is used intensively in the summer months and it exceeds its bearing capacity. Besides, as Güzelcehisar is a natural beach, the people living around prefer it for camping and excursions. As a result, there is an intensive population in the summer months. In the framework of ecological plan, plans peculiar to the area have been developed in order to solve existing problems.

The research area is a rural settlement that is located among Archaeological Site, Natural Protected Area and forestland. That is why, improvement works aimed at rural settlement fabric should be carried out by taking the topography and the existing characteristic into consideration. Also, new settlement areas should be planned in line with the ecological plan decisions.

Güzelcehisar, which stands out with its rural characteristic, is important in terms of rural tourism potential with its geomorphologic formations, coast line, natural beach, forestlands, microclimatic features, citrus gardens and olive trees. As the climate is appropriate for tourism, spreading alternative tourism activities throughout the year will contribute to the rural development.

In the research area, it is offered to plan controlled forest recreation areas for the forest conservation areas and areas with high forest density. In this context, in the framework of the ecological plan, it is suggested to direct the density in the coastline to the forestlands in accordance with ecological transfer capacity as a suggestion to increase recreational variety in the area.

Since the research area is a peninsula, it has the characteristic of Coastal Morphology Conservation Area. In this scope, in the framework of the ecological plan, lava columns are suggested to be “National Geologic Heritage”.

However, water, sewer system, electricity, transportation, car park and accommodation problems of Güzelcehisar Coastline have not been solved yet. The inefficient infrastructure of the beach cannot bear the seasonal tourist population and it is inefficient in providing service. Apart from the touristic season, the population is 939, but this number rises to 5000-6000 in summer. According to the inhabitants, the infrastructure is used excessively in busy period, the service quality decreases and thus, dissatisfactions arise. The inadequacy of transportation on village roads and rural area affects tourism negatively. In the region that is located in a place where transportation is difficult, the development of tourism sector is mostly related to the adequacy of transport facilities. Maybe the needs and problems of the area will not be solved altogether, but solving the infrastructure problems in the long run with this project is highly important in terms of regional development.

### **Landscape Design Process Aimed at the Solution of Existing Problems**

In Turkish Tourism Strategy 2023, planing, investment, organization, service quality, improving transportation and infrastructure, diversifying tourism, etc. have been set as 5-year development plan aims.

In this scope, based on the field work carried out in the light of the data gathered from the comparison of Güzelcehisar Ecologic Plan scaled 1/25.000 prepared by Cengiz et al [3] with the Güzelcehisar Construction Plan scaled 1/1.000-1/5.000 prepared by

Bartın Provincial Special Administration [10], the things that should be done for Güzelcehisar at the first stage have been detected. A landscape application project has been developed where access to lava columns is possible throughout the land, the tourism and recreational activity infrastructure in the coastline is developed and coastal landscaping with rural characteristic is maintained. In order for this project to be applied in stages, with the coordination of Bartın University, Bartın Provincial Directorate of Culture and Tourism and Bartın Provincial Special Administration, in the framework of Western Black Sea Development Agency 2016 Small Scaled Infrastructure Financial Support Program, a project application is prepared entitled "Touristic and Recreational Landscape Application Project of Bartın Güzelcehisar Lava Columns and Coastline". In the scope of the project, a wooden platform road that will start with the view terrace on First Degree Archaeological Site on the north side of Güzelcehisar Bay and that will go alongside the beach is connected to a rocky island on the sea and access to the Lava columns in the southern part of the Bay.

The general aim of the project is to carry out physical and social infrastructure works in order to develop tourism in the regions which have natural, historical and cultural potentials. The special aims to carry out this general aim are as follows:

1. Building a 70-m<sup>2</sup> pier on the sea: Pier on the sea, which is a part of tourism and recreation activities in Güzelcehisar coast, will give the opportunity to domestic and foreign tourists to view the Lava columns. Besides, this pier will be wooden which has a multipurpose usage.
2. Constructing a 300-m<sup>2</sup> Walking Platform on the Island: A wooden platform will be constructed on the island for the domestic and foreign tourist to walk comfortably.
3. Making a 290-m<sup>2</sup> Festival Area on the Beach: In order to promote lava columns nationally/internationally, it is planned to organize traditional Lava Columns Festival on Güzelcehisar Beach.
4. Constructing a 290-m<sup>2</sup> View Terrace on the Beach: A View Terrace will be constructed in order for domestic and foreign tourists to view the Lava Columns in Güzelcehisar landscape.
5. Constructing a 850-m long and 3-m wide Walking Trail on the Beach: In order to provide access and promote Lava Columns on Güzelcehisar Beach, a wooden Walking Track will be constructed to provide comfortable access between Walking Island-Festival Area-Viewing Terrace which will not hinder beach usage.
6. The tourism conscious and human resources in the region will be raised.
7. Advertising materials (advertisement brochure, introductory booklet, project informing boards, 306 degrees virtual tour, Web Site, Short Film Shooting) will be prepared.
8. The public will be educated by experts in order to gain ecotourism consciousness.
9. Participations to International Fairs will be provided to advertise the region.
10. Workshops will be organized with Bartın University on scientific topics such as Landscape Architecture, Forest, Archeology, Ecology, Geology, Tourism and Social Sciences.
11. A Technical Tour will be organized to Giant's Causeway and Causeway Coast UNSECO World Heritage Site in Northern Ireland Antrim Region.

#### 4.CONCLUSIONS

As a general result, rural landscapes have importance in pass sustainable environment on to the next generations. These areas are like buffer zones between urban and natural areas. In these areas, the local culture that exists in the daily life of the public reflects the rural characteristic of the region. The alternative tourism activities in rural places where the culture is alive and experienced and the opportunity for the locals in Güzelcehisar to market the local products will provide sustainable rural development and economic growth in the research area. In Bartın, with its coastal settlement features, Güzelcehisar, which reflects the landscaping characteristic on a local scale, is a priority region for preservation that will be evaluated to be Agricultural Site and National Geological Heritage Area where archeological works should be continued. Besides preservation, it carries a potential for agroforestry and agricultural tourism activities.

Due to the outstanding landscaping features, Güzelcehisar Lava Columns and Coast have the potential to be in UNESCO World Heritage List as we can see in The Giant's Causeway and Causeway Coast World Heritage Site example. With the participation of the public and public support, UNESCO membership process should be started immediately to register this potential.

#### REFERENCES

- [1] C. Cengiz, Kıyı Alanlarında Ekolojik Planlama: Yalova-Armutlu Örneği. Doktora Tezi (basılmamış), Ankara Üniversitesi Fen Bilimleri Enstitüsü Peyzaj Mimarlığı Anabilim Dalı, Ankara, 2009.
- [2] Z.G. Kayır, Çevre Korumaya Ekolojik Yaklaşım: Dalyan Örneği. Doktora tezi (basılmamış), Mimar Sinan Üniversitesi Sosyal Bilimleri Enstitüsü Sosyoloji Anabilim Dalı, Kurumlar Sosyolojisi Programı, İstanbul, 1994.
- [3] C. Cengiz, B. Cengiz, B. Bekci ve D.A. Tekdamar, Bartın Güzelcehisar Kıyı Yerleşiminin Ekolojik Planlaması, Bartın Üniversitesi Bilimsel Araştırma Projesi, Kapsamlı Araştırma Projesi, BAP-2011-2-26, Bartın, 2015.
- [4] M. Stanley, *Geodiversity*, Earth Herit., 14:15-19, 2000.
- [5] C.V. Burek, and C.D. Prosser, The History of Geoconservation: an Introduction. In: Burek CV, Prosser CD (eds) The History of Geoconservation. The Geological Society special publications 300. The Geological Society, London, pp 1-5, 2008.

- [6] K.R. Crawford and R. Black, *Visitor Understanding of the Geodiversity and the Geoconservation Value of the Giant's Causeway World Heritage Site, Northern Ireland*, *Goheritage*, 4:115-126, 2012.
- [7] A.T. Williams, V. Sellers, and M.R. Philips, *An Assessment of UK Heritage Coasts in South Wales: J A Steers revisited*, *Journal of Coastal Research*, Special Issue 50 (Proceedings of the 9th International Coastal Symposium), 453-458. Gold Coast, Australia, 2007.
- [8] UNESCO 2016, <http://whc.unesco.org/en/list/369/>.
- [9] M.J.M. Cooper, *The Giants Causeways and Fingals Cave, Volcanic Tourist Destinations*, 2014.
- [10] Anonim, *Bartın Güzelcehisar I. Derece Arkeolojik Sit Alanı Koruma Amaçlı 1/5000 Ölçekli Nazım ve 1/1000 Ölçekli Uygulama İmar Planı Araştırması ve Plan Açıklama Raporu*. Bartın İl Özel İdaresi, Türkiye, 2011.
- [11] M. Altaş, A. Yaylı, R. Kahramanoğlu, İ. Aktaş ve Ç. Asma, *Mitolojiden Gezgine Bartın*. Bartın İl Kültür ve Turizm Müdürlüğü Yayını, Ankara, Türkiye, s. 145-152, 2007.

# A Spatial Analysis Of A Traditional Street In Amasra, Turkey

*Bulent Cengiz<sup>1</sup>*

---

## **Abstract**

*Historically, culturally, and architecturally rich ancient city fabrics have important heritage qualities in terms of urban identity and sustainability. Pedestrian zones, which are based on pedestrian comfort and facilitate perceiving cultural heritage in historical city centers on the pedestrian scale, are of particular importance for urban design. Besides its natural beauties, the city of Amasra is a residential area located on a peninsula with historical and cultural features in the Western Black Sea Region. As a 3,000 year old ancient coastal town close to big cities such as Istanbul and Ankara as well as the Kastamonu-Bartın Küre Mountains National Park and Safranbolu, Amasra has a high potential for tourism. By 2013, the Castle of Amasra was included on UNESCO's World Heritage Tentative' List as a trading post and fortification on the Genoese trade route from the Mediterranean to the Black Sea. Having been selected as a study area, Çekiciler Bazaar's pedestrian zone is Amasra's most commercially and touristically important landmark which reflects the traditional city fabrics. The main purpose of the study is to determine the role of Çekiciler Bazaar, which is a historical market and has traditional Turkish settlement characteristics, in downtown Amasra. This study used local, natural environment and built environment analyses. The data obtained were analyzed using SWOT analysis. As a result, this study developed suggestions based on landscape design principles for Amasra's Çekiciler Bazaar.*

**Keywords:** *Amasra, traditional street, pedestrian space, historic urban landscape, urban design, bazaar*

---

## **1.INTRODUCTION**

Streets and squares were the liveliest spots in cities in the old times where people came together and carried out various social, cultural and commercial activities [1]. Vehicle use was secondary in the Middle Ages. Land slope was taken into consideration while building the roads [2, 3]. Historic town are the outcomes the physical, social, cultural, economic a land technological conditions of a period or periods, which ave created them. In time due to the changes in the condition effective in their formation, most of them become subject to change, negligence or destruction.

As a result, while losing their character and values, they are disintegrated from the existing urban environment [4]. Managing mobility is one of the main challenges faced by historic cities [5]. Pedestrian is a person who walks around urban space or moves with the help of his/her wheelchair in case he/she is a disabled individual [6]. Pedestrian regions are important urban works that are carried out to revive the parts of the urban center to make economic and social life more rational, active and lively with transportation services and commercial efficiency [7]. The Pedestrian zone is the primary component of every street in a city [8]. According to the Dumitrescu and Blidariu [9], Pedestrian safety is greatest when vehicle speeds are low or when vehicles are banned altogether. Pedestrian malls are car-free zones within cities where street scape is reserved for pedestrian use [10, 11]. These areas generally include a range of retail, residential, and office activity and a mix of land use patterns [12]. These areas were centrally based in the city centre and were a great meeting place for residents and a hub for cultural activities [13]. According to the Rubeinstein [14] pedestrian malls can be classified in to three main types. These are:

**Full Mall:** A full mall is obtained by closing a street that was formerly used for vehicular traffic and then improving the pedestrian street or linear plaza with new paving, street trees, street furnishing, and other amenities such as sculpture and fountains.

**Transit Mall:** A transit mall or transitway is developed by removing automobile and truck traffic on an existing principal retail street and allowing only public transit such as buses and taxis or light rail in the area.

**Semimall:** In the semimall the amount of traffic and parking is reduced.

Pedestrianization is transforming an urban space containing one or more roads into spaces used only for pedestrian traffic by shutting them off to motorized traffic apart from service vehicles that can enter the area only during certain times of the day [6]. Pedestrianization is a result of the negative impacts of modern life such as traffic problem, air and noise pollution as well as social and cultural interaction. Pedestrianization applications carried out especially in historical centers create physical, functional, social, cultural and economic changes in social life [15]. The simplest meaning of it is the removal of vehicular traffic from city streets [16]. The aim of pedestrianization in historical urban centers is to meet the demands for preserving the historical texture, increasing the attractiveness, creating centers of attraction suited to the urban identity and creating spaces that are far from the negative impacts of traffic while making positive contributions to the city via various activities [11, 15].

---

<sup>1</sup>Corresponding author: Bartın University, Department of Landscape Architecture, 74100, Bartın, Turkey. [bcengiz@bartin.edu.tr](mailto:bcengiz@bartin.edu.tr); [bulent\\_cengiz@yahoo.com](mailto:bulent_cengiz@yahoo.com)



Having been selected as a study area, Çekiciler Bazaar's pedestrian zone is Amasra's most commercially and touristically important landmark which reflects the traditional city fabrics. The main purpose of the study is to determine the role of Çekiciler Bazaar, which is a historical market and has traditional Turkish settlement characteristics, in downtown Amasra. This study used local, natural environment and built environment analyses. The data obtained were analyzed using SWOT analysis. As a result, this study developed suggestions based on landscape design principles for Amasra's Çekiciler Bazaar.

## 2.MATERIALS AND METHODS

Amasra is located in the Black Sea region of Turkey at 41°44'58"N 32°23'11"E. The population of Amasra City is about 6,500. By 2013, the Castle of Amasra was included on UNESCO's World Heritage Tentative List as a trading post and fortification on the Genoese trade route from the Mediterranean to the Black Sea. Having been selected as a study area, Çekiciler Bazaar's pedestrian zone is Amasra's most commercially and touristically important landmark which reflects the traditional city fabrics [17].

The objective and goals of spatial analyses, evaluations and design proposals related to the study area are summarized in Table I. The analyses carried out related with the pedestrian zone spatial design proposals for the Amasra traditional urban texture are handled under 3 main headings (Table II).

Direct observations and investigations carried out in the study area, photographs taken, previous scientific publications as well as the 1/1000 scale development plan for protection were used to determine the historical, cultural and natural properties of the study area. Spatial analyses of the study area were mapped in the light of the data acquired as a result of observations and investigations carried out. Autocad 2014 and Photoshop Cs5 software were used to generate the maps.

SWOT analysis was carried out to determine the current status of Çekiciler Bazaar. The study area and pedestrian spaces were examined within the framework of design and planning principles, shortcomings were determined and relevant proposals were developed.

Table 10. Objective and goals of spatial analyses, evaluations and design proposals related to the study area [11]

	<b>Spatial Analysis</b>	<b>Evaluation</b>	<b>Design Proposals</b>
<b>Objective</b>	Determining the importance, current land use and originality of spatial	Evaluation of the pedestrian spaces with regard to design criteria in accordance with the Amasra urban identity via location analysis, built environment analyses, and SWOT analysis was carried out to determine the current status of Çekiciler Bazaar.	Development of pedestrian region proposals at Çekiciler Bazaar of Amasra in the light of design criteria and identity elements
<b>Goal</b>	Determination and adaptation of the spatial character specific to the region	Determination of the interaction of design applications with the environment, reasons for preference, basic problems of the pedestrian space and the deficiencies	Providing integration of design proposals to the applications related with the problems and deficiencies determined

Table 2. Spatial analyses and evaluation indicators for the study area [11]

<b>Analyses</b>	<b>Evaluation Indicators</b>
Location Analysis	Identification of boundaries
	History
	Spatial relationship with its environs
Built Environment Analysis	Analysis of the Castle Wall Junction in the Pedestrian Space
	Registered Structure Analysis in the Pedestrian Space
	Analysis of Pedestrian Entrance Points to Çekiciler Bazaar
	Livability of the Current Buildings
	Analysis of the Materials Used in the Buildings
	Analysis of the Floor Heights in the Pedestrian Space
	Analysis for the entrance points of structures in the Pedestrian Space

## 3.RESULTS AND DISCUSSION

### Location Analysis

Çekiciler Bazaar is located in Amasra sections of Bartın (Fig. 1). In this section, the current situation of pedestrian zone of Çekiciler Bazaar is evaluated and it is also evaluated in terms of pedestrian vehicle traffic, pedestrian walk, shuttles, public services, current structures, equipment members, botanical texture criteria. As woodworking is common in this region, this street is called "Çekiciler".



Figure 24. Location of the Study Area.

The discussed pedestrian zone is a historical bazaar that is used intensely by domestic and foreign tourists for shopping who come to the region especially for sea tourism. The pedestrian zone is very busy on Saturdays and Sundays since the number of tourists coming to Amasra increases especially in summer months and at the weekends. The absence of pedestrian way in pedestrian zone affects the unity of the pedestrian zone positively. The floor covering material of Çekiciler Bazaar is paving stone and the rain water control is maintained with rain gutter in the middle of the road.

The study area is closed off to vehicle traffic completely and is classified as (Full Mall) pedestrian walkway. In the entrance of Çekiciler Bazaar, passage of vehicles is prevented by using delineators as barriers.

### Built Environment Analysis

Çekiciler Bazaar is 145 meters long and its width changes between 3.30 meters and 5.90 meters. With its feature on human scale, it is one of the examples of traditional Turkish settlement characteristic.

In the study area, there is a historical structure intended for locals, domestic and foreign tourists. In the area, there is Amasra Castle, Castle Walls, and buildings which are architecturally and historically important [17-18]. Apart from these, there are many cafés, souvenir shops, boutiques, etc. With all these features, the area is an important shopping and tourism center in Amasra. During its 3000 years of history, Amasra has hosted many civilizations. Since the city has a small surface area, each civilization built its city on the other.

In Amasra, 68 inventories are registered and they have a protected status. There are no registered buildings in the study area, but there are 5 registered buildings in the immediate surroundings. The most important of the registered buildings are Castle Walls. Castle Walls from Genoese are registered buildings that attract many tourists to this area. There is Ethem Ağa Mansion, District Governorship Lodging, Ali Uysal House, Small Church and two registered housings (Fig. 2a).

It is possible to reach Çekiciler Bazaar pedestrian zone from Küçük Liman Street, Zeki Çakan Street and General Mithat Ceylan Street. These streets can be used by vehicles, but Çekiciler Bazaar pedestrian zone is closed to traffic. There are pedestrian junctions from Çekiciler Bazaar to Amasra Castle (Fig. 2b-2c).

In Amasra city construction plans, structuring conditions are planned for at most 5-storey buildings. In the study area there are at most 4-storey buildings. There are totally 59 buildings in the study area. 5 of these are 1-storey (8%), 11 of these are 2-storey (19%), 8 of these are 3-storey (14%) and 35 of these are 4-storey (59%) buildings (Fig. 3a).

In Amasra, ferroconcrete, masonry, wooden and prefabricate structures are used as construction production technique. The material used in the constructions in the study area are wooden and ferroconcrete. 55 of these are ferroconcrete (93%) and 4 of these are wooden (7%) constructions (Fig. 3b).

When the construction quality in Amasra is analyzed, it is seen that there are constructions in good, moderate, poor conditions and there are also ruins. In the study area, there are 15 buildings in good condition (25%), 44 buildings in moderate condition (75%), and there are no ruins or buildings in poor condition (Fig. 3c).

In Çekiciler Bazaar pedestrian zone, 42 of the buildings are used as guesthouses (71%) and 17 are used as houses (29%). The ground floors of the current buildings are used as shops (Fig. 3d and Fig. 4).



Figure 2. a. Registered Structure Analysis near the Study Area b. Junctions that will Provide Access from the Study Area to Amasra Castle, c. Pedestrian Entrance Points (Original 2016).

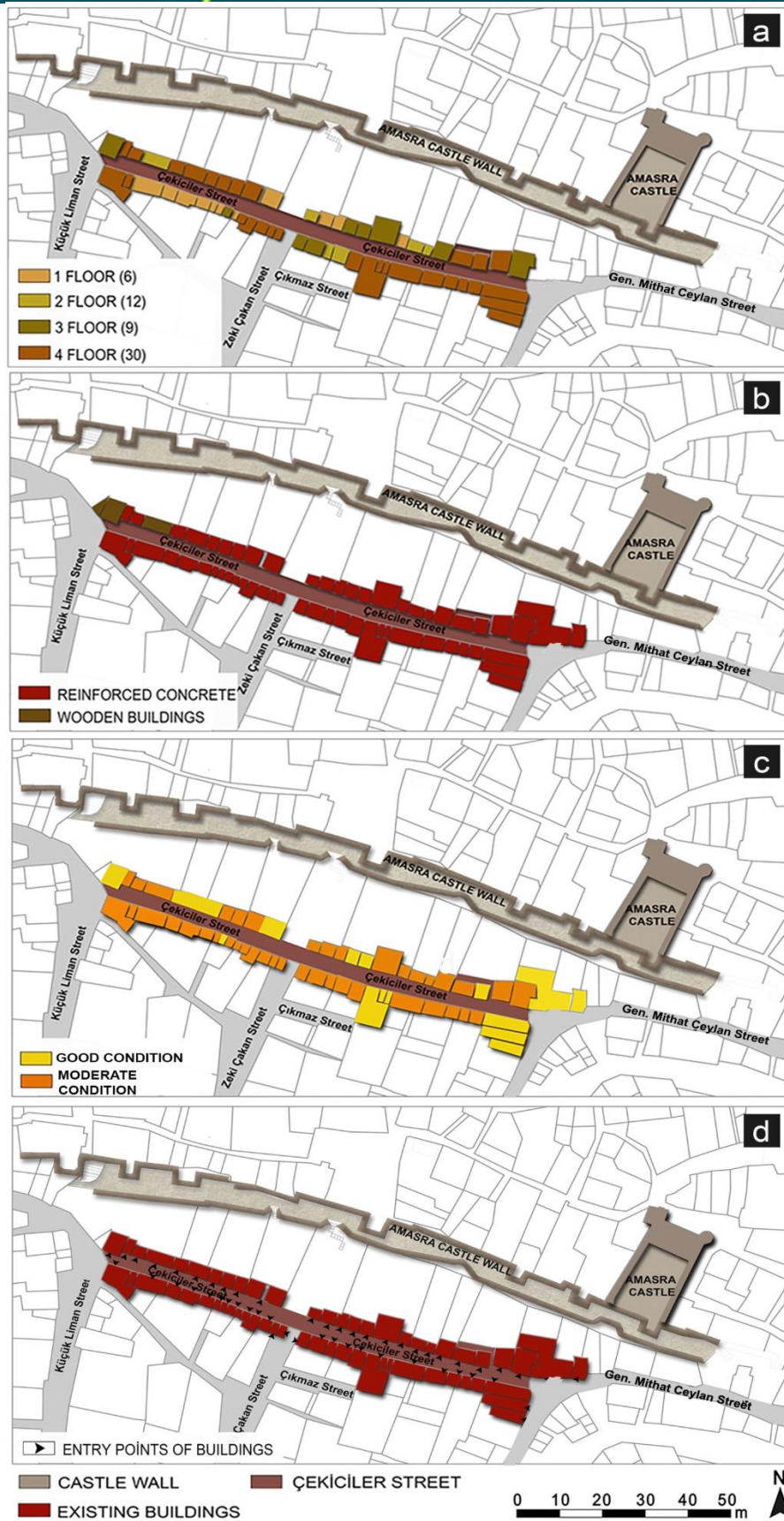

Figure 3. a. Storey Height Analysis around the Study Area, b. Construction Production Techniques used in the Current Structures around the Study Area, c. The Quality of the Structures in the Study Area, d. The Entrance Points of the Structures around the Pedestrian Zone (Original 2016).



Figure 4. Sales stands of the traditional handicrafts shops (Original 2016).

### Swot Analysis of the Study Area

SWOT analysis was carried out to determine the current status of the study area. SWOT analysis of Çekiciler Bazaar was given in Table III.

Table 3. SWOT analysis of the study area

	Strengths	Weaknesses	Opportunities	Threats
Physical Structure	<ul style="list-style-type: none"> <li>•Being a center of attraction for the tourists.</li> <li>•Being in Amasra historical urban fabric</li> <li>•Historical fabric attracting tourists</li> <li>•Pedestrian junction connecting the Big Port to the Small Port</li> <li>•Availability of the shops selling traditional handicrafts</li> <li>•Being able to reflect the cultural identity of Amasra</li> </ul>	<ul style="list-style-type: none"> <li>•Lack of harmony in the frontal surface of the structures in the area</li> <li>•Non-uniformity and neglected state of the sunshades and stands of the shops in the Bazaar</li> <li>•Width of the road is not enough</li> </ul>	<ul style="list-style-type: none"> <li>•Historical urban fabric</li> <li>•Active Tourism</li> <li>•The historical value of the registered structures near the study area are kept alive by the restoration works</li> </ul>	<ul style="list-style-type: none"> <li>•Sea pollution</li> <li>•Selling imported goods in souvenir shops and decrease in the production of the traditional handicrafts</li> <li>•Deterioration in the cultural identity of Amasra due to irregular and multi-storey structuring</li> <li>•Human oppression on Amasra Castle</li> </ul>
Social Structure	<ul style="list-style-type: none"> <li>•It is parallel to Amasra Castle Walls and there is a pedestrian junction to the castle</li> <li>•It is a trade center</li> <li>•It provides opportunity for people to socialize</li> <li>•It is on human scale and it is a transition area as a pedestrian zone</li> </ul>	<ul style="list-style-type: none"> <li>•Not suited for bicycle use</li> <li>•Street furniture elements used not in accordance with traditional street texture</li> <li>•Unkempt resting areas</li> </ul>	<ul style="list-style-type: none"> <li>•Being close to Bartın city center and the easy access into the city</li> <li>•Local community earning money from tourism</li> </ul>	<ul style="list-style-type: none"> <li>•Pressure that might be formed on the cultural identity due to intensive tourism</li> </ul>
Economic Structure	<ul style="list-style-type: none"> <li>•Providing for shopping, recreation, resting etc.</li> <li>•The city is an important center for tourism</li> <li>•An important center for gathering and dispersing inside the bazaar</li> </ul>	<ul style="list-style-type: none"> <li>•Sales stands of shops cause the pedestrian paths to become narrower</li> <li>•Çekiciler Bazaar having limited bearing capacity in terms of spatial size and usage</li> </ul>	<ul style="list-style-type: none"> <li>•Providing employment to the inhabitants</li> <li>•Richness of the forests and woodworking in the region</li> </ul>	<ul style="list-style-type: none"> <li>•Changing consumption habits</li> </ul>

Management and Organisation	<ul style="list-style-type: none"> <li>•Amasra is a member of Turkish Association of Historical Towns</li> <li>•Amasra's inclusion in UNESCO's World Heritage Tentative List</li> <li>•With its architectural heritage, Amasra is a member of the Norwich-based European Association of Historic Towns and Regions</li> </ul>	<ul style="list-style-type: none"> <li>•Insufficient control of applications that does not match the historical pattern building rule which is objected in zoning plan</li> </ul>	<ul style="list-style-type: none"> <li>•Being a model for organizations related to the sustainability of the traditional handicrafts</li> </ul>	<ul style="list-style-type: none"> <li>•Inadequacy and contradictions in the current laws and regulations</li> </ul>
-----------------------------	---	---	---	--

## 4.CONCLUSIONS

During works aimed at transportation in the historical city centers, the authentic fabric had been neglected for a long time. While solving the problems about transportation, enlarging the roads and opening new roads were the primary goals. As a result, the historical fabric being shaped in accordance with the pedestrian mobility, faced with losing its authentic characteristic due to the increase in the number of vehicles and rapid functional transformation. In order to decrease the development oppression on the historical urban fabrics, provide the traditional fabric to be protected and transfer them to the next generations, we should give priority to pedestrian designs.

In accordance with the data gathered from the field surveys, some deficiencies were detected that hinder the harmony of the equipment and materials used in pedestrian zones with the historical fabric and that make it difficult for the users to walk in the area. Since the pedestrian zone is inefficient in terms of road width, shop stands and pedestrian circulation, it is not sufficient to build new areas of usage for the pedestrian zone. That is why making landscaping designs in the entrance of the pedestrian zone is important in terms of enabling people to walk in the area easily. In the structures on the roadsides that provide access to the pedestrian zone, frontal planning, improvement activities related to street furniture and floor materials should be carried out and these should be generalized around the research area. Sales materials that occupy the road should be removed in order to reduce visual pollution and enable the pedestrians to walk in the area uninterruptedly/without hindrance. The elements that affect particularly the vision of the historical Amasra Castle and the Castle Walls negatively should be prevented. The materials used in billboards, street furniture, and selling spaces cause visual pollution in the research area, so these should be in harmony with each other and with the historical environment. The paving stones preferred instead of cobblestones that reflect the traditional Turkish street fabric do not comply with the historical environment. Plant baskets should be used in the area and provide an aesthetic look. The billboards of the shops and the street furniture in the pedestrian zone should not hinder pedestrian circulation and the sunshades should be in the same color to be in harmony. In the pedestrian zone, cobblestones that are in harmony with the area should be used instead of paving stones. The authentic street view of the area will be protected, the coatings made later will be removed and transformed into authentic coverings, damaged and lost parts should be completed with the same technique and materials.

In conclusion, the study area is a frequent destination of the domestic and foreign tourists and it is historical place that is worth protecting. Instead of the interferences made by neglecting the historical fabric that can cause the city to lose its cultural features, designs and adjustments that match with the identity of the area should be carried out. For this purpose, pedestrian zones that are in harmony with Amasra's historical and touristic identity, tiling materials, street furniture and botanical elements should be rearranged in accordance with the user requirements and aesthetic needs. In this scope, maintaining the continuity of Çekiciler Baazar's pedestrian zone characteristic and its popularization throughout Amasra should be taken into consideration in urban design applications.

## 5.REFERENCES

- [1] A. Yıldırım, "İstanbul'da Yayalaştırma Projelerinin Farklı Kullanıcı Grupları Üzerinde Yarattığı Etkilerin Karşılaştırmalı Analizi," Yüksek Lisans Tezi, Yıldız Teknik Üniversitesi. Fen Bilimleri Enstitüsü, Şehir Bölge Planlama Anabilim Dalı, İstanbul, 2007.
- [2] H. Perçin, O. ve Yılmaz, *Yaya Bölgeleri*, Peyzaj Mimarları Odası Yayınları, 2001/1, Ankara, 2001.
- [3] Ü. Demir, "Peyzaj Tasarımında Yaya Bölgeleri Antakya Hürriyet Caddesi Yayalaştırma Örneği," Yüksek Lisans Tezi, Mustafa Kemal Üniversitesi. Fen Bilimleri Enstitüsü, Peyzaj Mimarlığı Anabilim Dalı, Hatay, 2008.
- [4] P. Aykaç, M. N. Rıfaioğlu, A. G. Bilgin Altınöz, and N. Şahin Güçhan, "Design Interventions As Regenerators In Historic Towns: Proposals For Ayvalık Historic Depots Region," The Urban Project, Architectural Intervention In Urban Areas, pp. 24-32, 2009.
- [5] M. Pazos Otón, and L. González, "Mobility Management In A Historical And Tourist City: The Case Of Santiago De Compostela (Spain)," The Overarching Issues Of The European Space. Ed. Faculdade Letras Universidade Do Porto, pp. 237-267, 2013.
- [6] H. Kaplan, ve A. Acuner, *Ankara'da Yayalaştırma Sorunsalı: Yaya Alanlarının Yasal Çerçeve Ve Yerel Yönetimlerin Rolü Kapsamında Değerlendirilmesi*, Planlama 2005, 4 (34), pp. 112-123, 2005.
- [7] F. Yalçinkaya, "Ankara-Bahçelievler Aşkabad Caddesi'nin (7. Cadde'nin) Yayalaştırılmasının Peyzaj Mimarlığı Açısından İrdenilmesi," Yüksek Lisans Tezi, Ankara Üniversitesi. Fen Bilimleri Enstitüsü, Peyzaj Mimarlığı Anabilim Dalı, Ankara, 2007.
- [8] S. S. Bhagat, M.L. Patel, and P.S., Shah, *Pedestrian Priority in Urban Area and Usefulness Towards Community*, International Journal of Research in Engineering and Technology, 03 (01), pp. 526-530, 2014.
- [9] C. Dumitrescu, and C. Blidariu, *Protection of the Built Fund in the Fortress District and Its Revitalisation Based on the Closure of the Traffic Ring II*, Journal of Environmental Protection and Ecology, 14 (2), pp. 638-645, 2013.

- [10] I. Mateo-Babiano, and H. Ieda, *Street Space Sustainability in Asia: The Role of the Asian Pedestrian and Street Culture*. Journal of The Eastern Asia Society For Transportation Studies, Vol. 7, pp. 1915-1930, 2005.
- [11] B. Cengiz and F. K. Tay, “*The Analysis of Urban Scape for Traditional Street in Safranbolu*”, Journal of Environmental Protection and Ecology, 2016. (in press)
- [12] K. Bates, Making Pedestrian Malls Work Key Elements of Successful Pedestrian Malls in the US and Europe, 2013.
- [13] N. J. Adams, The Pedestrianisation of Inner City Toowoomba, [Usq Project] (Unpublished), 2008.
- [14] H. M. Rubenstein, Pedestrian Malls, Streetscapes, and Urban Spaces, New York, Wiley: 1992.
- [15] Ç. Gülersoy, *The Çırağan Palaces*, İstanbul: İstanbul Kitaplığı Yayınları, 1992, p. 205.
- [16] N. Iranmanesh, “Pedestrianisation A Great Necessity in Urban Designing To Create A Sustainable City in Developing Countries” 44<sup>th</sup> Isocarp Congress, 2008.
- [17] B. Cengiz ve C. Cengiz, “Amasra Tarihi Kent Dokusu ve Yakın Çevresinin Kültürel Peyzaj Açısından Değerlendirilmesi”. I. Ulusal Ankara Üniversitesi Peyzaj Mimarlığı Kongresi, Yerel Peyzajlar ve Koruma Sorunları. 15-17 Ekim 2015, s. 143-154, Ankara, 2015.
- [18] C. Cengiz and P. Keçecioglu, “Evaluation of Urban Identification Elements in terms of Urban Design and Urban Image: Sample of Amasra, Turkey”. 2<sup>nd</sup> International Symposium on Environment & Morality. ISEM 2014. 24-26 October, 2014. Vol I, pp 544-554, Adiyaman, Turkey, 2014.

# Advances in Refractance Window Drying of Foodstuffs

*Inci Cinar*

---

## *Abstract*

*Refractance window (RW) drying is a novel drying technique and is based on spreading food onto a moving transparent plastic film under which hot water circulates and transfers thermal energy to food. Thermal energy required to moisture removal is transferred mostly by radiation rather than convection and conduction since plastic film allows infrared radiation due to refraction. RW drying provides moderate temperature and time frame during drying thus results in higher quality food products as compared to hot air drying and suitable to liquid, pureed and thin sliced foods.*

*The aim of the study is to summarize recent publications on RW drying of foods including fundamentals, heat and mass transfer modelling bases, energy efficiency, potential use in industry and quality retention studies.*

**Keywords:** *RF drying, modelling, energy efficiency, radiation, convection, conduction.*

---

## 1. INTRODUCTION

Drying is one of the oldest preservation methods of foods involving the challenge of water removal from the complex food matrix by the use of different process parameters which result in a reasonable product quality and operating costs. Drying has been and will be playing a significant role in industrial food processing. Therefore new and improved drying techniques considering both properties of raw material and fundamentals of heat and mass transfer to reach the level of efficient and safe processing which in return provide high quality product are needed. Drying, regardless of a type of dryer, targets shelf-life enhancement, cost reduction, nutrient and flavor preservation. Selection of a drying method and equipment have a crucial impact on drying performance and final product quality.

Interest of food industry to RW drying comes from wide range of raw material (fruit, vegetable, meat, eggs, cereals, grains, beverages, spices etc), high quality dried products and low equipment costs. Properties of RW drying are relatively low product temperatures (approx. 70°C), low drying times (3-5min), modular design of dryer, reduction of microbial load up to 4 to 6 decades and ability to handle most liquids without non sugar carriers [1, 2].

Refractance window (RW) drying introduced by MCD Technologies is a short time low temperature film drying technology and RW is a trademark that specifies refractance window drying. Basic construction of RW drying system is given in Figure 1. RW drying is based on carrying thermal energy provided by circulating hot water at 95-97°C to materials to be dried that is evenly thin spreaded on the transparent plastic conveyor belt (e.g. mylar) that floats on hot water and moves at the preset speed. Cool water is circulated on the exit portion of the belt to facilitate the removal of dried product from the belt. Thermal energy is mainly transferred by conduction and radiation from hot water to the drying material whereas convection is between drying material and surrounding air. Drying progresses to a level where material dries and moisture no longer contacts to a plastic belt conveyor leaving conduction as a main mode of heat transfer while infrared radiation reflects back into water. This results in lower drying material temperature (70-80°C) due to poor heat conducting capability of plastic belt conveyor and therefore protect drying material from color, vitamins and antioxidant degradation [1, 3]. Figure 2 shows the industrial application of RW drying.



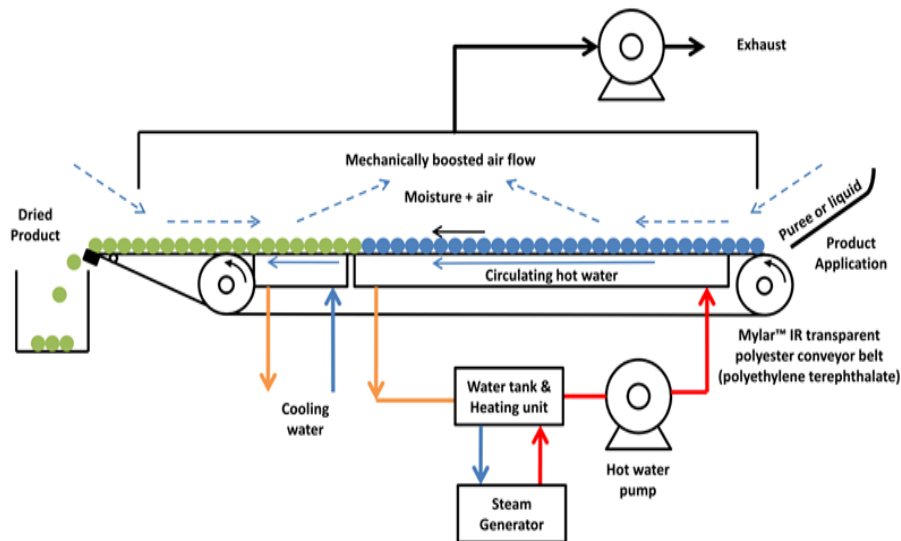

Figure 1. Basic construction of RW drying system [4].

The mechanism of radiative energy transmission into food is mainly provided by closer refractive index between heating water and food product to be dried and ‘refractive window’ is a term referring passage of thermal radiation through plastic film layer when food material has high amount of water. During drying water content of food decreases leading mismatch of refractive indexes between food and heating water which results in reflection of radiative energy back to heating water at the water-plastic film interface. Type and thickness of plastic film and also thickness and moisture content of food material determine the amount of radiated and conducted energies [6].

Previous studies on RW drying have mainly concentrated on the effects of processing conditions on quality properties such as carotenoids, anthocyanins, ascorbic acid, antioxidant activity, microbial inactivation, flavor, aroma and color, physical aspects such as moisture sorption properties, shrinkage, rehydration ratio and energy efficiency and comparison of different drying systems in terms of quality properties [6].



Figure 2. Industrial application of RW drying [5].

Comparing very limited number of publications on heat and mass transfer mechanisms during RW drying, most studies in literature focuses on physicochemical properties of products [7].

Comparison of different drying systems aims to find the drying system with areasonable operational costs and high product quality. Topuz et.al. [8] dried paprika by the use of both freeze and RW drying and reported that browning index of samples had no significant difference between two drying systems but color characteristics were better in RW drying. Topuz et.al. [9] investigated the effect of drying methods (freeze, oven and natural convective drying) on carotenoids, retinol activity equivalent and Scoville heat unit of paprika samples and found that carotenoid content significantly ( $P < 0.05$ ) decreased regardless of drying method while natural convective drying resulted in higher carotenoid and capsaicinoid content due to ongoing synthesis. Caparino et.al. [10] determined physical properties and microstructures of RW, freeze and spray dried mango powder and found that these properties significantly affected by the drying method applied. RW dried and reconstituted mango color was comparable to freeze dried mangos while darker than drum dried and lighter than spray dried mangos. Bulk densities of RW dried samples were higher than freeze and spray dried mangos regardless of particle size and shapes while

glass transition temperatures were not significantly different. Microstructure of RW dried mangos was flaky, smooth and had uniform thickness. According to the findings RW drying yields higher quality mango powders than drum and spray drying and is comparable to freeze drying.

Physical properties and microstructures of drum, spray, freeze and refractance window dried mango powder were studied by Caparino et.al. [11]. RW drying was found to produce mango powder superior than spray and drum drying and comparable to freeze drying. Durigon et.al.[12] used RW drying for powdered tomato production and compared physicochemical properties of RW, spray and freeze dried tomato powders. Maltodextrin addition both increased glass transition temperature which in turn resulted in high solubility rates during rehydration and higher storage stability and eased dried product removal from film layer. Additionally, carotenoid content was higher in RW drying when compared to spray drying.

Baeghbali et.al. [3] compared freeze, spray and RW drying systems on pomegranate juice concentrate as far as quality retention and energy efficiency. Results indicated that the RW drying produced higher anthocyanin content, color and antioxidant activity while energy consumption 1/3 of spray and 1/40 of freeze drying systems. Therefore RW drying was considered as energy efficient drying technique with good quality retention.

Effects of water temperature (75, 85 and 95°C), product thickness (2, 3 and 5mm) and radiant source (transparent and black painted Mylar film) on drying rate were studied for mango pulp during RW drying. Efficient drying determined by evaporation rates of up to 10kg/m<sup>2</sup>h was observed at 2mm thickness and 95°C heating water temperature even if importance of radiant heat transfer was neglected [7].

During RW drying cool air flowing around thin layered food product to be dried contributes evaporative cooling and heated surface is at lower temperature (70-80°C) as compared to 120-150°C at the drum drier. Therefore color, vitamin and antioxidant retention of RW dried products are better than freeze or drum dried products [13].

Effect of processing conditions on quality parameters was also investigated in the literature. Ochoa-Martinez et.al. [14] determined drying kinetics, water activity and color changes during RW drying of mango slices and found that final moisture content of 5% is reached 4 and 8 fold for 2 and 1mm thicknesses respectively as compared to tray drying at 62°C. Effective diffusivities of RW dried samples were higher than air dried ones. Pavan et.al. [15] compared water sorption behavior and thermal data (glass transition temperature) of açai juice during RW, freeze and hot air drying and storage. RW drying resulted in higher moisture content and water activity followed by freeze and hot air drying and GAB and BET models produced good fit to an experimental data. Knowing the fact that glassy state provides higher stability to products during storage, glass transition temperature of oil free solids was found to be between 50 to 60°C. Celli et.al. [13] studied anthocyanin retention, particle size distribution, solubility and microstructure of RW dried haskapberry. Retention of anthocyanins were 90% whereas water solubility was 76% indicating the potential for value added product development studies.

Simultaneous heat and mass transfer modelling of pumpkin slices and particular effects of optical properties of mylar on radiative heat transfer was investigated by Ortiz-Jerez et.al. [6]. Study showed that 99% of thermal energy was transferred by conduction and 5% increase in radiant energy was observed between wet and dry product.

Durigon et.al. [12] used RW drying for powdered tomato production and compared physicochemical properties of RW, spray and freeze dried tomato powders. Maltodextrin addition both increased glass transition temperature which in turn resulted in high solubility rates during rehydration and higher storage stability and eased dried product removal from film layer. Additionally, carotenoid content was higher in RW drying when compared to spray drying.

RW techniques is also used for concentration of juices in the literature. Since evaporation requires high amounts of energy it is important to search alternative techniques. Nindo et.al. [16] used both conventional falling film multi effect and atmospheric RW techniques for evaporation of blueberry and cranberry juices. RW evaporation caused 32 and 48% loss of vitamin C which indicates nutritional quality in blueberry juice at 55.5 and 59°C respectively whereas loss in falling film evaporator at 68°C was 70.1%. Color defined by hue angle was not significantly different in both evaporators for cranberry juice.

## CONCLUSION

Drying, as one of the most traditional methods of preservation, has been a subject to vast number of studies. Rapid changing consumer demands to healthier and less processed food products having qualities closer to the fresh material have been pushing food industry to seek new or improved techniques for food processing. Industrial food processing expected to both limit energy consumption and control waste management for economical and environmental impacts.

## REFERENCES

- [1] Chua K.J. and Chou S.K. (2014). Recent advances in hybrid drying Technologies. *Emerging Technologies for Food Processing*, 447-459.
- [2] Karam M.C., Petit J., Zimmer D. and Djantou E.B. (2016). Effects of drying and grinding in production of fruit and vegetable powders: A review. *Journal of Food Engineering*, 188:32-49.
- [3] Baeghbali V., Niakousari M. and Farahnaky A. (2016). Refractance window drying of pomegranate juice: Quality retention and energy efficiency. *LWT-Food Science and Technology*, 66:34-40.
- [4] Anonymous A. Cleantech and sustainability in the agro-food industry. <http://fca.be/en/article/cleantech-and-sustainability-agro-food-industry>. Date accessed: 10.10.2016.
- [5] Anonymous B. <http://sednanutra.com/products/about-sedna-products/>. Date accessed: 10.10.2016.
- [6] Ortiz-Jerez M.J., Gulati T. and Datta A.K. (2015). Quantitative understanding of refractance window drying. *Food and Bioproducts Processing*, 95:237-253.
- [7] Zotarelli M.F., Carciofi B.A.M. and Laurindo J.B. (2015). Effects of process variables on the drying rate of mango pulp by refractance window. *Food Research International*, 69:410-417.

- [8] Topuz A., Feng H. and Kushad M. (2009). The effect of drying method and storage on color characteristics of paprika. *LWT- Food Science and Technology*, 42:1667-1673.
- [9] Topuz A., Dincer C., Özdemir K.S., Feng H. and Kushad M. (2011). Influence of different drying methods on carotenoids and capsaicinoids of paprika (Cv., Jalapeno). *Food Chemistry*, 129:860-865.
- [10] Caparino O.A., Tang J., Nindo C.I., Sablani S.S., Powers J.R. and Fellman J.K. (2012). Effect of drying methods on the physical properties and microstructures of mango (Philippine Carabo var.) powder. *Journal of Food Engineering*, 111:135-148.
- [11] Caparino O.A., Sablani S.S., Tang J., Syamaladevi R.M. and Nindo C.I. (2013). Water sorption, glass transition and microstructures of refractance window and freeze dried mango (Philippine carabao var.) powder. *Drying Technology*, 1969-1978.
- [12] Durigon A., Souza P.G., Carciofi B.A.M. and Laurindo J.B. (2016). Cast-type drying of tomato juice for the production of powdered tomato. *Food and Bioproducts Processing*, Accepted Manuscript, <http://dx.doi.org/10.2016/j.fbp.2016.06.019>.
- [13] Celli G.B., Khattab R., Ghanem A. and Brooks M.S. (2016). Refractance window drying of haskap berry- Preliminary results on anthocyanin retention and physicochemical properties. *Food Chemistry*, 194:218-221.
- [14] Ochoa-Martinez C.I., Quintero P.T., Ayala A.A. and Ortiz M.J. (2012). Drying characteristics of mango slices using the refractance window technique. *Journal of Food Engineering*, 109:69-75.
- [15] Pavan M.A., Schmidt S.J. and Feng H. (2012). Water sorption behavior and thermal analysis of freeze-dried, refractance window-dried and hot-air dried açai (*Euterpe oleracea* Martius) juice. *LWT-Food Science and Technology*, 48:75-81.
- [16] Nindo C.I., Powers J.R. and Tang J. (2007). Influence of refractance window evaporation on quality of juices from small fruits. *LWT-Food Science and Technology*, 40:1000-1007.

# The Use Of Membrane Processes To Promote Sustainable Environmental Protection Practices

Abdullah Kizilet<sup>1</sup>, Mehmet Akif Veral<sup>2</sup>, Amar Cemanović<sup>3</sup>, Onur Isik<sup>3</sup>, Majid Bahramian<sup>2</sup>, Ozer Cinar<sup>\*2</sup>

---

## Abstract

The aim of this study is to promote membrane employment for sustainable environmental protection practices in terms of retaining the depletion of natural resources at a grade less than their proportion of renewal and consumption and employment of as much renewable resources as possible instead of depletion of unrenovable resources. Furthermore, information on life cycle assessment of products and manufacturing systems is provided. Energy and water are the indispensable resources for the mankind wealth. The increased energy needs arising from developing technologies, increasing population and limited resources have led people to turn to sustainable methods, especially in the case of limited water resources. There has been growing rate of interest for biological wastewater treatment methods by membrane employment. Separation of solid-liquid mixtures is implemented in the way of biological wastewater treatment; especially MBRs have critical role for treatment processes. MBR operations allow biological treatment and disinfection without utilization of chemicals and the amount of produced sludge is less due to unemployment of SRT. Although membrane technology still needs to be improved regarding energy consumption, membrane and/or module manufacturing costs, durability and expertise, it has an important place in the energy-efficient sustainable water supply, industrial wastewater management processes and energy production. In addition to this, they are flexible and adaptable for module modification and latest novelties. In literature, limited researches have been practiced so far dealt with the issue of public acceptance of certain methods being applied. Future research may focus on overcoming the issue of membrane fouling, by devising methods for efficient cleaning, preferentially without employment of dangerous chemicals, as well as by investigating new types of membranes.

**Keywords:** Biological treatment, MBR processes, Renewable and sustainable environmental protection

---

## 1. INTRODUCTION

### Increased use of water and energy

Energy a word with simple meaning in linguistic but an issue for scientists. Societies grow in number as technology solves the equation for longer life, however planet has specific amount of energy. This is much true and also complicated in water sector as we realize that it possesses both life and energy. It is an awe-inspiring idea to develop a system to explore the energy stored in water and wastewater. There has long been a controversy surrounding what would be an ideal system to purify used water, as known it wastewater, and also reuse the impurity separated from. In 1969, Budd et al. [1] used ultra-filtrated membranes as a solution for high removal efficiency and also to separate sedimentation tank from activated sludge in water treatment plants. They reached an effluent with BOD under 5 mg/l and nearly no sign of coliform bacteria. This processes had some advantages such as low sludge production, high quality water production and low maintenance. However, high operation costs prevented its wide spread application. A group of Japanese researchers [2] installed Hollow-Fiber (HF) membranes inside an activated sludge reactor and operated a suction pump directly over the membrane to catch the permeated water. Treated water was produced at low suction pressure (13 kPa), short hydraulic retention times (4 h), high loading rate (1.5 kg COD/m<sup>3</sup>-days), and relatively long operating periods (120 days). This study was the beginning of wide-spread usage of MBR for treatment of both municipal and industrial wastewaters as it possessed the possibility to produce much cleaner water with low energy demands.

### Life cycle assessment of products and manufacturing systems

Sustainability is principally defined as the appropriate integration of environmental fineness, economic affluence and socialeven-handedness [3,4]. In fact, it refers to the equilibrium between environment, industry and economic. Various tools have been developed to assess the behavior of industries and their associated manufacturing processes, among which Life Cycle Assessment (LCA) is the most popular and at the same time most reliable method. It is a structured and analytical procedure that provides detailed assessment for environmental sustainability. Unfortunately, LCA has been applied to MBR systems only in a few cases for treating urban wastewater [5, 6, 7]. It should be mentioned that the comparison of the results of different LCA studies, cannot be direct, since each study has a different goal and scope definition, different impact assessment

---

<sup>1</sup>Department of Bioengineering and Sciences, Kahramanmaraş Sutcu Imam University, 46100, Kahramanmaraş, Turkey  
[abd.kizilet@gmail.com](mailto:abd.kizilet@gmail.com)

<sup>2\*</sup>Yildiz Technical University, Department of Environmental Engineering, 34220, Esenler/Istanbul, Turkey  
[ocinar@yildiz.edu.tr](mailto:ocinar@yildiz.edu.tr)

<sup>3</sup>Istanbul Technical University, Department of Environmental Engineering, Maslak/Istanbul, Turkey

methods are used, the assumptions made are not totally equivalent, while also the energy mix and the geographical location of each study are different [5]. In the study, the environmental impacts of an MBR used for the treatment of domestic wastewater were compared with those of three other treatment technologies (reedbeds, membrane chemical reactor and green roof recycling system) [8]. In addition, according to Ortiz et. al. [6] both external and submerged MBR systems have lower environmental impacts than a CAS system followed by tertiary treatment, for the treatment of domestic wastewater. Hospido et al. [9] studied the footprints of four different MBR configurations. Their study indicated that electricity consumption and agricultural application of sewage sludge are playing the most important role as the environmental impacts were identical for all four MBR configurations.

## Renewable energy sources and sustainable environmental protection

It is critical to remind that energy is a fundamental source for us in terms of development. It has been thought that present resources were found as abundant for a long time. Augmentation of the population in the world and also technological progresses swapped-in throughout the industrial revolution, demand to the energy swelled and it was hinged upon the inadequacy [10]. However, utilization and increment of the energy in the world ensured from petroleum, petroleum derivatives, coal, natural gas and electricity produced from the nuclear power plants (NPP). Since all the energy resources from underground are not being virginally comprised, they are once for all limited. It is estimated that energy demand will enduringly increase in following years which will be resulted as a prevailing need for the fertile use of it. Such resources which can be used under the name of renewability are differentiated as biologic entries for sustainability and acceleration of their expansion in a positive axis is worth of note. To provide sustainability, renewable energy sources can be listed as power from wind, water, biomass, solar light and photovoltaic energy, wave, tide, earth that provides geothermal energy and etc. [11]. Renewable energy sources have tremendous potential as a clean and environment friendly energy source and throughout its energy production, no irrecoverable pollution can occur [12]. Thus, they pave the way for sustainability of the environmental protection. In this context, membrane technologies, especially membrane bioreactor (MBR) systems, have great importance in water and energy sustainability. Although MBR operations have some handicaps, such as cost, energy consumption, maintenance etc., it has significant importance for productive land utilization, simple operation and applicability [13].

## 2. MEMBRANE TYPES AND PROCESSES

MBR systems generally integrate the employment of bio-processes and membrane engineering to refine wastewater. In late nineteenth century, employment of the treatment method, regarding upon biological way, can be observed but being a model procedure for the treatment of the wastewater begins from the 1930s [14]. Industrial and municipal wastewater samples are exposed to treatment processes in terms of having better permeate quality by employment of aerobic and/or anaerobic treatment processes [15]. When the soluble matter that can be degraded in biological way eliminated from the environment, generation of the biomass requires an entanglement from the liquid flow to ensure necessary permeate quality. Exposing permeate to the gravitational force in secondary tank, operation called traditional process, paves the way for the final separation of the solid/liquid mixture that is frequently a barrier for the permeate quality [16]. There are different types of materials in use for the selection of the membranes. Due to the congruity, only a few membrane types are widely used and it is known that there are several limitations that diminish the number of materials in use. Membranes should have high acidic, basic, chemical and mechanical endurance properties and they should be performed in the pH range between 4-10. However, 1-12 pH is also employed during the membrane reuse and cleaning. There are still unknown toxic chemicals, oxidants, and membrane materials which may be subjected to these chemicals by providing high shear force from water and air, throughout the process. Some of the polymers used as a membrane material are listed as following; polysulfone (PSF), polyethersulfone (PES), polyolefins: polyethylene (PE), polypropylene (PP) and polyvinylchloride (PVC), polyvinylidene difluoride (PVDF), polytetrafluoroethylene (PTFE) and cellulose acetate (CA) [17, 18, 19]. Membrane processes diverse in each other according to density and porous structure. Pressure driven membrane operations are reverse osmosis (RO), nanofiltration (NF), ultrafiltration (UF) and microfiltration (MF). However there are extractive and/or diffusive membrane operations such as; electro dialysis (ED), pervaporation (PV), membrane extraction (ME) and gas transfer (GT).

### A brief definition for every type of membrane processes

There are different types of membrane processes employed according to their type and pore size diameter which is directly dependent to the semi-permeability of a membrane in MBR systems. Biggest pore size and, thereby, lowest permeability property belongs to the microfiltration (MF, >50 nm) (IUPAC, 1985) and it provides a separation process for suspended solids (SS) by sifting through over the membrane pores. Controversially, RO has the highest semi-permeability characteristics and even single charged ions, like alkali metals/halogens, can be retained [20]. Nonetheless, it ensures that dividing the dissolvability and diffusion rate of solvent and solute inside of the water. Therefore, RO and NF (<2 nm) are used for the solute elimination. While NF is called as 'leaky' RO, disentanglement succeeded throughout the combination of charge denial. In addition to this, MF and UF (2-50 nm), which are mostly used due to biological justifications, is employed for the small colloidal particles removal [21]. One of the fundamental extractive or diffusive membrane process is electro dialysis (ED) which is actually used for the separation quality of ionic size, charge and solute ions' density in terms of charge. On the other hand, since pervaporation (PV) represents the same principal with RO, it actually deals with the partial vacuuming of volatile constituents, which are tent to evaporate partially, on the surface of the membrane. Membrane extraction (ME) method interests the concentration of the matter which cannot be filtrated and effluent part of the membrane. Nevertheless, in gas transfer (GT) process, gas is transported under at significant rate of pressure into/out of liquid in molecular manner [17].

### Membrane processes main applications

MBR system modifications have been applied in various industrial processes wastewater such as food industry, petrochemical industry, dying wastewater, hospital wastewater, and textile industry. The reasons for the wide usage of MBR processes in industries are the resistance of toxic substances, high heavy metal removal capacity and treatment ability of refractory substances [22, 23, 24]. In drinking water treatment operations, coagulation, flocculation, sedimentation, filtration and disinfections processes can be integrated into a single process with MBR systems [24]. Besides wastewater treatment, one of the main applications of membrane processes is biofuel (bioenergy) production in the form of bioethanol, biogas (methane and hydrogen), and biodiesel. Biofuels are designated as first, second or third generation based on the raw material they are produced from. First generation biofuels are derived from sugar, starch and vegetable oil [25]. Second generation biofuels are produced from the stalks of wood, wheat, corn, and some non-food based feedstocks [26]. Algae are the raw material for the third generation [27]. The process of biomass conversion to biofuel requires appropriate separation technologies. Some of the membrane processes that are applied in the process of bioenergy production are: microfiltration (MF), ultrafiltration (UF), nanofiltration (NF), pervaporation (PV), membrane distillation (MD), etc. [28]. Due to the properties of ethanol, the most suitable processes for its obtainment are PV and MD. In the case of biogas and biodiesel, those are MF and UF, and for the latter product also NF. The most common configurations applied are flat sheet, tubular, hollow fiber, plate-and-frame, capillary and spiral wound [28].

### 3.SUSTAINABLE ENVIRONMENTAL PROTECTION AND MEMBRANE PROCESSES

Membrane processes receive a growing amount of interest due to their advantages over conventional systems. MBR systems have an extensive usage field from water treatment to water reuse, because of high quality effluent, high biomass capacity, low space requirement, low sludge production, high chemical durability of some membrane types and high disinfection capacity [29]. MBR systems have increasing importance in municipal water treatment and water supply all around the world. MBR systems are defined as the “best available technology” for many industries, because of the reuse potential of MBR effluents [30]. MBR systems are used for municipal and domestic wastewater treatment systems, because of high removal capacity of organic matter, suspended solids, phosphorus and nitrogen [24]. Furthermore, they contribute to a sustainable environmental protection through their role in biofuel production, a renewable energy source.

#### Advantages and disadvantages of CAS, MBR and D-MBR associated with sustainable environmental protection

Scientists and researchers are directed to alternative energy sources due to previous uncontrolled usage of fossil fuels and current rapid growth of the world population, advancing technology and energy storage ideas for the future. In this context, MBR and D-MBR systems have attracted to increasing interest and it become more of the issue for both academic and commercial environment in wastewater treatment with respect to energy saving over the conventional activated sludge system (CAS systems). Sustainable environmental protection is the most important issue connected with energy saving. Especially, MBR and D-MBR systems play a significant role for both wastewater and drinking water applications to provide sustainable environmental protection. The membrane bioreactor (MBR) employed for microfiltration (MF) / ultrafiltration (UF) support materials are used to provide solid and liquid separation in the bioreactor, and the reaction eventually does not require secondary clarifier. In this context, when comparison is made among CAS, MBR and D-MBR, use of membrane filtration for solid-liquid separation ensures higher effluent quality for wastewater reclamation and reuse. MBR and D-MBR have many advantages such as, higher biomass concentration, smaller footprint, lower sludge production and rejection of SS (effluent from SS is close to zero) [31]. Especially, MBR and D-MBR systems' features, such as less treatment time, less manpower and less energy consumption, can be evaluated in the sustainable environmental protection when compared to the CAS. Also, D-MBR and MBR systems can be affected by the amount of biomass, the metabolic activities of the microorganisms and the microbial products of the biomass. In a struggle to understand the latter, a range of molecular microbial ecology methods have been developed [32] corresponding with sustainable environmental. MBR and D-MBR systems have been widely applied in full scale and laboratory scale wastewater treatment process thanks to supply higher MLSS concentration, better control of SRT, higher volumetric loading, production of high-quality effluent when compare with CAS [33]. However, the application of MBR is restricted by its high membrane module cost and membrane fouling [34]. So, many researchers attempted to use cheap covered material for replacing the expensive micro-/ultra-filtration membrane for decrease the high cost [35]. Despite it is claimed advantages of better treatment method performance and occupation of much less land, broader application of MBRs is still hindered by their relatively high construction cost and energy consumption [36]. For these reasons, in recent years done extensive research on D-MBR instead of MF and UF membrane is trying to eliminate the cost of the MBRs. Dynamic membrane is formed on the underlying a support materials when filtering the wastewater from the reactor, so is also called secondary membrane [37]. Mesh, woven and nonwoven fabrics are used instead of MF or UF [38] in the D-MBR, by this means operating costs of D-MBR are much lower than the CAS and MBR systems, also environmentally friendly practices from the point of view sustainable environmental protection. Based on the findings of several studies in the literature about the considering the relative advantages and disadvantages of MBR, D-MBR and CAS systems general information, Sustainable environmental protection taking into account, are tabulated in the Table 1.

Table 1: The comparison of comparatively advantages and disadvantages of MBR, D-MBR and CAS

MBR		D-MBR		CAS	
Advantages	Disadvantages	Advantages	Disadvantages	Advantages	Disadvantages
High MLSS	-----	High MLSS	-----	-----	Lower MLSS
Low footprint	-----	Low footprint	-----	-----	Large footprint
Higher volumetric loading	-----	Higher volumetric loading	-----	-----	Lower volumetric loading
Fine control of SRT	-----	Fine control of SRT	-----	-----	Workload for SRT control
-----	Greater operational and process complexity	-----	Greater operational and process complexity	Easier operational and process complexity	-----
Lower sludge production	-----	Lower sludge production	-----	-----	Higher sludge production
-----	Higher capital Low operational costs	Low capital Low operational costs	-----	-----	Higher capital High operational costs
-----	Greater foaming propensity	-----	Greater foaming propensity	Lower foaming propensity	-----
Treated water that reusable	-----	Treated water that reusable	-----	-----	-----
Unlimited by settling due to gravity	-----	Unlimited by settling due to gravity	-----	-----	It is limited by settling due to gravity
-----	High Module Cost	Low module cost	-----	-----	-----
Sample TMP control based on constant flow	-----	-----	-----	Complex TMP control based on constant flow	-----
Sample fouling control	-----	-----	-----	Complex fouling control	-----
Chemical wash easier applied	-----	-----	-----	Chemical wash not easily applied by taking into account microorganisms	-----
Very high physical disinfection performance	-----	Normal physical disinfection performance	-----	-----	-----
Affected undirectly by Bulking problem	-----	Affected undirectly by Bulking problem	-----	-----	Affected directly by Bulking problem

Chemical treatment is not preferred because it is a secondary cause pollution. At this point, D-MBR systems have importance for used only microorganisms for wastewater treatment. But, D-MBR systems have also some disadvantage as fouling. The main fouling reason was reported in the previous studies due to increased bacterial growth [39]. So, they do not frequently needed to chemical and physical cleaning [40]. Despite physical operations such as, water backwashing, air back washing, brushing, intermittent suction (relaxation) and cross flow are enough for MBR and D-MBR systems, sometimes these operations temporarily cause to effluent quality (high MLSS). In the light of all these findings, although D-MBRs are more advantageous compared to MBR and CAS, some disadvantages associated with the cake layer develop on the membrane surface. So, a well-defined and systematic comparison of D-MBR, MBR and CAS about wastewater treatment, must be of fundamental importance, thoroughly and meticulously [41]. The main advantage of MBR and D-MBR systems is sludge retention time (SRT) can be controlled easily as completely independent from hydraulic retention time (HRT). So, a very long SRT can be operated resulting in the complete retention of slow-growing microorganisms such as nitrifying or methanogenic bacteria and this results in greater flexibility of operation sustainable environmental protection taking into account [42].

### Involvement of MBR systems in the sustainable environmental practices

Sustainable environmental practices is getting importance with each passing day. Development of green built environments is one of the most important sustainable environmental act. The main purpose of green buildings act is eliminated negative impact of buildings on their environments, and create eco-friendly, energy-efficient buildings for future green eco-cities [43]. In this

connection, water management and wastewater treatment have vital importance for future [28]. Hybrid membrane techniques like MBR methods and their sub-categories have an important role in green design for urban and municipal applications, because of membrane systems advantages such as cost-effectiveness, user-friendliness and eco-friendliness [43].

## 4. CONCLUSION

Membrane-based methods play an increasingly important role in sustainable processes such as renewable energy production and wastewater treatment. Their main advantages are high processing efficiency, lower energy consumption over conventional systems, high chemical durability as well as wide applicability. Membrane systems are available in various configurations and are based on different principles, and as such are not without drawbacks - the main being membrane fouling. Further R&D will surely build upon the current findings and provide even more advanced solutions for sustainable environmental protection and biofuel production.

## 5. PERSPECTIVES FOR THE FUTURE

Since membrane fouling is the main challenge associated with the use of membrane-based systems, future research has to be focused on controlling this phenomenon. This can be achieved by careful optimization of operating conditions, such as backwashing/scouring aeration, SRT, HRT and TMP (transmembrane pressure). This is significant not only for the increase in the membrane life and the decrease in washing frequency, but also for efficient energy consumption. Furthermore, different materials should be investigated so as to find more efficient and/or cheaper alternatives to the currently used ones. Additionally, integration of different membrane methods into one system may contribute to the maximization of efficiency and minimization of the flaws the methods display when applied solely. Besides the technical aspects, room for improvement is also present on the biological side. Research into new species/strains of microorganisms should lead to the discovery of more efficient and adaptable types. Alternatively, known species may be genetically engineered to improve their properties. The properties to be targeted hereby would be: process efficiency, adaptability to various conditions, adaptation time, requirements for optimal growth etc.

## ACKNOWLEDGEMENTS

Author Amar Ćemanović is supported by the Scientific and Technological Research Council of Turkey (Tübitak) through the 2215 Graduate Scholarship Program

## REFERENCES

- [1] W. E. Budd, R. W. Okey, Dorr-Oliver Inc. Membrane separation in biological-reactor systems, google patent, US 3472765 A, 1969.
- [2] C. Chiemchaisri, Y. K. Wong, T. Uruse, K. Yamamoto, Organic Stabilization and Nitrogen Removal in Membrane Separation Bioreactor for Domestic Wastewater Treatment. *Water science and technology*. 25 (10) 231-240, 1992.
- [3] P. Kumar, B. Imam, Footprints of air pollution and changing environment on the sustainability of built infrastructure. *Science of Total Environment*; 444:85–101. 2013
- [4] C. Du Plessis, P. Randon, An ecological world view as basis for a regenerative sustainability paradigm for the built environment. *J Clean Prod*, 2014.
- [5] N. Tangsubkul, S. J. Beavis, S. Moore, T. Lundie, D. Waite. Life Cycle Assessment of Water Recycling Technology, *Water Resource Management* 19: 521. doi:10.1007/s11269-005-5602-0. 2005
- [6] M. A. Ortiz-Rubio, E. R. Orskov, E. R. J. Milne, H. M. A. Galina, Effect of different sources of nitrogen on in situ degradability and feed intake of Zebu cattle fed sugarcane tops (*Saccharum officinarum*). *Animal Feed Science and Technology*, 139 (3-4): 143–158. 2007
- [7] J.C. Pasqualino, M. Meneses, M. Abella, F. Castells. LCA as a decision support tool for the environmental improvement of the operation of a municipal wastewater treatment plant. *Environmental Science and Technology*, 43 (9), pp. 3300–3307. 2009
- [8] F. A. Memon, Z. D. Butler, S. Smith, L. Makropoulos, Life Cycle Impact Assessment of Greywater Recycling Technologies for New Developments. *Environmental Monitoring and Assessment*. Volume 129, Issue 1, pp 27–35. 2007.
- [9] A. Hospidod, L. Corominas, L. Foley, J.S. Guest, H. F. Larsene, S. Morera, A. Shawg. Life cycle assessment applied to wastewater treatment: State of the art, *Water Research*, 47, 15, 5480–5492. 2013
- [10] T. B. Johansson, H. Kelly, A.K.N. Reddy and R. H. Williams "Renewable energy: sources for fuels and electricity, Earthscan. Island press, 1993.
- [11] John Twidell and Tony Weir. *Renewable energy resources*. Routledge, 2015.
- [12] Antonia V. Herzog, Timothy E. Lipman, Daniel M. Kammen. "Renewable energy sources." *Encyclopedia of Life Support Systems (EOLSS)*. Forerunner Volume- Perspectives and Overview of Life Support Systems and Sustainable Development, 2001.
- [13] Ngoc Lieu Le and Suzana P. Nunes. "Materials and membrane technologies for water and energy sustainability." *Sustainable Materials and Technologies* 7: 1-28, 2016.
- [14] B.E. Rittmann, Aerobic biological treatment. *Environmental Science and Technology* 21: 128–136, 1987.
- [15] C. Visvanathan, R. Ben Aim, K. Parameshwaran, 'Membrane separation bioreactors for wastewater treatment'. *Critical Reviews in Environmental Science and Technology* 30: 1–48, 2000.
- [16] LD Benefield and CW Randall, *Biological Process Design for Wastewater Treatment*. Englewood Cliffs, NJ: Prentice Hall, 1980.
- [17] Simon Judd, *The MBR book: principles and applications of membrane bioreactors for water and wastewater treatment*. Elsevier, 2006.
- [18] Hee-Deung Park, In-Soung Chang, Kwang-Jin Lee. *Principles of Membrane Bioreactors for Wastewater Treatment*. CRC Press, 2015.
- [19] Tom Stephenson, *Membrane bioreactors for wastewater treatment*. IWA publishing, 2000.
- [20] S. Judd, B. Jefferson, *Membranes for industrial wastewater recovery and re-use*, Elsevier, Oxford, 2003.
- [21] G. Pearce, Introduction to membranes: Filtration for water and wastewater treatment. *Filtration and Separation* 44(2): 24–27, 2007.
- [22] He Y., Li G., Wang H., Jiang Z., Zhao J., Su H., Huang Q. Diafiltration and water recovery of reactive brilliant blue KN-R solution by two-stage membrane separation process. *Chem Eng Process*, 2010, vol. 49, pp. 476–483.
- [23] Moslehi, P., Shayegan, J., Bahrayma, S. Iran. J. Performance of Membrane Bioreactor in Removal of Heavy Metals from Industrial Wastewater. *Chem. Eng.* 2008, vol. 5, pp. 33–38 (IACHÉ).



- [24] Wen G., Ma J., Zhang L., Yu G. Membrane Bioreactor in Water Treatment. *Comprehensive Memb Sci and Eng.*, 2010 vol. 4, pp. 195-209.
- [25] Demirbas A. Competitive liquid biofuels from biomass. *Appl Energy* 2011;88:17-28.
- [26] Sims REH, Mabee W, Saddler JN, Taylor M. An overview of second generation biofuel technologies. *Bioresour Technol* 2010;101:1570-80.
- [27] Costa JAV, de Morais MG. The role of biochemical engineering in the production of biofuels from microalgae. *Bioresour Technol* 2011;102:2-9.
- [28] Y. He, D.M. Bagley, K.T. Leung et al., "Recent advances in membrane technologies for biorefining and bioenergy production," *Biotechnology Advances*, vol. 30, pp. 817-858, 2012.
- [29] Judd S. *The MBR Book: Principles and Applications of Membrane Bioreactors in Water and Treatment*. Elsevier, Oxford (2011)
- [30] Lesjean B., Huisjes E.H. Survey of the European market: trends and perspectives, *Desalination* 231 (2008) 71-81
- [31] L. Defrance and M.Y. Jaffrin, "Comparison between filtrations at fixed transmembrane pressure and fixed permeate flux: application to a membrane bioreactor used for wastewater treatment", *J. Membr. Sci.*, 152, 203-210, 1999.
- [32] E. Scholes, V. Verheyen, P. Brook-Carter, "A review of practical tools for rapid monitoring of membrane bioreactors", *Water Research*, 102, 252-262, 2016.
- [33] Seo, G.T., Moon, B.H., Lee, T.S., Lim, T.J. and Kim, I.S. (2002). Non-woven fabric filter separation activated sludge reactor for domestic wastewater reclamation. *Wat. Sci. Tech.*, 47(1), 133-138.
- [34] H. van der Roest, A. van Bentem, P. Schyns, C. Uijterlinde. "Ten years of MBR development: lessons learned from the Netherlands," *Water* 2117-23, 2012.
- [35] Fan, B., Huang, X., 2002. Characteristics of a self-forming dynamic membrane coupled with a bioreactor for municipal wastewater treatment. *Environ. Sci. Technol.* 36, 5245-51.
- [36] J. Sun, K. Xiao, X. Yan, P. Liang, Y. Shen, X. Huang and N. Zhu, "Membrane bioreactor vs. oxidation ditch: full-scale long-term performance related with mixed liquor seasonal characteristics", *Process Biochemistry*, 50, 2224-2233, 2015.
- [37] V.T. Kuberkar, R.H. Davis, Modeling of fouling reduction by secondary membrane, *J. Membr. Sci.* 168 (2000) 243-25
- [38] Lee, J., Ahn, W.Y., Lee, C.H., 2001. Comparison of the filtration characteristics between attached and suspended growth microorganisms in submerged membrane bioreactor. *Water Res.* 35 (10), 435-2445.
- [39] E. Sahinkaya Nesrin Dursun Use of elemental sulfur and thiosulfate as electron sources for water denitrification *Bioprocess Biosyst Eng.* 38, 531-541, 2015
- [40] Chu, H.Q., Cao, D., Jin, W., Dong, B.Z., 2008. Characteristics of bio-diatomite dynamic membrane process for municipal wastewater treatment. *J. Membr. Sci.* 325, 271-276.
- [41] K. Xiao, Y. Xu, S. Liang, T. Lei, J.Y. Sun, X.H. Wen, H.X. Zhang, C.S. Chen and X. Huang, "Engineering application of membrane bioreactor for wastewater Treatment in China: current state and future prospect", *Front. Env. Sci. Eng.* 8, 805-819, 2014.
- [42] C. Visvanathan, R. Ben Aim, and K. Parameshwaran, "Membrane Separation Bioreactors for Wastewater Treatment", *Critical Reviews in Environmental Science and Technology*, 30(1), 1-48, 2000.
- [43] Rashidi H., GhaffarianHoseini A., GhaffarianHoseini A., Sulaiman N.M.N., Tookey J., Hashim N.A. Application of wastewater treatment in sustainable design of green built environments: A review. *Renewable and Sustainable Energy Reviews*, 2015, vol. 49, pp.845-856.

# Sensations in Pediatric Development

Mudriye Yildiz Bicakci <sup>1</sup>, Hulya Tercan <sup>2</sup>

---

## Abstract

Information that children get as a result that they interact with daily-life stimulants from their birth affect positively on brain development. Learning occurs with genetic potential and environmental factors. Events which occur in brain during the process of learning become fact with synaptic connections between brain cells. Synaptic connections which develop as a result of an environment that is full with rich stimulants base for children to gain more complex cognitive skills. It provides opportunity that learning's occur as there is a communication between children and environment from babyhood by supporting brain development and this case occurs by the stimulation of sensations. Babies learn to get each kind of sensations stimulant and to respond them from the moment of their birth. They start to know quickly about world around them with their sensations of taste perception, hearing, olfaction, touch and eyesight. In this process that child has got, it obliges that the sensation training is done as a training which starts from the child's birth as a result that he/she configures information related to world through sensations. Samples of activity related to sensation development in children, to support sensation development with supportive material and environment for sensations were presented in this study with this view.

**Keywords:** Child and sensation, sensation development, sensory integration

---

## 1. INTRODUCTION

Child development is defined as a process that progresses with children's knowledge, skill and behaviors that they get and enrich as they grow up. In another saying, it is defined as an alternation process of skills and abilities in a complex way with suitable experiences that they have in time (Berk, 2013; Meraki and Yildiz Bicakci, 2015). Sensations' development and supporting them have got important place in the process of child's development. Especially, sensations have got important place that child could adapt to environment and sustain his/her life. Sensations are important for factors such as the protection from danger, the ability to sustain life, having healthy social relations, the ability to be successful in work life (Cetin and Aral, 2015). Sensations can be defined as stimulants which are taken from environment through the central nervous system and in this sense, organism or activated. Child's development goes on in parallel with sensations' development. Sensations progress quickly in parallel with general development in babyhood and early childhood years. Babies learn their environment through their sensational experiences and their learning life occurs. Although sense of smell does not develop too much in newborn babies, sense of taste develops relatively (Dunn, & Daniels, 2002; Dunn, 2007; Bee and Boyd, 2009). Baby who is in the oral stage uses his/ her mouth. He/she tried to know the objects in hand as taking them to his/her mouth. He/she looks through objects by touching them instead of taking them into mouth up to the end of babyhood stage. As newborn baby does not gain visual acuity just now, he/she cannot perceive objects fully around them. When it is considered that development progresses from the center to the environment, babies look firstly through their hands and feet and then, baby gets more sufficient environment in sensational aspect as getting visual acuity on the immediate environment and in the progressing periods and as approaching to adults' level. He/she has got much more sensational experiences with the qualitative and quantitative increase in his/her visual acuity and physical development. Physical development and eyesight development bring with the development in balance and awareness of body. When the development is very rapid in childhood stage, it is necessary to support sensational development of this stage's children through sensational materials or activities which are proper to their age, development level and their personal needs. It is necessary to provide rich environmental stimulants for children in this stage (Dunn, & Daniels, 2002; Dunn, 2007; Bee and Boyd, 2009; Jewers, Staley, & Shady, 2013; Santrock, 2014; Cetin Sultanglu & Aral, 2015). Information that children get as a result of having interaction with daily-life stimulants from their birth affect positively on brain development. Synaptic connections which occur as a result of an environment that is full with rich stimulants support general developments with sensational development as being a base for children to get more complex cognitive skills. Children's interaction with their environment provides opportunity for the occurrence of learning's as supporting brain development and this case occurs by the stimulation of sensations. Children learn to get each kind of sensations' stimulant and to respond them from the moment of their birth. They start to know quickly about world around them with their senses of taste, hearing, olfaction, touch and eyesight (Dunn, & Daniels, 2002; Dunn, 2007; Bee & Boyd, 2009; Tastepe & Başbay, 2015). As child configures information related to world through sensations in this stage, the importance of supporting sensations, sensation-supportive material and environment and assessment of sensations were reviewed besides sensation developments in children in this study.

---

<sup>1</sup>Corresponding author: Ankara University, Department of Child Development, 06340, Altındağ/Ankara, Turkey. [mudriyebicakci@gmail.com](mailto:mudriyebicakci@gmail.com)

<sup>2</sup>Hacettepe University, Department of Child Development, Sıhhiye/Ankara, Turkey [hulya.tercan@hacettepe.edu.tr](mailto:hulya.tercan@hacettepe.edu.tr)

## 2. DESCRIPTION AND CATEGORIZATION OF SENSATIONS

Sensation is stated as a neurophysiological energy which occurs by the stimulation of receiving cells under the effect of physical energy in the external environment. This neural energy is processed in brain and percept occurs in the end of the process (Ozata, 2015). Sensation means sense in general definition and also he/she can perceive changes such as physical, chemical, electrical and spiritual stimulants which occur in living creature's environment and themselves, and he/she can form his/her life in accordance with these sensations (Dunn, 2007; Fazlıoğlu, 2004; Cetin Sultanğlu & Aral, 2015).

Sensations take on tasks which are necessary for life with information that they get from internal and external stimulants. While one of these tasks provides to survive, the other supports individuals to be active and social by providing a safety environment. All sensations response properly when they work accordantly together. Brain processes sensation input by getting many stimulants, and as it works more efficiently so behavioral outputs become more efficiently like that. As outputs are more efficient, new sensational information provides much more feedback to persons by helping them. So sensational process which never ends for life goes on (Dunn, 2007; Fazlıoğlu, 2004; Kranowitz, 2014).

Sensations go into division as specific sensations and general-deep sensations.

### 2.1. Specific Sensations

Specific sensations are sensations of eyesight, hearing, taste and olfaction. At the same time, these sensations are named as distant sensations as they take information from environment to brain (Cetin Sultanğlu & Aral, 2015). Specific sensations occur with the mutual interaction of data with eyes, ears, tongue, nose and skin through sensations. For example, the sensation of hearing occurs with the guidance of vibration waves in air to brain cells through aural nerves and bones of internal ear as gathering in external earnings. Sensation of eyesight occurs as rays focus in retina as result of its contact with eye and as being received to visual cortex with optic nerves (Nelson, 2008).

### 2.2. General- Deep sensations

General-Deep sensations; general-deep sensations which are named as somatic sensations are; inner of organism such as balance, situation, deep paid, deep pressure sensations and touch sensations. They are named as close or unseen sensations. These sensations cannot be controlled and they cannot be directly observed. Close sensations are generally named as sensations of touch, balance and awareness of body (Dunn, 2007; Sultanoğlu Cetin and Aral, 2015).

## 3.SENSATION DEVELOPMENT

Structural development of sensations areas start before the birth. For example, fetus can hear in the last two months of pregnancy. Sensations which are tangible data sources in babyhood have got importance to know world and perceive it. The percept which is the association of data in research form which come by two or more sensational is available from the babyhood and it becomes more definite in life's first years. Stimulants (sensory input) which are taken by sense organs reach to the central nervous system and they are made sense by sense-progressing center as they are progressed. The behavior to response properly to stimulant follows it. Perception process occurs by brain's functions in this way. It is different to name all senses in brain. Vestibular sensations are balance, gravity and move, tactile sensations are touch, proprioceptive sensations are sensations from body position, muscle and joints, aural sensations include communication and ways to protect itself. Visual and aural sensations are related to many centers of brain. Moreover, it is stated that vestibular, proprioceptive and tactile sensation areas affect on visual and aural areas. Vestibular, tactile and proprioceptive systems are completed in the womb, and visual and our systems complete their development later. From the first month, tactile sensation (touch), vestibular sensation (balance and move), proprioceptive sensations (joint and muscle), first-level sensation system which is visual and aural sensations develop. From the first age, perceptual -motor bases which include skills such as body image, bilateral coordination, lateralization, motor planning (skill- praxis) develop. Vestibular and proprioceptive sensations are named as inner sensations. Child who starts to walk from the second ages develops himself/herself in each area as having new learning experiences. Perceptual -motor skills which include skills such as aural perception, visual perception, hand-eye coordination, purposive activities develop from the third age. Academic skills such as attention, self knowledge, control, advanced motor skills, organized behavior and visualization develop from the sixth age. Even if the child's development is slow or rapid, this order is the same for all of children (Dunn ve Daniels, 2002; Fazlıoğlu, 2004; Dunn, 2007; Jewers, Staley, & Shady, 2013; Yurteri Tiryaki & Baran, 2015).

## 4. MATERIALS OF SENSATION

Materials accelerate the learning of baby and child as providing that they learn their environment, and they provide persistency in learning. Materials are chosen in consideration with children and babies' development properties, interest, needs and expectations and it makes the process of learning more significant for babies and children with this aspect. The importance of materials' existence and resource which are used as a stimulant factor in child's environment in the developmental process is seen, it is known that it has got importance in each grade of education in the phases; to gain certain skills, to make comprehension of abstract concepts difficult to be understood as materializing them, to reinforce information which are learned. Especially, sensational materials have got great contribution to support children's motor, social, affective, cognitive and language development areas (Akca & Bicakci, 2015).

### 4.1. Material Samples Which Are Supportive for Sensations towards Babies

Game materials which are supportive for sensational development should be provided to babies from the newborn stage. Toys which their touch or sound properties are emphasized are used like rattles, mobile, sensory blankets, pillows, sensory balls to support sensational development in babyhood stage (Oguzkan and Avci, 2000).

*Rattles;* it supports the sense of hearing in babyhood stage.

*Mobiles;* they are toys to develop babies hand-arm movements and intentional learning experiences and they are toys which aim to stimulate visual, aural and touch sensations in babyhood stage.

*Sensory Blankets or Cushions;* they are materials to stimulate babies' visual, aural and touch sensations as supporting their intentional games.

*Pillows;* they are materials to support sensations as vocal and tactile in babies bed or playground.

*Stuffed Toys and Puppets;* they are supportive materials for touch, eyesight and hearing sensations which would be prepared as being sewed or knitted.

## **4.2. Material Samples Which Are Supportive for Sensations towards Children Who Are Three-Six Years Old**

As following babyhood stage, it is necessary to support sensations in early childhood stage. Materials such as sound boxes, scent bottles, touch bags; touch cards are used to support sensations in this stage.

*Sound boxes;* These materials which are involved in Montessori materials support children's aural perception and identification skills as finding the sake two sounds.

*Scent bottles;* They support the development of skills to perceive two same odors and to identify differences between odors for children. Scent bottles are involved in the materials of Montessori.

*Touch bags;* They are materials to support the development of skills for tactile matching and identification as different tactile materials are put in the same-size pouch or bags.

*Touch cards;* Cards that materials in various tissues are used support the development of skills for tactile matching, perception and identification.

## **5.SENSATIONAL ENVIRONMENT**

Daily experiences can strength children's sensations. To train sensations helps these sensations' function to be more active and functional. In order to the training and developing sensations, the organization of home and institutions' setting is important.

### **5.1.Home Setting**

In recent years, there have been recommendations for mother-father in sources as necessary to read books for their babies, to get their babies listen to music, to give interesting picture and objects, to provide toys and different settings and also to select game materials which create problem for babies in order that they would solve it. The communication that mother - after have got it with their babies in this way from first years provide that they support their baby's development through sensations. It is very important for cognitive stimulation as mother and father approach in a way to be sensitive and responsive to their children in terms of affective. Father and mothers should pay attention on their children's need to be stimulated and their development properties. Sometimes, it may be enough to hug children. As mother and father spend time with their children/babies and know them, they would learn cues which reflect that child is tired or is extensively stimulated. All of babies, children and adults have got their own stimulation thresholds. While some of them play for hours, some of them need much more calmness. Thus, there is not a single way to stimulate child (Atli & Beyazit, 2015). It is necessary to organize home setting for this setting. Before parents organize home setting, it is necessary to know which factors are calming for babies ( soft sound, nice odor, soft ray, soft colors, equal heat, daily life routines etc.) or which factors are disturbing for them ( noise, loud noise, strong odors, rapid or unexpected moves , brilliant light and colors, sudden touch, heat changes, unforeseen events etc.). So there are several factors that parents need to assess before organizing home setting. The level of sensational stimulant, number of sensational activities, color varieties, light type, music type, the use of material in different tissue ( fabric, furniture etc.), sound, aroma varieties, the number of passing and awareness are involved in these factors (Emmons and Anderson, 2006; Jewers, Staley, & Shady, 2013; Taygur Altintas & Yilmazer, 2015). These above-stated factors are in factors to be considered in training institutions.

### **5.2.Institution Setting**

Environment which is prepared properly to the development of early childhood and strategies which are applied in the training setting are related to meet children's personal needs and provide sensational experiences for children. However, it is important to know each child's strengths and weaknesses, things that they like or dislike, moment that they are happy or unhappy in order to increase children's sensational experiences. For this purpose, trainer should follow children as routine and he/she should observe them. Because children have got periods that they are sensitive against all of stimulants sometimes. Furthermore, children may not have any response against all of stimulants sometimes and they may have difficulty to make instructions. In this case, there are some points that trainers would use in order to develop positive emotions and to increase sensational awareness for children. To observe the sound level, to follow up routines, to simplify instructions and to recommend proper choices are involved in these points (Isbell & Isbell, 2007; Kranowitz, 2014; Taygur Altintas & Yilmazer, 2015).

### 5.3. Sensation Gardens

Sensation gardens are places where there are rigid, soft, colorful and different tissue, odor and taste materials to stimulate many sensations. Sensation gardens are very important in terms of involving all sensations in it. It is an area where sensational experiences are mostly seen (Hussein, 2012).

## 6. SENSATIONAL ENVIRONMENT AND SENSATIONAL EXPERIENCE'S

Experiences which would be presented for children in these settings by sensations were given at the following.

### 6.1. Sensational Experiences Related to Eyesight

Brilliant, lively, colorful and moving toys can be supplied and games would be played together. Activities related to visual perception, visual memories, visual identification can be done with various objects such as wool, ribbon, toilet paper roll, latch at home. Visual wealth and attraction may be provided for the exploration as training areas are donated with natural, artificial samples and objects. Children's products can be exhibited on walls as well as art poster. Prisms, magnifying glasses, safety mirrors, telescopes, binoculars, hand lamps, sun glasses can be given as sample for materials to provide visual experiences. Children can be taken to bushwalking. Grant children can take magnifying glasses but it may need to direct small children's attention to small things. Patterns of moss, strawberry, insect, shadows, birds or rust on buildings may be presented to the attention of child. Opportunities can be provided to child to touch on peel, dry leaves, sand and cold mud; to review trees which drop leaves, pines' cocoons, needles, humid soil and to smell cold weather. Noise can be presented to child as possible as too much. Short trips between districts, trips to shopping centers, rural area trips and similar activities can be done for them (Casler, 2002; Dunn, 2007; Beyazit & Atlı, 2015; Taygur Altintas & Yilmazer, 2015).

### 6.2. Sensational Experiences Related to Sense of Hearing

Babies can be talked and music can be listened to them from the prenatal period. Music can be listened to them after the birth. But the constant music on background may cause that music gets lost its effect after some time. Thus different music can be listened to baby often but at intervals. It can be provided that children play with vocal toys after birth. Life experiences can be provided in more moving way and in a way to be realized in order that connection is created among sensations by speaking with babies. While hearing experiences are provided, it is important to know when to pass from passive listening to active listening for children. Thus, materials such as stethoscope, tape deck, CD player, ring, music boxes, and rhythm instruments can be used to support the skill of active listening. Different sound in the environment can be recorded. While listening to sounds, records can be paused and then children can be led to listen to them in quiet and to find the source of sound as taking sounds back. Even if small children do not speak, they can listen to sounds that they know the meaning of them and they may like to show picture or drawing which match with their listening. The environment can be prepared for babies in order that they hear various sounds such as animal sounds, vehicle sounds, nature sounds, and household appliances sounds. Sound games would be played with children and song, lullaby and rhyme can be sung together (Casler, 2002; Dunn, 2007; Beyazit & Atlı, 2015; Taygur Altintas & Yilmazer, 2015).

### 6.3. Sensational Experiences Related to Sense of Touch

Games with tactile touch can be played. Gentle and sensitive touches onto belly can be done during the pregnancy. Children's touch senses should not be restricted. Opportunities should be provided to children to touch on their own various body parts such as foot, knee, elbow, back etc. Opportunity can be given to children to play game with objects with different tactile properties (soft, rigid, slippery, rough, feathery, hot etc.). Games with tactile touch can be played. A touch basket can be prepared of objects in different tissues at home. Materials such as soft hairy brushes, board, metal spoons, sponge, pieces of cotton, wrapping papers can be put into this basket. Different tactile fiber, sponge or clothes can be used to massage on child's body during the shower (Casler, 2002; Dunn, 2007; Beyazit & Atlı, 2015; Taygur Altintas & Yilmazer, 2015).

### 6.4. Sensational Experiences Related to Sense of Olfaction

As babies take each kind of odor from the early stage, the opportunity to get nice scents can be given to them and children can be taken to areas with different scents. For example, child can be taken to balcony during the raining. However it should be paid attention that dense odors are put to the places where babies are, as strong odors such as perfume trigger asthma for babies. Soaps which have got different odors in bathroom can be used. It can be talked about odors with children as making massage to children with different-odor lotion and creams during the shower. Games to identify odors can be played with the use of various spices, aroma or scented materials. While cooking in the kitchen, odors of foods can be presented to the attention of child. Odors can be presented to the attention of child in each of ages and their liking can be asked on scents. A wealth area for olfaction can be done in the training environment. Different scents and aromas can be put in the setting. A cup or plate of rose leaves, pine needles, scented bags, incense, dried orange shell or scented soaps can provide nice odor experiences for children (Casler, 2002; Dunn, 2007; Beyazit and Atlı, 2015; Taygur Altintas and Yilmazer, 2015).

### 6.5. Sensational Experiences Related to Sense of Taste

Different foods can be given children to taste them after starting nutritional supplements. When nutritional supplements start, new foods should be given to baby one by one and other food should be given after getting used to one food. In this period, foods in slurry should not be given to child for their taste sensation development. It should be paid attention to prepared delicious foods for children. A tray of foods samples can be prepared for children and these tastes can be categorized in sweet,

sour, hot, cold or salty. Bitter, tasteless or spicy foods can be difficult to be tasted for small children. As children specialized in basic foods, additives or diversifications can be done to it. It is necessary that each of children has got their own spoon. A sweet substance like sugary water can be added to the spoon of children with the use of a drip can and child can be encouraged to think on its taste before they are said about what it is. Different tastes such as orange juice, salty water, lemon juice, cinnamon- vinegar water, chocolate syrup can be used. While giving these tastes, situations such as allergy should be considered (Casler, 2002; Dunn,2007; Beyazit & Atlı, 2015; Taygur Altintas & Yilmazer, 2015).

## 6.6. Sensational Experiences Related to Balance and Move Sense

It is important that babies are in their mothers' arms for skills to catch. For example, babies try to hit items such as scarf, accessory, necklace on mother as she walks and moves. Skill of babies to catch or assess who are walked with an adult develops much more than babies who reach out. Crawling is important for the development of babies' ability to calculate depth and distance. Babies whom the opportunity to crawl is freely given get opportunity to gain many experiences related to height of objects. The opportunity to play with objects in different sizes (a handful dried grape, sand, ball, puzzle etc.) should be given to children. Place and materials to meet children's need to climb, jump kick and walk as they would support their big and small muscle developments. Environment should permit children to creep, crawl, walk and discover in safe and freely. Low shelving's should be chosen so that children can play with material that they would choose (Casler, 2002; Dunn,2007; Beyazit & Atlı, 2015; Taygur Altintas & Yilmazer, 2015).

## 7. ASSESSMENT ON SENSATIONS

Various measurement tools and observation are used properly to children's age and developmental properties by specialists to assess on sensational insufficiency.

### 7.1. Standardized Tests

Standardized tests take less time than observation method. Ayres South California Sensory Integrity Test, Sensory Integrity and Praxis Test and Sensation Profile, Frostig Developmental Visual Perception Test are used commonly to assess on sensations' development. These are briefly explained below.

- **Ayres South California Sensory Integrity Test**, Sensory Integrity Test which was developed by Jean Ayres is used to assess on balance sensation, behaviors to catch position and move in space, awareness on body, touch sensation, motor planning skills, hand-eye coordination and visual identification.
- **Sensory Integrity and Praxis Test**, it was developed by Jean Ayres. It is used to assess on sensory integration of children in four ages- eight age and eleven months. Sensory integration and praxis test review on sensory integrity under the learning and behaviors. This test assess on fields of pattern- background, balance, copying shape, motor sufficiency, tactile stimulating position.
- **Sensation Profile**, it was developed by Winnie Dunn. It is a measurement tool which includes questions related to sensational situations of children and which is applied to persons who provide care in order to determine on children with sensation modulation problems. It consists of two sections as one is sensational process section which consists of aural, visual, vestibular, touch, multiple sensational process and oral sensational process, and modulation section which includes sensational processes related to muscle and movements.
- **Frostig Developmental Visual Perception Test**, it was developed by Marianne Frostig. Test is used to assess on visual perception skills of children at the range of three-dimensioned age. Besides the assessment of visual perception skills belonging children with normal development, it is used to assess on visual perception skills of specific requirement. Frostig Developmental Visual Perception Test has got five sub-dimensions such as eye-motor coordination, pattern-background identification, pattern stability, perception of position in place and perception of spatial relations (Cetin Sultanoglu and Aral, 2015).

### 7.2. Observation

It is the observation and assessment on how children use sensational input during the free game, activity their behaviors during the dinner time, their environmental stimulation level, affective situation, briefly on their interaction with their peers, teachers and family in natural environment (Cetin Sultanoglu and Aral, 2015).

## 8. RECOMMENDATIONS

The beginning of learning starts firstly with sensational organs such as eyesight, hearing, touch, olfactory, taste, and the percept which provides to get the realization of some internal or external stimulants which come to sensational record and reach ( sound, pattern, scent, taste, color, heat, light, darkness, light, image and visibility etc.). The usage of many sensational organs by babies and children affects that information are coded as multiple and also, information are kept in mind, and they become persistent. To be deprived of place which have got wealth to provide necessary sensational experience and opportunity to provide sensation motor-discovering causes significant and persistent mental, social and sensational function disorders in children and babies. Thus opportunities should be given to babies to know their environment through their sensations, to identify differences, to find similarities and to understand relations between objects and support should be provided from the beginning of babyhood.

**REFERENCES**

- [1] Berk, L. E. (2013). Biliş ve dil gelişimi. (Çev. A.Dönmez). Çocuk gelişimi. 272-422. Ankara: İmge Kitapevi.
- [2] Casler, E.N. (2002). Sensory Development. In Ed: N. Salkind (Eds.), Child development (pp.355-357). New York : Macmillan Reference.
- [3] Dunn, W. (2007). Supporting Children to Participate Successfully in Everyday Life by Using Sensory Processing Knowledge. *Infants & Young Children*, 20(2), 84-101.
- [4] Dunn, W., & Daniels, D. B. (2002). İntial Development of the İnfant/Todler Sensory Profile. *Journal of Early Intervention*, 25(1), 27-41.
- [5] Fazlıođlu, Y. Ö. (2004). Duyusal entegrasyon programının otizmli çocukların duyuşal ve davranış problemleri üzerine etkisinin incelenmesi. Doktora tezi, Ankara Üniversitesi Ev Ekonomisi (Çocuk Gelişimi ve Eğitimi) Anabilim Dalı, Ankara.
- [6] Hüssein, H. (2012). The İnfluence of Sensory Gardens on the Behavior of Children with Special Education Needs. *Procedia- Social and Behavioral Sciences*, 38, 343-354.
- [7] Isbell, C., & Isbell, R. (2007). Sensory İntegration. Beltsville: Green Press.
- [8] Jewers, R., Staley, D. and Shady, G. (2013). Sensory processing differences in children diagnosed with tourette's disorder. *Occupational Therapy in Mental Health*, 29, 385-394.
- [9] Kranowitz, C. (2014). Senkronize Olamayan Çocuk. (E. Ş. Baggigo, Çev.) İstanbul: Pepino.
- [10] Özata, S. C. (2015). Okul Öncesinde Oyun Temelli Duyu Eğitimi. Ankara: Nobel.
- [11] Santrock, J. (2014). Yaşam boyu gelişim. (1. Baskı). Ankara: Nobel Yayıncılık.
- [12] Altıntaş, T.T., Yılmaz, Y. (2015). Duyuları Destekleyici Ortam ve Duyu Materyalleri. M.Yıldız Bıçakçı (Ed.), *Duyuların Gelişimi ve Desteklenmesi içinde. Eğiten Kitap*. Ankara
- [13] Atlı, S., Beyazıt, U. (2015). Bebeklik ve İlk Çocukluk Döneminde Duyusal Deneyimler. M.Yıldız Bıçakçı (Ed.), *Duyuların Gelişimi ve Desteklenmesi içinde. Eğiten Kitap*. Ankara.
- [14] Merakı, Z., Yıldız Bıçakçı, M. (2015). Bebeklik ve İlk Çocukluk Döneminde Erken Müdahale. M.Yıldız Bıçakçı (Ed.), *Duyuların Gelişimi ve Desteklenmesi içinde. Eğiten Kitap*. Ankara
- [15] Taştepe, T., Başbay, M.A. (2015). Gelişim Kuramları ve Eğitim Programlarında Duyu Gelişimi. M.Yıldız Bıçakçı (Ed.), *Duyuların Gelişimi ve Desteklenmesi içinde. Eğiten Kitap*. Ankara.
- [16] Tiryaki, Y.A., Baran, G. (2015). Premature Bebekler ve Duyu Gelişimi. M.Yıldız Bıçakçı (Ed.), *Duyuların Gelişimi ve Desteklenmesi içinde. Eğiten Kitap*. Ankara.
- [17] Bee, H. ve Boyd, D. (2009). Çocuk Gelişim Psikolojisi (Çev. Okan Gündüz). İstanbul: Kaktüs Yayınları.

**BIOGRAPHY****Mudriye YILDIZ BIÇAKÇI, Senior Lecturer at Department of Child Development**

University of Ankara, Faculty of Health Sciences

Department of Child Development

Sukriye Mah. Plevne Cad. Aktas Kavsagi. No: 5, Altındag. Ankara

Telephone: 0090 312314 1450

E-Mail: [mudriyebicakci@gmail.com](mailto:mudriyebicakci@gmail.com)

She was born in 1976. Graduated from University of Ankara Faculty of Agriculture, department of Home Economics in 2001. Completed her Master's degree in in 2004 at the department of Faculty of Home Economics (Child Development), and her PhD in 2009 at the same department. She assigned as a research assistant between 2002 to 2010 . She became a assistant professor in 2010, associate professor in 2013. Her working areas and interests are child development, developmental areas different approaches in preschool education. She continues her academic carrier in University of Ankara, Faculty of Health Sciences Department of Child of Child Development.

**2-Hülya TERCAN, Department of Child Development**

Hacettepe University, Faculty of Health Sciences

Department of Child Development

Sihhiye/Ankara

Telephone: 0090 312 305 15 26

E-Mail: [hulya.tercan@hacettepe.edu.tr](mailto:hulya.tercan@hacettepe.edu.tr)

She was born in 1986, completed her undergraduate degree at Hacettepe University, Department of Child Development in 2010. After having Bachelor degree she worked in institutions for kids with special needs as child development worker in Turkey. She took post graduate courses at the audiology department in 2011. Started her Master's Degree in 2015 at the child development department and family counselling department. Currently she is a specialist at Hacettepe University, Department of Child Development.

# Social Media Use Of Large Corporations: Turkey Fortune 500 Analysis

*Merve Turkmen Barutcu<sup>1</sup>, Naciye Guliz Ugur<sup>2</sup>*

---

## Abstract

*In the age of new media and a networked society, online participation and social networking have become an increasingly common development across Turkey as well as the rest of the world. Also this phenomenon continues to transform the way individuals communicate and interact with one another as well as the ways individuals and groups engage with organizations and brands. Social media enables effective communication between organizations and customers, furthermore organizations use social media to increase customer loyalty and brand awareness. Finally, some organizations allocate more of their marketing spending to social media tools. The aim of this study is to enlighten the current status of social media use among top 100 organizations in Turkey's Fortune 500 list, by exploring and describing the organizations' social media platforms in use, follower/like statistics and associated practices with social media. Research data were collected through official web sites and social media accounts of the enterprises and analyzed through quantitative and qualitative methods.*

*Keywords: social media, fortune 500, Turkish enterprise*

---

## 1. INTRODUCTION

For centuries, the development and diffusion of new communication technologies have transformed the communication process among individuals, groups, and the masses. With the advent, proliferation, and technological advancements of the Internet and World Wide Web, a new category of communication technologies emerged: social media. Social media redefined the global landscape and communication habits of both individuals and enterprises. These web-based media are relatively inexpensive, highly accessible, and distinguishable from traditional media in that they facilitate synchronous or asynchronous social interactions involving the sharing of user-generated and user-controlled content with one or many.

Consumers' needs and desires undergo changes thus corporations' search of alternative ways increase in means of satisfying their demands and meeting their expectations. Recently, a new communication tool, social media, has captured the interest of those corporations as an alternative to the existing formal communication channel. Day by day, use of social media by corporations is increasing. Corporations are tweeting, posting, sharing, blogging, and in general using social media tools to communicate with their consumers, employees, and other stakeholders. The growing popularity of social media presents unprecedented opportunities for firms to increase the public awareness (Kaplan and Haenlein, 2010). For some corporations, social media may become the primary communication channel to connect with customers and other stakeholders (Baird & Parasnis, 2011). New social media platforms, such as Facebook, Twitter, YouTube and Instagram, are being adopted by a growing number of entrepreneurs who seek to deploy them for the benefit of their business (Fisher and Reuber, 2011).

The purpose of this study is to analyze which social media networks are being used by corporations and whether adoption differs by industry, firm size, and growth opportunity.

## 2. LITERATURE REVIEW

Social media is the use of mobile and web based technologies to create highly interactive communication (Bhanot, 2012: 47). Social media is a tool for the exchange of information; and it can be an influential component of the consumer's decision making process such as awareness, attitudes, and purchasing (Mangold and Faulds, 2009; Mangold and Smith, 2011). Social media, which begins as an entertainment tool in the beginning, then became the most recent marketing phenomena because of its numerous advantages in business area. Social media serve numerous purposes. Social media has a great impact on corporations activities because of its functions and features related to ensuring effective communication strategies. Social media is used because it has time, stakeholders, relations and cost advantages (Hun, 2010; Kirtiş and Karahan, 2011). According to Hansen, Shneiderman, and Smith (2011), social media technologies have emerged considerably new ways of interacting (Hanna, Rohm and Crittenden, 2011). Corporations have now penetrated the online social media tools, offering direct links from their organizations websites to Facebook and Twitter, and use these tools to introduce brands and support the creation of brand communities (Michaelidou, Siamagka & Christodoulides, 2011; Kaplan & Haenlein, 2010). Some corporations may choose to avoid use social media. Because, many of these corporations do not truly understand how to manage social media effectively. Social media may not be compatible with the marketing strategy of some corporations. Personal selling is a better communication tool than social media platforms (Barnes, 2010).

---

<sup>1</sup> Sakarya University, Department of Business, 54187, Serdivan, Sakarya, Turkey. [mturkmen@sakarya.edu.tr](mailto:mturkmen@sakarya.edu.tr)

<sup>2</sup> Sakarya University, Department of Management Information Systems, 54187, Serdivan, Sakarya, Turkey. [ngugur@sakarya.edu.tr](mailto:ngugur@sakarya.edu.tr)



Web 2.0 technologies are second generation Internet-based services (e.g., wikis, blogs, and social networking sites) (O'Reilly, 2005). Web 2.0 social media platforms like Facebook and Twitter create new opportunities for corporations to improve their internal operations and to collaborate in new ways with their customers, stakeholders and suppliers (Culnan, 2010). Corporations can use these platforms such as Facebook, Twitter, YouTube, and Instagram provide interactive platforms, which require minimum IT skills (Zhou and Pan, 2016).

Corporations' social media tools consist of Facebook, Twitter and Instagram, all used primarily support branding, services and sales. Corporations also increase their awareness through social media tools in community. One study (Burson-Marsteller, 2012) indicates that 87% of global corporations use at least one social media platform, with the most common of these platforms being Twitter (82%), followed by YouTube (79%) and then Facebook (74%) (Go and You, 2016). The social media phenomenon continues to transform the way individuals communicate and interact with one another as well as the ways individuals and groups engage with organizations and brands. Most corporations also use social media's powerful broadcasting function to improve organizational legitimacy (Zhou and Pan, 2016).

The main corporations web sites link to the social media applications such as Facebook, Twitter, Instagram and others. Facebook is the most popular social media platform for users all over the world. Facebook is a wide social media platform for sharing the information in different forms like text-based, image-based, or video-based (Uğur & Barutçu, 2015). Facebook also permits corporations to create business pages that can be used to raise awareness their products and services (Alexander, 2011). Public relations practitioners considered Facebook to be the most important new communications platform in 2010. Next in line were Twitter, LinkedIn, and YouTube (Wright and Hinson, 2010). Twitter is a social networking and microblogging service. Twitter allows a users to follow other members. Also, all users can send and receive tweets using the Twitter (www.wikipedia .com). Instagram is a social media platform in which users can share pictures, photos or videos over their account. It is also primarily a mobile application connected with the Web interface. (Uğur & Barutçu, 2015).

### 3.METHODOLOGY

In this paper we examined among top 100 organizations in Turkey's Fortune 500 list corporations how use the popular social media tools. A content analysis of the corporations web sites maintained by Fortune 500 corporations among the top 100 was conducted. A sample of 100 corporations was selected in 2016 from Fortune list (www.fortuneturkey.com). Between June and July 2016, we gathered data from Fortune 500 corporations on their mainly use of web sites. We visited the web sites of the corporations to reach and evaluate their social media applications. If the company website had a link to the social networking site, then it was included in the analysis.

The Fortune 500 is composed of leading corporations that drive the Turkey economy. Research has shown a continued steady adoption of social media by the top 100 organizations in Turkey's Fortune 500 list.

Many corporations use multiple tools of social media since consumers utilize various platforms for different purposes. Based on the previous literature review, the following research questions are offered:

RQ1: Which social media platforms are being used by corporations?

RQ2: How many corporations have the social media tools in their pages and which of the tools are frequently preferred by the corporations?

RQ3: Are there differences in social media adoption by industry type?

### 4.FINDINGS

Our research findings are based on an analysis of the Fortune 500 corporations' usage frequencies of the most popular social media platforms. This study finds that 62 % of among top 100 organizations in Turkey's Fortune 500 list corporations use social media. 38 % of the samples aren't use social media. 25 % of the corporations use 3 social media platforms (Facebook ,Twitter and Instagram). 25 % of corporations use 2 social media platforms. Among top 10 in Turkey's Fortune 500 list corporations, only 2 corporations are using social media. The rest of the 8 corporations in top 10 aren't related to social media.

Table.1 Number of Social Media Platforms Used by Corporations

Number of Platforms	Used by Firms	
	f	%
0	38	38
1	12	12
2	25	25
3	25	25

Research Question 1 asks which social media platforms are being adopted by corporations. We choose most commonly used social media platforms from corporations. These platforms; Facebook, Twitter and Instagram. Our study found that, Facebook is the most widely used platform (61 %), followed by Twitter (58 %) and Instagram (25 %), as shown in Table 2.

*Table.2 Social Media Platforms Used by Corporations*

Social Media	Used by % of Firms
Facebook	61
Twitter	58
Instagram	25

As it shown in Table.3, In Turkey's Fortune 500 list corporations who have the most followers on Facebook. Turkish Airlines has the most followers, number of over 9 million members. THY is followed by Unilever with over 3,5 million members and Turk Telekom with over 3,3 million members.

*Table.3 Corporations Facebook Followers*

Name of Corporations	Facebook Followers
Turkish Airlines	9.295.734
Unilever	3.563.991
Turk Telekom	3.394.624
Turkcell	2.936.375
Defacto	2.728.591
Teknosa	2.452.744
Pegasus Airlines	1.349.434
Opet Petroleum Inc.	1.310.020
Ülker	1.968.429
Koton	1.186.550

Table.4 indicates that In Turkey's Fortune 500 list corporations who have the most followers on Twitter. THY is the most preferred company on Twitter as Facebook by followers in the Turkey's Fortune 500 list. THY is followed by Turkcell with over 607k members and Teknosa with over 407k members.

*Table.4 Corporations Twitter Followers*

Name of Corporations	Twitter Followers
Turkish Airlines	1.350.414
Turkcell	607.225
Teknosa	407.167
Turk Telekom	316.438
Pegasus Airlines	227.827
Defacto	202.805
Migros	190.016
CarrefourSa	132.454
Koton	100.212
Vestel	79.523

Table.5 indicates that In Turkey's Fortune 500 list corporations who have the most followers on Instagram. Corporations has lower number of followers on Instagram than Facebook and Twitter. As a results, THY is the most preferred company on Instagram with over 600k members. THY is followed by Defacto with over 338k members and Boyner with over 215k members.

*Table.5 Corporations Instagram Followers*

Name of Corporations	Instagram Followers
Turkish Airlines	611.109
Defacto	338.602
Boyner	215.145
Pegasus	78.259
Türk Telekom	61.994
Vestel	25.487
Opet	15.003

Corporations in each industry are using nearly one social media platforms. Whereas, there are differences in which platforms are being used, as shown in Table 6. Corporations were categorized into manufacturing, retail, and service. Also, Table. 6 shows the adoption frequency for each platform by industry. Facebook is the most frequently used (61%), followed by Twitter (58%) and Instagram (24%). However, there are significant industry differences for platforms. In all platforms, Instagram is the least preferred by corporations. Facebook and Twitter are the most frequently used platform in all industries. Manufacturing industry mostly prefers Facebook, on the other hand retail industry mostly prefers Twitter.

Table.6 Social Media Patforms by Industry (Number of Corporations)

Industry	Facebook		Twitter		Instagram	
	Yes	No	Yes	No	Yes	No
<b>Manufacturing (59)</b>	33	26	29	30	9	50
<b>Retail (24)</b>	16	8	17	7	7	17
<b>Service (17)</b>	12	5	12	5	8	9
<b>Total</b>	61	39	58	42	24	76
	(61%)	(39%)	(58%)	(42%)	(24%)	(76%)

Although the 5 corporations which are in the manufacturing industry's and 2 corporations which are in the retail industry's web sites have facebook and twitter logo, they are not connected to the each social media platforms.

## 5.CONCLUSION

Corporations are using social media to communicate with consumers and stakeholders. Social media tools such as Facebook, Twitter and Instagram create new opportunities for corporations. These platforms provide useful information to the corporations about their consumers which are easy to use. The main purpose of this study is to understand Turkey's Fortune 500 List among top 100 corporations prefer which social media platform. Beside that, this study shows us, corporations' followers/likes and which industry uses which social media platform mostly.

Results show us, how corporations' effectively use social media accounts. The primary social media tools considered to be useful for corporations are Facebook, Twitter and Instagram. As shown in Table.2, Facebook has a commanding lead as the most used platform. 61 % of the corporations have Facebook account and 58 % of the corporations have Twitter account as well. The findings indicate that among top 10 organizations in Turkey's Fortune 500 list corporations, only 2 corporations are using Facebook ,Twitter and Instagram. According to findings, the most preferred social media platforms are Facebook, Twitter and Instagram.

Turkish Airlines uses most popular social media platforms Facebook, Twitter and Instagram to build a stronger relationship with their customers. Turkish Airlines is the most followed company in the Fortune Turkey 500 List with over 11 million followers by using social media platforms. THY is followed by Turk Telekom with over 3,7 million followers and Unilever with over 3,5 million followers. Results show us, Retail and service industry's corporations use social media platforms to build a stronger relationship with their customers more than manufacturing industry.

The majority of the corporations don't use effectively social media tools. Whereas, social media can help support your business goals and raise awareness about your brand, products and services. Social media collects a huge amount of data about your customers. Social media tools increases sales and customer retention. Therefore, corporations should effectively use this tools to interact with their customers and other stakeholders through social media.

## REFERENCES

- [1]. (2011). A. Alexander. "Top 9 social media websites for marketers [Web log message]." Retrieved, March, 2, 2016, Available: <http://ansonalex.com/technology/top-9-social-media-websites-for-marketers>.
- [2]. C.H. Baird and G. Parasnis, "From social media to social customer relationship management," *Strategy & Leadership*, 39(5), 30-37, 2011.
- [3]. N.G. "Barnes, Tweeting and blogging to the top," *Marketing Research*, 22(1), 8-13, 2010.
- [4]. S. Bhanot, "Use of social media by companies to reach their customers," *SIES Journal of Management*, March, Vol.8, Issue 1, 2012.
- [5]. J.M. Culnan, J.P. McHugh and I.J. Zubillaga, "How large U.S companies can use twitter and other social media to gain business value," *MIS Quarterly Executive*, Vol.9 No.4 /Dec, 243-259, 2010.
- [6]. E. Fisher and A.R. Reuber, "Social Interaction Via New Social Media: (How) Can Interactions On Twitter Affect Effectual Thinking And Behavior?," *Journal of Business Venturing*, 26, 1-18, 2011.
- [7]. (2016). Fortune 500 Turkiye Retrieved, August 25, 2016, Available: <http://www.fortuneturkey.com/fortune500#popup>
- [8]. E. Go and K. H. You, "But Not All Social Media Are The Same: Analyzing Organizations' Social Media Usage Patterns," *Telematics and Informatics*, 33(1), 176-186, 2016.
- [9]. R. Hanna, A. Rohm and V. L. Crittenden, "We're all connected: The power of the social media ecosystem," *Business Horizons*, 54, 265-273, 2011.
- [10]. D.Hansen, , B.Shneiderman and M. A. Smith, "Analyzing Social Media Networks With Nodexl: Insights From A Connected World," Boston: Elsevier, 2011.
- [11]. (2010). LD.Hun, "Growing popularity of social media and business strategy," [www.seriquarterly.com](http://www.seriquarterly.com). 112-117. Retrieved, August 19, 2016, Available: <http://aeaamp.wikispaces.com/file/view/Growing+Popularity+of+Social.pdf>
- [12]. A. M. Kaplan and M.Haenlein, "Users of the world, unite! The challenges and opportunities of social media." *Business Horizons*, 53(1), 59-68, 2010.
- [13]. A. K. Kirtiş and F. Karahan, "To Be or Not to Be in Social Media Arena as the Most CostEfficient Marketing Strategy after the Global Recession." *Procedia Social and Behavioral Sciences*, (24), 260-268, 2011.

- [14]. W.G. Mangold, and D.J. Faulds, "Social media: The new hybrid element of the promotion mix." *Business Horizons*, 52(4), 357-365, 2009.
- [15]. W.G. Mangold, and K.T. Smith, "Selling to Millennials with online reviews." *Business Horizons*, 55(2), 141-153, 2011.
- [16]. (2012). B. Marsteller, The global social media check-up 2012, Retrieved, August 23, 2016, Available: <http://sites.bursonmarsteller.com/social/Presentation.aspx>
- [17]. N. Michaelidou, N. T. Siamagka and G. Christodoulides, "Usage, barriers and measurement of social media marketing: An exploratory investigation of small and medium B2B brands." *Industrial Marketing Management*, 40, 1153-1159, 2011.
- [18]. (2005). T.O'Reilly, What is Web 2.0: Design patterns and business models for the next generation of software. Available: at <http://www.oreillynet.com/pub/a/oreilly/tim/news/2005/09/30/whatis-web-20.html>
- [19]. (2016). Wikipedia. Retrieved, July 23, 2016, Available: <https://simple.wikipedia.org/wiki/Twitter>
- [20]. (2010). D. Wright and M. Hinson, "How new communications media are being used in public relations: A longitudinal analysis." *Public Relations Journal*, 4(3), Retrieved, June, 12, 2016, Available: <http://www.prsa.org/Intelligence/PRJournal/Documents/2010tWrightHinson.pdf>.
- [21]. H. Zhou and Q. Pan, "Information, Community, and Action on Sina-Weibo: How Chinese Philanthropic NGOs Use Social Media," *Voluntas*, 27, 2433-2457, 2016.

# Mobile Banking Acceptance: A Model Suggestion

*Merve Turkmen Barutcu<sup>1</sup>, Naciye Guliz Ugur<sup>2</sup>*

---

## Abstract

*Mobile phones are the most dominant form of mobile computing; consequently, they have become integral to people's lives. Despite the deep penetration of smartphones, m-banking services are still in their immaturity with great potential for growth in the future. M-banking is one of m-commerce's most value-added applications and has a huge economic impact. The phenomenon is so important that IS professionals have described it as one of the most promising and important developments in the field of mobile commerce and banking. M-banking enables users to acquire real-time account information and make financial transactions at anytime and anywhere. Based on some large group of advantages, banking industry expect that mobile banking will acquire a wide user adoption. However, current user adoption of mobile banking is much lower. The aim of this study is to determine the factors influencing customer acceptance of m-banking applications and also to present the relations between these factors on a theoretical model. The research model is developed with the integration of three major theories; Task Technology Fit (TTF), Unified Theory of Acceptance and Use of Technology (UTAUT) and ITM (Initial Trust Model) to examine the mechanisms behind the adoption of m-banking. This paper offers valuable insights to decision-makers involved in the implementation and deployment of m-banking services.*

**Keywords:** Mobile Banking, Technology Adoption, TTF, UTAUT, ITM

---

## 1. INTRODUCTION

With the improvement of mobile technologies and devices, mobile banking has been considered as a salient system because of such attributes of mobile technologies as ubiquity, convenience and interactivity (Turban, King, Viehland, & Lee, 2006). The wide penetration and personal nature of mobile phones, the overall stability of mobile communication technologies, and the positive experiences with m-commerce payments have made mobile solutions applicable for a variety of financial services. Current mobile financial applications include mobile banking and a variety of different micropayment solutions. Today, mobile payments are mainly used to pay for popular mobile content and services since there are few alternative payment solutions available. Other successful applications include ticketing and vending (Mallat et al., 2004). In the development of mobile banking, banks enable users to access account balances, pay bills, and transfer funds through cell phone or other mobile device, instead of visiting banks and internet banking based on computer (Gu et al., 2009).

Mobile banking services are valued by users because of the inherent time and place independence, and the overall effort-saving qualities (Suoranta, 2003). More generally, security and convenience have been suggested as the key drivers for the growth of mobile commerce (Jarvenpaa et al, 2003; Tsalgatidou & Pitoura, 2001). Personal mobile devices are effective in identifying the payer and confirming the transaction (Mallat et al., 2004). This trend of mobile banking indicates a remarkable potential to the banking industry. Banks can retain existing banking users in providing a new system (mobile banking) into the existing systems and have an opportunity to convert cell phone users into banking users. Nevertheless, retaining mobile banking users and attracting new ones may not be easy (Devaraj, Fan, & Kohli, 2002; Gefen, Karahanna, & Straub, 2003). Therefore, it is important to understand what factors contribute to users' intention to use mobile banking.

## 2. ACCEPTANCE OF M-BANKING

During the last two decades, many researchers have used Technology Acceptance Model (TAM) to explain an individual's acceptance of new Information Technology (IT) and verified that the perceived usefulness and the perceived ease-of-use are key constructs of individual acceptance (Adams, Nelson, & Todd, 1992; Agarwal & Karahanna, 2000; Davis, 1989; Davis, Bagozzi, & Warshaw, 1989; Doll, Hendrickson, & Deng, 1998; Hendrickson, Massey, & Cronan, 1993; Mathieson, 1991; Segars & Grover, 1993). However, these two factors may not exactly reflect the acceptance of mobile banking users (Hsu & Lu, 2004). While the TAM has many strengths, including its specific focus on IS use, its basis in social psychology theory, the validity and reliability of its instruments and its parsimony, one of its limitations is the assumption that its use is volitional; in other words, there are no barriers to prevent an individual from using an IS if he or she chose to do so (Mathieson, Peacock, & Chin, 2001). There may be situations in which an individual wants to use an IT, but is prevented by lack of time, money or expertise (Mathieson, 1991; Mathieson et al., 2001; Taylor & Todd, 1995a, 1995b; Chau & Hu, 2001).

The previous research has tried to explain mobile user adoption based on user perceptions of the technology such as perceived usefulness and perceived ease of use (Aldas-Manzano, Ruiz-Mafe, & Sanz-Blas, 2009; Ha, Yoon, & Choi, 2007; Jung, Perez-Mira, & Wiley-Patton, 2009; Kuo & Yen, 2009; Mallat, Rossi, Tuunainen, & Oorni, 2009; Shin, 2009), relative advantage, compatibility (Chen, Yen, & Chen, 2009; Hsu, Lu, & Hsu, 2007; Wu & Wang, 2005), and interactivity (Lee, 2005). However,

---

<sup>1</sup> Sakarya University, Department of Business, 54187, Serdivan, Sakarya, Turkey. [mturkmen@sakarya.edu.tr](mailto:mturkmen@sakarya.edu.tr)

<sup>2</sup> Sakarya University, Department of Management Information Systems, 54187, Serdivan, Sakarya, Turkey. [ngugur@sakarya.edu.tr](mailto:ngugur@sakarya.edu.tr)

simply focusing on user perceptions of the technology may be not enough. The task technology fit (TTF) model argues that individuals will adopt a technology based on the fit between the technology characteristics and task requirements (Goodhue, 1995; Goodhue & Thompson, 1995). It is possible that, although users perceive a technology as being advanced, they do not adopt it if they think this technology is unfit with their tasks and cannot improve their performance (Junglas, Abraham, & Watson, 2008; Lee, Cheng, & Cheng, 2007). In other words, these users may be utilitarian, and their adoption is not only determined by their perception and attitudes toward the technology but also by a good task technology fit. Due to the great uncertainty and risk involved in online transactions, trust has received considerable attention in the electronic commerce context. Trust has been found to affect user adoption of various services, such as online news services (Chen and Corkindale, 2008), Internet banking (Flavian et al., 2005), health web sites (Fisher et al., 2008), and mobile shopping (Lu and Su, 2009). Trust includes initial trust and continuance trust. As the first stage of trust development, initial trust is significant for user behavior and various factors have been identified to affect initial trust. This research integrates the unified theory of acceptance and usage of technology (UTAUT) (Venkatesh et al., 2003) initial trust model (ITM) (McKnight et al. 1998), and TTF to explain user adoption of mobile banking from both perspectives including technology perception and task technology fit. Our results showed that user behavior is indeed significantly influenced by both types of factors.

### 3.LITERATURE REVIEW

Researchers have examined mobile banking, an emergent mobile service, from the perspectives of trust, TAM, and the theory of planned behavior (TPB). Kim, Shin, and Lee (2009) examined the effect of initial trust on mobile banking user adoption. They identified the determinants of initial trust including relative benefits of mobile banking, structural assurances, firm reputation, and a user's trust propensity. TAM and TPB have been used to identify possible factors affecting mobile banking users' behavioral intention (Luarn & Lin, 2005). These factors include perceived usefulness, perceived ease of use, perceived credibility, self-efficacy, and perceived financial cost (Luarn & Lin, 2005). In addition to perceived credibility, facilitating conditions and demographic factors also have obvious effects on mobile banking adoption (Crabbe, Standing, Standing, & Karjaluoto, 2009).

Of particular interest to the current study is m-banking acceptance, a fundamental managerial challenge in the implementation of mobile banking. Thus, a review of prior studies suggested the theoretical foundations of the formulations used in our hypotheses. To this end, this study examines three prevalent theories (i.e., UTAUT, ITM and TTF) for investigating individual acceptance of mobile banking.

#### Unified Theory of Acceptance and Usage of Technology

As an extension to TAM, UTAUT was proposed by Venkatesh et al. in 2003. They found that user adoption and usage of an information technology are influenced mainly by four factors: performance expectancy, effort expectancy, social influence, and facilitating conditions (Venkatesh et al., 2003).

Although UTAUT has not been as widely used as TAM, it has gradually drawn researchers' attentions and has been recently applied to exploring user acceptance of mobile technologies (Carlsson, Carlsson, Hyvonen, Puhakainen, & Walden, 2006; Min, Ji, & Qu, 2008; Park, Yang, & Lehto, 2007). Performance expectancy and effort expectancy are found to be the main determinants of behavioral intention in using mobile services in Finland (Carlsson et al., 2006). The UTAUT model has also been revised to study mobile commerce acceptance (Min et al., 2008). In addition to the original determinants, trust, privacy, convenience, and cost are also shown to affect the behavioral intention (Min et al., 2008). Moreover, gender and education have significant moderation effects on user adoption (Park et al., 2007).

UTAUT has drawn attention of researchers and has been used in different research settings to study behavior intention and technology adoption. Hong, Thong, Chasalow, and Dhillon (2011) considered UTAUT as an influential theory in the IS adoption context and used it to conceptualize a model to study agile IS adoption. Luo, Li, Zhang, and Shim (2010) analyzed the impact of trust, risk, self-efficiency and performance expectancy in m-Banking adoption. They concluded that the performance expectancy is the most significant determining factor in the m-Banking services acceptance (Oliveira et al., 2014).

#### Initial Trust Model

McKnight et al. (2002a) proposed a model to predict initial user trust in an e-vendor by drawing on existing trust research from the management literature (Lewicki & Bunker, 1995; Mayer et al., 1995) and integrating it within the framework of Theory of Reasoned Action (TRA) (Fishbein & Ajzen, 1975). McKnight et al. (2002a, 1998) defined initial trust as trust in an unfamiliar party. Initial trust is the willingness of a person to take risks in order to fulfill a need without prior experience, or credible, meaningful information (Kim & Prabhakar, 2004; McKnight & Chervany, 2001). Convenience, flexibility, and perceived benefits such as the role of service usefulness contribute to the formation of initial trust (Koufaris & Hampton-Sosa, 2004). For example, before having direct interaction with an information system in a specific context, a trustor can build initial trust in this system based on their experiences with other systems, their knowledge about this system used in other contexts, and/or others' opinions about the system (Li et al., 2008). The level of initial trust in a service is a function of diverse forces. McKnight et al. (1998) categorized them into institution-, personality- and cognition-based factors. Initial trust may be affected by structural or environmental conditions and situational normality, frequently termed as institution-based trust factors (McKnight et al., 2002a). Initial trust in a trustee or a service may also be affected by a trustor's personality, including his/her propensity to trust (Gefen, 2000). In addition, such firm characteristics as size, capability, integrity, role in the market- place, benevolence, reputation and brand may affect a person's perception of a firm's services or products (Jarvenpaa et al., 2000; McKnight et al., 2002a; 2004). Finally, there are structural assurances that may be particularly relevant to e-commerce in enhancing service trustworthiness. These include the availability of service guarantees, privacy policies, endorsement and third-party recognition (Siau & Shen, 2003; McKnight et al., 2004).

## Task Technology Fit

The TTF adoption model suggests that the user will adopt a new technology if it is good enough to execute the daily task efficiently. Hence, the adoption to a new information system will depend greatly on the users' daily tasks (Goodhue & Thompson, 1995). This model explains adoption using four constructs – task characteristics, technology characteristics, task technology fit, and use. The task characteristics and technology characteristics determine the task technology fit which leads to the adoption and use of the information system (Oliveira et al., 2014). Since its inception, TTF has been widely used and combined with other models such as TAM to explain user adoption of an information technology (Dishaw & Strong, 1999).

TTF has been applied to explain user adoption of emerging Internet services such as blogs (Shang, Chen, & Chen, 2007). Empirical evidence shows that the interaction between task and technology characteristics affects users' evaluation of blogs, which further determines their usage (Shang et al., 2007). TTF has also been used to explain user adoption of mobile technologies such as location-based systems (LBS) (Junglas et al., 2008) and mobile insurance (Lee et al., 2007).

A good task technology fit will promote user adoption of mobile banking. In contrast, a poor task technology fit will decrease users' adoption intention (Lee et al., 2007; Lin & Huang, 2008). For example, although mobile banking has many advantages such as ubiquity and immediacy, if users do not require mobile transactions (for example, they are mostly in the office and have a low demand for mobile payments), they will select traditional or online banking services rather than mobile banking. Previous research also suggests the importance of task technology fit on user adoption (Zhou et al., 2010).

## 4. RESEARCH MODEL

Existing theoretical and empirical studies imply that people's initial trust and UTAUT in mobile banking is vital for its individual and social acceptance. A research model (Figure 1) is proposed to examine how selected antecedents affect the formation of an individual's adoption of mobile banking and how these antecedents lead to his/her intention to make use of the service.

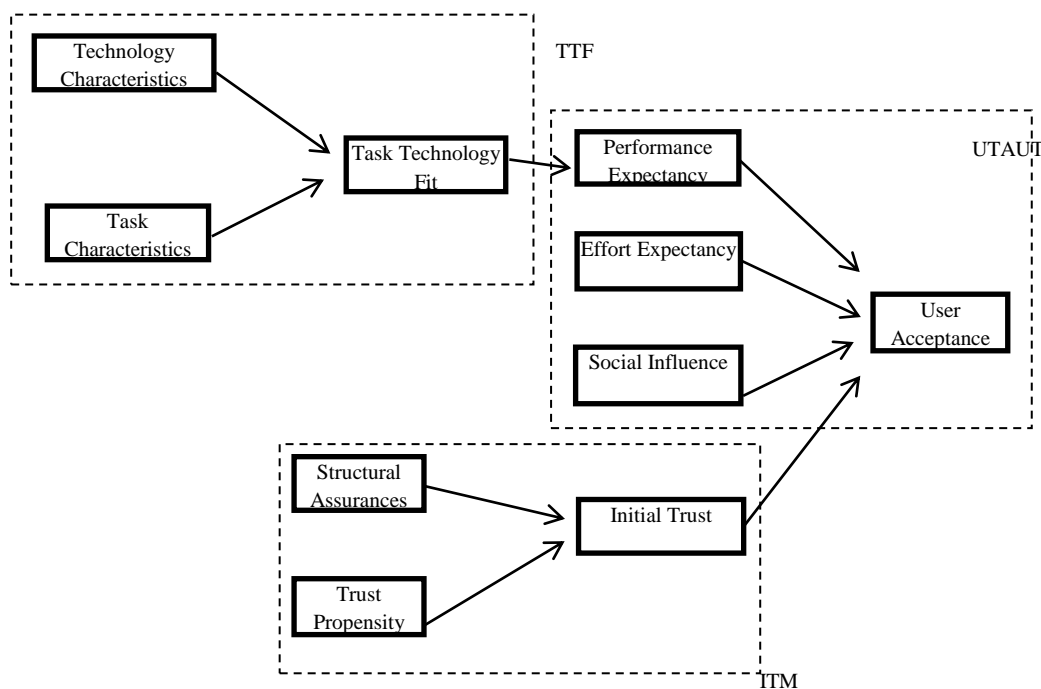

Figure 1: Research Model

### Structural Assurances

Structural assurances in the form of agreements, contracts, regulations, policies, laws, feedback forums, guarantees, escrow services and others enhance initial trust between involved parties in a relationship (Zucker, 1986; McKnight et al., 2004; Pavlou & Gefen, 2004). People understand that there are uncertainties and risks associated with online business channels because the information asymmetry between buyers and sellers can result in opportunistic behaviours. The availability of formalized structural assurances that discourage such opportunistic behaviours is vital to build confidence in m-commerce services such as mobile banking (Kim & Prabhakar, 2004). Institutional formalities are necessary for the successful formation of client trust in online businesses, particularly in the initial stage of business engagements (McKnight et al., 1998); Pennington et al., 2003). In this study, therefore, we examine the effects of various structural assurances offered by mobile banking firms, which include compensation for financial losses because of service faults and the protection of customer information and privacy.

Compared to online banking, mobile banking is built on mobile networks and may be more vulnerable to hacker attack and information interception. Viruses and Trojan horses may also exist in mobile terminals. These problems will incur users'

concern on their account and payment security. Structural assurance as an institution-based trust mechanism has been found to affect users' initial trust (McKnight et al., 2002b). Especially, due to the lack of direct experience, users may rely much on these structural assurances to build their trust in mobile banking. According to trust transference mechanism, users will transfer their trust in third parties to mobile banking (Pavlou and Gefen, 2004).

### **Trust Propensity**

Trust propensity represents a person's disposition to rely on others in various situations (McKnight et al., 1998). It is deeply rooted in a person's personality and psychological development during the early stage of her/his life (Lee & Turban, 2001). According to the social learning theory, social interactions with people such as parents in early childhood play a vital role in shaping a person's trust propensity (Rotter, 1967). McKnight et al. (1998) divided trust disposition into two types: faith in humanity, in which a person believes in the reliability and dependability of people; and trusting stance, in which a person believes that he or she will be better off when he or she deals with people as if they are reliable.

An individual's trust tendency thus formed plays a role in determining initial confidence in his/her business counterpart. For example, it has been shown that trust propensity affects investors' beliefs about the trustworthiness of brokerages and their services (Menon et al., 1999). Those users with high trust propensity tend to have positive attitudes towards new technologies. Thus they will more readily build trust in mobile banking. In contrast, those users with low trust propensity may doubt the credibility of mobile banking, which represents an emerging service.

### **Initial Trust**

Trust reflects a willingness to be in vulnerability based on the positive expectations towards another party's future behavior (Mayer et al., 1995). Trust often includes three dimensions: ability, integrity and benevolence (Benamati et al., 2010). Ability means that mobile service providers have enough knowledge and skills to fulfill their tasks. Integrity means that mobile service providers keep their promises and do not deceive users. Benevolence means that mobile service providers will concern users' interests, not just their own interests.

### **Technology Characteristics**

In this model, technology characteristics refer to the technology used by individuals to perform their tasks. For example, the computer systems and mobile devices that is possible to support users in their tasks. Technology characteristics reflect characteristics of mobile banking including ubiquity, immediacy, and security (Goodhue and Thompson, 1995).

### **Task Characteristics**

M-Banking uses wireless technologies to provide users ubiquitous, real-time service with the help of protocols such as General Package Radio Services (GPRS) and Code Division Multiple Access (CDMA). M-Banking gives users mobility, access and readiness to banking services that are not available via online or traditional brick-and-mortar services. Technology makes m-Banking attractive to users on the go, by enabling common banking tasks such as account management, brokerage and financial inquiries both accessible and convenient. Hence, the task characteristics and the technology characteristic of m-Banking results in a higher task technology fit.

### **Task Technology Fit**

Task technology fit is the rational perspective of what a new technology can do to optimize a job. It is affected by the nature of the task and practicality of the technology to complete the task. Thus TTF influences the attitude of the user toward m-Banking and the adoption of m-Banking.

### **Performance Expectancy**

Performance expectancy is defined as the degree to which an individual believes that using the system will help attain gains in job performance (Venkatesh et al., 2003). It reflects user perception of how difficult it is to use mobile banking. According to UTAUT, effort expectancy positively affects performance expectancy (Venkatesh et al., 2003). When users feel that mobile banking is easy to use and does not require much effort, they will have a high expectation toward acquiring the expected performance. Otherwise, their performance expectancy will be low Luo et al. (2010) and Riffai, Grant, and Edgar (2012) concluded that performance expectancy is a key factor for a user to accept the m-Banking technology. Performance expectancy implies that the user realizes gains from the use of m-Banking. It bears resemblance to the perceived usefulness construct from TAM (Kim et al., 2009; Martins, Oliveira, & Popovic, 2014; Miltgen, Popovic, & Oliveira, 2013). The value to customers from m-Banking can be more than those available from Internet based or brick-and-mortar based services. Such benefits include convenience, satisfaction, economic benefits, and personal image (Rogers, 1995; Taylor & Todd, 1995).

### **Effort Expectancy**

Effort expectancy is defined as the degree of ease associated with the use of the system (Venkatesh et al., 2003). This construct reflects the perceived ease of use (TAM) of an IS (Kuo & Yen, 2009; Luarn & Lin, 2005; Martins et al., 2014; Miltgen et al., 2013; Wang, Lin, & Luarn, 2006) and has a positive impact on the behavioral intention. User interfaces, content design, and functional ability (Kim et al., 2009; Venkatesh et al., 2003) of m-Banking can influence its adoption.

### **Social Influence**

Social influence is a direct antecedent of behavioral intention. Venkatesh et al. (2003) defines social influence as the degree to which an individual perceives that it is important for others to believe that he or she uses the new technology or complies with



others' expectations. It is the notion that individual behavior is influenced by the way peers or family members value the use of m-Banking. The individual may feel trendy and professional by using a new service technology such as m-Banking.

## 5.CONCLUSION

As an emerging service, mobile banking has not been widely adopted by users. Thus researchers have paid attention to identify the factors affecting user adoption. Information technology adoption theories such as TAM, ITM and UTAUT are often used as the theoretical bases. Gu et al. (2009) found that structural assurance and perceived ease of use affect trust in mobile banking. Lin (2011) drew on IDT and trust theory to examine the effects of innovation attributes and knowledge-based trust on mobile banking adoption. Innovation attributes include relative advantage, compatibility and perceived ease of use. Knowledge-based trust includes perceived competence, benevolence and integrity. Kim et al. (2009) reported that structural assurance, relative benefits and personal propensity to trust affect initial trust in mobile banking. Zhou et al. (2010) integrated UTAUT and task technology fit theory to examine user adoption of mobile banking. Luo et al. (2010) found that performance expectancy and perceived risk have significant effects on the intention to use mobile banking services.

The research model presented in this paper is unique in that it combines the task technology fit, initial trust and UTAUT in evaluating the decision to adopt m-Banking. This study makes important contributions for research and practice. For researchers, the model presents a holistic approach to examine the factors that influence m-Banking adoption by combining three established theories namely, TTF, UTAUT and ITM. By establishing the relationship between the users' perceptions of the new technology, task technology fit in fulfilling banking needs, initial trust in m-Banking services, and the adoption of m-Banking, the study makes new contribution to the published literature. For practitioners, it offers valuable insights into the role of technology in service delivery. More notably, it offers a pragmatic view of the behavioral and technological factors that are imperative to the decision to adopt m-Banking. The study can help financial institutions optimize their m-Banking initiatives, implementation and deployment.

## REFERENCES

- [1]. D. A., Adams, R. R., Nelson and P. A. Todd, "Perceived Usefulness, Ease of Use, and Usage of Information Technology: a Replication," *MIS Quarterly*, 16(2), 227-247, 1992.
- [2]. R., Agarwal, and E. Karahanna, "Time Flies When You're Having Fun: Cognitive Absorption and Beliefs about Information Technology Usage," *MIS Quarterly*, 24(4), 665-694, 2000.
- [3]. J., Aldas-Manzano, C., Ruiz-Mafe, and S. Sanz-Blas, "Exploring Individual Personality Factors as Drivers of m-Shopping Acceptance," *Industrial Management & Data Systems*, 109(6), 739-757, 2009.
- [4]. J.S., Benamati, Fuller, M.A. Serva, and J.A. Baroudi, "Clarifying The Integration of Trust and TAM in e-Commerce M.A., Environments: Implications for Systems Design and Management," *IEEE Transactions on Engineering Management*, Vol. 57 No. 3, pp. 380-93, 2010.
- [5]. C., Carlsson, J., Carlsson, K., Hyvonen, J. Puhakainen and P. Walden, "Adoption of Mobile Devices/Services-Searching for Answers with the UTAUT," *In Proceedings of the 39th Hawaii international conference on system sciences*, 2006.
- [6]. P. Y. K., Chau and P. J.-H. Hu, "Information Technology Acceptance by Individual Professionals: A Model Comparison Approach," *Decision Sciences*, 32(4), 699-719. 2001.
- [7]. Y.H.H. Chen and D. Corkindale, "Towards an Understanding of the Behavioral Intention to use Online News Y.H.H. Services: an Exploratory Study," *Internet Research*, Vol. 18 No. 3, pp. 286-312, 2008.
- [8]. Chen J. V., D. C., Yen and K.Chen, "The Acceptance and Diffusion of the Innovative Smart Phone Use: A Case Study of a Delivery Service Company in Logistics," *Information & Management*, 46(4), 241-248, 2009.
- [9]. M., Crabbe, C., Standing, S., Standing and H.Karjaluo, "An Adoption Model for Mobile Banking in Ghana," *International Journal of Mobile Communications*, 7(5), 515-543, 2009.
- [10]. F. D. Davis, "Perceived Usefulness, Perceived Ease of Use, and User Acceptance of Information Technology," *MIS Quarterly*, 13(3), 318-339, 1989.
- [11]. L. D., Davis, R. P., Bagozzi and P. R. Warshaw, "User Acceptance of Computer Technology: A Comparison of Two Theoretical Models," *Management Science*, 35(8), 982-1003, 1989.
- [12]. S., Devaraj, M., Fan and R. Kohli, "Antecedents of B2C Channel Satisfaction and Preference: Validating e-Commerce Metrics," *Information Systems Research*, 13(3), 316-334, 2002.
- [13]. M. T., Dishaw, and D. M. Strong, "Extending the Technology Acceptance Model with Task-Technology Fit Constructs," *Information & Management*, 36(1), 9-21, 1999.
- [14]. W. J., Doll, A., Hendrickson and X. Deng, "Using Davis's Perceived Usefulness and Ease-of-Use Instruments for Decision Making: A Confirmatory and Multi-Group Invariance Analysis," *Decision Science*, 29(4), 839-869, 1998.
- [15]. Fishbein, and I. Ajzen, "Belief, Attitude, Intention and Behavior: An Introduction to Theory and Research," M. Addison-Wesley, Reading, MA., 1975.
- [16]. J., Fisher, F., Burstein, K. Lynch, and K. Lazarenko, "'Usability Plus Usefulness ¼ Trust': an Exploratory Study of Australian Health Web Sites," *Internet Research*, Vol. 18 No. 5, pp. 477-98, 2008.
- [17]. C., Flavian, M. Guinaliu, and E. Torres, "The Influence of Corporate Image on Consumer Trust – a Comparative Analysis in Traditional Versus Internet Banking," *Internet Research*, Vol. 15 No. 4, pp. 447-70, 2005.
- [18]. D., Gefen, D. W., Straub and M. C.Boudreau, "Structural Equation Modelling and Regression: Guidelines for Research Practice," *Communications of the Association for information Systems*, 4, 1-70, 2000.
- [19]. D., Gefen, E., Karahanna and D. W. Straub, "Trust and TAM in Online Shopping: An Interacted Model," *MIS Quarterly*, 27(1), 51-90, 2003a.
- [20]. D. L. Goodhue, "Understanding User Evaluations of Information Systems," *Management Science*, 41(12), 1827-1844, 1995.
- [21]. D. L., Goodhue and R. L. Thompson, "Task-technology fit and individual performance," *MIS Quarterly*, 19(2), 213-236, 1995.
- [22]. J.-C., Gu, S.-C. Lee, and Y.-H. Suh, "Determinants of Behavioral Intention to Mobile Banking, Expert Systems with Applications," Vol. 36 No. 9, pp. 11605-16, 2009.
- [23]. I., Ha, Y., Yoon and M. Choi, "Determinants of adoption of Mobile Games Under Mobile Broadband Wireless Access Environment," *Information & Management*, 44(3), 276-286, 2007.
- [24]. A. R., Hendrickson, P. D., Massey and T. P. Cronan, "On the Test-Retest Reliability of Perceived Ease of Use Scales," *MIS Quarterly*, 17(2), 227-230, 1993.

- [25]. S.-J. Hong, J. Y. L., Thong, J.-Y., Moon and K. Y. Tam, "Understanding the behavior of mobile data services Consumers," *Information Systems Frontier*, 10(4), 431-445, 2008.
- [26]. C. L., Hsu and H. P. Lu, "Why do people play on-line games? An extended TAM with Social Influences and Flow Experience," *Information and Management*, 41(7), 853-868, 2004.
- [27]. C.-L. Hsu, H.-P. Lu and H.-H. Hsu, "Adoption of the Mobile Internet: An Empirical Study of Multimedia Message Service (MMS)," *Omega*, 35(6), 715-726, 2007.
- [28]. S. L., Jarvenpaa, K. R., Lang, Takeda Y. and V. K. Tuunainen, "Mobile Commerce at Crossroads," *Communications of the ACM*, 46, 41-44, 2003.
- [29]. S. L., Jarvenpaa, N., Tractinsky and M. Vitale, "Consumer Trust in an Internet Store," *Information Technology and Management*, 1, 45-71, 2000.
- [30]. Y., Jung, B., Perez-Mira and S. Wiley-Patton, "Consumer Adoption of Mobile TV: Examining Psychological Flow and Media Content," *Computers in Human Behavior*, 25(1), 123-129, 2009.
- [31]. I., Junglas, C., Abraham and R. T. Watson, "Task-Technology Fit for Mobile Locatable Information Systems," *Decision Support Systems*, 45(4), 1046-1057, 2008.
- [32]. I. A., Junglas and R. T. Watson, "Location-Based Services," *Communications of the ACM*, 51(3), 65-69, 2008.
- [33]. K. K. Kim and B. Prabhakar, "Initial Trust and the Adoption of B2C e-Commerce: the Case of Internet Banking," *ACM SIGMIS Database*, 35, 50-64, 2004.
- [34]. B., Kim, Shin and H. G. Lee, "Understanding Dynamics Between Initial Trust and Usage Intentions of Mobile G., Banking," *Information Systems Journal*, 19, 283-311, 2009.
- [35]. M., Koufaris and W. Hampton-Sosa, "The Development of Initial Trust in an Online Company by New Customers," *Information & Management*, 41, 377-397, 2004.
- [36]. Y.-F., Kuo and S.-N. Yen, "Towards an Understanding of the Behavioral Intention to Use 3G Mobile Value-Added Services," *Computers in Human Behavior*, 25(1), 103-110, 2009.
- [37]. C. C., Lee, H. K., Cheng and H. H. Cheng, "An empirical study of mobile commerce in Insurance Industry: Task-Technology Fit and Individual Differences," *Decision Support Systems*, 43(1), 95-110, 2007.
- [38]. M., Lee and E. Turban, "A Trust Model for Consumer Internet Shopping," *International Journal of Electronic Commerce*, 6, 75-91, 2001.
- [39]. T. Lee, 2005. "The impact of perceptions of interactivity on customer trust and transaction intentions in mobile commerce," *Journal of Electronic Commerce Research*, 6(3), 165-180.
- [40]. Lewicki, R. J., Bunker, B. B., 1995. "Trust in relationships: a model of development and decline," In: Bunker, B. B., Rubin, J. Z. (Eds.), Conflict, Cooperation and Justice. Jossey-Bass, San Francisco, pp. 133-173.
- [41]. Lin, T.-C., & Huang, C.-C. (2008). Understanding knowledge management system usage antecedents: An integration of social cognitive theory and task technology fit. *Information & Management*, 45(6), 410-417.
- [42]. Lu, H.-P. and Su, P. Y.-J. (2009), "Factors affecting purchase intention on mobile shopping web sites", *Internet Research*, Vol. 19 No. 4, pp. 442-58.
- [43]. Luarn, P., & Lin, H. H. (2005). Toward an understanding of the behavioral intention to use mobile banking. *Computers in Human Behavior*, 21, 873-891.
- [44]. Luo, X., Li, H., Zhang, J., & Shim, J. P. (2010). Examining multi-dimensional trust and multi-faceted risk in initial acceptance of emerging technologies: An empirical study of mobile banking services. *Decision Support Systems*, 49, 222-234.
- [45]. Mallat, N., Rossi, M. & Tuunainen, V. K. (2004) Mobile banking services. *Communications of the ACM*, 47, 42-46.
- [46]. Mallat, N., Rossi, M., Tuunainen, V. K., & Oorni, A. (2009). The impact of use context on mobile services acceptance: The case of mobile ticketing. *Information & Management*, 46(3), 190-195.
- [47]. Martins, C., Oliveira, T., & Popovic, A. (2014). Understanding the Internet banking adoption: A unified theory of acceptance and use of technology and perceived risk application. *International Journal of Information Management*, 34, 1-13.
- [48]. Mathieson, K. (1991). Predicting user intentions: Comparing the technology acceptance model with the theory of planned behavior. *Information System Research*, 84(1), 123-136.
- [49]. Mathieson, K., Peacock, E., & Chin, W. W. (2001). Extending the technology acceptance model: The influence of perceived user resources. *DATA BASE for Advances in Information Systems*, 32(3), 86-112.
- [50]. Mayer, R. C., Davis, J. H., Schoorman, F. D., 1995. An integrative model of organizational trust. *The Academy of Management Review* 20 (3), 709-734.
- [51]. McKnight, D. H., Chervany, N. L. (2001). What trust means in e-commerce customer relationships: An interdisciplinary conceptual typology. *International Journal of Electronic Commerce*, 6, 35-59.
- [52]. McKnight, D. H., Choudhury, V. and Kacmar, C. (2002a), "Developing and validating trust measures for e-commerce: an integrative typology", *Information Systems Research*, Vol. 13 No. 3, pp. 334-59.
- [53]. McKnight, D. H., Choudhury, V. and Kacmar, C. (2002b), "The impact of initial consumer trust on intentions to transact with a web site: a trust building model", *The Journal of Strategic Information Systems*, Vol. 11 Nos 3-4, pp. 297-323.
- [54]. McKnight, D. H., Cummings, L. L. & Chervany, N. L. (1998) "Initial trust formation in new organization relationships." *Academy of Management Review*, 23, 473-490.
- [55]. McKnight, D. H., Kacmar, C. J., & Choudhury, V. (2004). "Shifting factors and the ineffectiveness of third party assurance seals: A two-stage model of initial trust in a web business". *Electronic Markets*, 14, 252-266.
- [56]. Menon, N. M., Konana, P., Browne, G. J. & Balasubramanian, S. (1999) "Understanding trustworthiness beliefs in electronic brokerage usage." *Proceedings of the Twentieth Information Conference on Information Systems*. 552-555.
- [57]. Miltgen, C. L., Popovic, A., & Oliveira, T. (2013). "Determinants of end-user acceptance of biometrics: Integrating the Big 3 of technology acceptance with privacy context." *Decision Support Systems*, 56, 103-114.
- [58]. Min, Q., Ji, S., & Qu, G. (2008). "Mobile commerce user acceptance study in China: A revised UTAUT model." *Tsinghua Science & Technology*, 13(3), 257-264.
- [59]. Oliveira, T., Faria, M., Thomas, M. A., & Popović, A. (2014). "Extending the understanding of mobile banking adoption: When UTAUT meets TTF and ITM." *International Journal of Information Management*, 34(5), 689-703.
- [60]. Park, J., Yang, S., & Lehto, X. (2007). "Adoption of mobile technologies for Chinese consumers." *Journal of Electronic Commerce Research*, 8(3), 196-206.
- [61]. Pavlou, P. A. & Gefen, D. (2004) "Building effective online marketplaces with institution based trust." *Information Systems Research*, 15, 37-59.
- [62]. Pennington, R., Wilcox, H. D. & Grover, V. (2003) "The role of system trust in business-to-consumer transactions" *Journal of Management Information Systems*, 20, 197-226.

- [63]. Riffai, M. M. M. A., Grant, K., & Edgar, D. (2012). "Big TAM in Oman: Exploring the promise of on-line banking, its adoption by customers and the challenges of banking in Oman." *International Journal of Information Management*, 32, 239–250.
- [64]. Rogers, E. (1995). "Diffusion of innovations." In. New York: Free Press
- [65]. Rotter, J. (1967) "A new scale for the measurement of interpersonal trust." *Journal of Personality*, 35, 651– 665.
- [66]. Segars, A. H., & Grover, V. (1993). "Re-examining perceived ease of use and usefulness: A confirmatory factors analysis." *MIS Quarterly*, 17(4), 517–526.
- [67]. Shang, R. A., Chen, Y. -C. & Chen, C.-M. (2007). "Why people blog? An empirical investigations of the task technology fit model." *In 11th Pacific-Asia conference on information systems*.
- [68]. Shin, D. H. (2009). "Understanding user acceptance of DMB in South Korea using the modified technology acceptance model." *International Journal of Human- Computer Interaction*, 25(3), 173–198.
- [69]. Siau, K. and Shen, Z. (2003), "Building customer trust in mobile commerce", *Communications of the ACM*, Vol. 46 No. 4, pp. 91-4.
- [70]. Suoranta, M. (2003), "Adoption of Mobile Banking in Finland." Doctoral dissertation. Jyväskylä University Printing House, Jyväskylä and ER-paino, Lievestuore
- [71]. Tsalgatidou, A. and Pitoura, E. (2001), "Business models and transactions in mobile electronic commerce: Requirements and properties." *Computer Networks* 37, 221–236.
- [72]. Turban, E., King, D., Viehland, D., & Lee, J. (2006). "Electronic commerce 2006: A managerial perspective." New Jersey: Pearson Education.
- [73]. Taylor, S., & Todd, P. A. (1995a). "Understanding information technology usage: A test of competing models." *Information Systems Research*, 6(2), 144–176.
- [74]. Taylor, S., & Todd, P. A. (1995b). "Assessing IT usage: The role of prior experience." *MIS Quarterly*, 19(4), 561–570.
- [75]. Venkatesh, V., Morris, M. G., Davis, G. B., & Davis, F. D. (2003). "User acceptance of information technology: Toward a unified view." *MIS Quarterly*, 27(3), 425–478.
- [75]. Wang, Y. S., Lin, H. H., & Luarn, P. (2006). "Predicting consumer intention to use mobile service." *Information Systems Journal*, 16, 157–179.
- [76]. Wu, J. H., & Wang, S. C. (2005). "What drives mobile commerce? An empirical evaluation of the revised technology acceptance model." *Information & Management*, 42(5), 719–729.
- [77]. Zhou, T., Lu, Y. and Wang, B. (2010), "Integrating TTF and UTAUT to explain mobile banking user adoption", *Computers in Human Behavior*, Vol. 26 No. 4, pp. 760-7.
- [78]. Zucker, L. (1986) "Production of trust: institutional source of economic structure," 1840–1920. In: Research in Organization Behavior, Staw B.M. & Cummings L. (eds.), pp. 53–111. JAI Press, Greenwich, CT.

# Mobile Air Quality Index Monitoring System

*Emilija Janchevska<sup>1</sup>, Marin B. Marinov, Ivan Topalov, Georgi Nikolov<sup>2</sup>*

---

## Abstract

Air quality is a matter of considerable concern as it affects public health, the environment and the economy of developed countries. It is a very important issue in urban areas as it closely affects the health of a lot of people in compact areas. Recent research has shown that air pollution can increase the incidence of diseases and impair the quality of life. It is therefore necessary to develop systems for real-time multi-parameter environment monitoring so that timely decisions can be taken. The use of such systems allows us to make a thorough study of the levels of major pollutants and their sources. The Air Quality Index (AQI) Monitoring Systems are an important tool of communicating that risk. It informs the public of the local air pollution level, and the potential health risk it would impose. Conventional monitoring systems have significant limitations, especially with respect to the cost of their installation and maintenance. Methods based on mobile handheld devices also have limitations and usually measurements are not fully automated. Advances in modern gas sensoric and in smart systems development have made it possible to have new low-cost, precise and accessible air quality monitoring tools.

One of the major city pollutants in the main EU cities is particulate matter (PM), and measured levels are defining in calculating AQI. Recent assessments provided by the European Environment Agency indicate that exposure to atmospheric particulate matter causes approximately three million deaths per year in the world. Frequent exceedances of PM thresholds have been reported by most European Union countries, primarily in big cities and agglomerations where human exposure is correspondingly higher. The paper presents an approach for cost effective measurement of particulate matter and some other basic environment parameters in real-time. An Air Quality Index is calculated on the basis of these measurements. Preliminary prototypes and implementation challenges are discussed.

**Keywords:** air quality monitoring, Air Quality Index, particulate matter, urban sensing

---

## 1. INTRODUCTION AND MOTIVATION

According to EU official figures, every year in Europe about 225 000 people die from diseases caused by car emissions. To combat this threat, the European Union has introduced stricter laws and intends to reduce car emissions by 20% by 2020. It is quite important to gather real-time air quality information about main air pollutants, such as the concentration of nitrogen dioxide  $NO_2$  and particulate matter ( $PM_{2.5}$ ,  $PM_{10}$ ), as it can be used to support air pollution control and protect human beings from the harmful effects of air pollution. In reality, however, the number of air quality measurement stations in cities is insufficient because they are costly to build and maintain [1].

The Directive on ambient air quality and cleaner air for Europe (2008/50/EC) requires compliance with limit values, inter alia for  $PM_{10}$  and  $NO_2$ , to be achieved by Member States by 2005 and 2010, respectively. Ambient particulate matter pollution ranks 11 to 14 as a risk factor accounting for the total burden of disease across EU member states [2].

Within Europe there are several regions, which are considered to be critical, because it is expected that there it will be difficult to comply with the limit values even after the postponement period. Thus, areas within the EU where air quality limit values have been greatly exceeded in recent years and are expected to be exceeded in the future are defined as critical [3]. The main sources of information were the annual reports submitted in accordance with Commission Decision 2004/461/EC, AirBase [4] and model calculations. Nevertheless, the data available makes it possible to identify both areas where air quality problems are quite serious for certain reasons, and certain areas with problems of a more general nature. What is similar for these critical areas is that the main pollutants are  $PM_{10}$  and  $NO_2$ . The  $PM_{10}$  and  $NO_2$  levels for selected areas for the year 2009 are given in Table 1.

---

<sup>1</sup> Karlsruhe Institute of Technology, Institute for Information Management in Engineering, Karlsruhe 76131, Germany, Zirkel 2.

<sup>2</sup> Technical University of Sofia, Department of Electronics, Sofia 1756, Bulgaria, 8, Kl. Ohridski Blvd.

Table 1. Pollution levels in selected areas in 2009 [4].

City/area	NO <sub>2</sub>		PM <sub>10</sub>		Number of exceedances
	Annual mean (µg/m <sup>3</sup> )	Annual mean (µg/m <sup>3</sup> )	Annual mean (µg/m <sup>3</sup> )	Annual mean (µg/m <sup>3</sup> )	
Sofia	5-58	20-65	161		
Paris	27-96	25-59	222		
Athens	11-91	26-49	122		
Stuttgart	34-112	20-45	112		
Milan	37-80	39-47	116		
Krakow	26-70	54-61	168		
Kosice		51	168		
Lisbon	25-70	26-40	94		
London	22-107	19-35	36		
Berlin	13-63	21-39	73		

As can be seen from Table 1, Sofia has the highest annual mean value of  $PM_{10}$  and a significant number of exceedances. The situation is similar in many other cities on the Balkans, such as Athens, Skopje etc. [4]. Particulate matter is a complex mixture of solid and liquid particles present in the air. Calculating  $PM_{10}$  in urban stations and comparing the data and the real-time data is a challenge for researchers.

It is important to make accurate real-time monitoring of the air quality in urban areas as air quality affects citizens' health and necessitates taking timely public decisions to counteract any negative consequences. However, citizens do not often have the opportunity to obtain relevant air quality data. Practically, the equipment used to monitor air quality is usually placed in large and expensive sensing stations in strategic locations, and is managed by public authorities. Therefore, monitoring is limited to a few designated areas and sometimes citizens do not have access to the measurements gathered in this way.

Advances in embedded systems and new gas sensors technologies make it possible for a new generation of low-cost air quality monitoring systems to emerge. Low cost air quality sensors drive the development of new electronic technologies, which are increasingly widely accepted and implemented. The portable and autonomous sensors have the potential to take measurements with sufficient accuracy and in this way to capture effectively the spatial variability of air pollutants. The number of these commercially available devices has increased considerably over the last five years although the quality of the data which they provide is still questionable [5].

The main goal of our study is to develop low-cost, mobile, air quality sensor nodes and to investigate whether such systems can provide reliable results and indications about air quality and can be used in practice. This approach should provide easier access to air quality monitoring data to a wider audience of citizens, scientists and control authorities.

## 2. AIR QUALITY INDEX SYSTEMS

AQI is a number used by government agencies to assess the quality of the air at a certain location. Computing the AQI usually requires real-time data about the air pollutant concentrations from the monitoring equipment. The function used to convert air pollutant concentration to AQI varies from pollutant to pollutant, and is different for different countries [6, 7].

The levels of one or more air pollutants, over various critical averaging periods are recorded by the air quality index (AQI) or air pollution index (API) systems and are then compared with a defined reference, produced on the basis of the national or regional air quality standards. The measurement of the concentrations of main pollutants is made at fixed intervals through a network of stationary air quality monitoring stations. The measurement of street-level pollutant concentrations is made by monitoring stations located at the roadside or other point of interest (POI). In some big cities (e.g. Paris), there is a traffic index reported in addition to the general AQI.

Although the AQI systems developed by different countries or regions differ, they all show the state of the air quality in a specific area or region, and report the health risk associated with that state. AQI systems are designed with the purpose to inform members of the public what effect air quality may have on their health in the short-term.

There are different ways of calculating the Air Quality Index. Some of the most widely used indexes are: Brussel's POLLUMETER, the German index, the French ATMO, UK, South African index, US EPA's AQI etc. The most common index is a scale, where the measurements are made on an hourly, daily and annual level. To calculate the hourly index, a measurement should be taken every hour. The value of the daily index is based on the level of concentration of the pollutant on a daily level, the maximum hourly concentration during one day. The calculation is made once a day [8].

## 2.1. Main air pollutant

Certain air pollutants are widely used for estimation of the air pollution level in a lot of countries. The U.S. Environmental Protection Agency (EPA) has set the national air quality standards for six common air pollutants (also called the criteria pollutants): carbon monoxide (**CO**), ozone (**O<sub>3</sub>**), lead (Pb), nitrogen dioxide (**NO<sub>2</sub>**), sulfur dioxide (**SO<sub>2</sub>**) and particulate matter (PM). These pollutants can damage health, harm the environment and cause property damage. On the basis of the measured main pollutant concentrations the *Air Quality Index* can be calculated. A brief summary of the main air pollutants and their sources is given in Table 2.

Table 2. Main air pollutant and their sources [9, 10].

Pollutant	Sources
CO	gas heaters, leaking chimneys, woodstoves, fireplaces, gas stoves
NO <sub>2</sub>	kerosene heaters, unvented gas stoves, heaters, tobacco smoke
SO <sub>2</sub>	fuel combustion (high-sulphur coal); electric utilities and industrial processes; natural sources such as volcanoes.
CO <sub>2</sub>	gas heaters, tobacco smoke, woodstoves, fireplaces, gas stoves, automotive products

## 2.2. Common Air Quality Index in the European Union

The European Union has recently adopted the Common Air Quality Index (CAQI). It comprises three different indices – hourly, daily and annual – which are used to show air quality conditions in European cities and makes it possible to compare them easily. The measurements include both background and roadside situations. The first two indices – the hourly and daily ones - are represented by a 5-level scale, ranging from 0 (very low) to >100 (very high) (Table 3). The calculation is based on the concentrations of the three main pollutants that cause major concern about public health - **PM<sub>10</sub>**, **NO<sub>2</sub>**, and **O<sub>3</sub>**. [11].

Table 3. 5-level scale of Common Air Quality Index.

Pollution	Index Value	Color Code
Very Low	0 / 25	■
Low	25 / 50	■
Medium	50 / 75	■
High	75 / 100	■
Very High	> 100	■

The annual index reveals the air quality situation in a certain city throughout the year, with reference to the EU standards, and also the effect of long-term exposure to air pollution. The annual index is compared to the EU annual air quality standards and objectives. With an index value higher than 1, the limit values of one or more pollutants are not met. With an index value below 1, on the whole, the limit values are considered to be met.

It should be pointed out that the CAQI is a standards-based system ‘designed to give a dynamic picture of the air quality situation in each city but not for compliance checking’ [8, 12].

## 2.3. Air Quality Index Calculation in the Proposed System

The system we propose is based on low-cost gas sensors and does not reach the quality level as it has been prescribed by the legislation. The system aims to provide useful indications about air quality in specific locations. In order to do that we have defined a simple Air Quality Index calculation algorithm which will provide us with an understandable and easy to read measurement of the air pollution level whose Index Values correspond to those set by the Common Air Quality Index. The interpretation of the value is quite simple: the higher the index value, the more polluted the air is. For calculating AQI, the concentrations of several air pollutants are taken into account and compared to the limits set by the government regulations.

Assuming that we are monitoring *n* polluting gases (**PG**), the AQI is calculated by comparing the average gas concentrations, measured on a particular day, to the limit values specified by national regulations, as follows:

$$AQI = \max \left[ \frac{PG_1^n}{PG_{lim}^n}, \frac{PG_2^n}{PG_{lim}^n}, \dots, \frac{PG_n^n}{PG_{lim}^n} \right] \cdot 50. \quad (1)$$

For each pollutant gas  $PG_i$  (with  $i$  ranging from 1 to  $n$ ), the  $PG_i^m$  concentration is calculated from the measurements reported throughout the day with a consideration for the averaging period as specified by the regulations. The allowed  $PG_i^{lim}$  concentration limit is used for the calculation. The concentration of each considered pollutant is divided by its reference limit. Then, the AQI is chosen from the obtained calculations as the highest value (corresponding to the pollutant with the highest concentration).

In the current implementation we measure only the  $NO_2$ ,  $CO$ ,  $O_3$  and  $PM_{10}$  concentrations. Limit values  $PG_i^{lim}$  and averaging periods for these pollutants, as defined in [13], are presented in Table 4.

Table 4. Averaging periods and limit values.

Pollutant	Averaging Period	Limit values $PG_i^{lim}$
Nitrogen dioxide $NO_2$	maximum hourly average	$200 \mu g/m^3$
Carbon monoxide $CO$	daily maximum 8-hour average	$10 mg/m^3$
Ozone $O_3$	maximum hourly average	$180 \mu g/m^3$
PM10	24 hours	$50 \mu g/m^3$

### 3.SYSTEM ARCHITECTURE

In this section, we present a brief overview of the architecture of the implemented air quality monitoring System called *OutSense*. Further details are given in [1]. As shown in Figure 1, it includes several basic components: sensor nodes, wireless routers, a server and end devices.

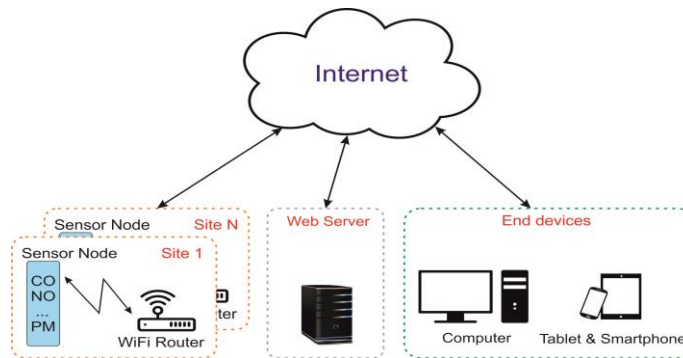

Figure 1. System architecture

The sensor nodes measure the concentration of the main air pollutants and send the acquired data to the web server. To extend the node battery life a mechanism which alternates active and sleep periods is used.

After a warm-up period each sensor node goes into a measuring mode. The GPS module is powered up and the procedure of measuring is started at the same time for all sensors. Every parameter is measured 10 times and an average of all values is taken, thus reducing the noise. The maximum measurement time of all 10 readings for all the sensors is less than 60 seconds. After the GPS location and time value have been received, and the sensor readings are available, a sleep command is sent to all sensors and the GPS module. The data received is sent through the Wi-Fi module and also recorded on the node's SD Card.

There are options for selecting different modes of operation of the whole node – constant measurement and transmission of data or measurement of data every 10 minutes. The first mode is appropriate when the node is attached to a vehicle where there is a constant power source, while the second mode is more suitable for battery operated locations.

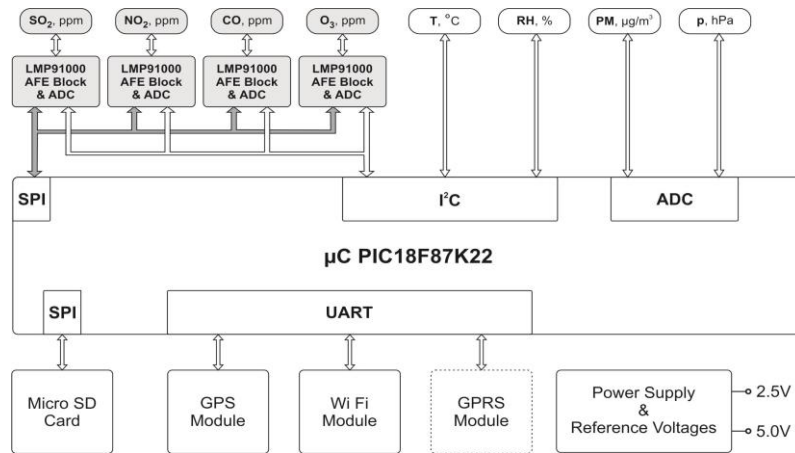

Figure 2. Main components of the sensor node.

For the carbon monoxide concentration measurement we have used a sensor CO-AF from Alphasense with a range of 0 to 5000 ppm, for nitrogen dioxide – NO<sub>2</sub>-A42F sensor and for ozone – OX-A421.

Sharp's GP2Y1010AU0F is an optical air quality sensor, designed to sense dust particles. An infrared emitting diode and a phototransistor are diagonally arranged into this device, to allow it to detect the reflected light of dust in air. It is especially effective in detecting very fine particles like cigarette smoke, and is commonly used in air purifier systems. The sensor has a very low current consumption (20mA max, 11mA typical), and can be powered with up to **7 VDC**. The output of the sensor is an analog voltage proportional to the measured dust density, with a sensitivity of **0.5V/0.1mg/m<sup>3</sup>**.

For the relative humidity we have used a sensor HDC1050 from Texas Instruments with relative humidity accuracy of **±3%**. The pressure is measured by the integrated pressure sensor from NXP Semiconductors - MPXA6115A which is a device with an analog output. As for the temperature we have used a sensor provided by Microchip - MCP9808, which is a digital sensor with an accuracy of **±0.25°C**.

## 4. EXPERIMENTAL RESULTS

### 4.1. Calibration of the Sensor Nodes

In order to test the sensor system, a number of in-situ tests were performed. Several sensor nodes were installed in different urban areas of Sofia, Bulgaria. Before the start of the in situ measurements a co-location calibration of the gas sensors was carried out. This method has been proposed in other studies and in some cases gives better results than laboratory calibrations [5, 14]. In this particular case, for the purpose of the co-location calibration, the sensor nodes used in the experiment were located near Mladost fixed station. The initial calibration of the modules was done using a comparison between data acquired from five-day measurements of the nodes and the official results from the station. The calibration factors were calculated by linear adjustment of the air quality data acquired by the nodes and the automatic measurement station used as reference.

In our case not all requirements for applying ordinary linear regression (OLR) are fulfilled. When OLR cannot be used because of violations of its assumptions, an appropriate form of Deming regression may be selected. In our case all types of sensors were calibrated using Deming regression. Deming regression accounted for uncertainties in both the sensors and the reference analyzers as there is variability not only in the sensors but also in the reference instruments. Deming regression is the term used in laboratory medicine to refer to linear regression analysis in which the random error of both the comparative and test methods is taken into account [15]. For the physical parameters sensors a modified single point calibration was performed [16].

### 4.2. Validation of the measurements

The tested nodes were placed close to the locations of two fixed automatic stations for air quality monitoring (Sofia-Drujba and Sofia-Mladost). We chose those automatic stations for the test in order to investigate the impact of traffic on air quality – station Sofia-Drujba is near a road with medium traffic whereas station Sofia-Mladost is positioned near a main road with heavy traffic. To validate the accuracy of the acquired results we compared them with the local control authority measurements on a daily basis. The authority measurements are made continuously and published daily on a website [17].

The comparison of some of the measurements, performed with a sensor node, which was positioned at a distance of less than **150m** away from the automatic measurement Sofia-Mladost station of the control authority, are presented in the figures below.

As can be seen from the results of measurement of two main pollutants in Figures 3 and 4, the values obtained by our sensor node in most cases are quite close to those of the control authority.

When we compare the measurements of the **NO<sub>2</sub>** levels we can see that the amperometric **NO<sub>2</sub>** sensor follows closely the reading of the authority station. There are only 2 significant deviations during the 24 hours' time period, for unknown reasons. The levels of the absolute error in most measurements do not exceed **±20µg/m<sup>3</sup>**. The estimated correlation coefficients



between the data obtained by the nodes and those provided by the control authorities have values between 0.45 and 0.60, which indicates a relative satisfactory linear relationship between them.

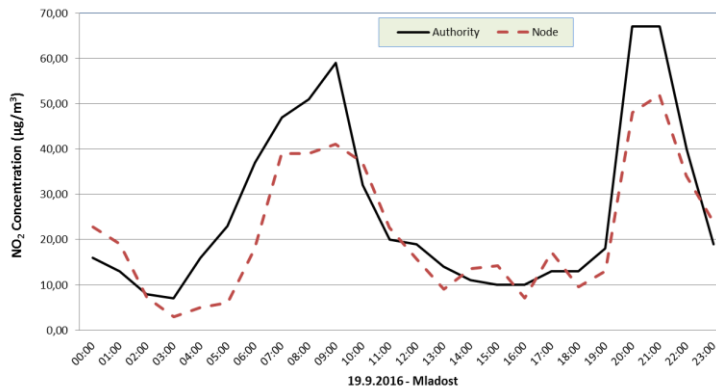

Figure 3. NO<sub>2</sub> measurements in the city area Sofia-Mladost, Bulgaria

When we compare the measurements of the PM<sub>10</sub> levels we can see that the values of the absolute error in most measurements do not exceed ±15µg/m<sup>3</sup>. Higher values of the error (up to 25 µg/m<sup>3</sup>) are observed only at lower levels of the measured parameter (in Figure 3 with the measurements at 4, 12 and 23 hours).

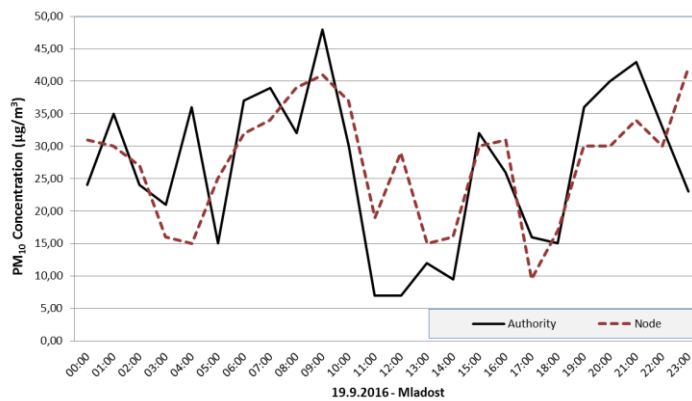

Figure 4. PM<sub>10</sub> measurements in the city area Sofia-Mladost, Bulgaria

## 5.CONCLUSION AND FUTURE WORK

In this study we present the preliminary results about the quality of the data obtained by low cost sensors and compare them with the results reported by the official authority stations. The OutSense system has been tested through an in-situ experiment, in different urban areas with different pollution profiles for 24 hour periods. The experimental measurements compared with the values provided by the official environmental control authorities show that the measurements obtained from low-cost sensors are not as accurate as official data but they can still provide useful indications of air quality in a specific location.

The precision achieved after the so called co-location calibration is comparable with the precision after calibration in laboratory conditions. The co-location calibration can be considered as a valuable tool in the next generation of mobile air quality monitoring. This is what makes the present approach an interesting alternative for calibration of sensors to measure air parameters and will thus be the subject of our future studies.

The usage of amperometric sensors together with a programmable analog front end for low-power chemical-sensing applications provides the system with more advantages, such as, low power consumption, low cost, fast response, ability to produce real-time measurement, etc. For the next hardware realization of the sensor module a next generation amperometric sensors, which are optimized for mobile applications, will be used. The system will be extended with a new sensor for precise particulate matter classification and concentration measurement.

## REFERENCES

- [1] M.B. Marinov, I. Topalov, E. Gieva and G.Nikolov, "Air Quality Monitoring in Urban Environments ,," in *39th International Spring Seminar on Electronics Technology* , Pilsen, Czech Republic, 18–22 May 2016.
- [2] *Directive 2008/50/EC on ambient air quality and cleaner air for Europe*, Brussels: European Parliament and of the Council , 2008.
- [3] M. Viana, Ed., *Urban Air Quality in Europe*, Berlin Heidelberg : Springer-Verlag , 2013.
- [4] European Environment Agency, "AirBase - The European air quality database," 2016. [Online]. Available: <http://www.eea.europa.eu/data-and-maps/data/airbase-the-european-air-quality-database-3>.
- [5] R. Williams, R. Long, M. Beaver et al., "Sensor Evaluation Report," Environmental Protection Agency, Office of Research and Development, Washington, DC, May 2014.
- [6] U.S. Environmental Protection Agency, "Air Quality Index - A Guide to Air Quality and Your Health, EPA-456/F-14-002," Office of Air Quality Planning and Standards, February 2014.
- [7] "About the Air Quality Health Index," Environment Canada - Air , Ec.gc.ca. 2013-07-16, Retrieved 2015-03-20.
- [8] W. T. Wai, "A Study of the Air Pollution Index Reporting System - final report," The Chinese University of Hong Kong, Hong Kong, 2012.
- [9] U.S. Environmental Protection Agency, "Air Pollution Monitoring," [Online]. Available: <http://www.epa.gov/airquality/montring.html>. [Accessed 09 April 2015].
- [10] Sukwon Choi, Nakyoung Kim, Hojung Cha, and Rhan Ha, "Micro Sensor Node for Air Pollutant Monitoring: Hardware and Software Issues," *Sensors*, vol. 9, pp. 7970-7987, 2009.
- [11] *Air Quality in Europa*, EEA - European Environmental Agency, 2015.
- [12] "Common Air Quality Index," European Union, 2016. [Online]. Available: <http://www.airqualitynow.eu>.
- [13] "Air Quality Standards," European Commission, 2016. [Online]. Available: <http://ec.europa.eu/environment/air/quality/standards.htm>.
- [14] S. Brienza 1, A. Galli, G. Anastasi and P. Bruschi , "A Low-Cost Sensing System for Cooperative Air Quality Monitoring in Urban Areas Sensors," *Sensors*, vol. 15, pp. 12242-12259, 2015.
- [15] D.L. Massart, B.G.M. Vandeginste, S.N. Deming et al. , *Chemometrics: a textbook*, Amsterdam : Elsevier , 2003.
- [16] Z.Kokolanski, C. Gavrovski, V. Dimcev, "Modified single point calibration with improved accuracy in direct sensor-to-microcontroller interface," *Measurement* , vol. 53, p. 22–29, 2014.
- [17] "Executive Environment Agency - Air Quality Monitoring," [Online]. Available: <http://eea.government.bg/airq/bulletin.jsp>.
- [18] "7 million premature deaths annually linked to air pollution," World Health Organisation, 2012.
- [19] "Smart City-Strategie Berlin," Senatsverwaltung für Stadtentwicklung und Umwelt - Berlin, 2015.
- [20] "Impact Analysis," European Commission, 2013.
- [21] Cliff I. Davidson, Robert F. Phalen & Paul A. Solomon, "Airbone Particulate Matter and Human Health: A Review," *Aerosol Science and Technology*, Feb 2007.

# An Ethnobotanical Study of Plants Used for Tea Making in Kosovo and Albania

*Avdyl Bajrami<sup>1</sup>, Pirro Icka<sup>2</sup>, Robert Damo<sup>2</sup>*

---

## Abstract

The paper is focused on the ethnobotanical knowledge of using the local plants for tea making (water infusions), as recreational and medicinal teas in Kosovo and Albania. The generic term “tea” (çaj) in Albanian is an important category of wild medicinal plants. At least 138 species are listed as plants that traditionally have been used for preparing refreshing hot beverages (recreational tea) and infusions for specific medicinal purposes. The most important and popular species for tea making in both areas are: *Rosa canina*, *Vaccinium myrtillus*, *Hypericum perforatum*, *Tilia cordata*, *Matricaria chamomilla*, *Sideritis* ssp., *Origanum vulgare*, and *Crataegus monogyna*. The plants usage depends on the culture of local population and many of them can be used as recreational and medicinal purpose tea. The structure of the most commonly used taxa in Kosovo is similar to those used in Albania. However, the term “çaj” or “çaj mali” (mountain tea) in northern Albania is referred to the wild oregano (*Origanum vulgare*), but also to wild thyme (*Thymus serpyllium*), and in other parts of Albania referred to *Sideritis raeseri*, whereas in Kosovo referred to *S. raeseri* and *S. scardica*. This study provides the first analysis of the use of plants for tea in both states, describing in details the parts to be used, and importance of different species.

**Keywords:** *Ethnobotany, Origanum vulgare, Sideritis, tea, traditional knowledge.*

---

## 1. INTRODUCTION

The term “ethnobotany” was first coined in 1896 by the American botanist John Harshberger as the study of plants used by primitive and aboriginal people. Since then it has been defined as the traditional knowledge of indigenous communities of the surrounding plant diversity and the study of how the people of a particular culture and region make use of indigenous plants [1]. Ethnobotany has an important role in the conservation of nature, culture, and, in particular, the biological diversity and the diversity of traditional human cultures in the world plants [1]. Human beings have been using plants since ancient times for many purposes and early on they especially developed several ways of using plant resources in order to counteract diseases [2]. Traditional use of local wild and cultivated plants for making recreational tea often borders with the medicinal use of the same plants. The people of remote areas in any region rely on local resources in order to treat various health disorders [2].

The tea began as a medicine and grows into a beverage; the Philosophy of Tea is not mere aestheticism in the ordinary acceptance of the term, for it expresses conjointly with ethics and religion our whole point of view about man and nature. It is hygiene, for it enforces cleanliness; it is economics, for it shows comfort in simplicity rather than in the complex and costly; it is moral geometry, inasmuch as it defines our sense of proportion to the universe [3]. The medicinal properties of the infusions of local plants were well known and prized by most herbalists, but it is difficult to state that the habit of drinking herbal tea as an accompaniment to one’s meal or as a social activity was a common practice before the introduction of the oriental tea [4]. The Albanian word “çaj”, probably comes from the Chinese *tscha* (pronounced “tai”, “c’a” or “chai” [5]. Tea was introduced into Europe in 1606 by the Dutch East India Company [4], [5] at the beginning of the seventeenth century, under the name *thee*, this term eventually entered into use in rest of world [5]. In the early usage the term ‘tea’ means an infusion prepared with *Camellia sinensis* (L) leaves and boiling water, now for any other infusion prepared with herbs. In many countries is not clear that term tea is used to denote a decoction or infusion made of herbs for medicinal purposes, for that purpose the technical term “recreational tea” was proposed to describe “herbal beverages prepared as infusions that are consumed in a food context for their general social and/or recreational value or for their general attributions of being “healthy” drinks [6]. World-wide, it is estimated that up to 70,000 species are used in folk medicine out of the WHO reports over 21,000 plant taxa used for medicinal purposes, among 250.000-300.000 of flowering plants used by man [7].

Albania and Kosovo have a reach flora although they have a restricted area. Albania is a country of rich natural genetic diversity of medicinal and aromatic plants with more than 300 species. Albanian Flora includes about 3 250 plant species or about 30 % of European Flora, out of 30 is endemic species and about 180 sub-endemic species [8].

Kosovo retains a great biological, ecological and landscape diversity, currently are around 2,500 plant species known to make up their flora [9]. In Albania, in particular, given its complex historical vicissitudes during the past several centuries, the fact that the country remained largely isolated for most of the twentieth century and that small-scale agropastoral activities still represent the lynch-pin of subsistence economies for many people living in mountainous and rural areas [10]. Both countries given high plant diversity shown by their Plant Diversity Index 0,695 for Albania and 0,708 for Kosovo, couplet this with a

---

<sup>1</sup> Corresponding author: University “Fan S. Noli”, Faculty of Agriculture, Korçë, Albania, [bajramiavdyt@gmail.com](mailto:bajramiavdyt@gmail.com)

<sup>2</sup> University “Fan S. Noli”, Faculty of Agriculture, Korçë, Albania, [damo-ro@hotmail.com](mailto:damo-ro@hotmail.com)

good Index of Biocultural Diversity (IBCD-RICH) 0,432 for Albania and 0,409 for Kosovo [11]. In both countries the term “çaj” is used to denote a decoction or infusion made of herbs for medicinal purposes, there has not been a specific technical term for denoting herbal tea used without clear medicinal indications.

Our main objective of this review research is to assess the available information on plants used for recreational tea purposes in Albania and Kosovo.

## 2.MATERIALS AND METHODS

This review research is made by collection of a large amount of information gathered and recorded for tea making species in Albania and Kosovo. For determining the species, we have used literature as [9], [10], [12] – [21]. The paper is focused in Albania and Kosovo due to the same linguistic and tradition that have these two countries. The term tea in Albanian does not make difference on how is prepared the tea, as decoction or infusion. This is the reason that we listed all the plant used for tea making regardless of mode of tea making.

## 3.RESULTS AND DISCUSSION

The lack of ethnobotanical studies in all regions of Albania makes this study incomplete; although in this study we found 138 tea making plants we believe that this number can be higher. In the table 1 are listed the plants that are used for tea making in Albania and Kosovo and the medical use of them.

From the table we can see that people living in Albania and Kosovo have a good knowledge of plant usage for medical and recreational purpose. At least 138 plants are known to be used for tea making. These plants belong to 56 different families. The family *Lamiaceae* was the most dominant with 19 species, followed by *Rosaceae* with 18 species, *Asteraceae* with 10 species, *Fabaceae* with 8 species, the other families have mostly one member.

Table 1. Plant used for tea making in Albania and Kosovo

Botanical taxa	Albanian folk names	English names	Parts used	Popular use	Reference
<i>Abies</i>	Bredhi	Fir	Resin	cough	21
<i>Achillea millefolium L.</i>	Lule bardhë, lule gjizë, barpezmi mijëfletësh	Yarrow	Flowering aerial parts	Diarrhea, hemorrhoids, epistaxis, anti-coagulant, anti-cholesterolemic carminative, spasmolytic, stomachache	9, 15, 17, 18, 20, 21
<i>Aesculus hippocastanum L.</i>	Gështenja e egër	Horse chestnut	Fruits	Anti-haemorrhoidal	9, 15
<i>Agrimonia eupatoria L.,</i>	Podiqja e egër	Church steeples	Aerial parts	Headache, diarrhea, anti-allergic, anti-inflammatory	17, 20
<i>Agropyron repens (L.) Beauv.</i>	Bari i magarit	Couch grass	Aerial parts	Anti-hemorrhoidal, respiratory system and urinary disorders	15, 20
<i>Alchemilla vulgaris L.</i>	Alhemila	Lady's mantle	Aerial parts	Improve fertility in women	20
<i>Allium cepa L.</i>	Qepa	Onion	Bulb	Antitussive, sore throat	9, 15
<i>Althaea officinalis L.</i>	Mullagë e bardhë	Marsh mallow	Flowers	Anti-tussive, expectorant	15, 20
<i>Althea rosea L.,</i>	Mullaga e butë	Mallow	Leaves	The common cold, bronchitis.	17
<i>Apium graveolens L.</i>	Kereviz	Celery	Aerial parts Roots	To treat sterility, diuretic, appetizing	20
<i>Arctium lappa L.</i>	Rrodhe	Greater burdock	Areal parts,	Gastrointestinal disorders bronchitis, lithontriptic	15
<i>Arctostaphylos uva-ursi</i>	Çaj uvin, rrush arushë	Bearberry	Leaves, aerial parts	Urinary tract infections, prostatitis	20, 21
<i>Artemisia absinthium L.</i>	Pelin, pelin i bardhë	Wormwood	Aerial parts	Cardiotonic, fever, malaria, anti-anemic, antimalarial, anti-parasitic, relaxant, stomachache, anti-diabetic, appetite stimulant, expectorant	9, 10, 15, 20, 21
<i>Asplenium trichomanes L.</i>	Fier guri	Maidenhair spleenwort	Aerial parts	To treat kidney stones, diuretic, back pain	10, 12, 14, 17
<i>Avena sativa L.</i>	Thekra	Oat	Aerial parts	Skeletal system enhancement	20
<i>Bellis perennis L.</i>	Lule dele, lule shqerre	Common daisy	Flowers	Inflammation of the upper respiratory tract.	9, 17
<i>Betula pendula Roth</i>	Mështekna	Birch	Leaves	Diuretic, edema, urinary disorders, lithontriptic	9, 10, 20
<i>Buxus sempervirens L.,</i>	Bushi, shemshiri	Boxwood	Leaves, Bark (cortex)	Anxiety	17

<i>Capsella bursa-pastoris</i> (L.) Medik.	Më do s'më don	Shepherd's purs	Aerial parts	Anticoagulant	15, 20
<i>Castanea sativa</i> Mill.	Gështenja	Sweet chestnut	Flowers, cortex	Anti-anemic, bronchitis, anti-tussive	20
<i>Centaurea cyanus</i> L.	Kokoçelli	Cornflower	Flowers	Hepatitis, respiratory disorders	17, 20
<i>Centaureum erythraea</i> Rafn	Kantarioni i kuq, bari i etheve	Common centaury	Flowering, aerial parts	Anticoagulant, anti-pyretic, appetizing, anti-anemic, fever stomachache, digestive discomforts	9, 20, 21
<i>Chelidonium majus</i> L.	Bar saralleku, tamblagjaku	Greater celandine	Aerial parts	Hepatitis, cholecystitis,	12, 14, 15, 17
<i>Cichorium intybus</i> L.	Çikorja	Common chicory	Aerial parts, root	Hepatic disorders, hart disorders, atherosclerosis	9, 20
<i>Cornus mas</i> L.	Thana	Cornelian cherry, dogwood	Fruits	Diarrhea, cough, cardiogenic, diuretic, stomachache, anti-anemic, anti-hypertensive, anti-hemorrhoidal, anti-diabetic, to improve the blood circulation	9, 10, 19, 20
<i>Corylus avellana</i> L.	Lajthi	Hazel	Leaves	Anti-tussive, hepatic disorders, anti-diabetic, anti-anaemic	9, 20
<i>Cotinus coggygia</i> Scop.	Ruj	Smoke tree	Leaves, fruits	Stomach disorders, kidney disorders, anti-diarrheal	20
<i>Crataegus sericea</i>	Murriz, murriz e madhe	Hawthorn	Leaves and fruits	Headache, hypertension	10, 21
<i>Crataegus monogyna</i> Jacq.	Murriz, murriz i vogël	Hawthorn	Flowers, fruits	Cough, fatigue, adjuvant for cardiac arrhythmias, hypertension, neurorelaxant, anti-cholesterolemic, neuro-relaxant, anti-diabetic, heart pulse regulator, fever	9, 10, 15, 17, 20
<i>Cucurbita pepo</i> L.	Kungulli	Pumpkin	Leaves	Sour throat, antitussive, kidney inflammations, intestine infections, anti-diarrhoeal	9
<i>Cydonia oblonga</i> Mill	Ftoi	Quince	Leaves	Digestive, cough, fever, anti-diarrheal	10, 15, 20
<i>Cynodon dactylon</i> Pers.	Grami	Vilfa stellata	Aerial parts	Cystitis, urethritis, urinary gravel and nonobstructive stones	15, 17
<i>Dipsacus fullonum</i> L.	Bari për hemoroide	Teasel	Flowers	Anti-haemorrhoid	9
<i>Equisetum arvense</i> L.	Bishtkali	Horsetail	Aerial parts	Diuretic, prostatitis, kidney infections, hemorrhoids, epistaxis, hepatic disorders	10, 17, 20
<i>Erythraea centaurium</i> Pers.,	Kinëfusha	European centaury	Aerial parts	To treat anemia	17
<i>Foeniculum vulgare</i> Mill	Kopër	Fennel	Fruits	Eye disorders, galactagogue, spasmolytic	20
<i>Fragaria vesca</i> L.	Dredhza	Wild strawberry	Fruits	Digestive, spasmolytic	20
<i>Fraxinus excelsior</i>	Frashër	Ash	Bark	Drunk for relieving skin burns	21
<i>Fumaria officinalis</i> L.,	Lule pëllumbi	Drug fumitory	Aerial parts	To treat metrorrhagia, diuretic, relaxant,	17, 20
<i>Galega officinalis</i> L.	Ballbreshke, kukurjaku	Galega	Aerial parts	To promote the secretion of milk in nursing mother	17
<i>Galium verum</i> L.	Ngjitës pranveror	Yellow bedstraw	Aerial parts	Anti-hypertensive, kidney disorders, skin regeneration	20
<i>Genista tinctoria</i> L.,	Gjineshtra ngjyruese	Dyer's greenweed	Aerial parts	Inflammation of urinary tract	17
<i>Gentiana lutea</i> L.	Bar zemre, geciana	Gentiane	Aerial parts	Cardiotonic, digestive disorders	10, 20, 21
<i>Geranium sanguineum</i> L.	Zdrvac	Bloody geranium	Aerial parts	Respiratory disorders, laryngitis	20
<i>Geum urbanum</i> L.	Shtërnguesi	Wood avens	Roots	Anti-haemorrhoid	9
<i>Hedera helix</i> L.	Urthi	Common ivy	Leaves	Nonobstructive gallstones	17
<i>Humulus lupulus</i> L.	Bari sherbetit, sumbullari	Common hop	Aerial parts	Insomnia, appetizing, prostate, neurorelaxant, diuretic	15, 20

<i>Hypericum perforatum L.</i>	Lulebasani, çaj bjeshke, çaj i egër, çaj mali, çaj i verdhë, çaj moskovë	St. John's Wort	Flowering, aerial parts	Stomach and digestive disorders, ulcerative colitis, anti-anemic, anticoagulant, neurorelaxant, antacid, genital infections, anti-diabetic	9, 10, 17, 18, 19, 20, 21
<i>Hypericum maculatum Crantz</i>	Balsam, çaj verdhe, çaj kuq çaj bjeshke	Imperforate, St. John's wort	Aerial parts while flowering	To treat abdominal pains, especially in children.	12, 13, 14
<i>Ilex aquifolium L.</i>	Gjemb ariu	Holly	Leaves	Diuretic, kidney stones, stomach-ache (rare), panacea	10
<i>Inula helenium L.,</i>	Bari i plevitit	Elecampane	Aerial parts, roots	Hemorrhoids, anti-tussive, bile simulation, diuretic	17, 20
<i>Juglans regia L.,</i>	Arra	Common walnut	Leaves	Diarrhea, anticholesterolemic, anti-diabetic	9, 17
<i>Juncus acutus L.,</i>	Zhuga	Spiny rush	Aerial parts	Inflammations of urinary tract	17
<i>Juncus effusus L.</i>	Xuklla	Com. rush	Aerial parts	Urinary tract disorders	20
<i>Juniperus communis L.</i>	Dëllinja	Juniper	Cones and young branches, fruits	Diuretic, lithontriptic, menstrual pains. tuberculosis, anti-rheumatic, anti-asthmatic, anti-diabetic	9, 10, 20
<i>Juniperus oxycedrus L.</i>	Dëllinjë	Juniper	Cones	Diuretic	10
<i>Lamium album</i>	Hithëbutë	White nettle	Aerial parts	Kidney problems	21
<i>Laurus nobilis L.,</i>	Dafina	Laurel	Leaves	Cold, cough, rhinitis, edema.	17
<i>Leonurus cardiaca L.</i>	Ayslan kuyrgu	Common motherwort	Aerial parts	Cardiotonic,	20
<i>Ligustrum vulgare L.</i>	Shemëshir	Common privet	Stem, leaves	Lithontriptic	9
<i>Lilium martagon L.</i>	Bar tëmthi	Turk's cap lily	Tubers	Liver disease	12
<i>Lythrum salicaria L.,</i>	Bargjaku	Purple loosestrife	Aerial parts	Metrorrhagia	17
<i>Malus sylvestris Miller</i>	Diviakça, mollë e egër	Crab apple, European wild apple	Fruits	Appetite stimulant, headache, anti-hypertensive, anti-diarrhoeal	9, 10
<i>Malva sylvestris L.</i>	Mëllaga, lule gjaku	Common mallow	Leaves, flowering tops	Diuretic, anti-tussive, bronchitis, antimicrobial, aocolithic sore throat	9, 20, 21
<i>Matricaria chamomilla L.</i>	Kamomili	Chamomile	Flowers, aerial parts	Stomachache, sedative (for insomnia), pediatric diarrhea, abdominal pains, oral cavity infections, anti-hemorrhoidal, anti-tussive, anti-bacterial, relaxant recreational, sinusitis, antimicrobial, infections of the digestive and urinary tract	9, 12, 17, 20, 21
<i>Melissa officinalis L.</i>	Çaj blete, milc Bar blete	Lemon balm	Aerial parts	Digestive, cardiotonic, neurorelaxant, anti-hypertensive, headache, intestinal cramps, bronchitis, anti-anemic, respiratory disorders, appetizing, recreational/panacea, cough, mild tranquilizer	10, 17, 18, 20, 21
<i>Melissa officinalis L.</i>	Çaj nana,	Horse mint	Aerial parts	Bronchitis, stomach disorders, carminative, respiratory system infections, anti-tussive,	20
<i>Mentha pulegium L.</i>	Mendër e egër, menta e egër	Mint	Aerial parts	Neurorelaxant, improve blood circulation, respiratory system infections, antitussive, cough, fever, recreational/panacea, sore throat, stomachache	20, 21
<i>Mespilus germanica L.</i>	Mushmolla	Common medlar	Aerial parts	Anti-diarrheal, anti-diabetic	20
<i>Morus alba L.</i>	Mani i bardhë	White	Leaves	Anti-diabetic	20

		mulberry			
<i>Morus nigra L.</i>		Black mulberry	Leaves	Anti-diabetic	9
<i>Nepeta cataria</i>	Nepetë dliiruese, milc i egër	Catnip	Flowering aerial parts	Stress, fears, digestive discomfords	17
<i>Ocimum basilicum L.</i>	Borzilok	Basil	Aerial parts	Carminative, kidney infections, tuberculosis, colds/flu	20, 21
<i>Ononis spinosa L.</i>	Therrë leपुरi	Spiny rest harrow	Flowers	Anti-diabetic, renal disorders, lithonhopic	9
<i>Orchis morio L. and other Orchis spp.</i>	Salep	Wild orchid	Tubers	Cough, stomach disorders, anti-diarrhoea, to improve fertility in men, panacea, helminthiasis	9, 10, 12, 13, 18, 19, 20
<i>Origanum hirtum (Link.), Ietswaart,</i>	Rigoni i bardhë	White oregano	Aerial parts	Inflammatory and spastic conditions of upper respiratory tract, gastrointestinal disorders	17
<b><i>Origanum vulgare L.</i></b>	Çaj, lule çaji, çaj mali, çaj i egër, çaj fushe, çaj bjeshke, çaj rigoni, rigon	Oregano, red oregano, wild oregano	Flowering aerial parts	Digestive, flu, panacea, cough, fever, headaches, hanti-hepatitis, stomachache sore throats and colds, respiratory system infections, sedative	9, 10, 12, 13, 14, 15, 18, 19, 20, 21
<i>Paliurus aculeatus Lam.,</i>	Driza	Christ's thorn	Fruits	Diarrhea	17
<i>Papaver rhoeas L.</i>	Lulëkuqja	Red poppy	Flowers	Insomnia, Antitussive	9
<i>Petroselinum crispum (Mill.) Fuss</i>	Majdanoz	Parsley	Aerial parts	Diuretic, prostatitis, anti-cholesterolemic, anti-diabetic, anticoagulant	10, 20
<i>Phaseolus vulgaris L.</i>	Fasule	Common bean	Aerial parts	Anti-diabetic	20
<i>Phyllitis colopendrium L</i>	Bar mushknisë	Hart's tongue fern	Leaves	Treat respiratory and lung affliction	8, 12, 19
<i>Pimpinella anisum L.</i>	Bar i gjirit	Aniseed	Aerial parts	Spasmolytic, carminative, anti-ageing, galactagogue	20
<i>Plantago major L.</i>	Gjethe delli	Common plantain	Leaves, flowers stems	Urogenital infections, wound healing, digestive disorders, diuretic, abdominal pains, haemostatic, antibacterial.	9, 13, 14, 12, 17, 18, 20
<i>Plantago media L.</i>	Gjethe delli mesatar	Hoary plantain	Leaves	Diuretic, haemostatic, antibacterial.	17
<i>Polygonum avicularae L.</i>	Bar pate, bar thek	Common knotgrass	Aerial parts	Inflammation of urinary tracts, urinary calculi, anti-coagulant	17, 20
<i>Populus alba L.</i>	Plepi	Silver poplar	Leaves	Urinary tract disorders	20
<i>Populus nigra L.</i>	Plepi	Lombardy poplar	Leaves	Anti-tuberculosis	9
<i>Primula veris L.</i>	Aguliçe, lulja e goliqit	Primrose, cowslip	Flowers, aerial parts	Headache, stomachache and flu, cough, respiratory system disorders, improve blood circulation, bronchitis	9, 10, 12, 17, 20, 21
<i>Prunus avium L.</i>	Qershia	Cherry	Leaf peduncles	Kidney stones	12, 20
<i>Prunus cerasus L.</i>	Vishnjët	Sour cherry	Fruits	Antihypertensive	9
<i>Prunus spinosa L.</i>	Kullumbri	Sloe	Fruits, flowers, leaves	Stomachache, anti-diabetic, hepatic disorders, digestion, antihypertensive, constipation	9, 10, 20
<i>Pulmonaria officinalis L.</i>	Bar i mushkërive	Lungwort	Aerial parts	Anti-tussive, bronchitis	20
<i>Punica granatum L.,</i>	Shega	Pomegranate	Cortex	Anti-diarrheal	17
<i>Pyrus pyrastrer (L.) Burgsd.</i>	Gorrice, dardha e egër	Wild pear	Fruits	Diarrhoea, diuretic, constipation	9, 12, 18
<i>Rhamnus catharticus L.,</i>	Pjerëza dliirëse	Buckthorn	Fruits	To treat amenorrhoea	17
<i>Ribes rubrum L.</i>	Ribizla	Red currant	Fruits	Anti-rheumatic, anti-malarial, anti-allergic, heart disorders	20
<i>Robinia pseudacacia L.</i>	Bagremi	Black locust	Flowering areal parts	Respiratory inflammations	9
<i>Rosa canina L.</i>	Trëndafil i egër	Dog rose	Pseudofruits	Improve immunity, diarrhoea,	9, 10, 12,

				fever, haemorrhoids, fatigue, stomachache, cough, diuretic, anti-anaemic, hepatic, digestive tract disorders, influenza, lithontriptic, antitussive	14, 17, 18, 19, 20, 21
<i>Rubia tinctorum L.</i>	Crvenka	Aerial parts	Aerial parts	Kidney disorders, skeletal disorders, tuberculosis	20
<i>Rubus caesius L.</i>	Manaferra	Dewberry	Roots	Used to treat lung cancer	15
<i>Rubus fruticosus L.</i>	Kupina, mana	European blackberry	Aerial parts, fruits, roots	Anti-anemic, anti-diabetic, antimycotic, anti-diarrheal, kidney infections, improve blood circulation, hypertensive, anti-parasitic, antitussive	9, 20
<i>Rubus idaeus L.</i>	Mjedra, malina	Raspberry	Leaves, roots, fruits	Improve blood, circulation, anti-hypertensive, anti-diarrheal, anti-tussive, anti-pyretic, panacea, dysentery, tonsillitis, digestive disorders	20, 21
<i>Rubus ulmifolius Schott)</i>	Manaferra	Wild blackberry	Leaves	Stomachache, diarrhea, cough, used as gargle in inflammation of the throat, pharyngitis	10, 17, 21
<i>Salix alba L.</i>	Shelgu, vrba	White willow	Leaves, cortex	Hepatic disorders, antipyretic, analgesic	20
<i>Salvia officinalis L.</i>	Sherbela	Wild sage	Leaves	Sore throats, flu, tonsillitis and cough, digestive, tonsillitis and other infection of respiratory system, anti-diabetic	12, 17, 20
<i>Sambucus ebulus L.</i>	Kinla	Dwarf elderberry	Flowers	Anti-rheumatic	15
<i>Sambucus nigra L.</i>	Shtog	Elderberry	Flowers, fruits	Bronchitis, anti-asthmatic, influenza, stomach disorders, urinary tract disorders, diarrhea antitussive common cold and feverish states, improving blood circulation, sore throats	15, 17, 18, 20
<i>Satureja montana L.</i>	Çaj i egër, trumza	Savory	Flowering, aerial parts	Headache, inflammatory of the gastrointestinal tracts, anti-diabetic, anti-parasitic, respiratory tract infections, anti-tussive, expectorant	10, 12, 17, 20
<i>Sempervivum tectorum</i>	Bar veshi, burgull pullazësh	Houseleek	Inflorescences	Cough	21
<i>Sideritis raeseri Boss. et Heldr.</i>	Çaj, çaj mali	Mountain tea	Flowering, aerial parts	Cough, flu, digestive troubles, panacea, anti-ulcerogenic, stomachic, carminative, analgesic and tonic	10, 16
<i>Sideritis scardica</i>	Çaj mali	Mountain tea	Flowering, aerial parts	Recreational, panacea, cardiogenic, stomachache	21
<i>Sisymbrium officinale (L.) Scop.</i>	Ilsepika	Hedge mustard	Aerial parts	Used for treating rheumatism	13
<i>Stachys tymphaea Hausskn</i>	Çaj bjeshke, çaj i egër, çaj fushe	Glandulous Woundwort	Flowering, aerial parts	Panacea, cold and flu	18, 19
<i>Tanacetum vulgare L.</i>	Pelin i verdhë	Tansy	Aerial parts, seeds	Stomachache, digestive tract disorders anti-parasitic	20
<i>Taraxacum officinale Weber s.l.</i>	Qumështorja, lule qeni	Dandelion	Leaves, flower	Antihypertensive, diuretic, improve blood circulation, digestive and urinary tract disorders, anti-anemic, stomach pain, menstrual pain, respiratory inflammation	15, 20
<i>Teucrium chamaedrys L.</i>	Çaj i egër, çaj mali, lule mali	Germander	Aerial parts	Stomachache, fevers, appetizing, anti-hemorrhoidal, respiratory inflammation	13, 15, 20
<i>Teucrium polium L.</i>	Bar majasëlli, bar saraxha	Felty germander	Aerial parts	Colitis and hemorrhoids, stomachache, digestive tract	12, 17, 20



				disorders.	
<b><i>Thymus pulegioides L.</i></b>	Çaj i egër	Wild thyme	Flowering, aerial parts	Headache	10
<b><i>Thymus serpyllium L.</i></b>	Çaj e egër, lisë, zhumbrica	Wild thyme, breckland thyme	Aerial parts	Respiratory inflammations, bronchitis, anti-asthmatic, gastrointestinal disorders, immunostimulant, sedative, neurorelaxant, carminative, spasmolytic, influenza	12, 13, 15, 20
<i>Thymus vulgaris L.</i>	Zhumbrica	Garden thyme	Aerial parts	Anti-tussive, anti-cholesterolemic	20
<b><i>Tilia cordata Mill.</i></b>	Çaj bliri, bliri me gjethe të vogla	Lime tree, small-leaved lime	Flowers	Coughs and flu, headache, fever, colds and sore throats, hypertension, panacea, anti-bronchitis, insomnia	10, 12, 13, 15, 17, 19, 21
<i>Tilia platyphyllos Scop.</i>	Blini, lipa	Large leaf linden	Flowers	Respiratory system inflammations, anti-anemic, stomach infections, headache, anti-tussive, expectorant	20
<i>Trifolium arvense</i>	Tërfili	Rabbitfoot clover	Aerial parts	Anti-rheumatic	20
<i>Trifolium pratense L.</i>	Tërfili	Red clover	Flowers	Oral cavity antiseptic, anti-rheumatic, appetizing	15
<i>Trigonella corniculata L.,</i>	Trëndelina	Corniculate, fenugreek	Flowers	To treat high cholesterol and triglycerides,	17
<i>Tussilago farfara L.</i>	Thundërmushka, bar mushke	Coltsfoot	Leaves, flowers	Cough, expectorant, anti-tussive	12, 14, 17, 20, 21
<i>Typha latifolia L.</i>	Shava	Bulrush	Fruits	Respiratory inflammations	20
<i>Urtica dioica L.</i>	Hithra	Nettle	Aerial parts, leaves	Hemorrhoids, cystitis and urinary gravel, anti-anemic, influenza, anti-cancer, eczemas, bronchitis, headache, anti-rheumatic, anti-bacterial, digestive and urinary disorders	10, 15, 20
<i>Vaccinium myrtillus L.</i>	Boronica	Bilberry	Fruits	Anemia and heart problems, intestinal troubles, lithontriptic anti-diarrheic, blood cleansing, respiratory inflammations,	12, 13, 14, 17, 18, 19, 20
<i>Vaccinium vitis-idaea L.</i>	Brusnica	Lingonberry	Leaves, fruits, leaves	Urinary inflammations, anti-rheumatic, diuretic, antipyretic, anti-diabetic, anticonvulsant	20
<i>Veratrum album L.</i>	Shtara	False helleborine	Aerial parts	Anti-hypertensive.	20
<i>Verbascum ssp.,</i>	Netulla, bar peshku	Mullein	Flowers, aerial parts	To treat irritation dry cough, anti-tussive, digestive tract disorders, anti-haemorrhoid, respiratory and cardiac diseases	15, 17, 20, 21
<i>Verbena officinalis L.,</i>	Bar i shpretkës	Vervain	Aerial parts	To treat nonobstructive gallstones	17
<i>Veronica officinalis L.</i>	Veronikë mjekësore	Heath speedwell	Leaves	Anticoagulant, respiratory system inflammations	20
<i>Viola odorata L.</i>	Manushaqe	Sweet violet	Flowers	Antitussive	15
<i>Vitis vinifera L.</i>	Rrushë	Grape	Leaves	Increase immunity, hepatitis	20
<i>Zea mays L.</i>	Misër	Maize	Female flower	Urinary tract inflammations, edema, stomach disorders, anti-parasitic	20

In this table is shown that 14 species (in bold), in both countries, used for tea making are called “çaj” (tea), expressing the purpose of usage. These plants are: *Arctostaphylos uva-ursi*, *Hypericum perforatum L.*, *Hypericum maculatum Crantz*, *Melissa officinalis L.*, *Melissa officinalis L.*, *Origanum vulgare L.*, *Satureja montana L.*, *Sideritis raeseri Boss. et Heldr.*, *Sideritis scardica*, *Stachys tymphaes Hausskn (Stachys reinertii Heldr. ex Murb.)*, *Teucrium chamaedrys L.*, *Thymus pulegioides L.*, *Thymus serpyllium L.*, *Tilia cordata Mill.* The most important and popular species for tea making in both areas are: *Rosa canina*, *Vaccinium myrtillus*, *Hypericum perforatum*, *Tilia cordata*, *Matricaria chamomilla*, *Sideritis ssp.*, *Origanum vulgare*, and *Crataegus monogyna*.

The structure of the most commonly used taxa in Kosovo is similar to those used in Albania. However, the term “çaj” or “çaj mali” (mountain tea) in northern Albania is referred to the wild oregano (*Origanum vulgare*), but also to wild thyme (*Thymus serpyllium*), and in other parts of Albania referred to *Sideritis raeseri*, where in Kosovo referred to *S. raeseri* and *S. scardica*.

## 4. CONCLUSIONS

The study showed a remarkable level of traditional knowledge concerning the folk use of wild botanical taxa for tea making in Albania and Kosovo. At least 138 plants belong to 56 different families are known to be used for tea making in both two countries. The *Lamiaceae* family is the most dominant, followed by *Rosaceae*, *Asteraceae*, *Fabaceae* etc., where: *Rosa canina*, *Sideritis ssp*, *Matricaria chamomilla*, *Origanum vulgare*, *Crataegus monogyna*, *Hypericum perforatum*, *Tilia cordata*, etc. are the most and popular species for tea making. Further ethnobotanical studies can determinate the exact number plant used for tea making regardless of high species that we carried out from this study.

## REFERENCES

- [1] Abbasi A.M. et al., “Medicinal Plant Biodiversity of Lesser Himalayas-Pakistan”, 17 DOI 10.1007/978-1-4614-1575-6\_2, © Springer Science+Business Media, LLC, 2012.
- [2] Abbas, Z., Mulk K. S., Mehmood, A. A., Pieroni, A., Ullah, Z., Iqbal, M., Zeeshan, A. “Ethnobotany of the Balti community, Tormik valley, Karakorum range, Baltistan, Pakistan” *Journal of Ethnobiology and Ethnomedicine* (2016) 12:38.
- [3] Kakuzo Okakura “The Book of Tea” Originally published 1906 First printing 2001 by William Adams.
- [4] Sõukand, R., Quave, CL, Pieroni, A., Pardo-de-Santayana, M., Tardío, J., Kalle, R., Łuczaj, Ł., Svanberg, I., Kolosova, V., Aceituno-Mata, L., Menendez-Baceta, G., Kołodziejska-Degórska, I., Pirożnikow, E., Petkevičius, R., Hajdari, A., Mustafa, B. “Plants used for making recreational tea in Europe: a review based on specific research sites”. *Journal of Ethnobiology and Ethnomedicine* 2013, 9:58.
- [5] Pardo de Santayana, M., Blanco, E., Morales, R. “Plants known as *té* in Spain: An ethno-pharmaco-botanical review” *Journal of Ethnopharmacology* 98, 2005, 1–19 Elsevier Ireland Ltd.
- [6] Sõukand, R., Kalle, R. “Where does the border lie: locally grown plants used for making tea for recreation and/or healing, 1970s-1990s Estonia”. *Journal of Ethnopharmacology*, 2013, Volume 150, Issue 1, 162-174.
- [7] Stevanovic, ZD., Janackovic, P., Stankovic, M. “Are there still neglected medicinal plants beyond official and traditional consideration?” *Proceedings of the 8th CMAPSEEC Conference on Medicinal and Aromatic Plants of Southeast European Countries* 2014.
- [8] Ibraliu, A., Mullaj, A., Elezi, F. Shehu, J., Belul, G. “Genetic resources of medicinal and aromatic plants of Albania – current status of the national collection of maps” *Proceedings of the 8th CMAPSEEC Conference on Medicinal and Aromatic Plants of Southeast European Countries* 2014.
- [9] Mustafa, B., Hajdari, A., Pajaziti, Q., Sylva, B., Quave, C. L., Pieroni, A. “An ethnobotanical survey of the Gollak region, Kosovo”. *Genet Resour Crop Evol* 2012, 59, p. 739–754.
- [10] Pieroni, A., Ibraliu, I., Abbasi, A.M., Papajani-Toska, V. “An ethnobotanical study among Albanians and Aromanians living in the Rraicë and Mokra areas of Eastern Albania”. *Genetic Resources and Crop Evolution* (Springer), 2015, 62, 477-500.
- [11] Damo R., Icka, P., Ismaili, M. “Biocultural diversity in Albania, Macedonia and Kosovo”. *Versita/ SEEU Review* 2012, Volume 8, No.2.
- [12] Pieroni A, Dibra B, Grishaj G, Grishaj I, Maçi SG. “Traditional phototherapy of the Albanians of Lepushë, Northern Albanian Alps”. *Fitoterapia*, 2005, 76:379–399.
- [13] Pieroni A. “Local plant resources in the ethnobotany of Theth, a village in the Northern Albanian Alps”. *Genet Resour Crop Evol* 2008, 55:1197–1214.
- [14] Pieroni A. “People and plants in Lëpushë. Traditional medicine, local foods, and post-communism in a North Albanian village”. In: Pardo de Santayana M, Pieroni A, Puri R (eds) *Ethnobotany in the new Europe: people, health and wild plant resources*. Berghahn, New York, 2010, pp 16–50.
- [15] Mustafa, B., Hajdari, A., et al. “Medical ethnobotany of the Albanian Alps in Kosovo”. *Journal of Ethnobiology and Ethnomedicine*, 2012, 8:6.
- [16] Aneva Y. I., Evstatieva N. L., Zhelev, P., Papajani – Toska, V., Ibraliu, A. “Distribution of *Sideritis Raeseri* boiss. et heldr. in Albania – state of its populations and recommendations for conservation”. *Proceedings of the 8th CMAPSEEC Conference on Medicinal and Aromatic Plants of Southeast European Countries* 2014.
- [17] Papajani V, Ibraliu A, Miraçi M, Rustemi A. Ethnobotanical study of medicinal plants traditionally used in fieri district, Albania. *Proceedings of the 8th CMAPSEEC*, May 19-22, Durrës, Albania, 2014, p. 123-133.
- [18] Pieroni A, Nedelcheva A, Hajdari A, Mustafa B, Scaltriti B, Cianfaglione K, Quave CL. “Local Knowledge on Plants and Domestic Remedies in the Mountain Villages of Peshkopia (Eastern Albania)”. *J. Mt. Sci.* 2014, 11(1), p. 180-194.
- [19] Pieroni A, Quave CL. “Wild Food and Medicinal Plants Used in the Mountainous Albanian North, Northeast, and East: A Comparison”. Chapter 10 in: Pieroni A, Quave CL (eds.), *Ethnobotany and Biocultural Diversities in Balkans*, 2014.
- [20] Mustafa, B., Hajdari, A. et al. “A cross-cultural comparison of folk plant uses among Albanians, Bosniaks, Gorani and Turks living in south Kosovo”. *Journal of Ethnobiology and Ethnomedicine*, 2015, 11:39.
- [21] Pieroni, A., Sõukand, R., Quave, CL., Hajdari, A., Mustafa, B. “Traditional food uses of wild plants among the Gorani of South Kosovo” *Appetite* 108, 2017, 83-92 Available online 22 September 2016.

